



GRADE 1 MATHEMATICS

Blackline Masters

Number Cards

1

2

3

4

5

6

Number Cards (continued)

7	8	9
0	10	

Number Cards (continued)

20

30

40

50

Number Cards (continued)

60

70

80

90

Number Cards to 100

1

2

3

4

Number Cards to 100 (continued)

5

6

7

8

Number Cards to 100 (continued)

9

10

11

12

Number Cards to 100 (continued)

13

14

15

16

Number Cards to 100 (continued)

17

18

19

20

Number Cards to 100 (continued)

21

22

23

24

Number Cards to 100 (continued)

25

26

27

28

Number Cards to 100 (continued)

29

30

31

32

Number Cards to 100 (continued)

33

34

35

36

Number Cards to 100 (continued)

37

38

39

40

Number Cards to 100 (continued)

41

42

43

44

Number Cards to 100 (continued)

45

46

47

48

Number Cards to 100 (continued)

49

50

51

52

Number Cards to 100 (continued)

53

54

55

56

Number Cards to 100 (continued)

57

58

59

60

Number Cards to 100 (continued)

61

62

63

64

Number Cards to 100 (continued)

65

66

67

68

Number Cards to 100 (continued)

69

70

71

72

Number Cards to 100 (continued)

73

74

75

76

Number Cards to 100 (continued)

77

78

79

80

Number Cards to 100 (continued)

81

82

83

84

Number Cards to 100 (continued)

85

86

87

88

Number Cards to 100 (continued)

89

90

91

92

Number Cards to 100 (continued)

93

94

95

96

Number Cards to 100 (continued)

97

98

99

0

Number Cards to 100 (continued)

100	
------------	--

100 Chart

1	2	3	4	5	6	7	8	9	10
11	12	13	14	15	16	17	18	19	20
21	22	23	24	25	26	27	28	29	30
31	32	33	34	35	36	37	38	39	40
41	42	43	44	45	46	47	48	49	50
51	52	53	54	55	56	57	58	59	60
61	62	63	64	65	66	67	68	69	70
71	72	73	74	75	76	77	78	79	80
81	82	83	84	85	86	87	88	89	90
91	92	93	94	95	96	97	98	99	100

I Have ... Who Has ...? Game

I have 22.

Who has 38?

I have 38.

Who has 19?

I have 19.

Who has 35?

I have 35.

Who has 40?

I have 40.

Who has 24?

I have 24.

Who has 29?

I Have ... Who Has ...? Game (continued)

I have 29.

Who has 31?

I have 31.

Who has 36?

I have 36.

Who has 47?

I have 47.

Who has 33?

I have 33.

Who has 13?

I have 13.

Who has 15?

I Have ... Who Has ...? Game (continued)

I have 15.

Who has 28?

I have 28.

Who has 17?

I have 17.

Who has 23?

I have 23.

Who has 41?

I have 41.

Who has 12?

I have 12.

Who has 39?

I Have ... Who Has ...? Game (continued)

I have 39.

Who has 20?

I have 20.

Who has 30?

I have 30.

Who has 44?

I have 44.

Who has 27?

I have 27.

Who has 18?

I have 18.

Who has 22?

Dominoes (Total of Pips To Ten)

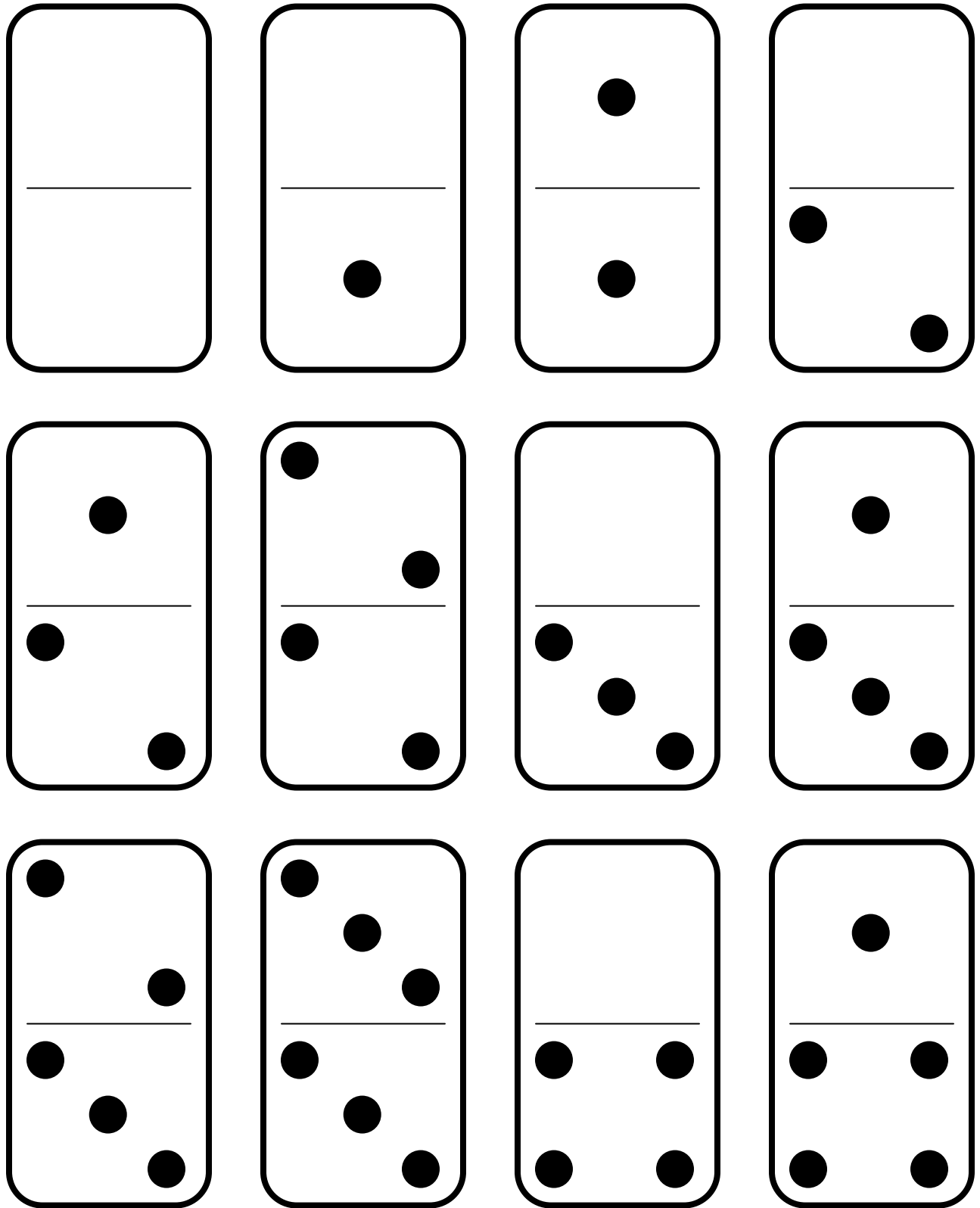

Dominoes (Total of Pips to Ten) (continued)

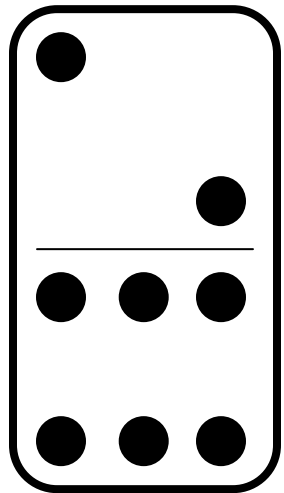
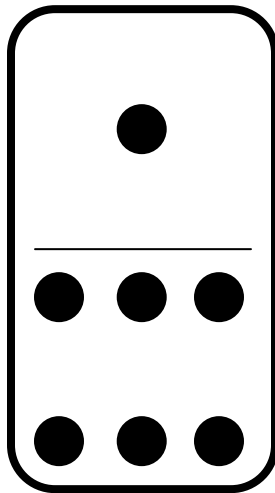
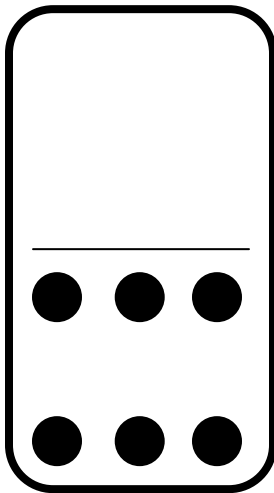
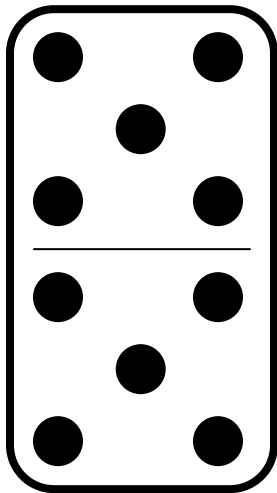
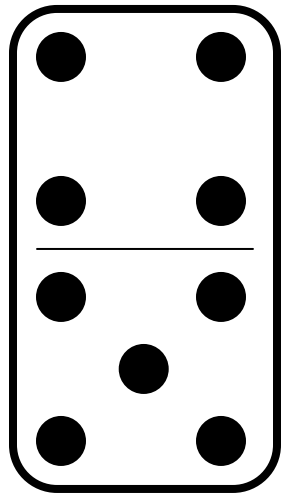
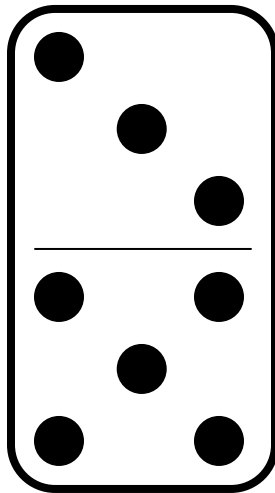
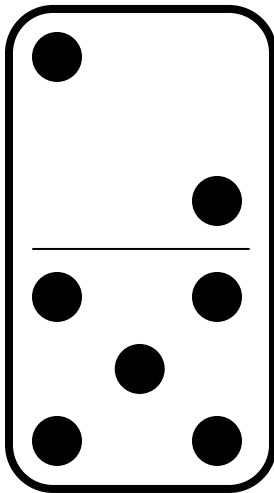
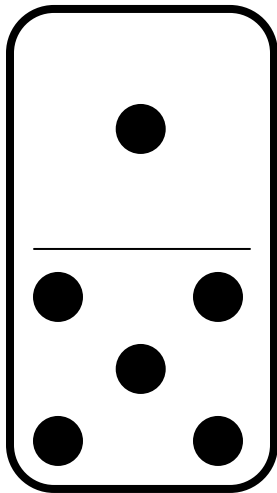
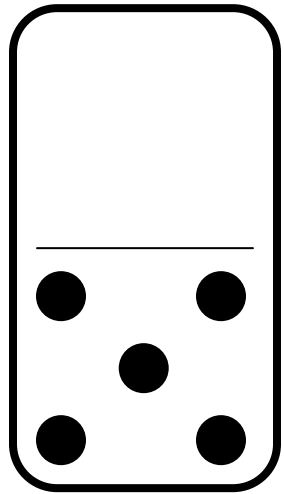
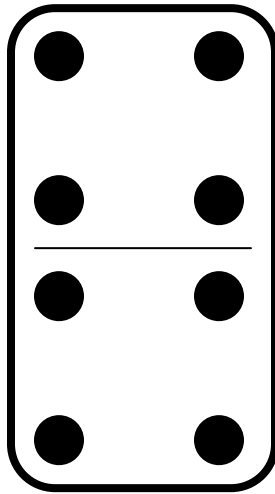
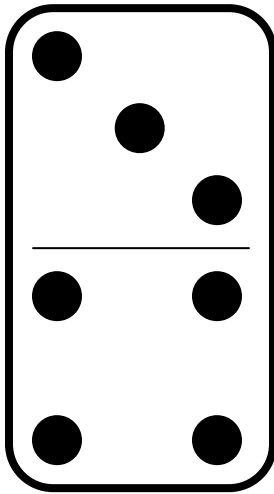
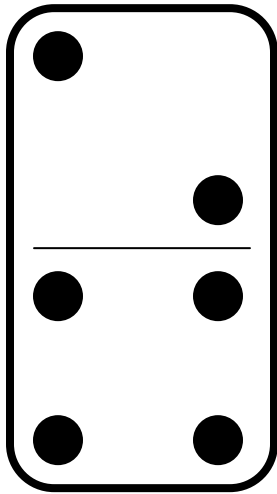

Dominoes (Total of Pips to Ten) (continued)

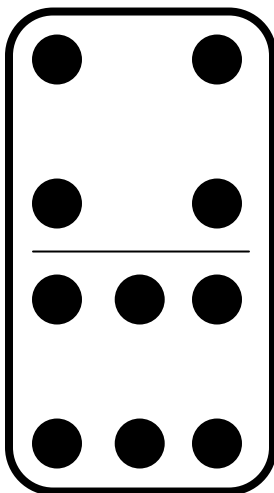
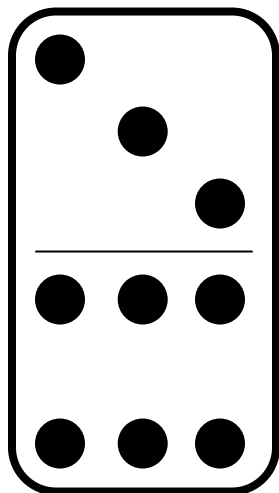

Dot Cards

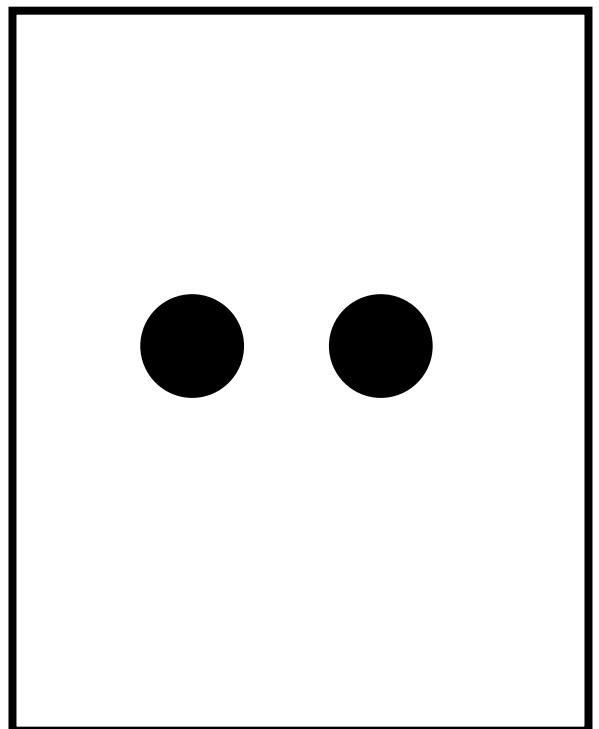
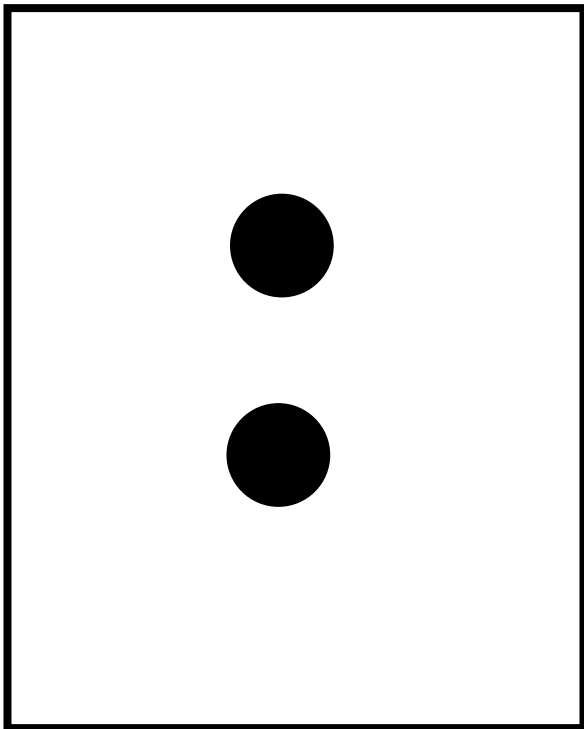
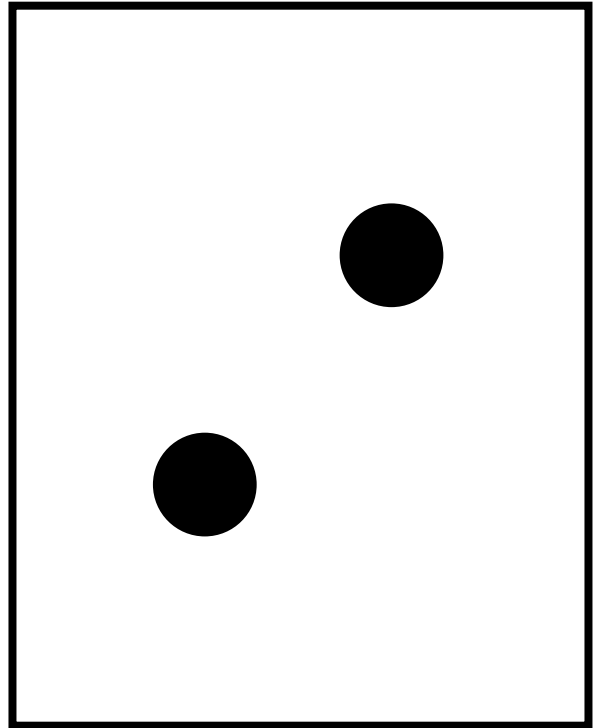
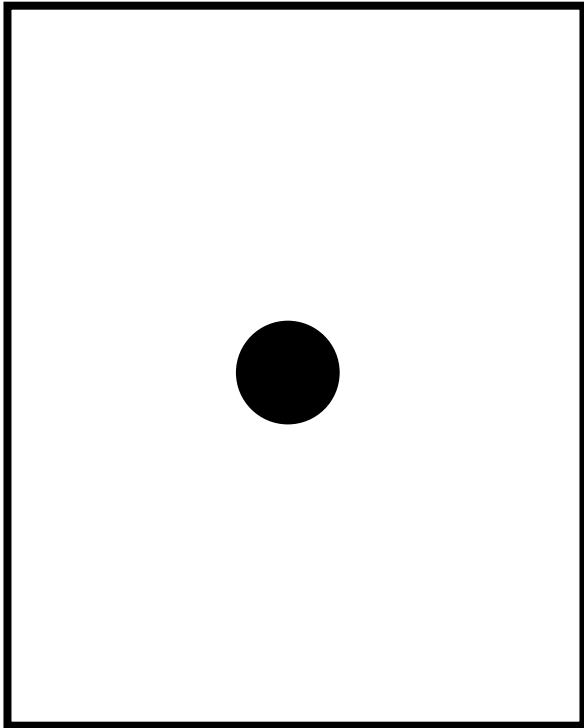

Dot Cards (continued)

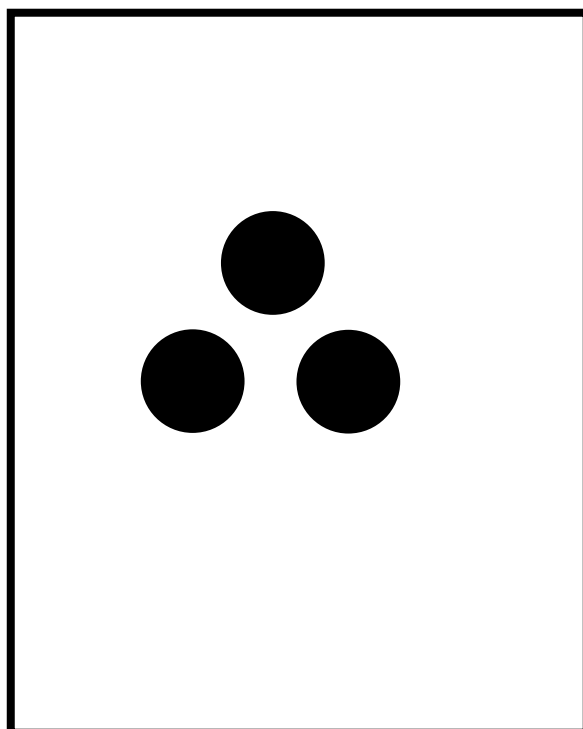
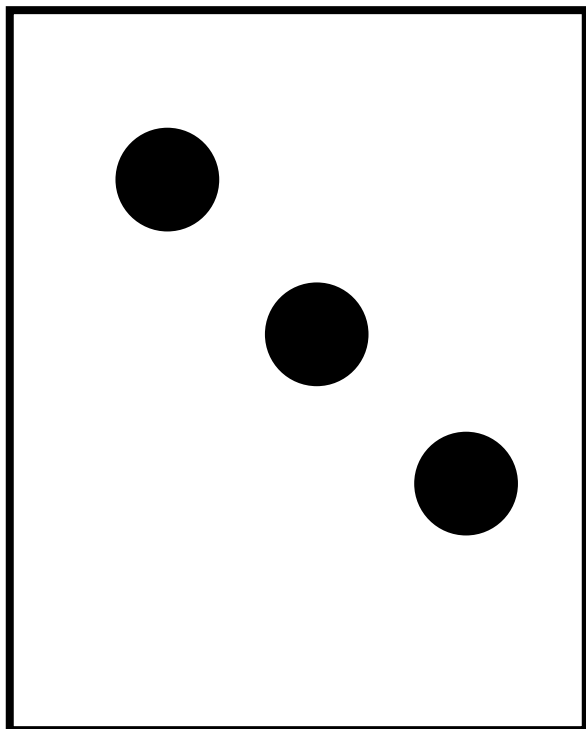
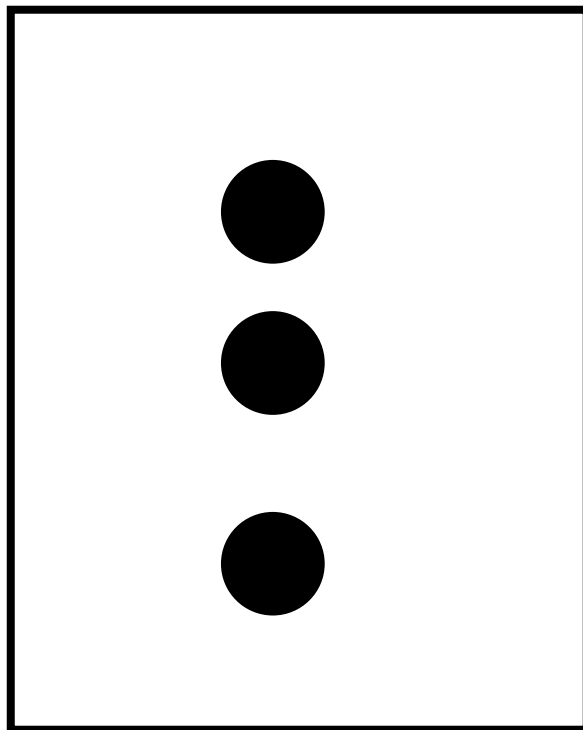
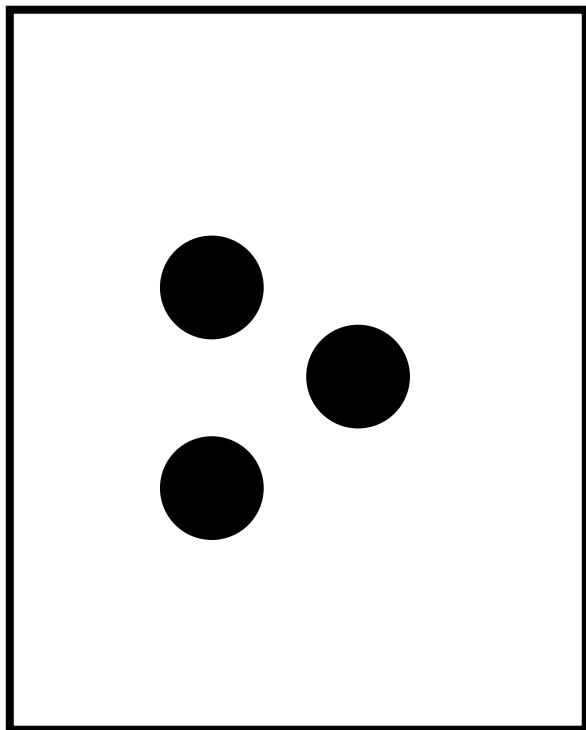

Dot Cards (continued)

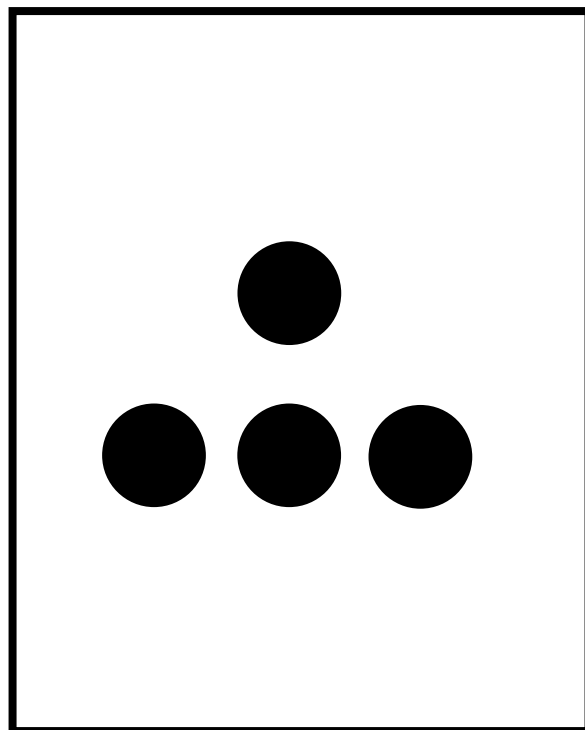
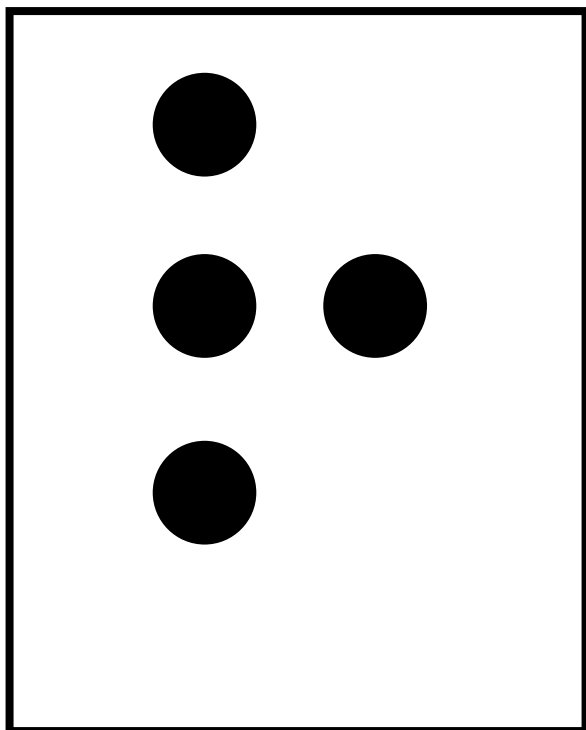
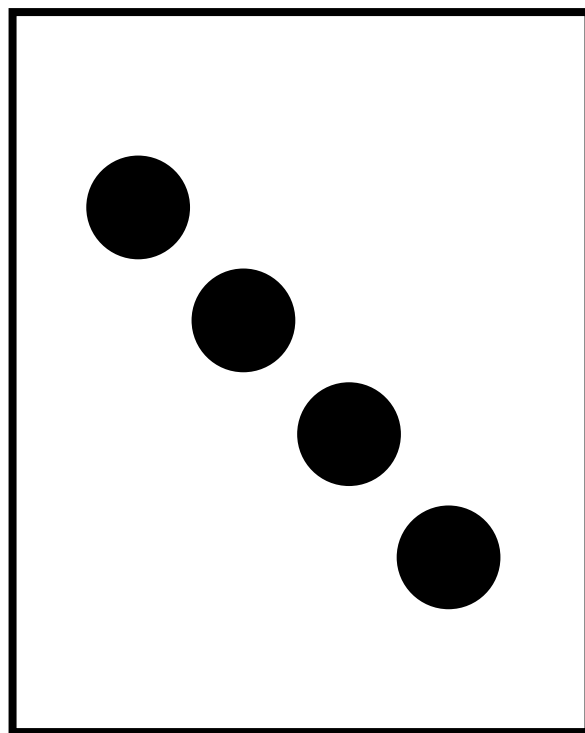
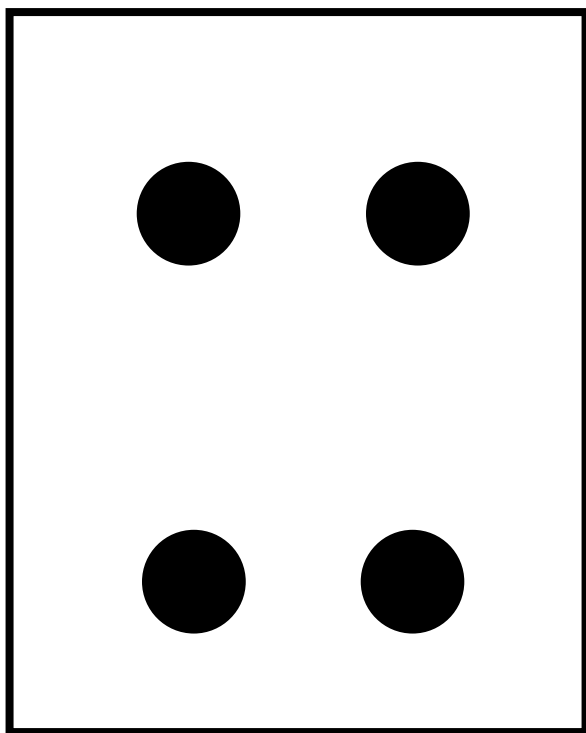

Dot Cards (continued)

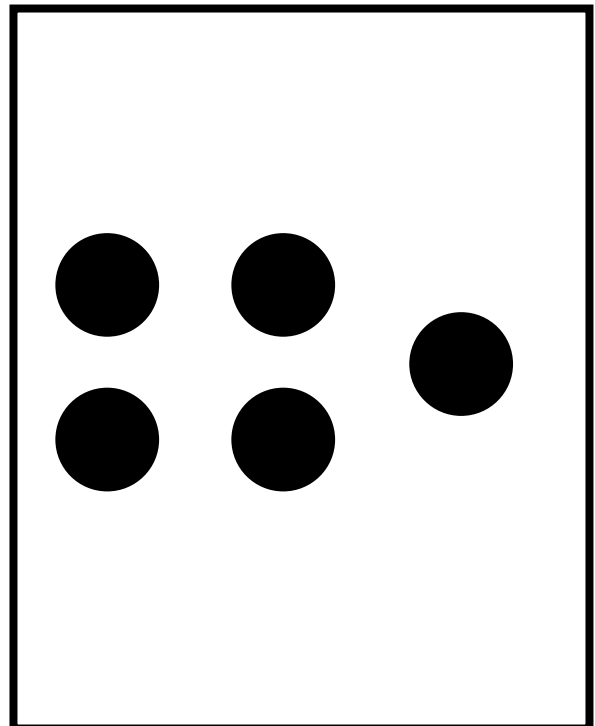
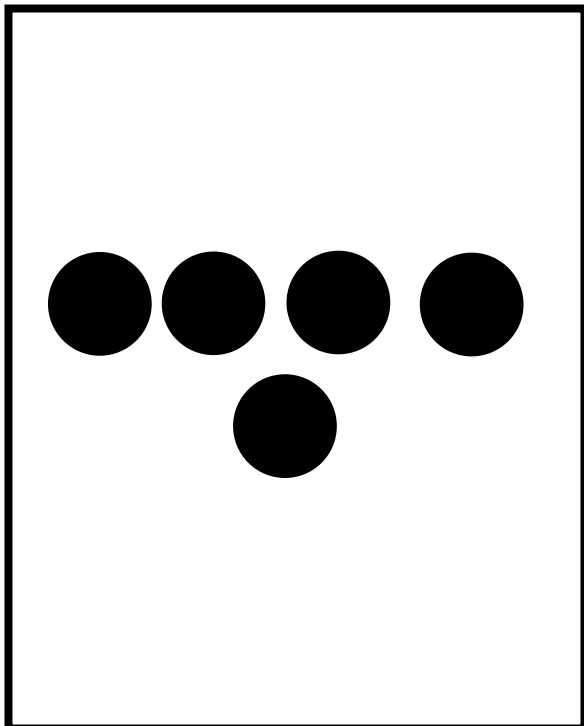
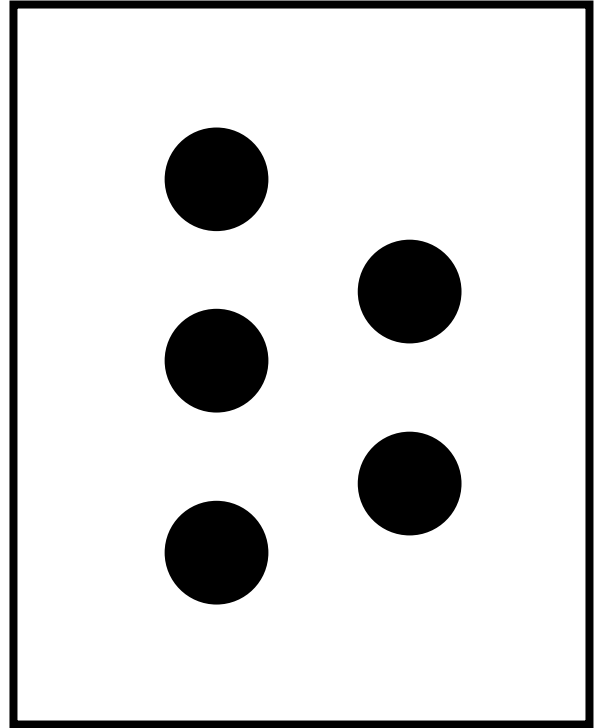
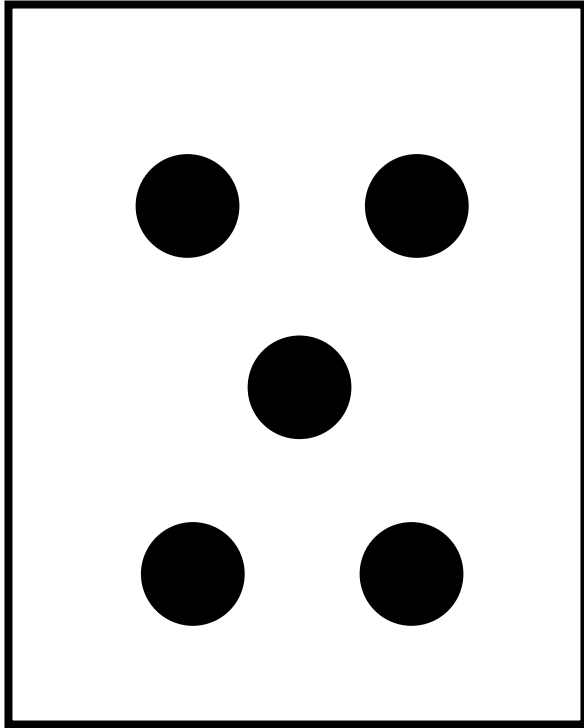

Dot Cards (continued)

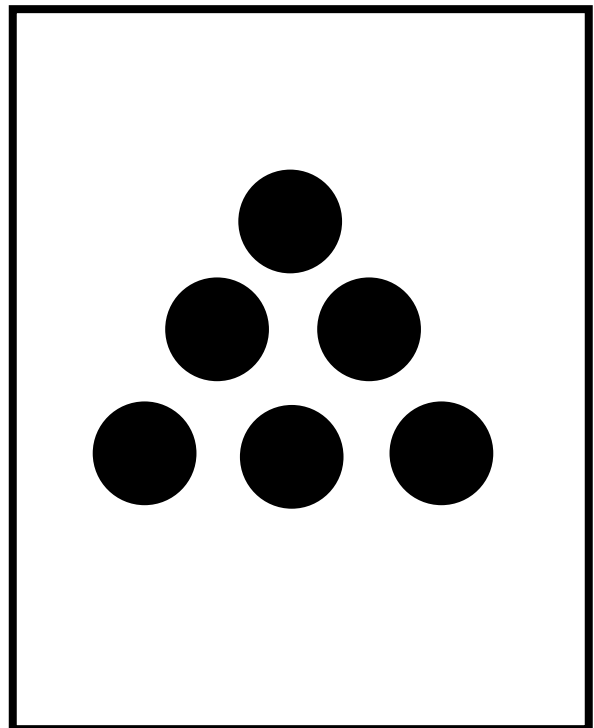
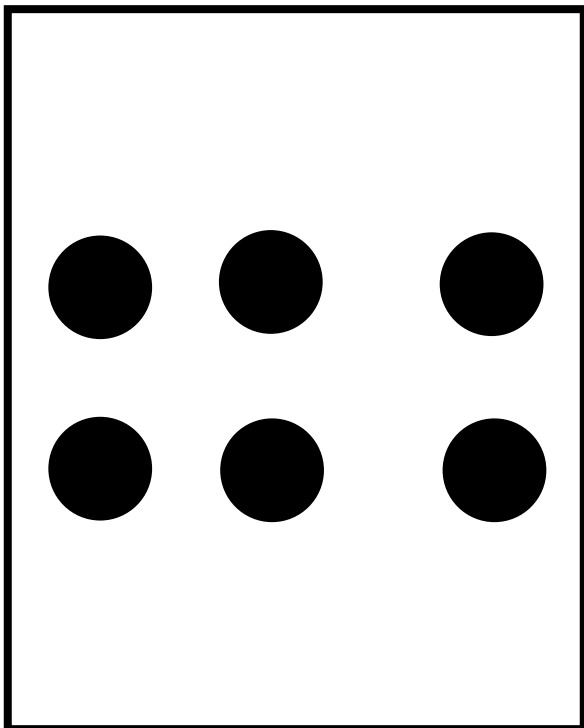
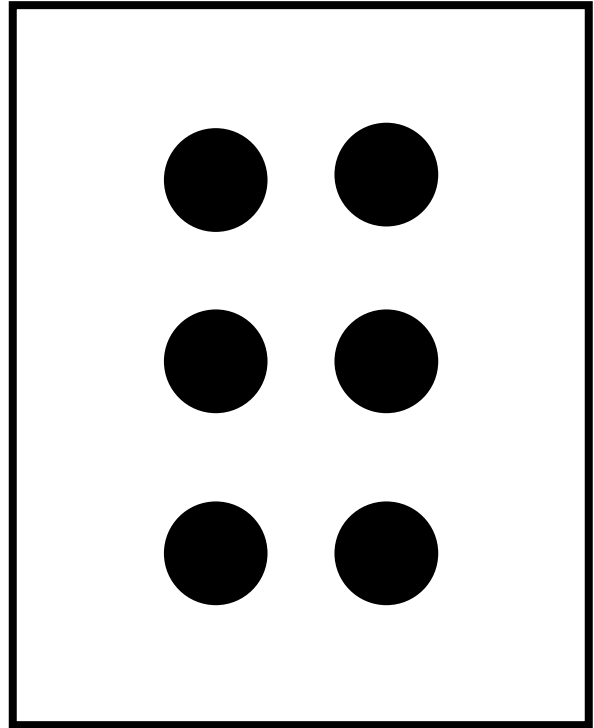
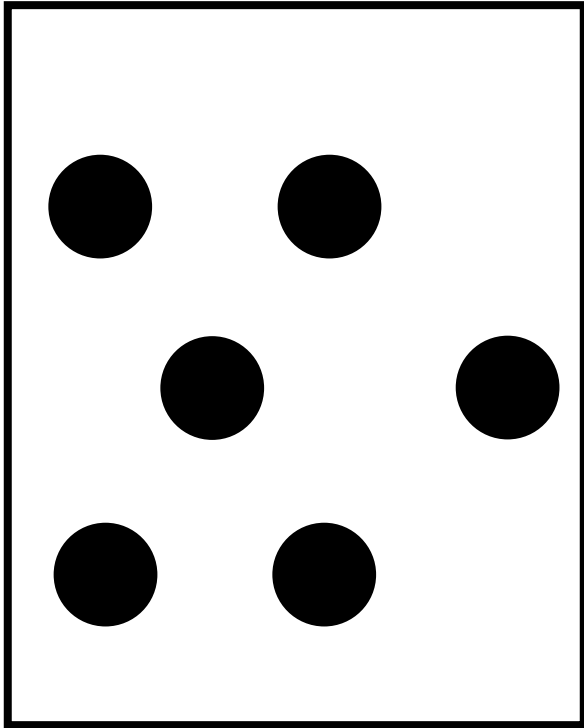

Dot Cards (continued)

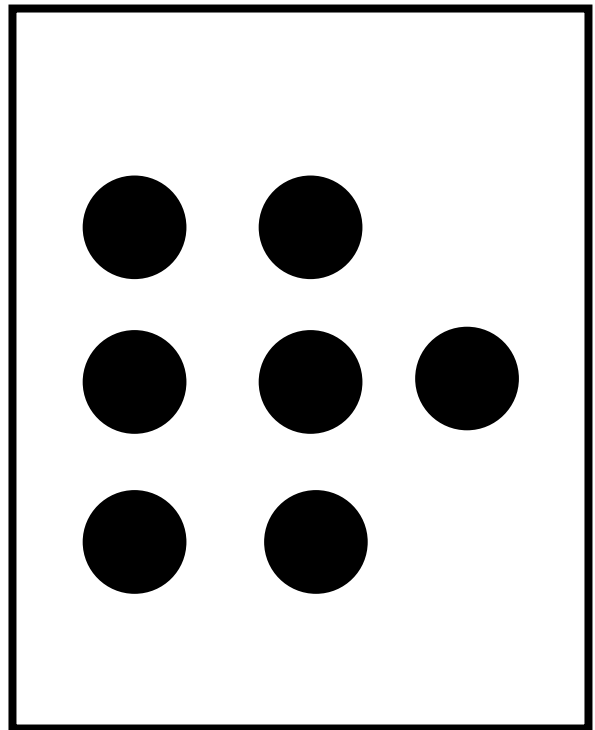
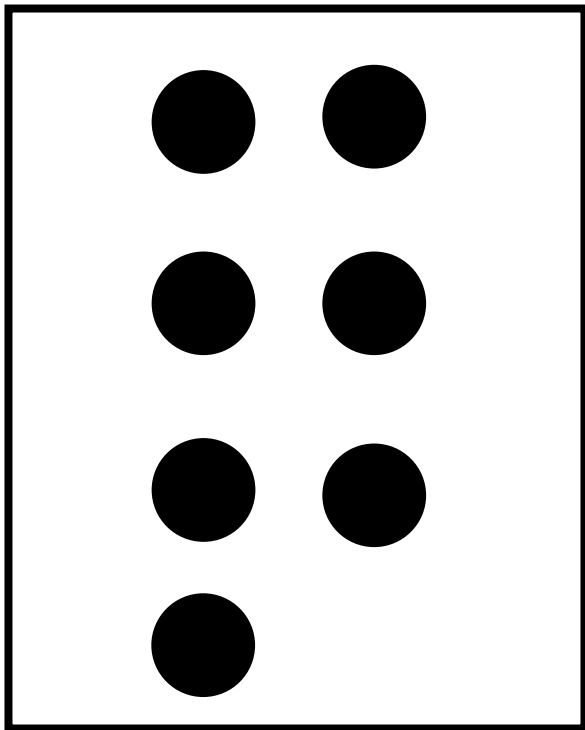
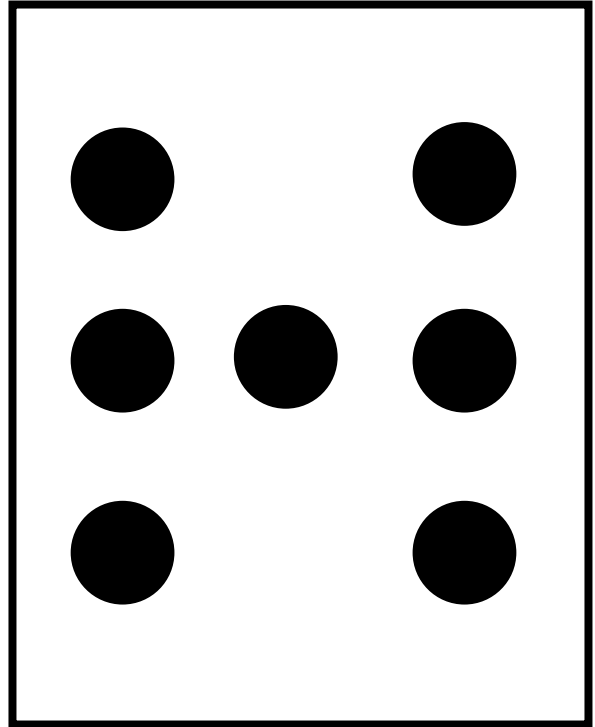
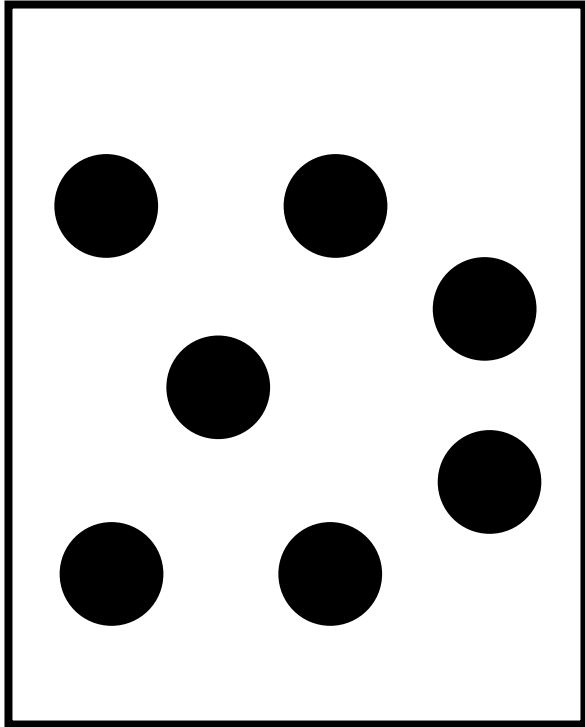

Dot Cards (continued)

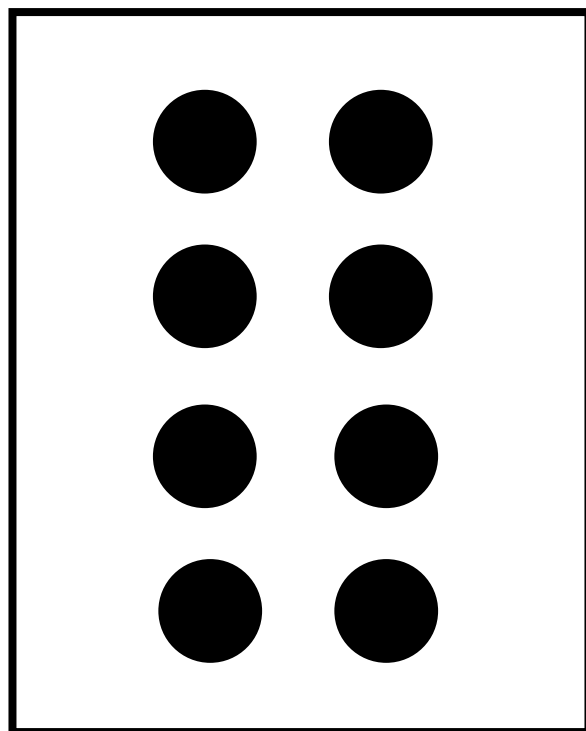
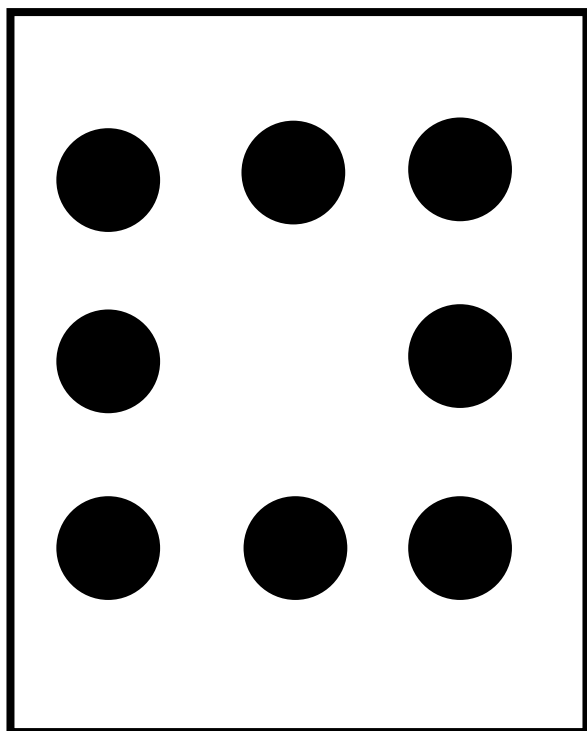
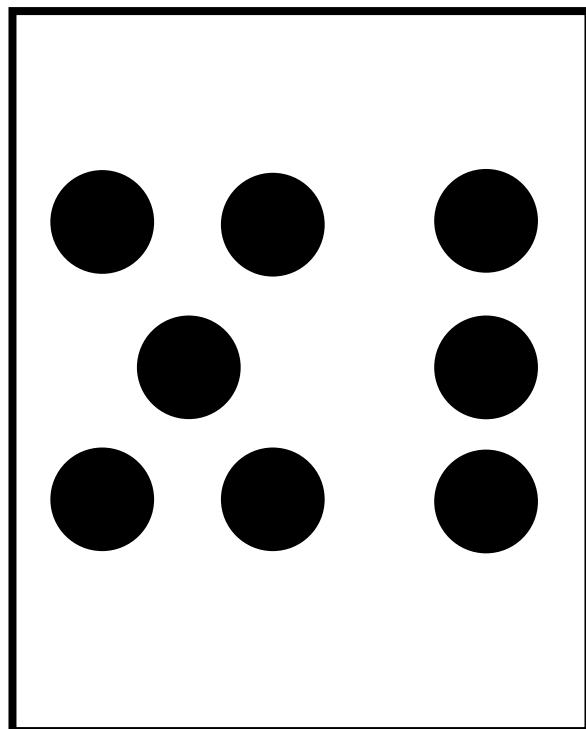
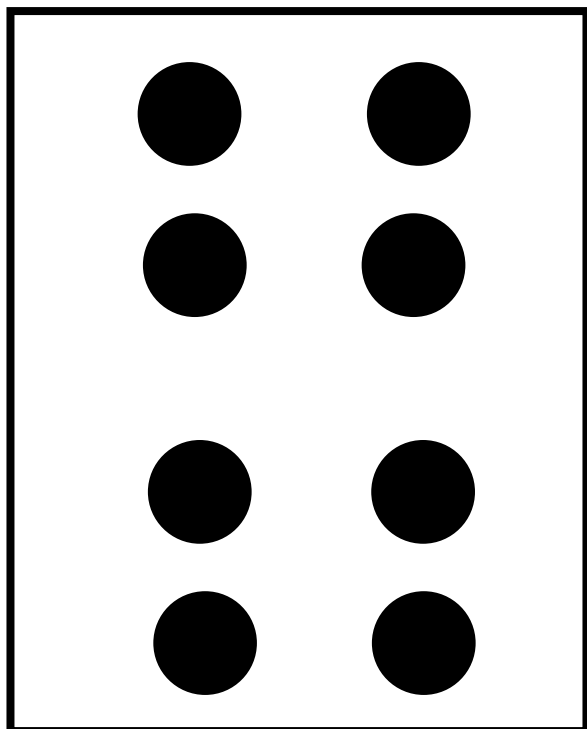

Dot Cards (continued)

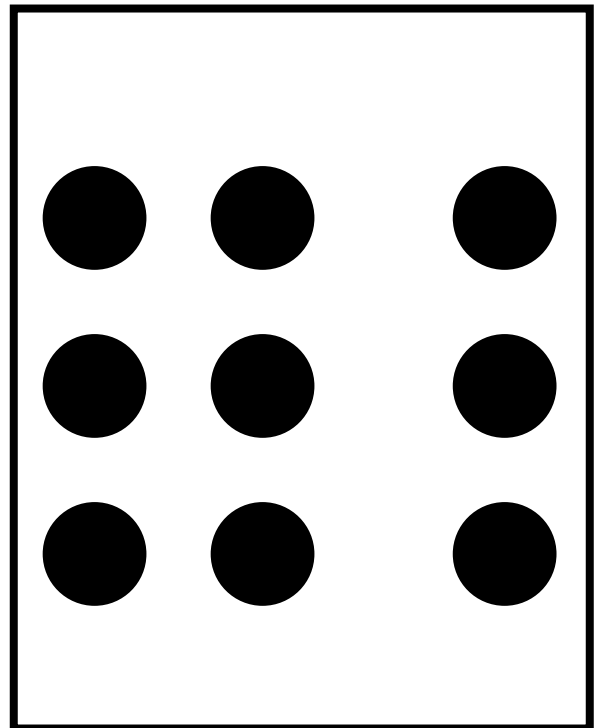
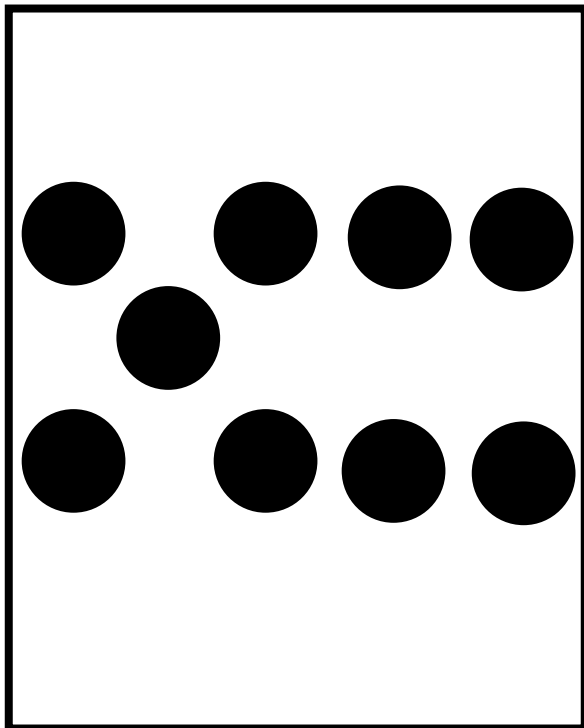
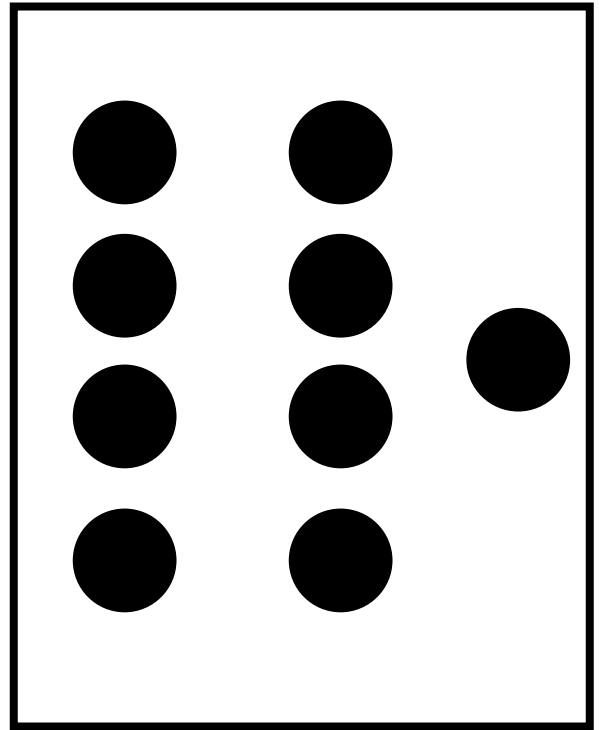
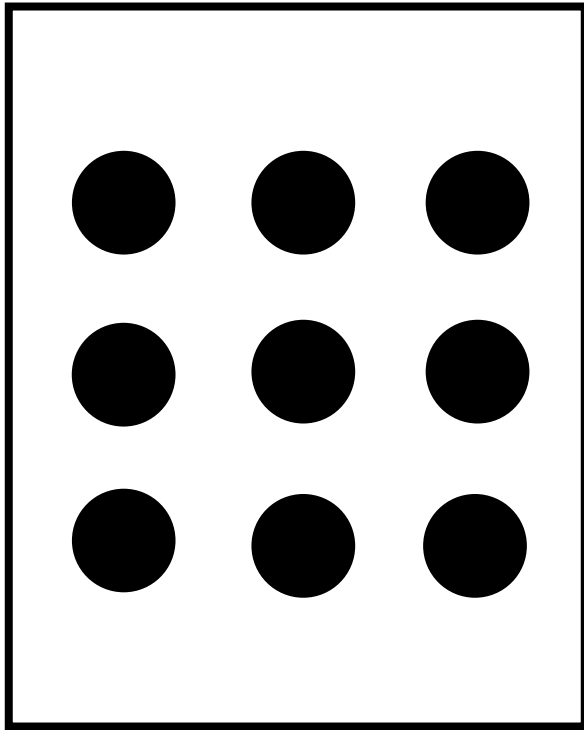

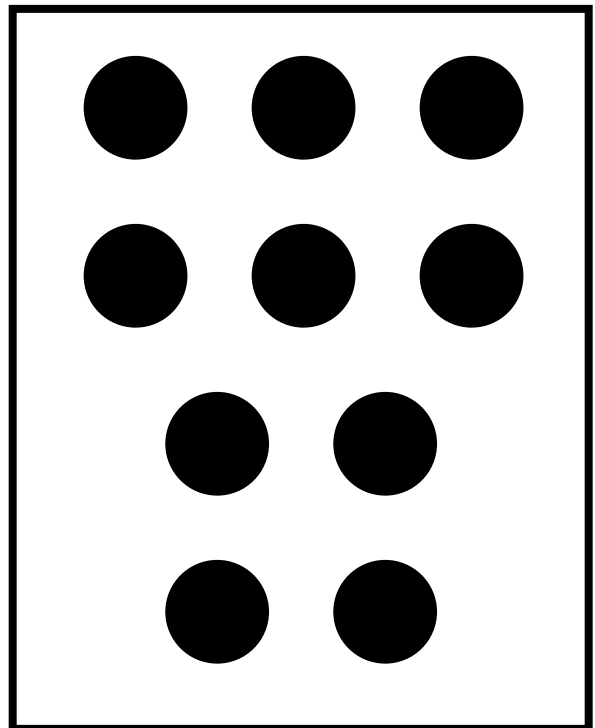
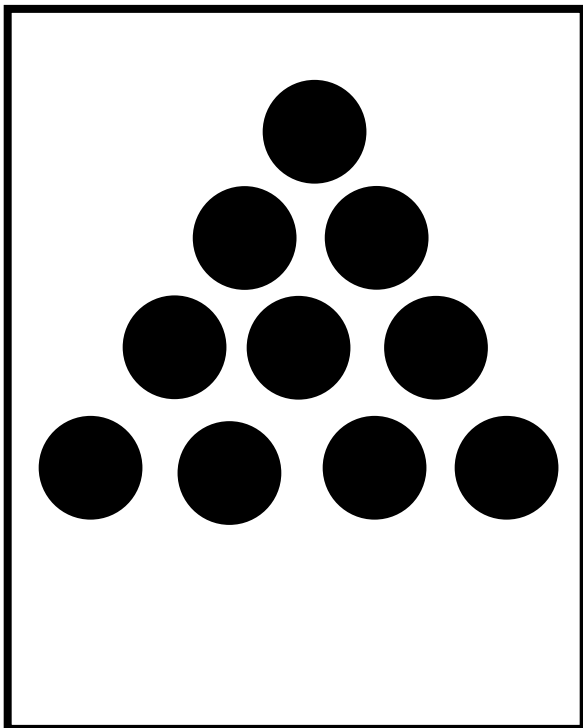
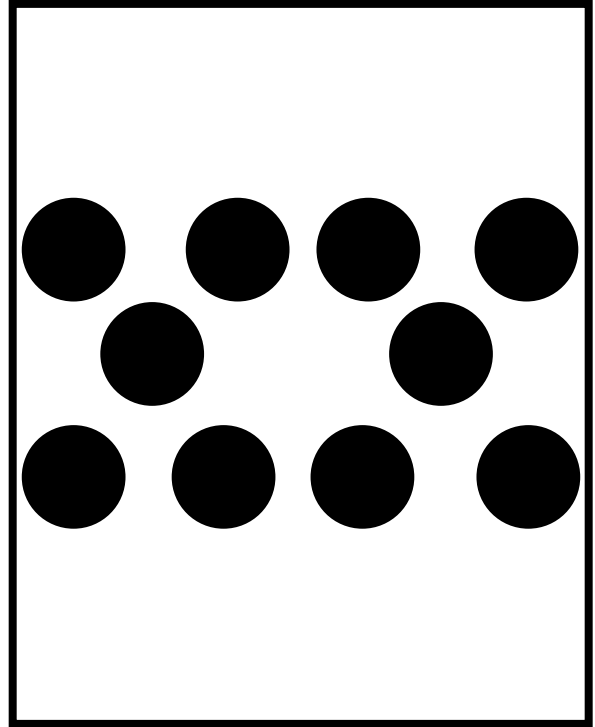
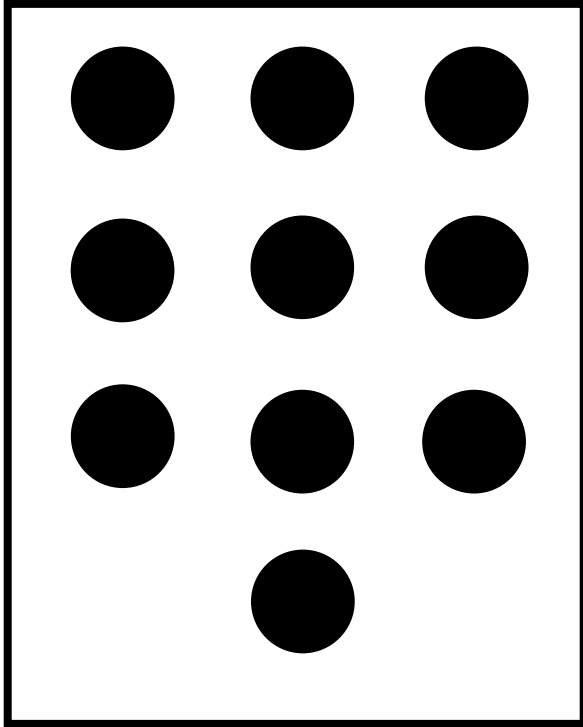

Dot Cards (continued)



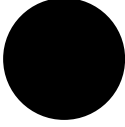

Five Frames

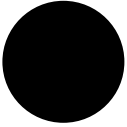

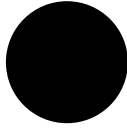
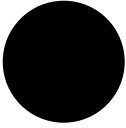
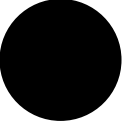





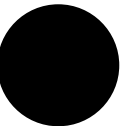
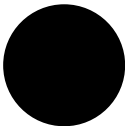
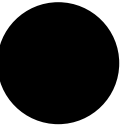
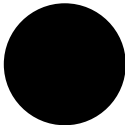
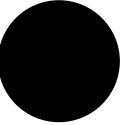
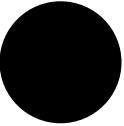

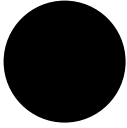
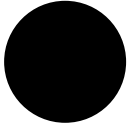
Five Frames (continued)

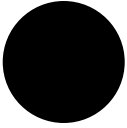
Five Frames (continued)

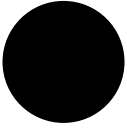
Five Frames (continued)

Five Frames (continued)

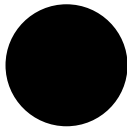
●		●	
●		●	●
●	●	●	●
●	●	●	●
●	●	●	●

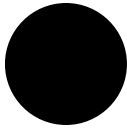
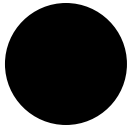
Five Frames

●	●		
●	●		
●	●		
●	●		
●	●		

Large Ten Frames

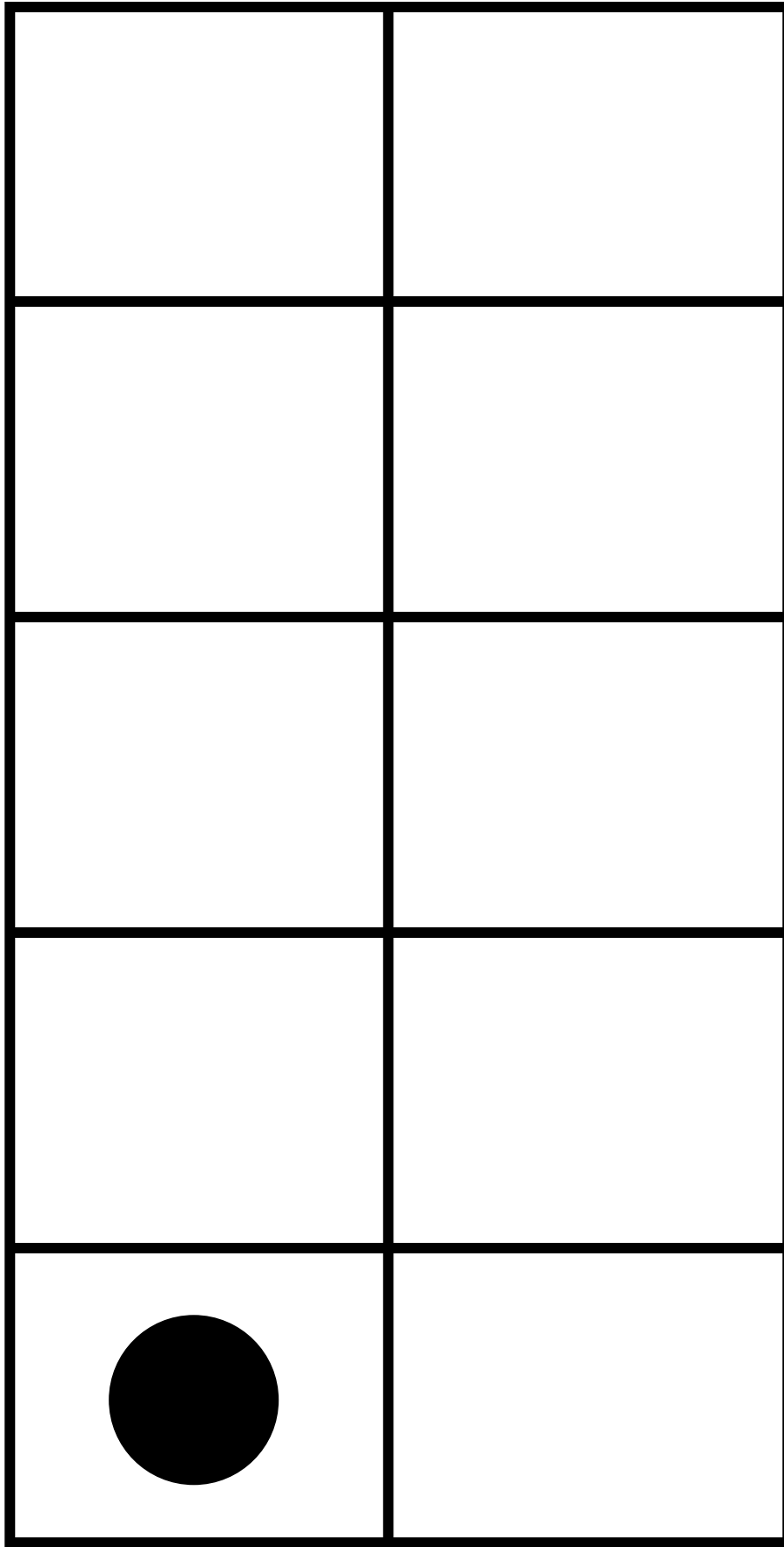

Large Ten Frames (continued)

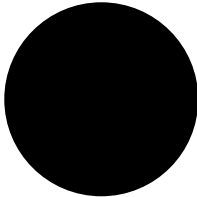
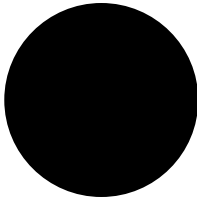
Large Ten Frames (continued)

Large Ten Frames (continued)

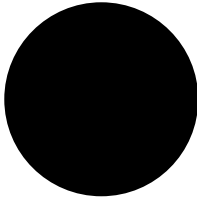
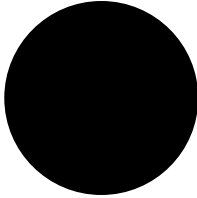
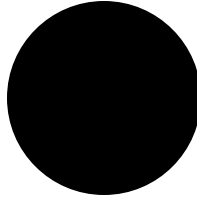
Large Ten Frames (continued)

									
---	--	---	--	--	--	---	--	---	--

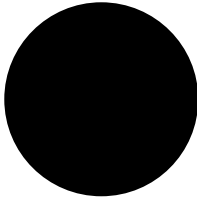
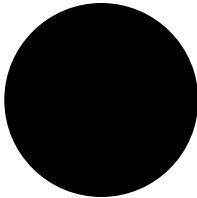
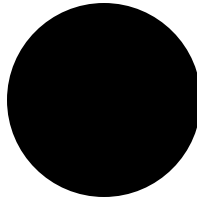
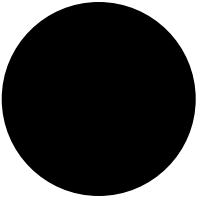
Large Ten Frames (continued)

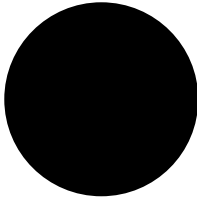
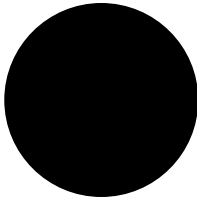
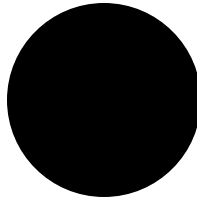
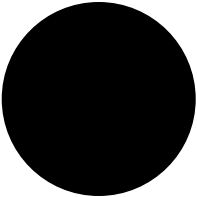
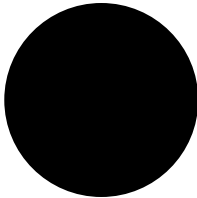

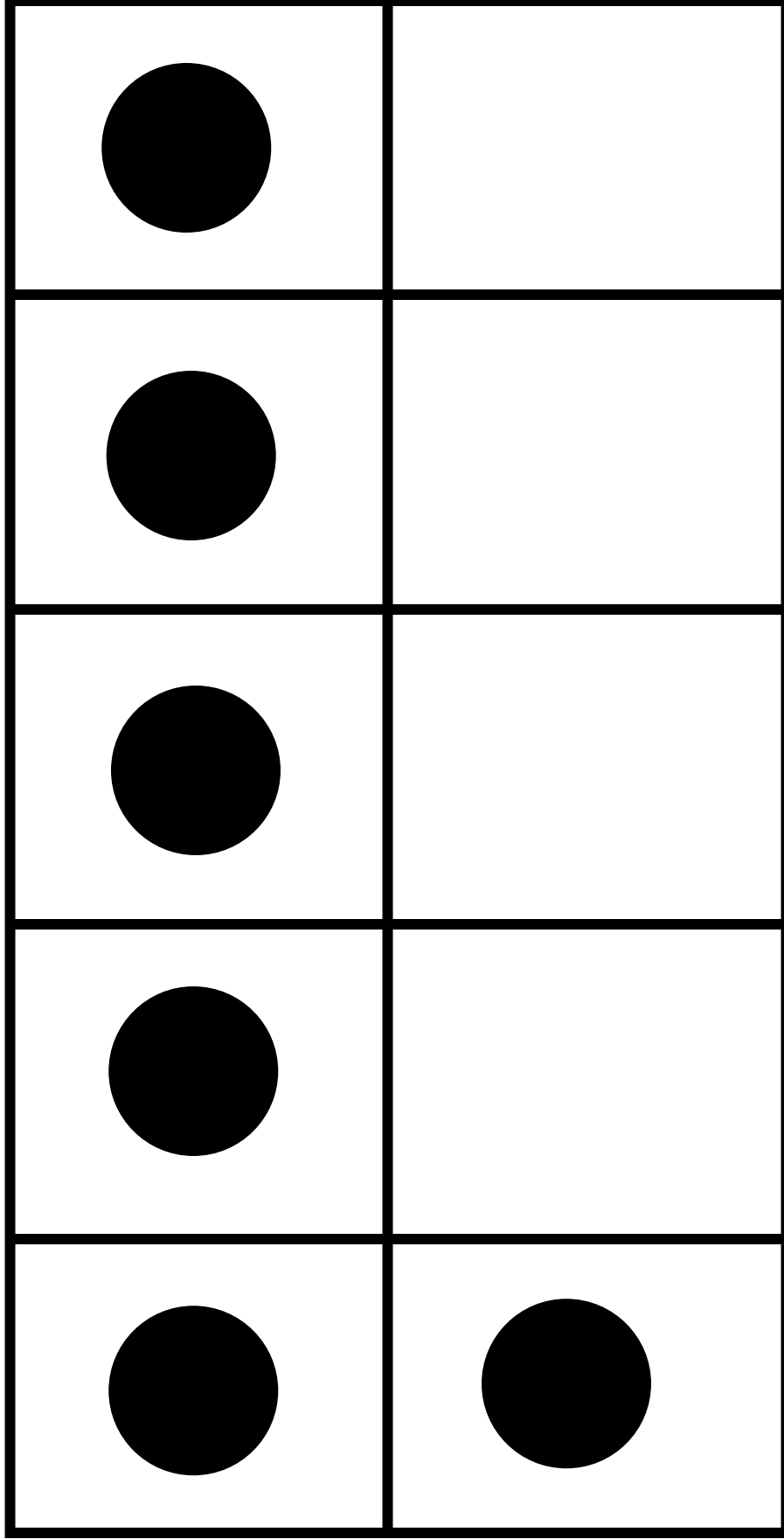
Large Ten Frames (continued)

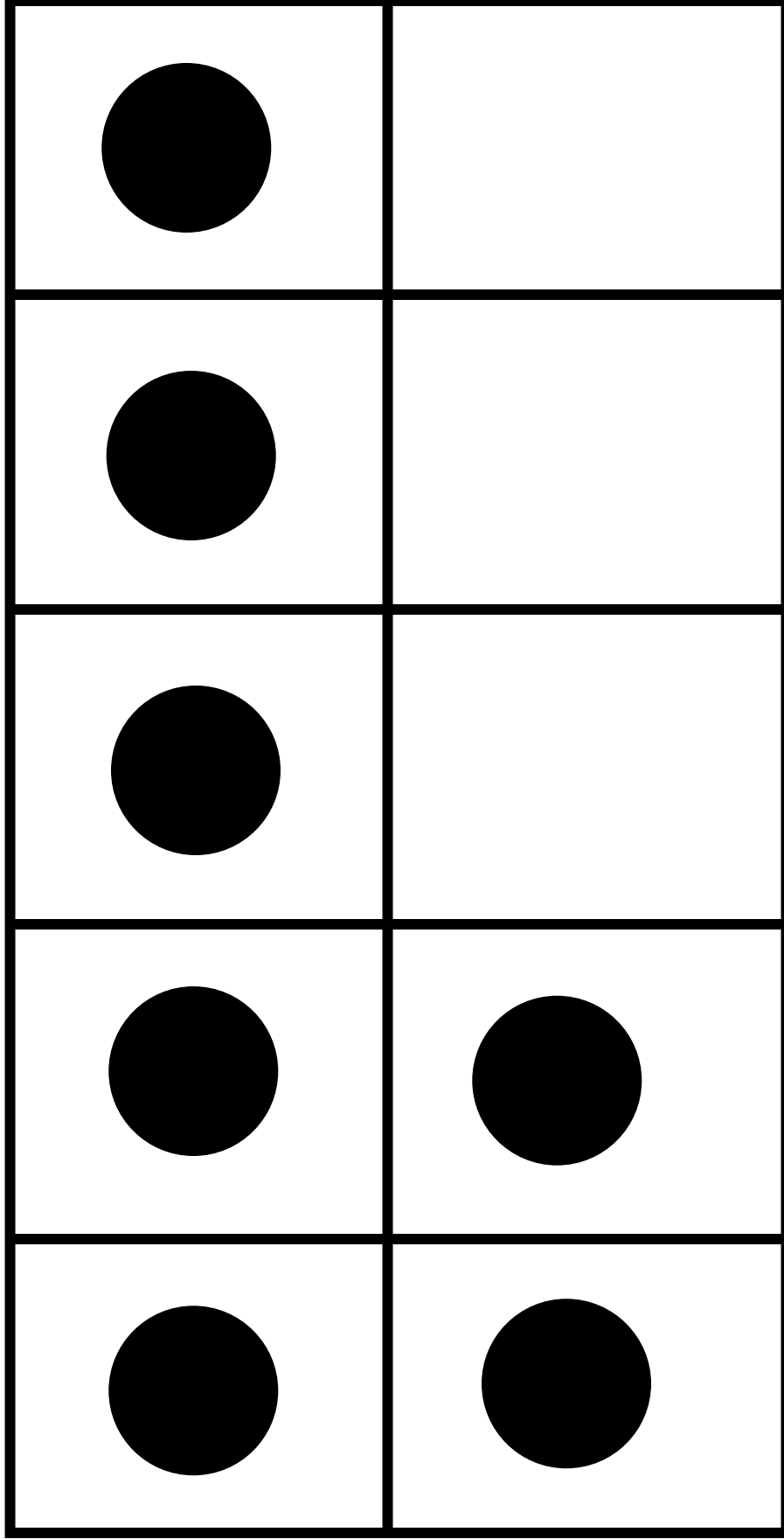

Large Ten Frames (continued)

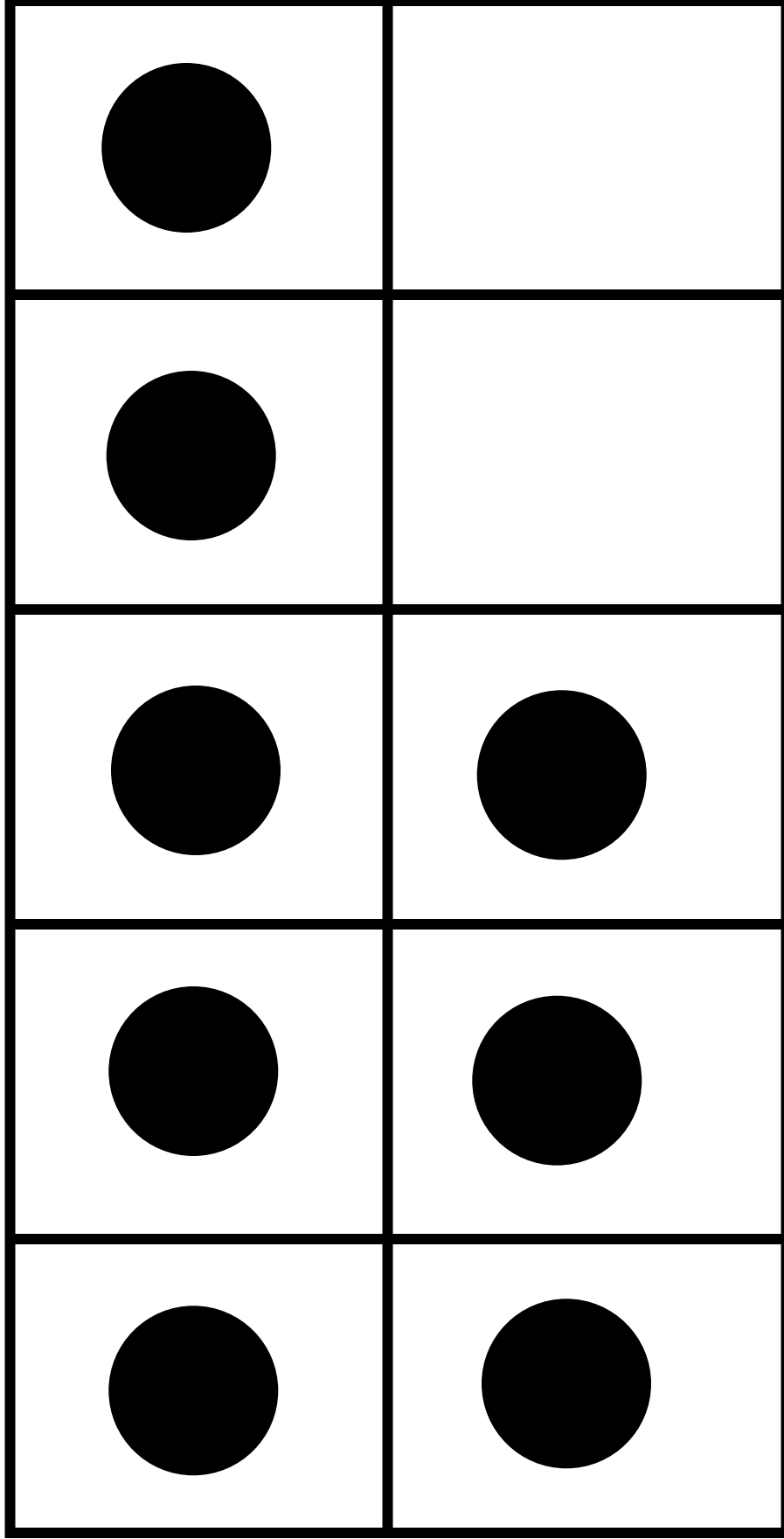

Large Ten Frames (continued)

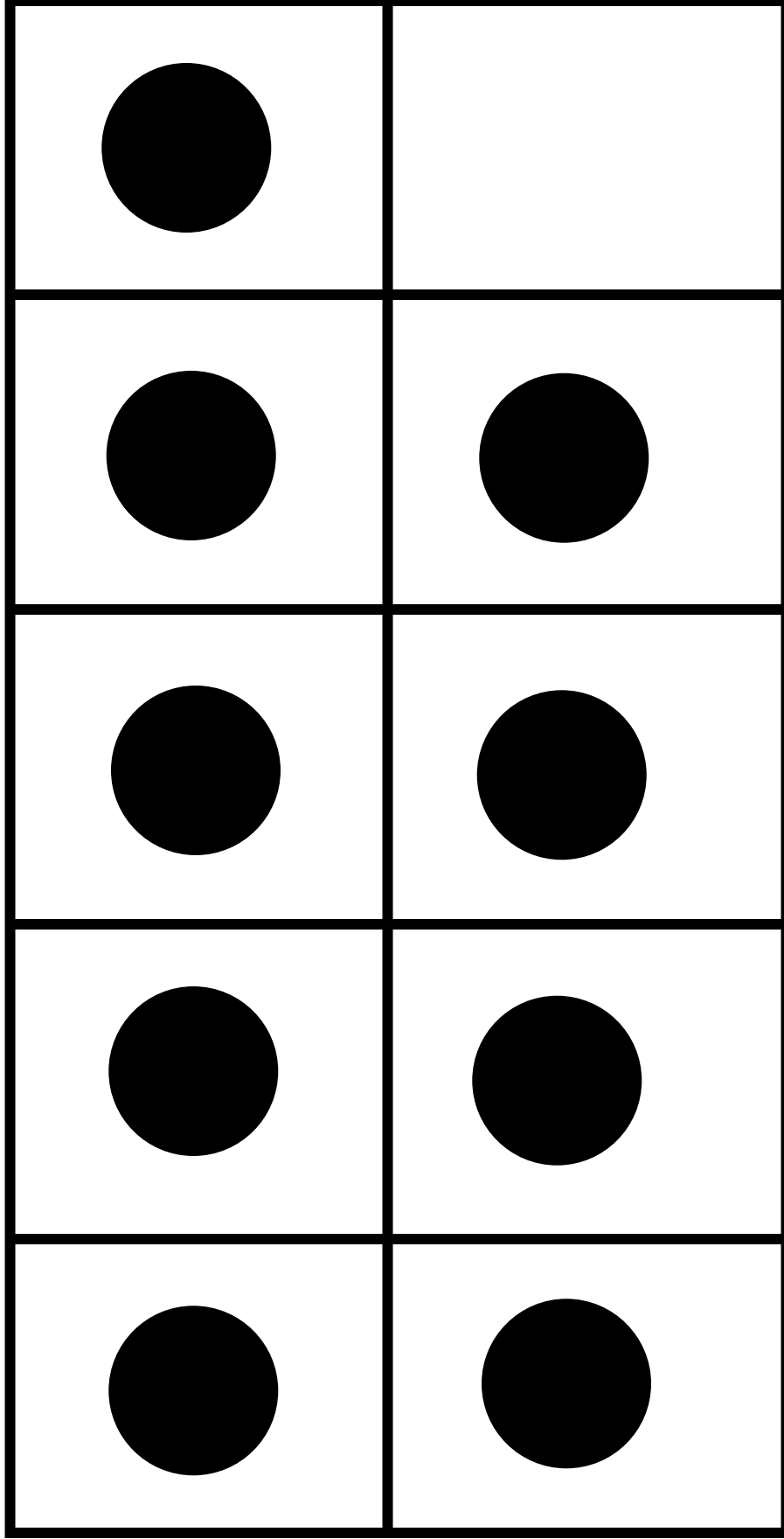

Large Ten Frames (continued)

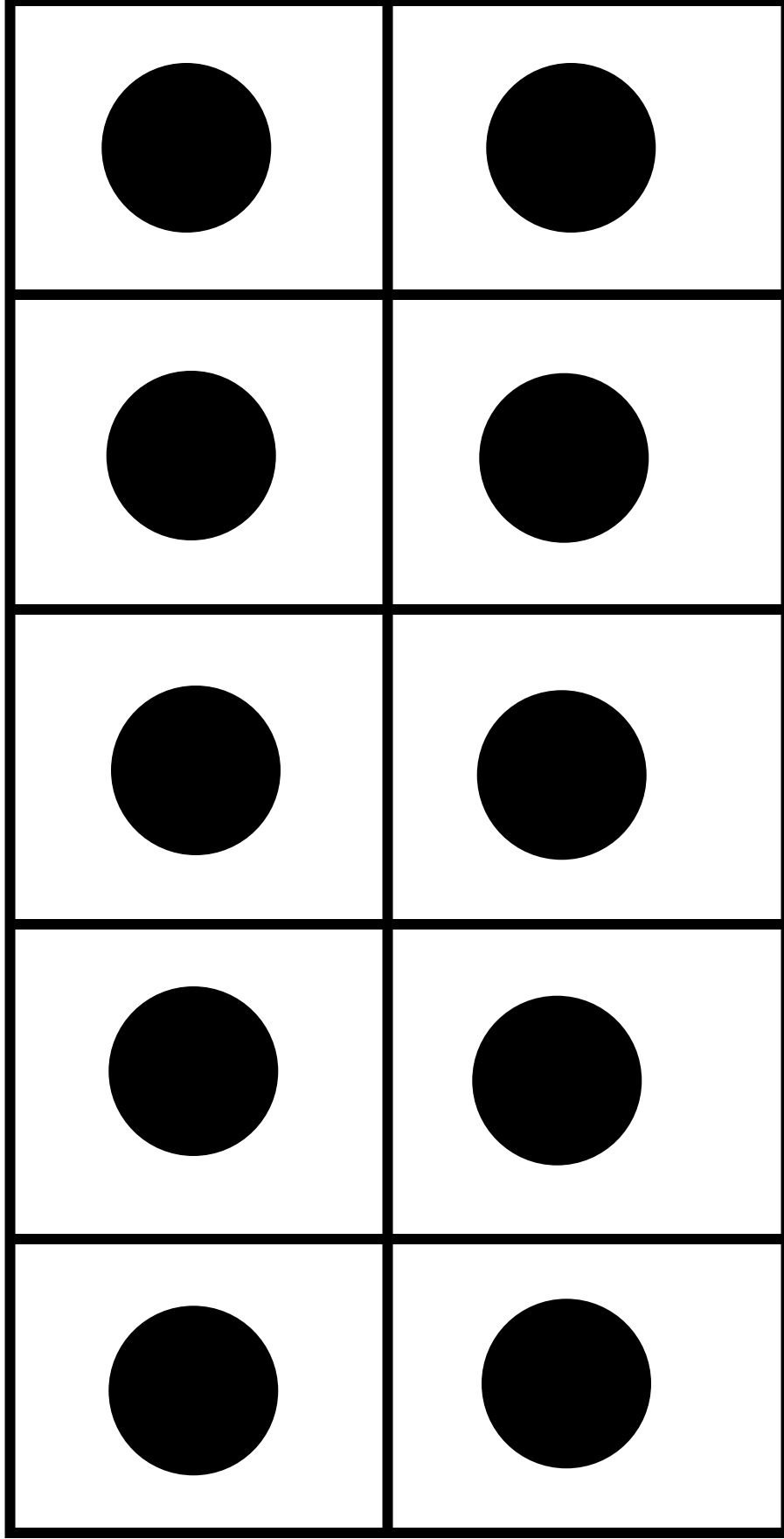

Large Ten Frames (continued)

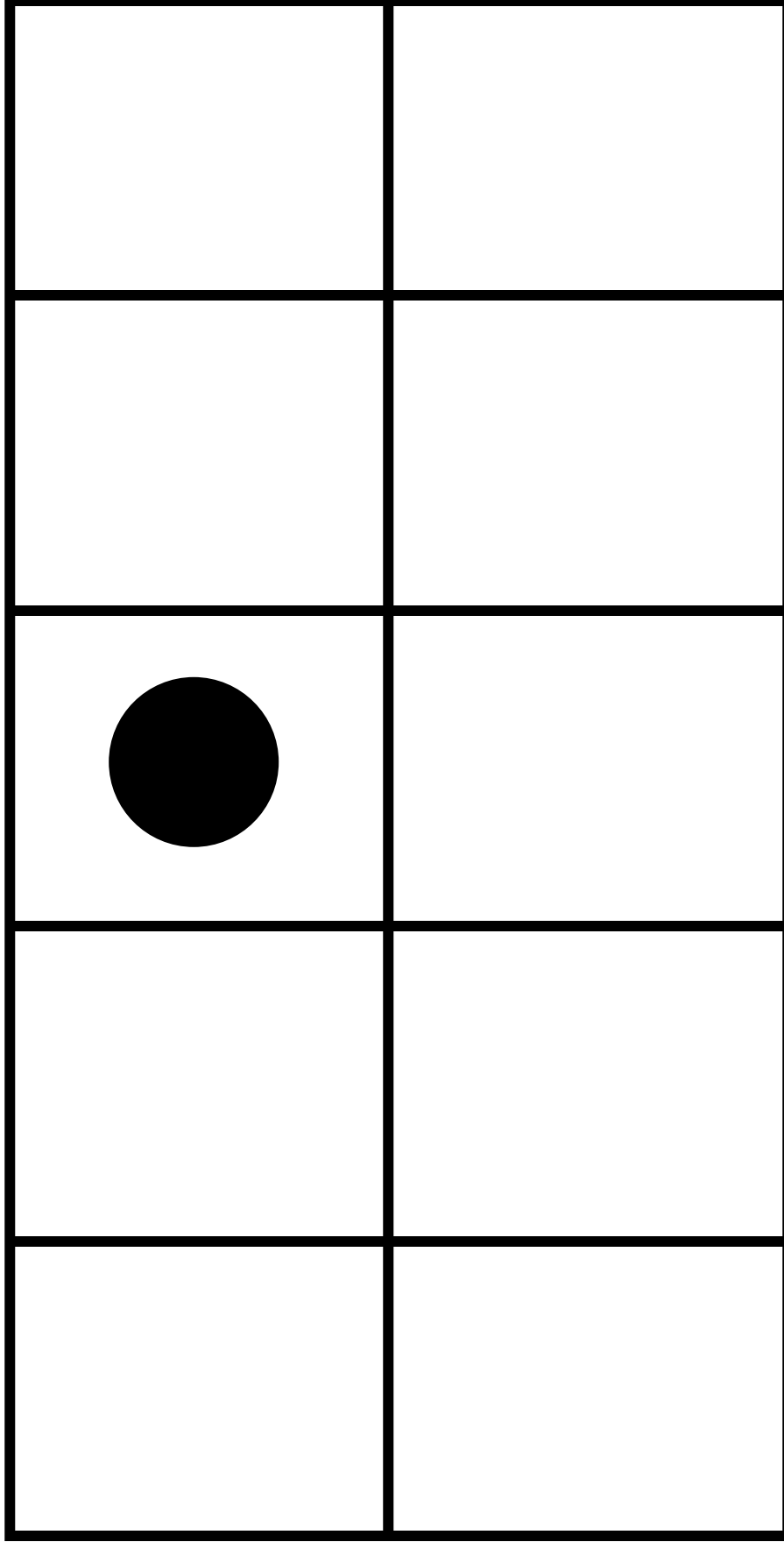

Large Ten Frames (continued)

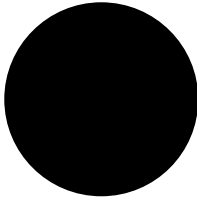
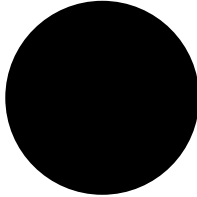
Large Ten Frames (continued)

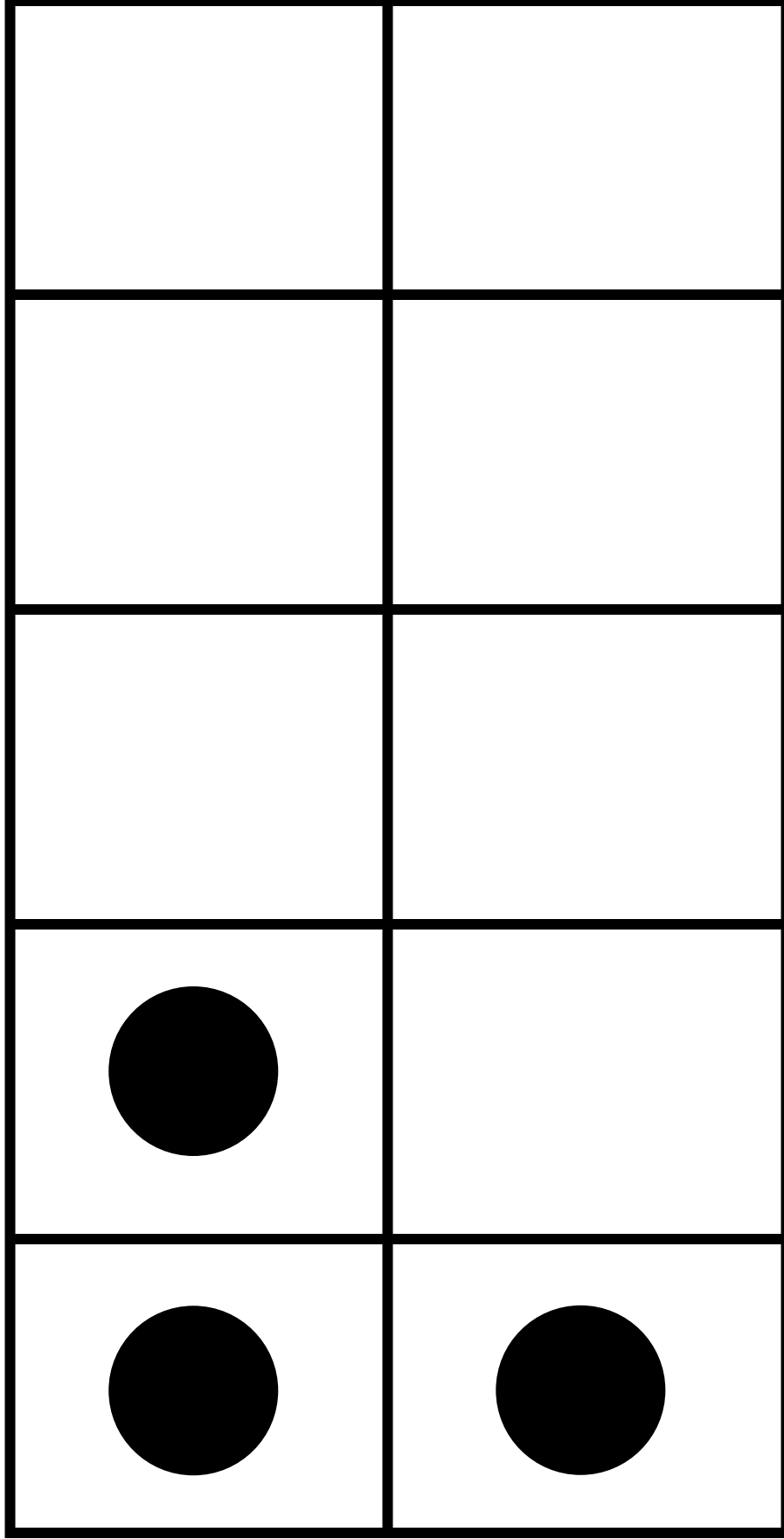

Large Ten Frames (continued)

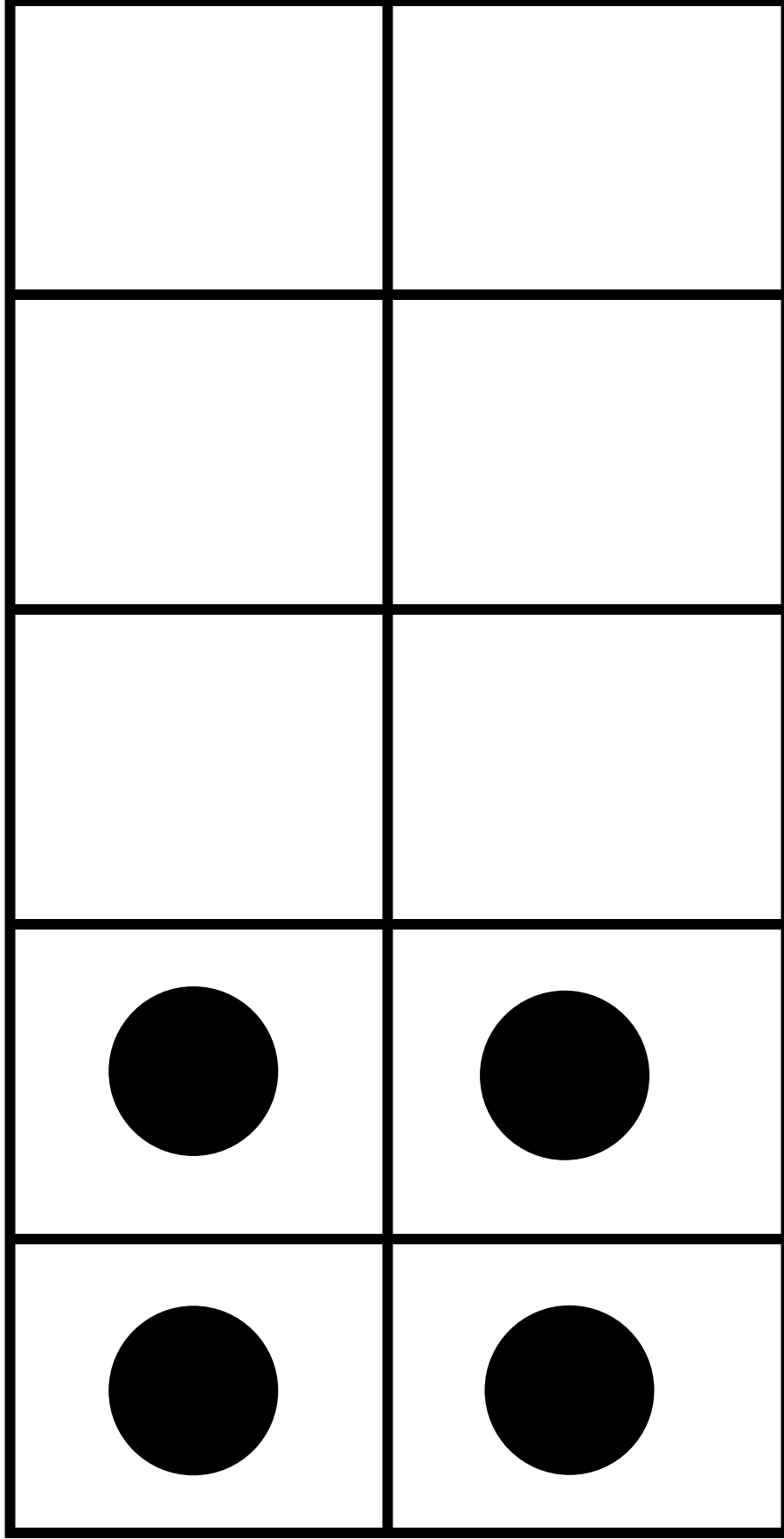

Large Ten Frames (continued)

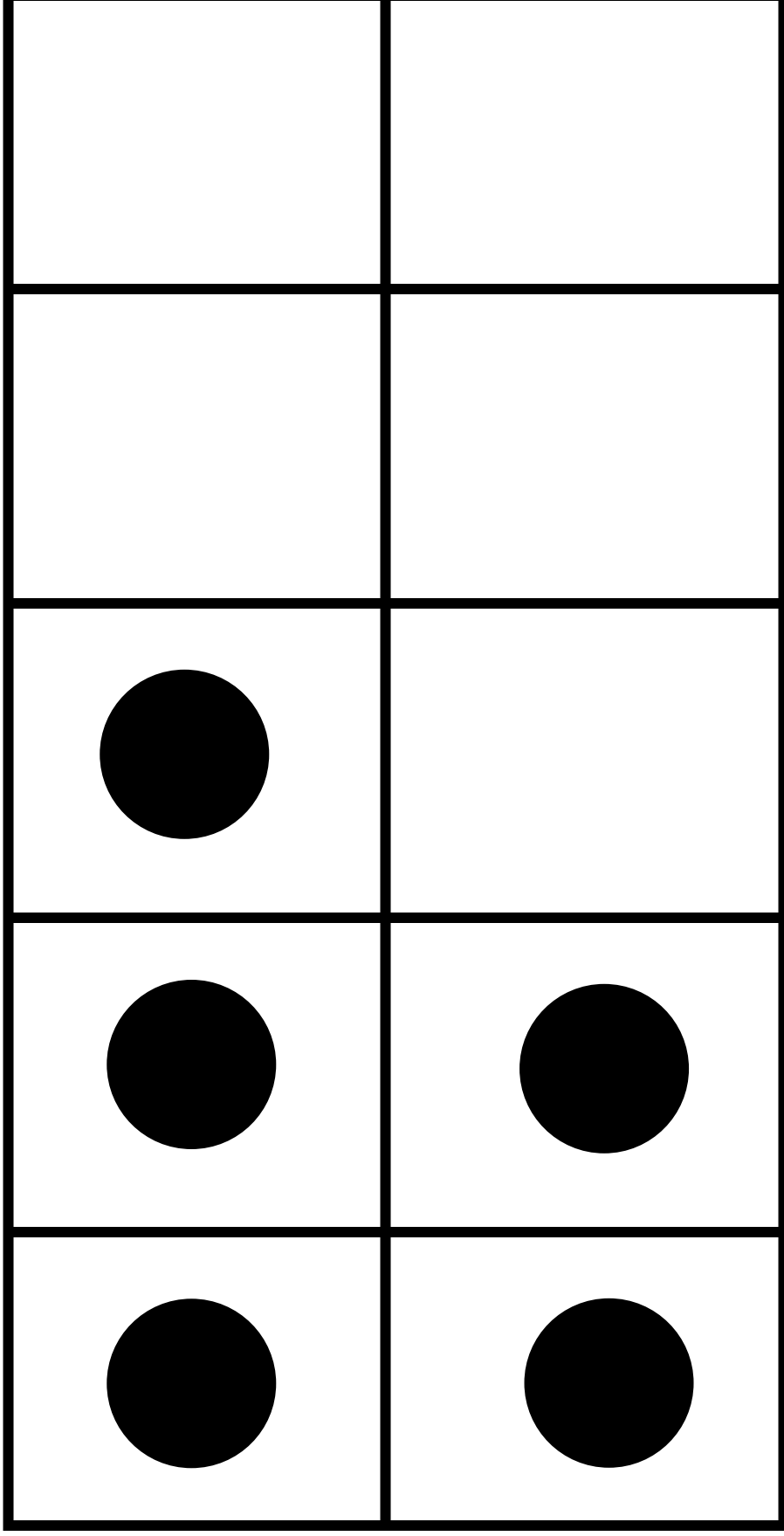

Large Ten Frames (continued)

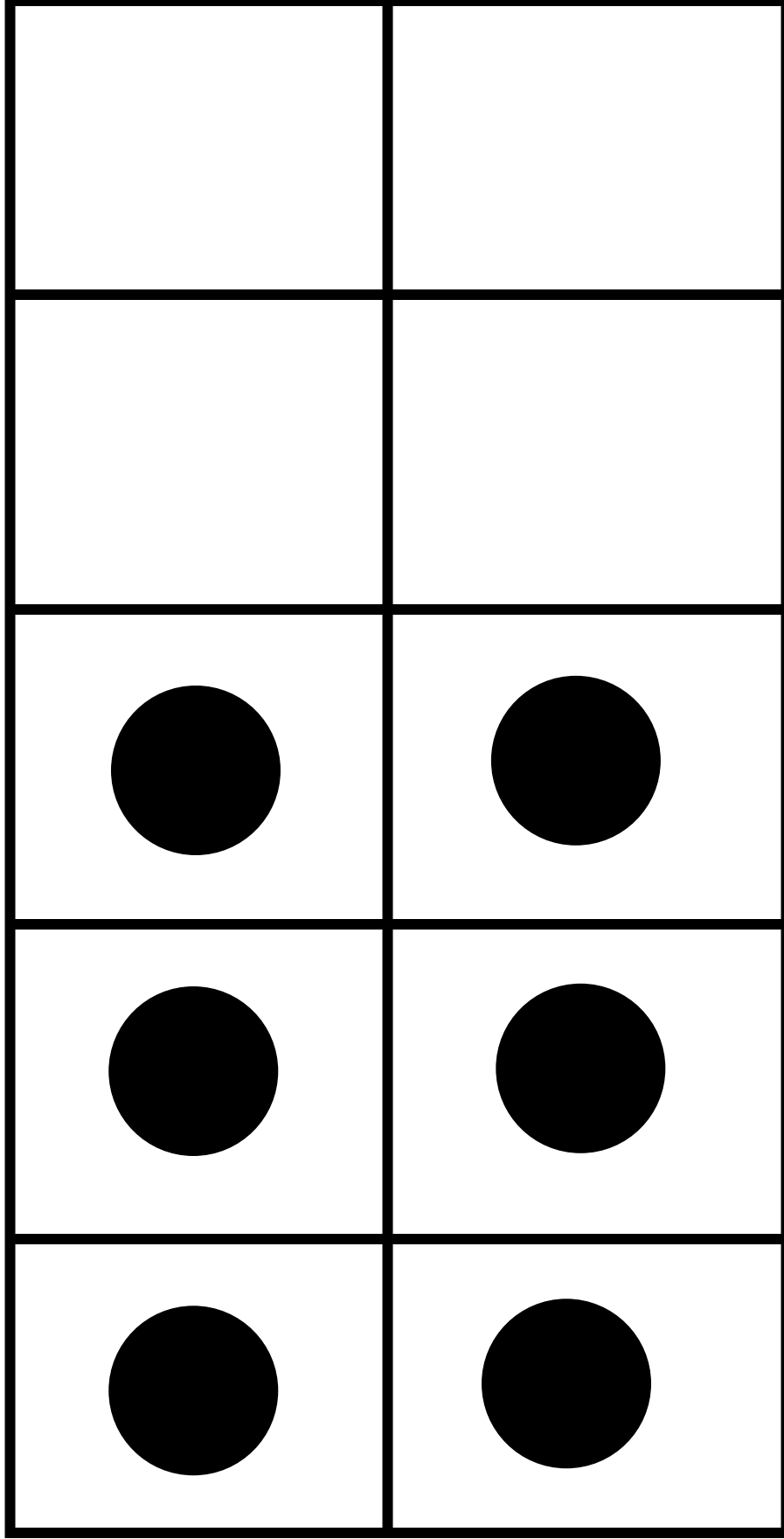

Large Ten Frames (continued)

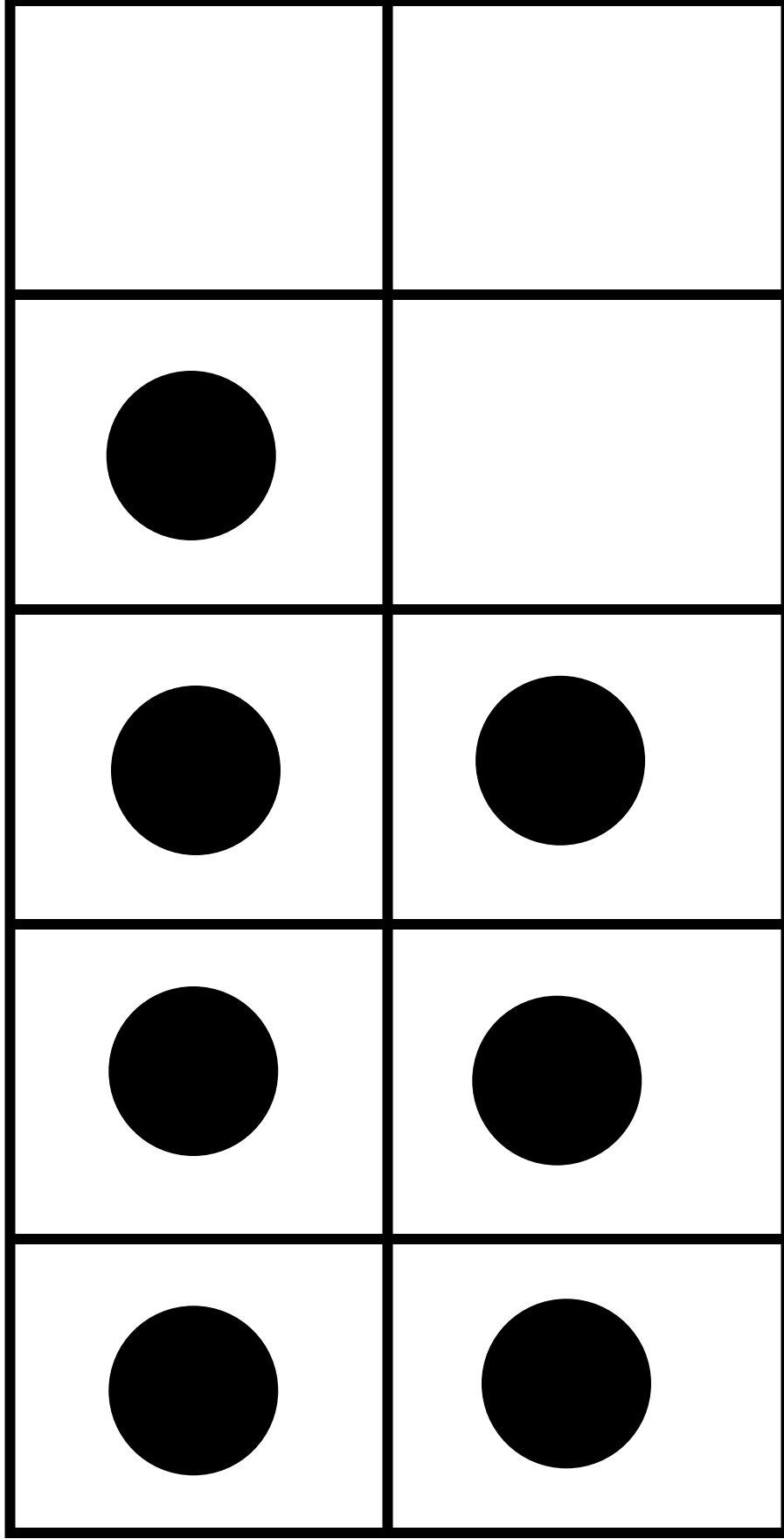

Large Ten Frames (continued)

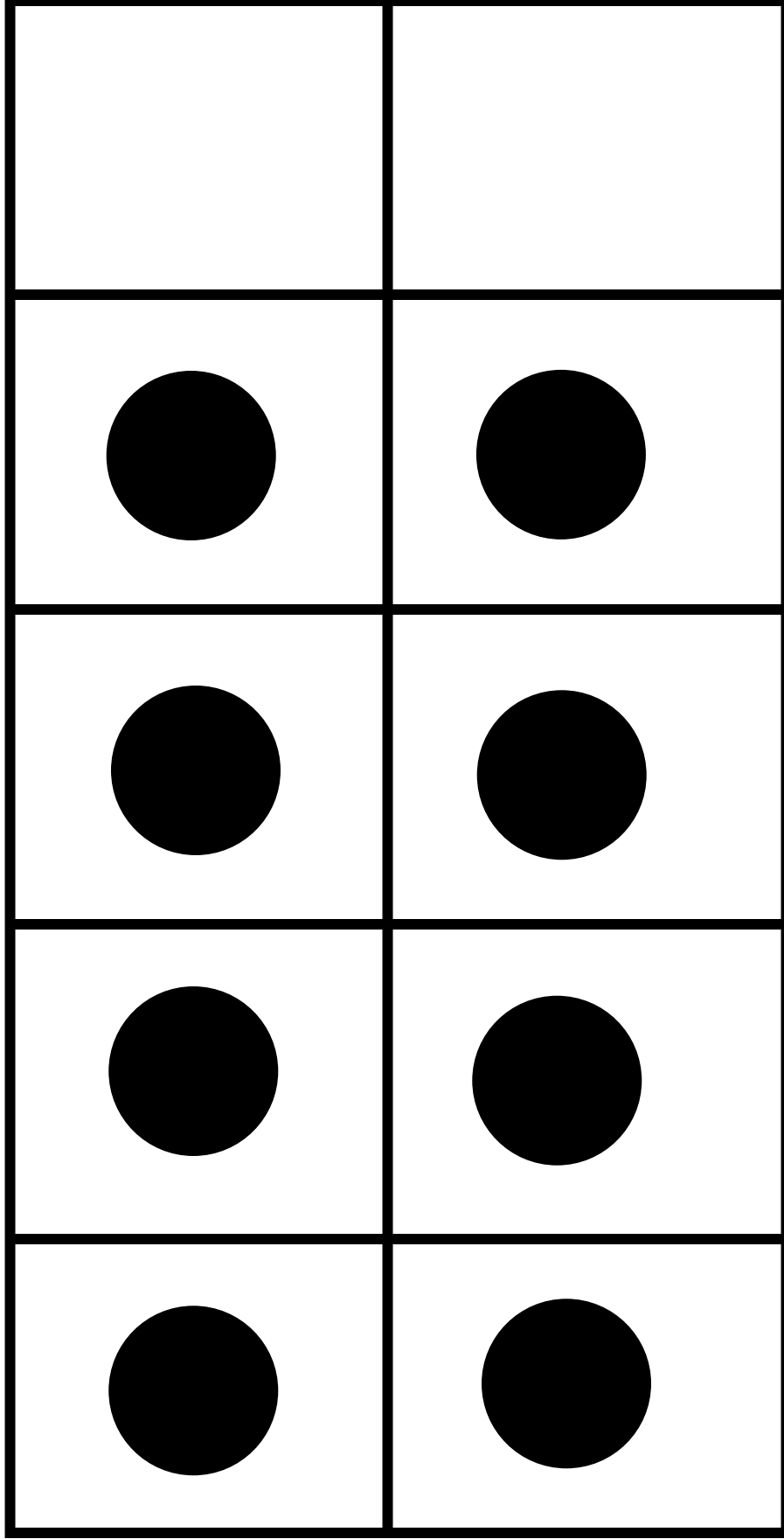

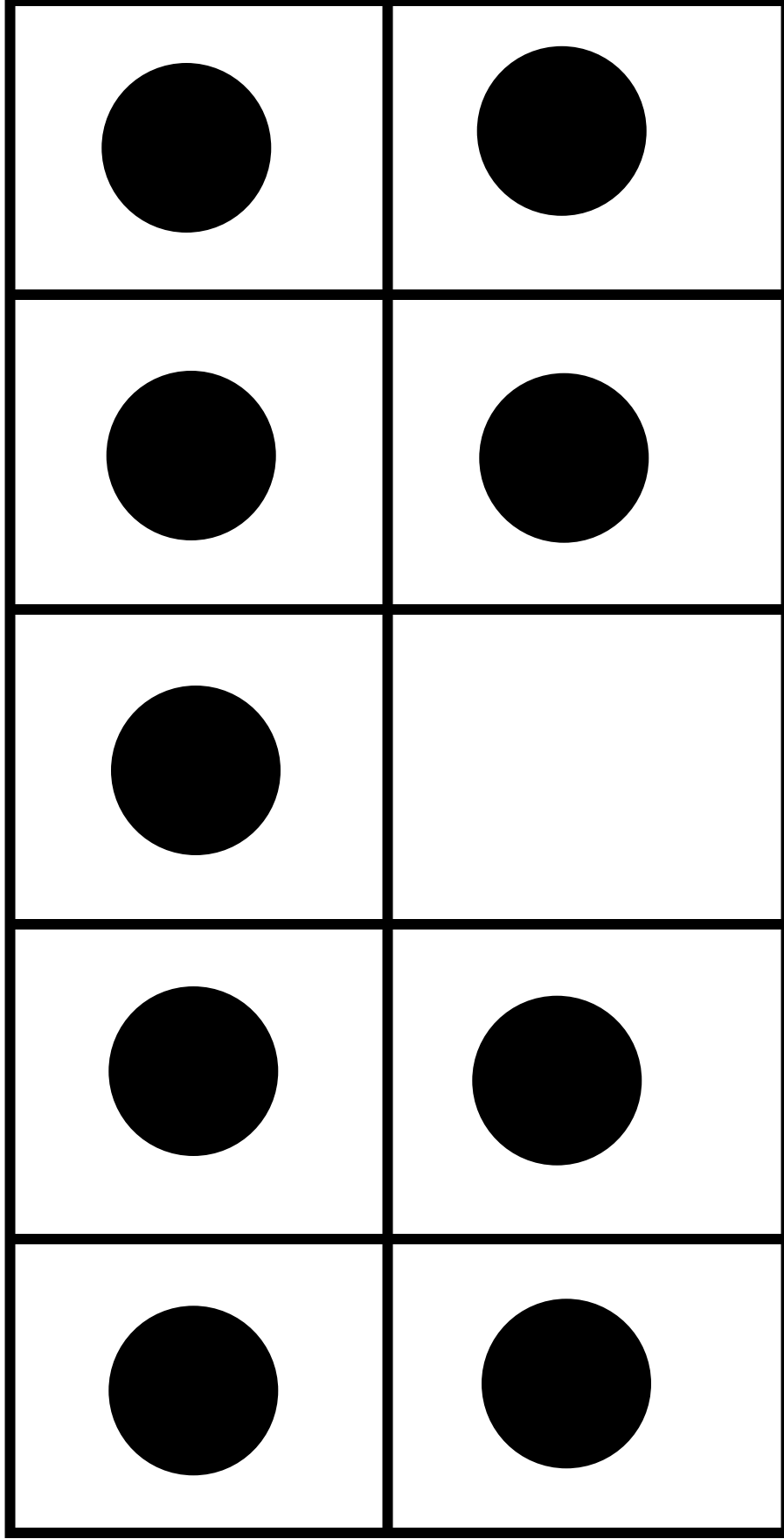

Large Ten Frames (continued)

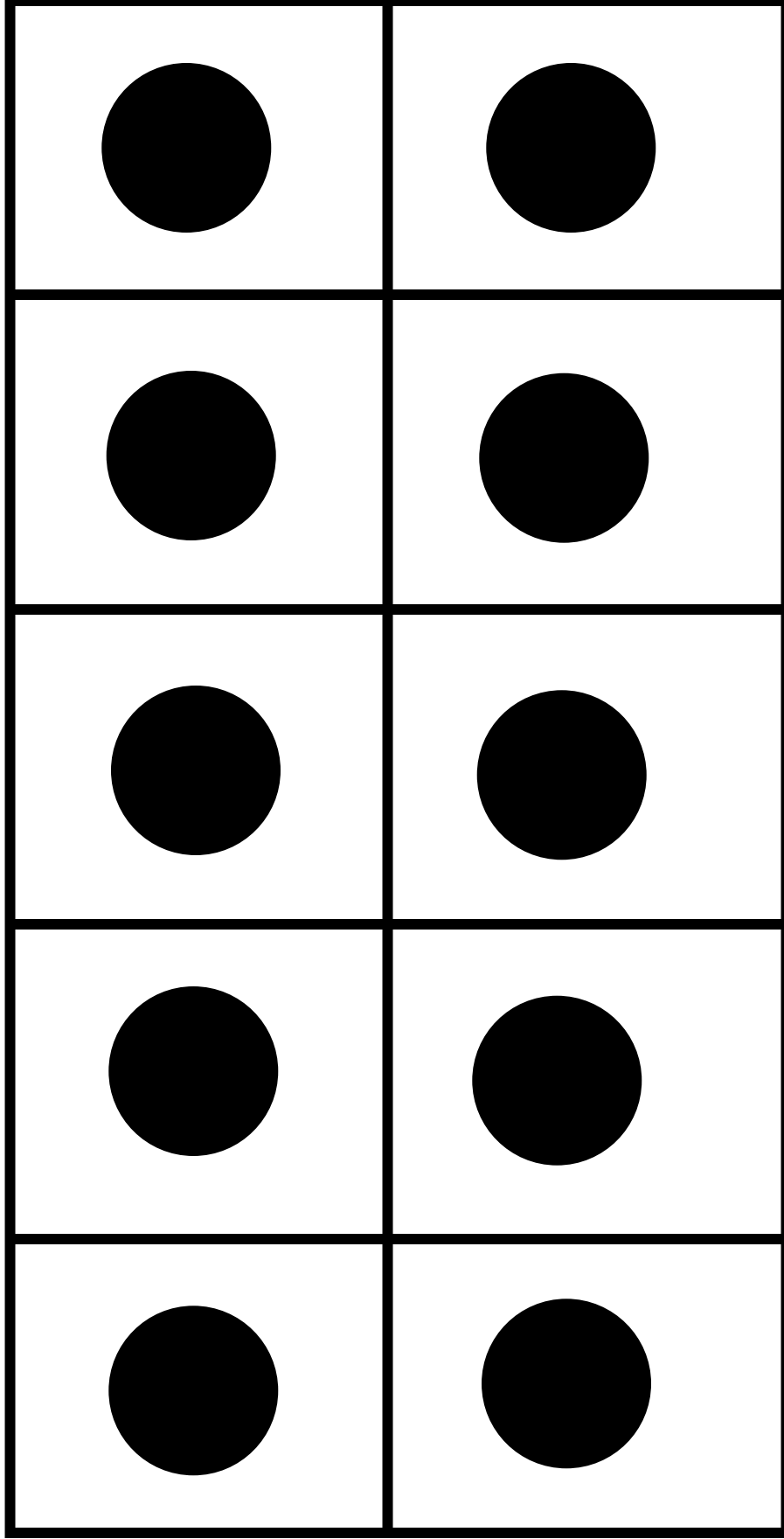

Large Ten Frames (continued)

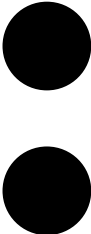

Regular Dot Cards

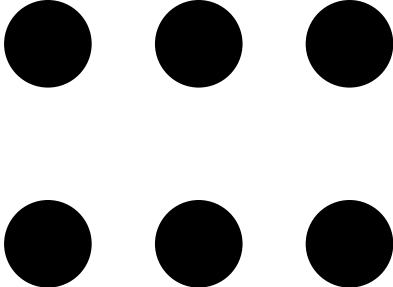
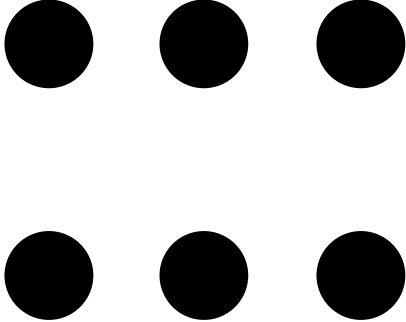
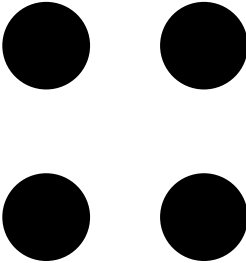
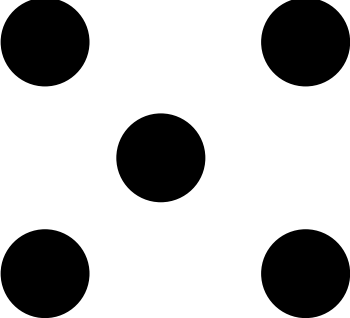
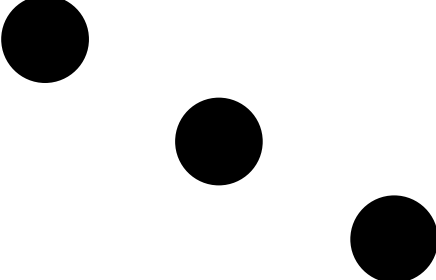
Dominoes (Double Six)

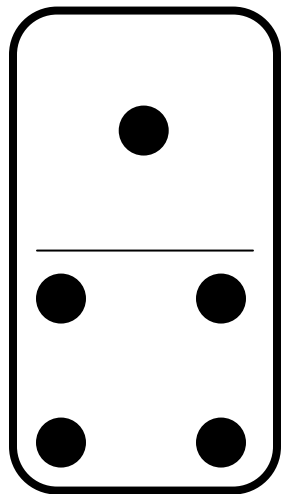
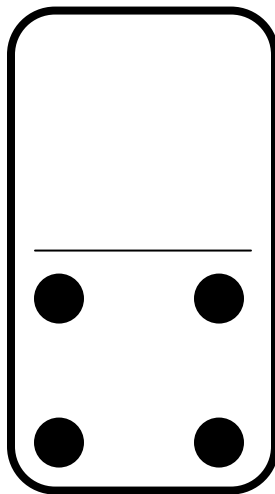
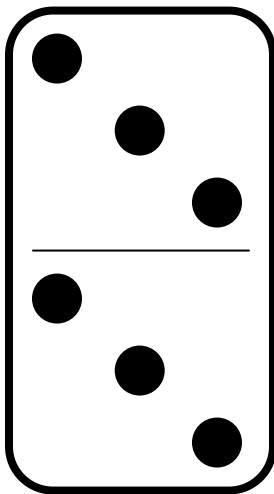
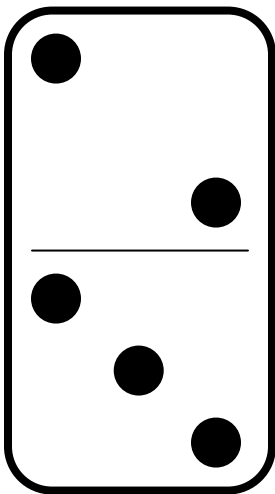
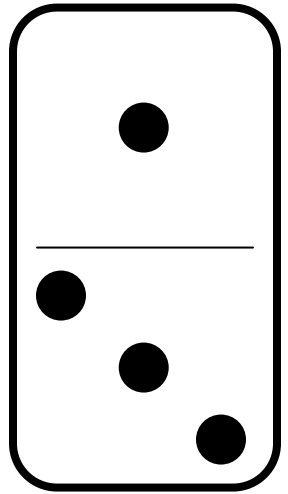
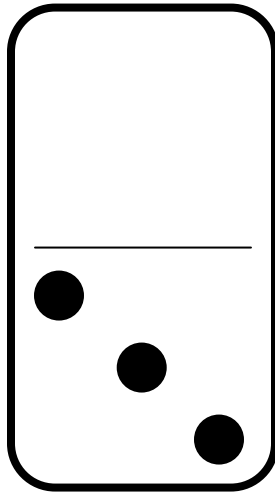
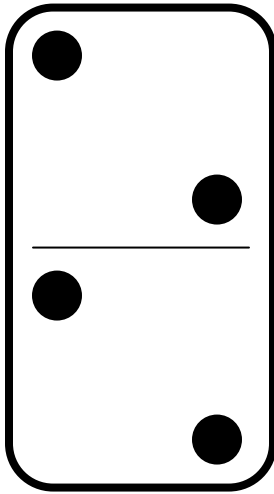
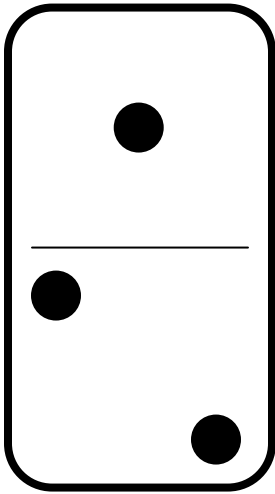
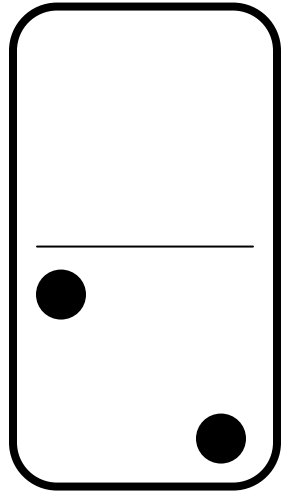
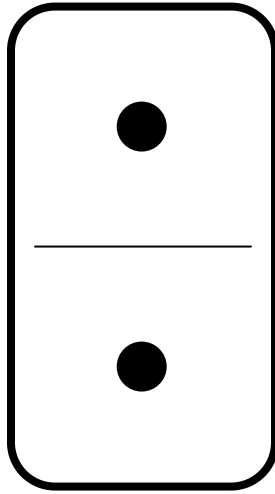
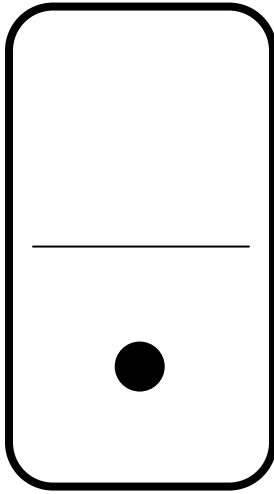
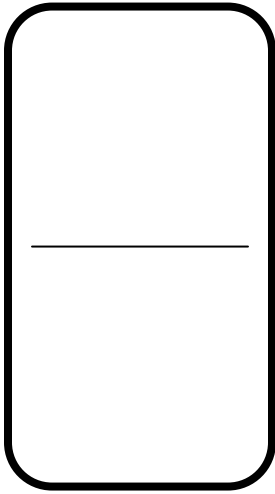

Dominoes (Double Six) (continued)

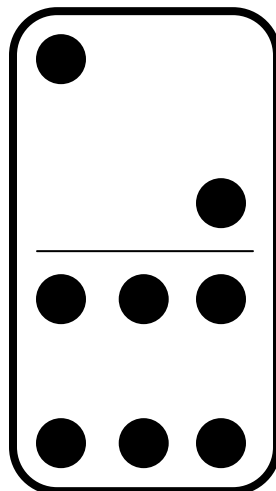
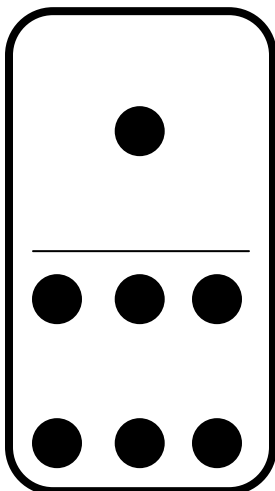
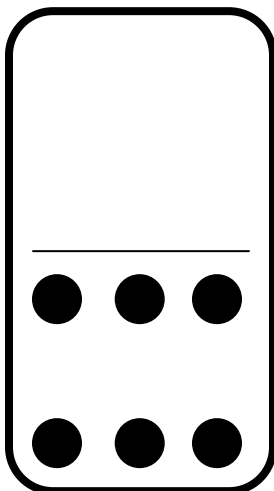
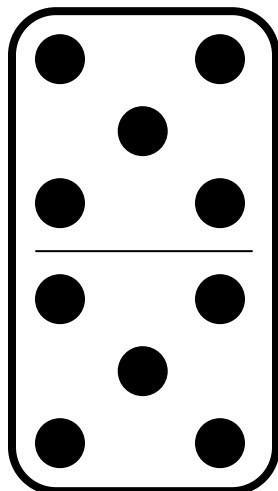
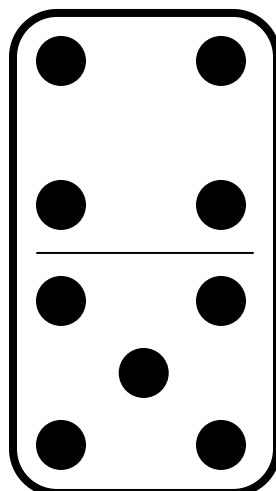
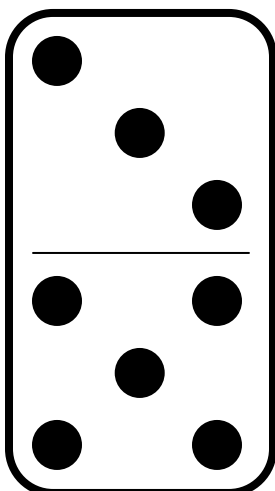
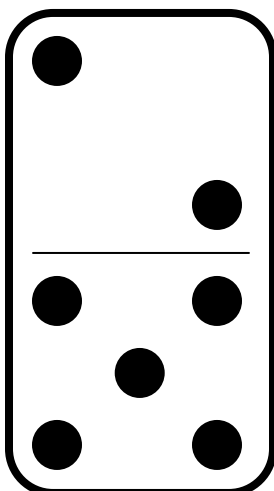
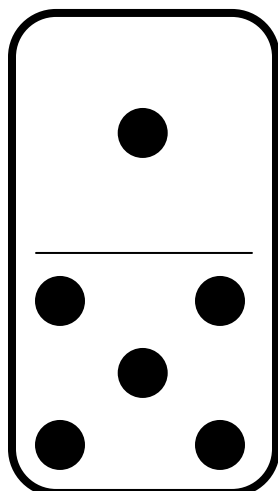
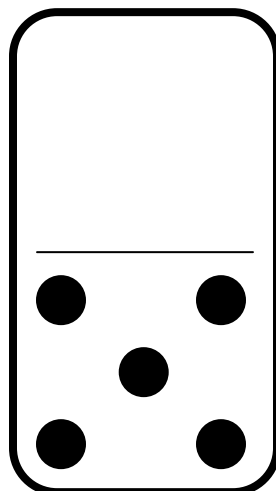
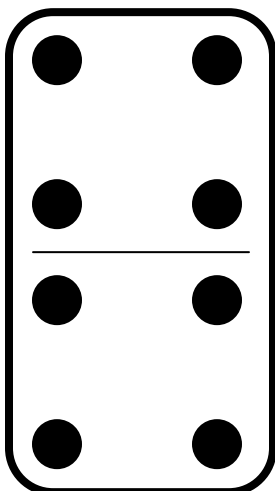
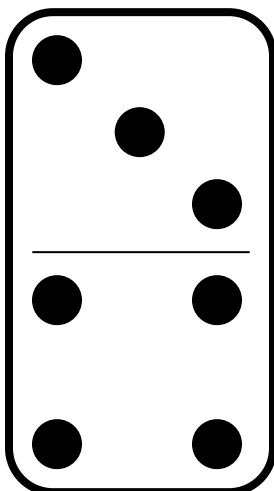
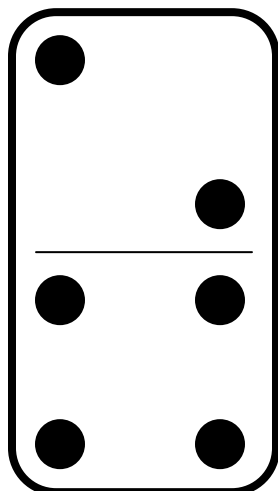

Dominoes (Double Six) (continued)

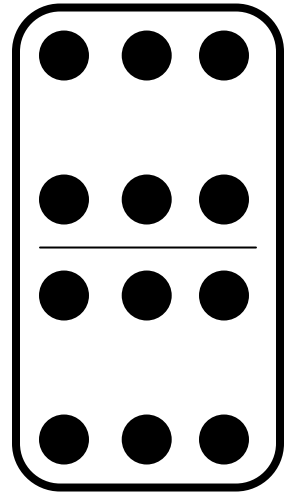
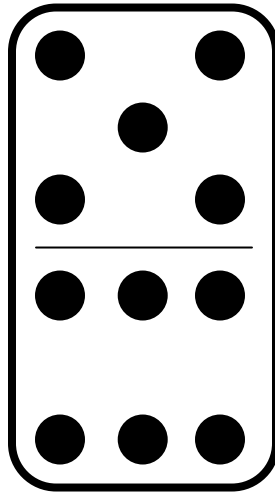
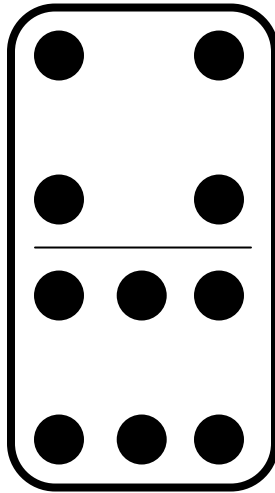
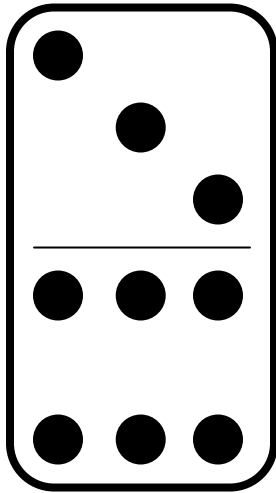

Finger Patterns

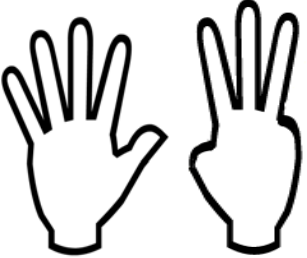
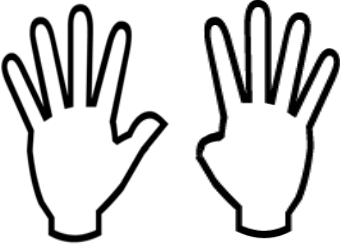
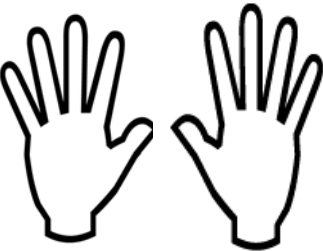

Finger Patterns (continued)

Finger Patterns (continued)

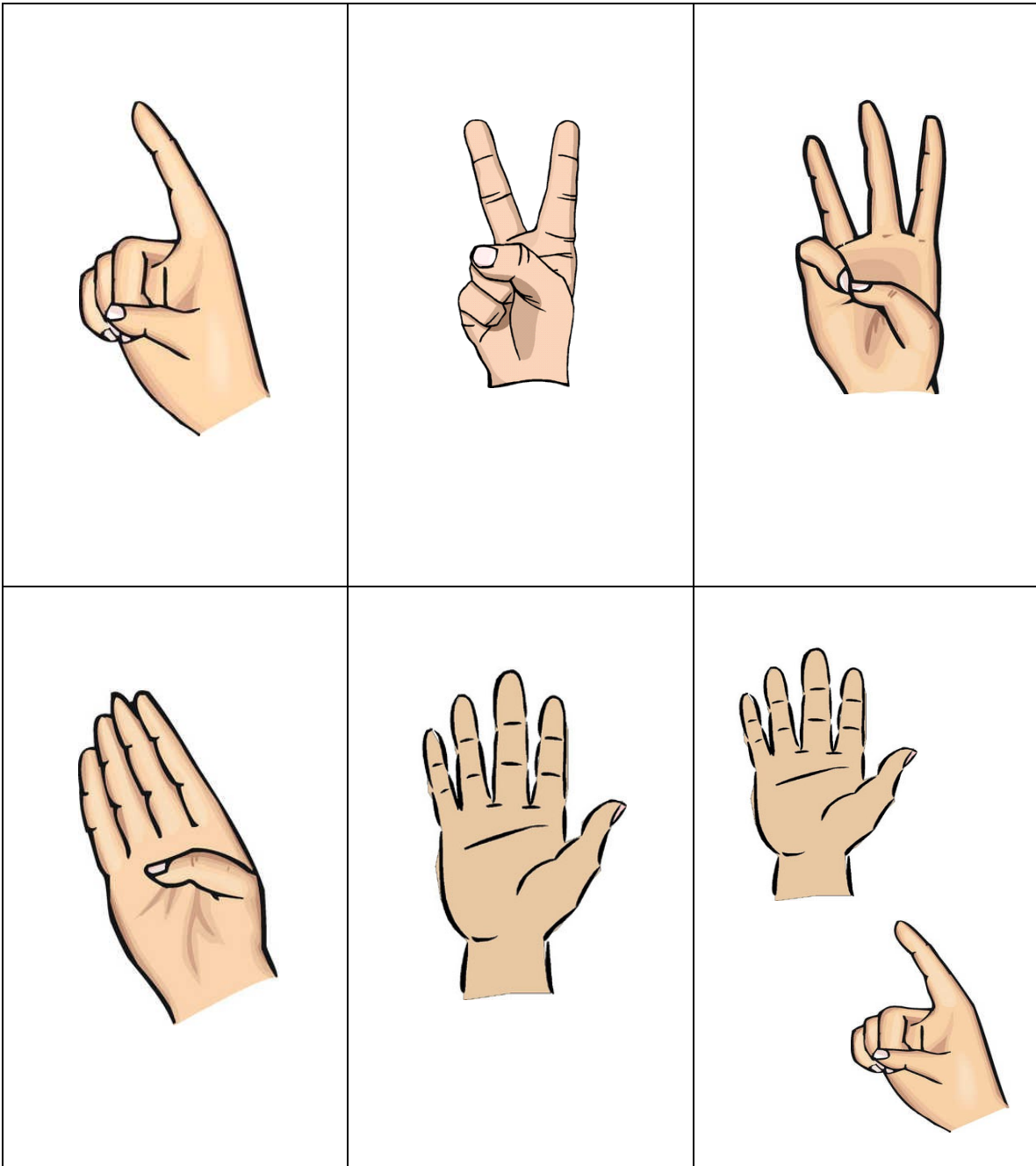

Finger Patterns (continued)

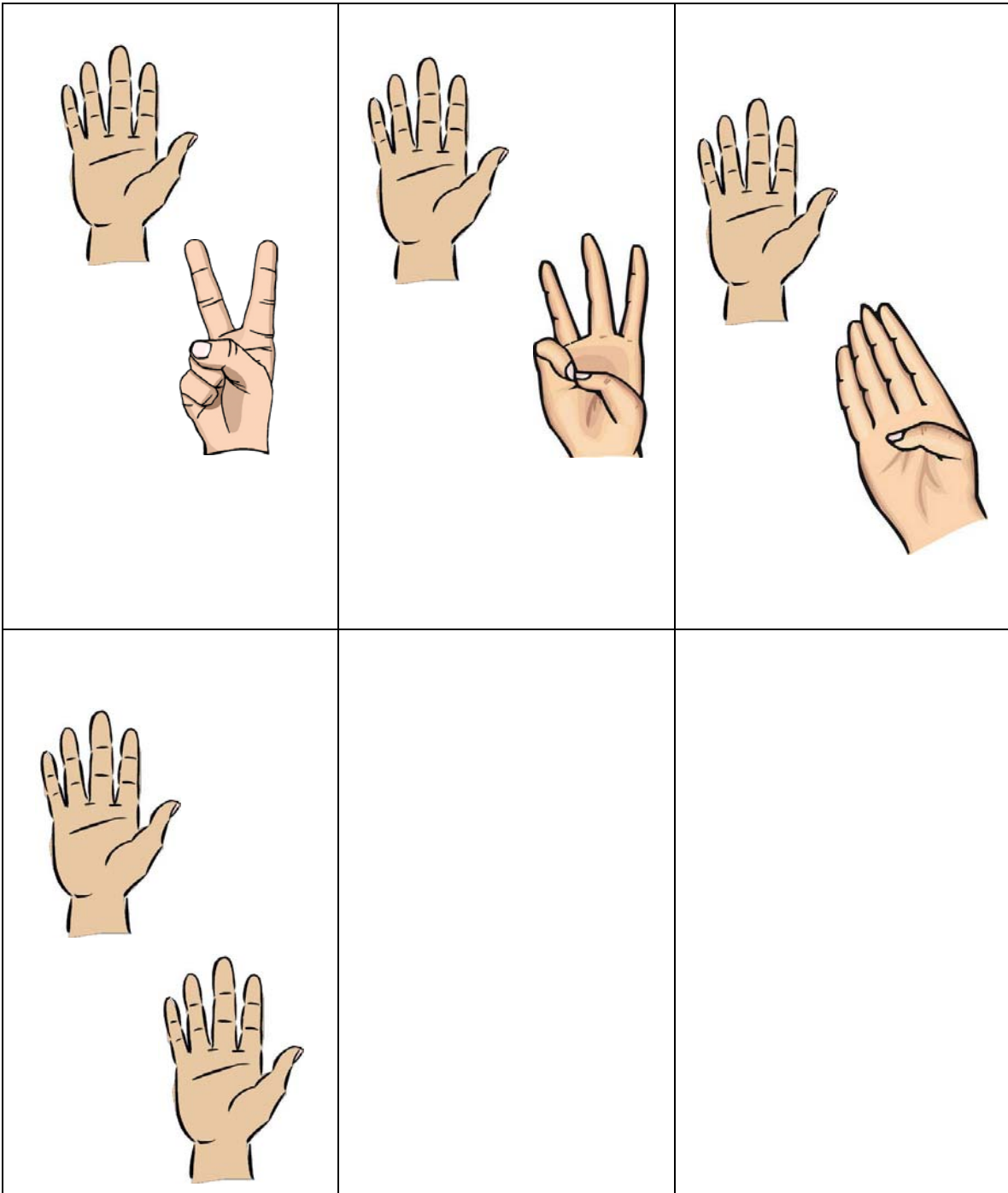

Matching Cards



1





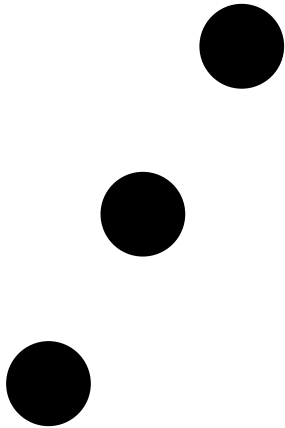
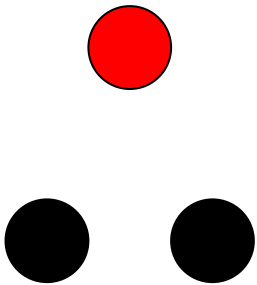

2





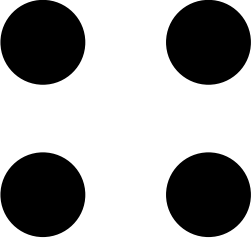
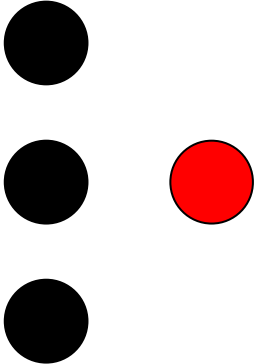

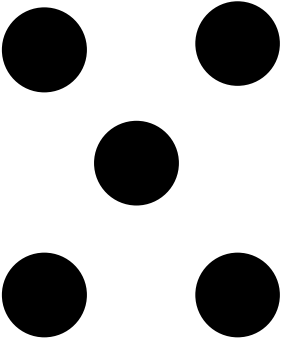
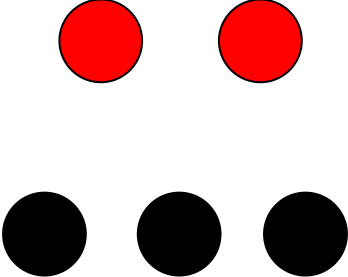
3

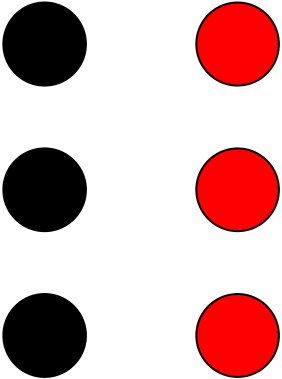
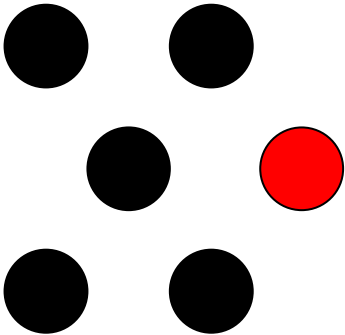
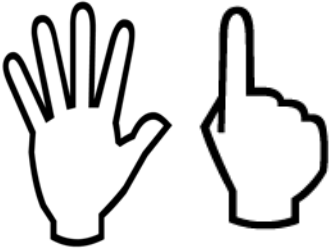

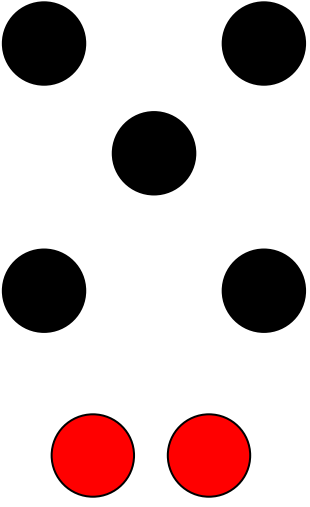
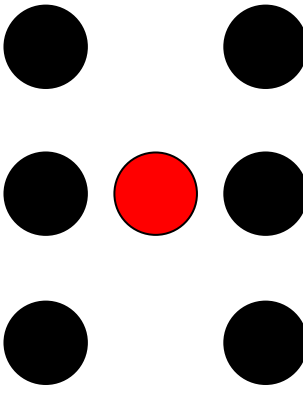

Matching Cards (continued)

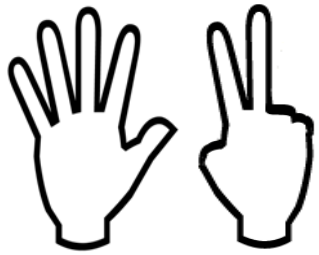
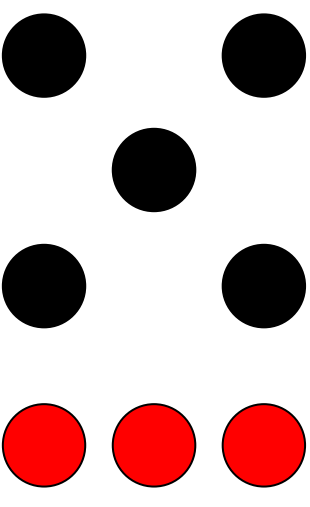
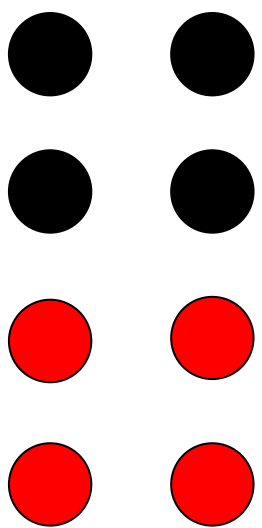
		<h1>4</h1>	
		<h1>5</h1>	
		<h1>6</h1> <hr data-bbox="938 1829 1084 1833"/>	

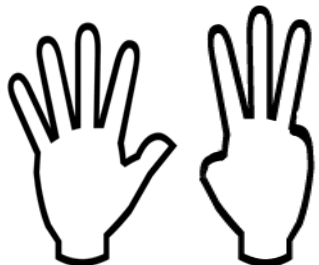
Matching Cards (continued)

Matching Cards (continued)

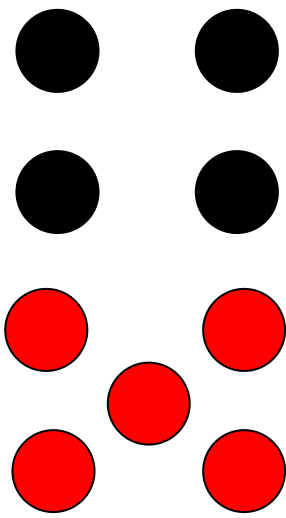
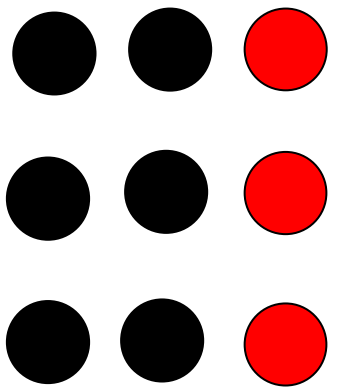
 <p>A card with 9 dots arranged in two columns. The left column has 6 black dots and 3 red dots. The right column has 4 black dots and 5 red dots.</p>	 <p>A card with 9 dots arranged in three rows. The top two rows have 2 black dots each. The bottom row has 2 black dots and 5 red dots.</p>	 <p>A card with the number 9 and a horizontal line below it.</p>	 <p>A card with two hands, palms facing forward.</p>
 <p>A card with 10 dots arranged in two columns. The left column has 4 black dots and 4 red dots. The right column has 2 black dots and 4 red dots.</p>	 <p>A card with 10 dots arranged in three rows. The top two rows have 2 black dots each. The bottom two rows have 3 red dots each.</p>	 <p>A card with the number 10.</p>	 <p>A card with two hands, palms facing forward.</p>

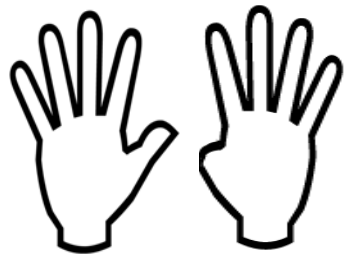
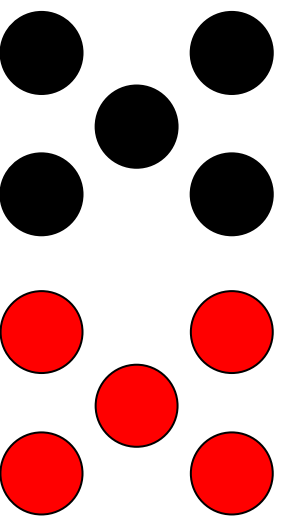
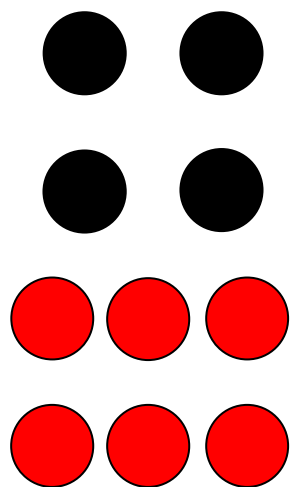
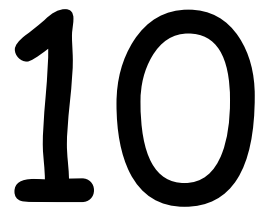
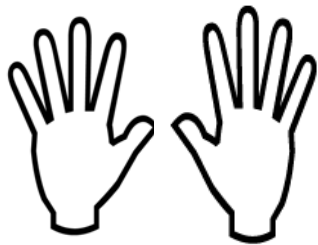
Flash Frames

Flash Frames (continued)

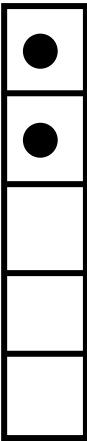
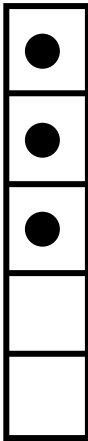
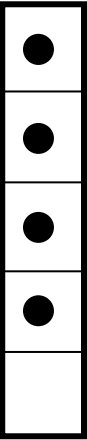
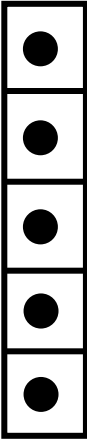
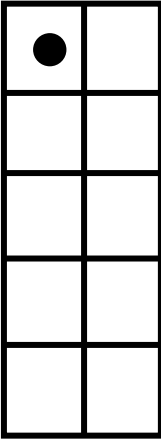
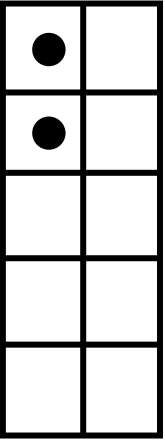
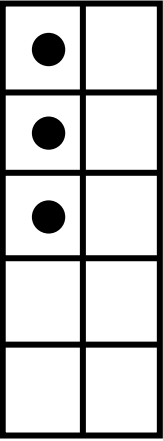
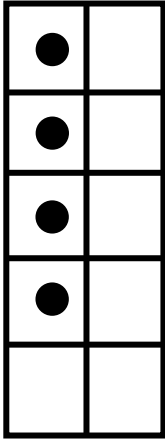
<table border="1"><tbody><tr><td>●</td><td></td></tr><tr><td>●</td><td></td></tr><tr><td>●</td><td></td></tr><tr><td>●</td><td></td></tr><tr><td>●</td><td></td></tr></tbody></table>	●		●		●		●		●		<table border="1"><tbody><tr><td>●</td><td>●</td></tr><tr><td>●</td><td></td></tr><tr><td>●</td><td></td></tr><tr><td>●</td><td></td></tr><tr><td>●</td><td></td></tr></tbody></table>	●	●	●		●		●		●		<table border="1"><tbody><tr><td>●</td><td>●</td></tr><tr><td>●</td><td>●</td></tr><tr><td>●</td><td></td></tr><tr><td>●</td><td></td></tr><tr><td>●</td><td></td></tr></tbody></table>	●	●	●	●	●		●		●	
●																																
●																																
●																																
●																																
●																																
●	●																															
●																																
●																																
●																																
●																																
●	●																															
●	●																															
●																																
●																																
●																																
<table border="1"><tbody><tr><td>●</td><td>●</td></tr><tr><td>●</td><td>●</td></tr><tr><td>●</td><td>●</td></tr><tr><td>●</td><td></td></tr><tr><td>●</td><td></td></tr></tbody></table>	●	●	●	●	●	●	●		●		<table border="1"><tbody><tr><td>●</td><td>●</td></tr><tr><td>●</td><td>●</td></tr><tr><td>●</td><td>●</td></tr><tr><td>●</td><td>●</td></tr><tr><td>●</td><td></td></tr></tbody></table>	●	●	●	●	●	●	●	●	●		<table border="1"><tbody><tr><td>●</td><td>●</td></tr><tr><td>●</td><td>●</td></tr><tr><td>●</td><td>●</td></tr><tr><td>●</td><td>●</td></tr><tr><td>●</td><td>●</td></tr></tbody></table>	●	●	●	●	●	●	●	●	●	●
●	●																															
●	●																															
●	●																															
●																																
●																																
●	●																															
●	●																															
●	●																															
●	●																															
●																																
●	●																															
●	●																															
●	●																															
●	●																															
●	●																															

Flash Frames (continued)

Flash Frames (continued)

Number Words and Numerals

1	2	3	4	5
6	7	8	9	10
11	12	13	14	15
16	17	18	19	20

Number Words and Numerals (continued)

one	six
two	seven
three	eight
four	nine
five	ten

Number Words and Numerals (continued)

eleven	sixteen
twelve	seventeen
thirteen	eighteen
fourteen	nineteen
fifteen	twenty

Part-Whole Board

The image shows a large rectangular frame with a double-line border. Inside this frame, there are three smaller rectangular boxes. On the left side, there is a large vertical rectangle with a thick black border. On the right side, there are two smaller vertical rectangles, one above the other, both with thin black borders. These boxes are intended for students to draw or write parts of a whole.

Dominoes (Double Nine)

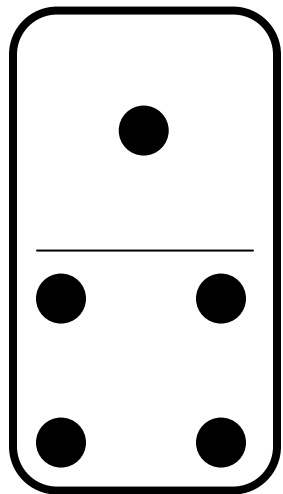
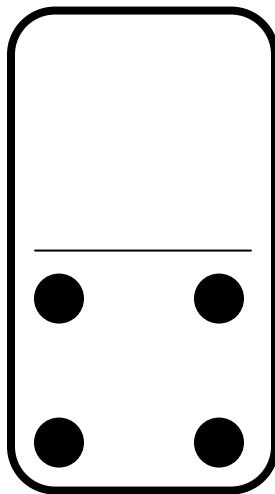
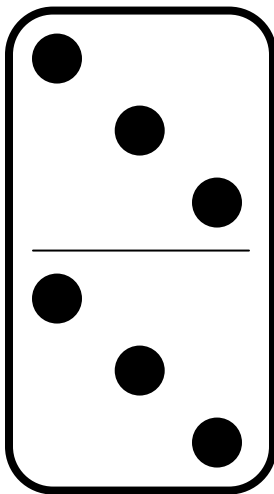
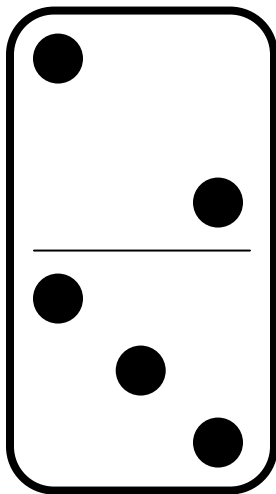
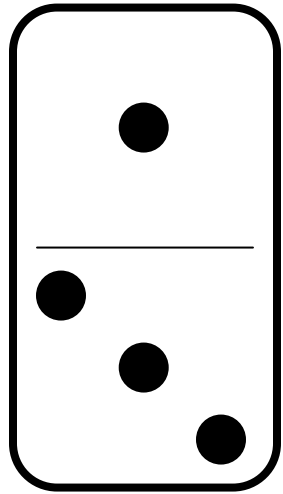
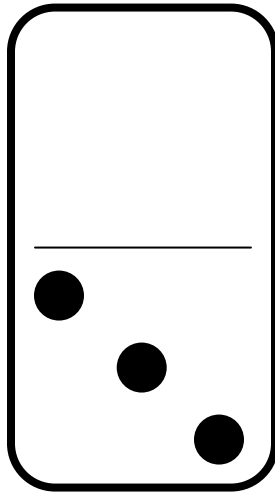
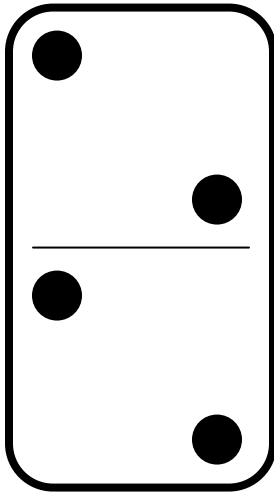
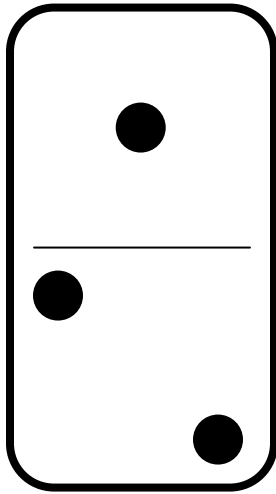
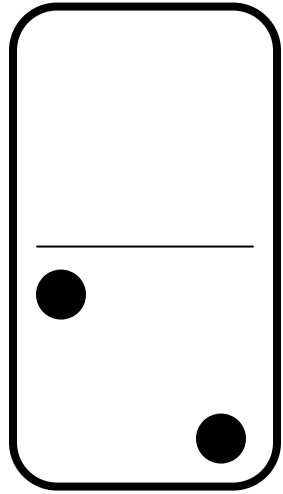
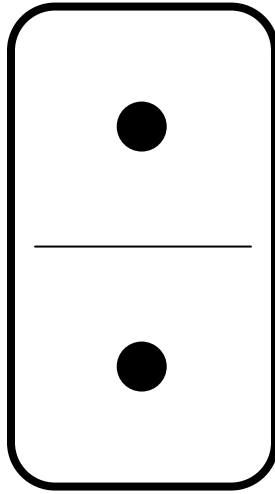
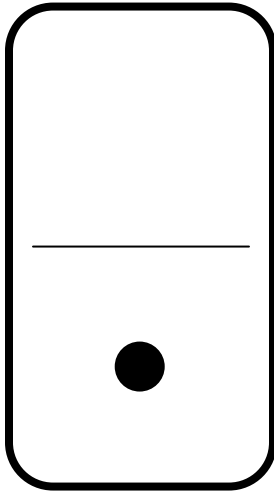
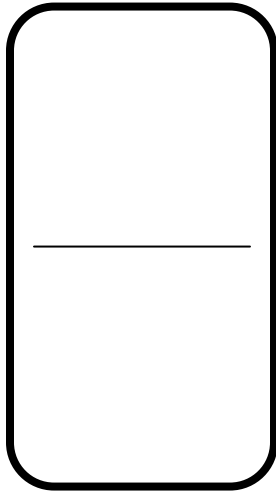

Dominoes (Double Nine) (continued)

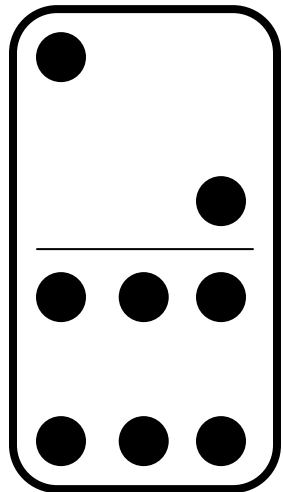
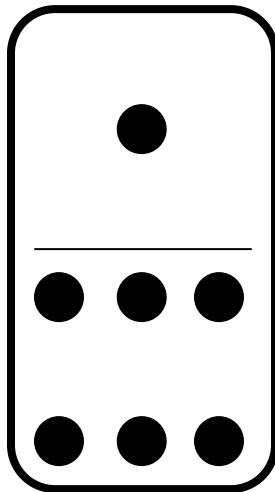
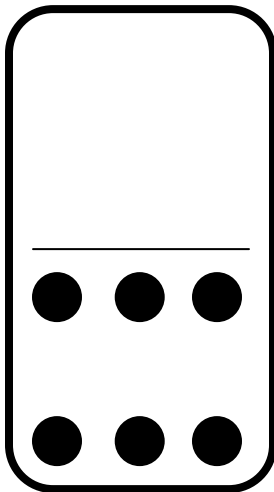
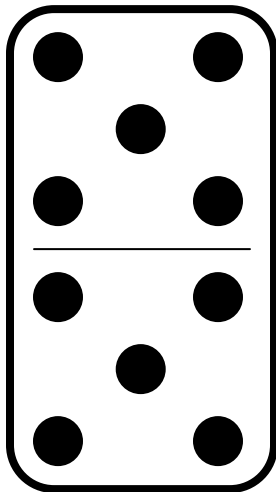
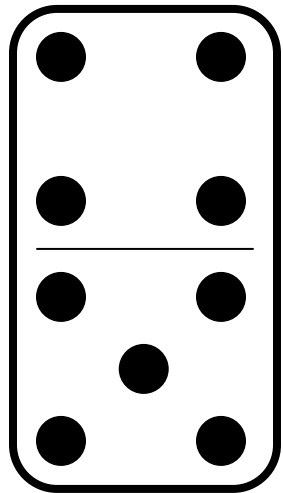
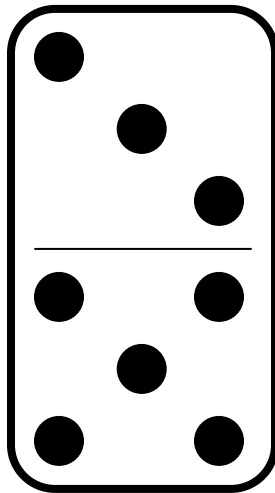
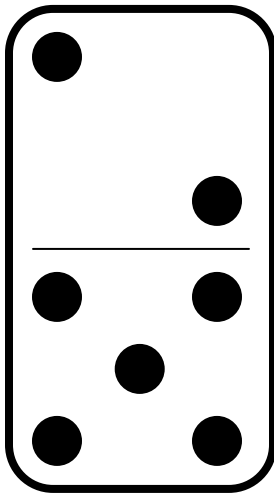
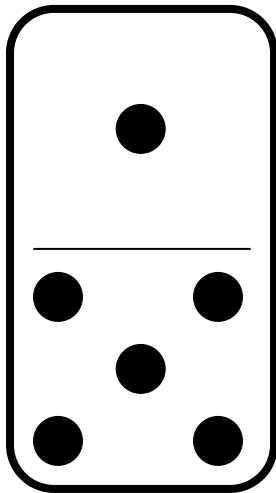
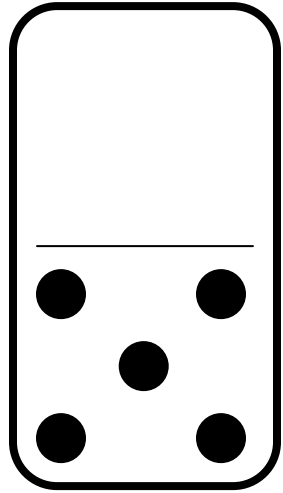
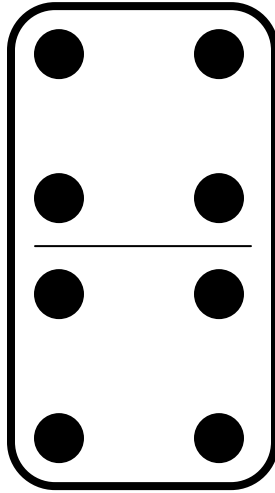
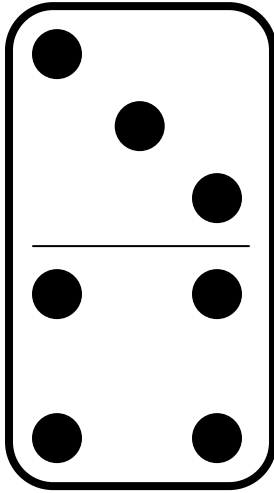
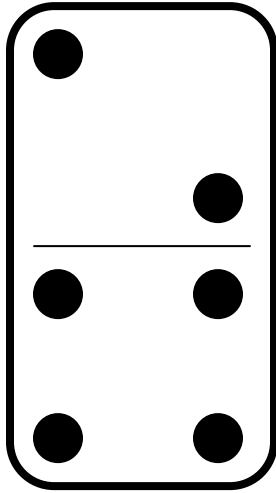

Dominoes (Double Nine) (continued)

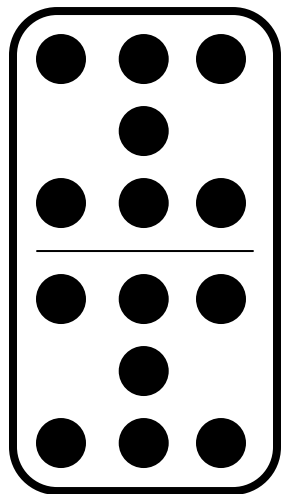
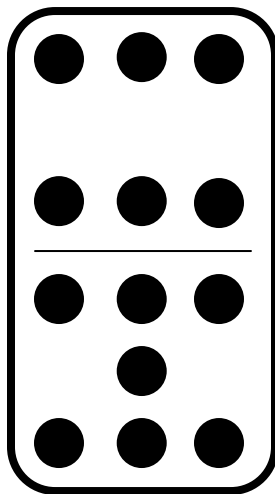
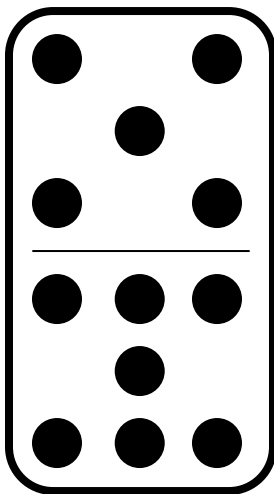
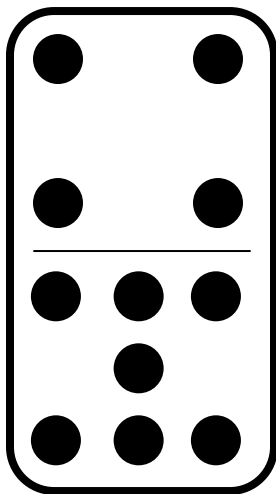
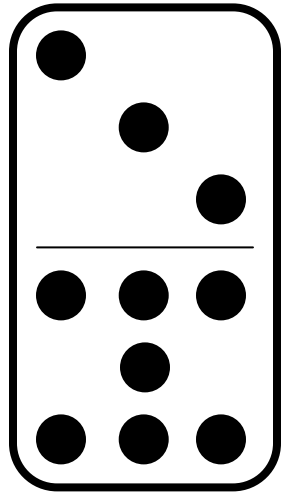
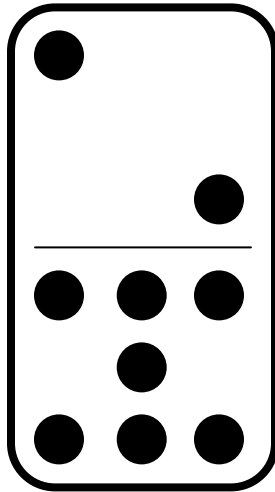
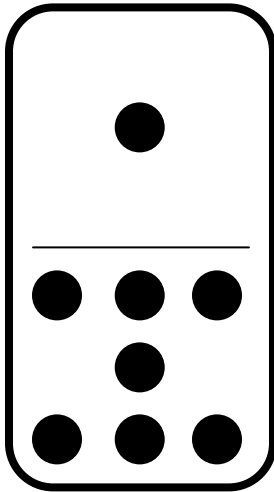
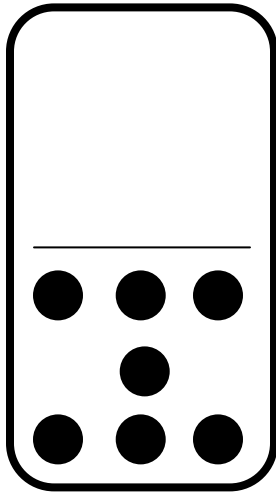
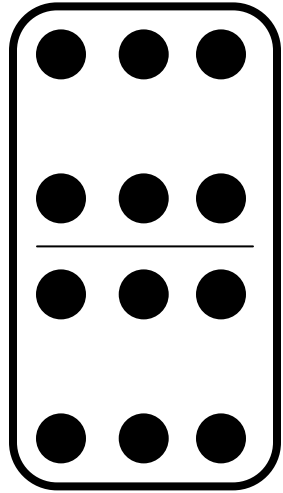
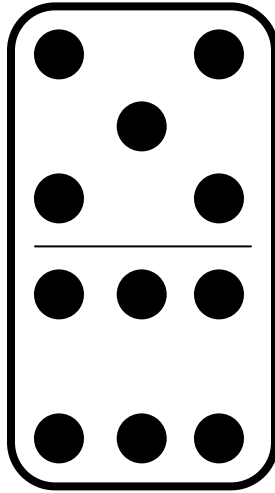
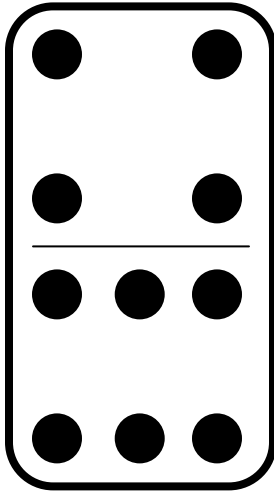
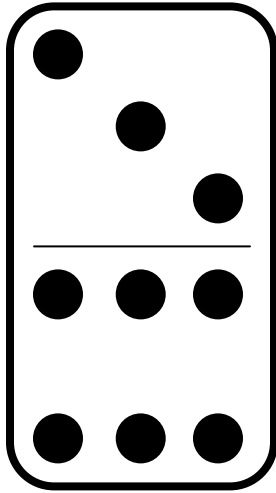

Dominoes (Double Nine) (continued)

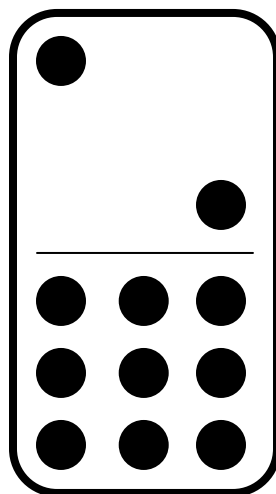
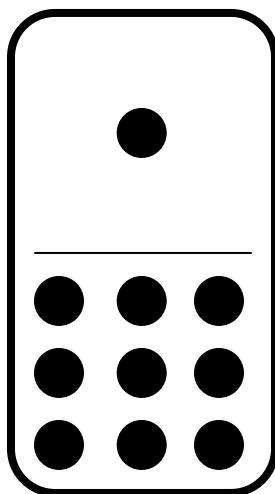
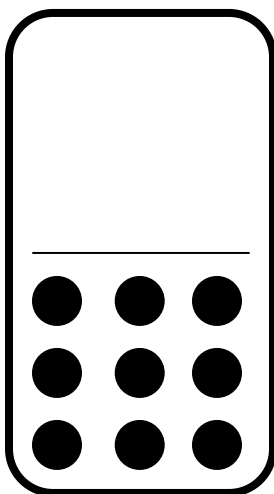
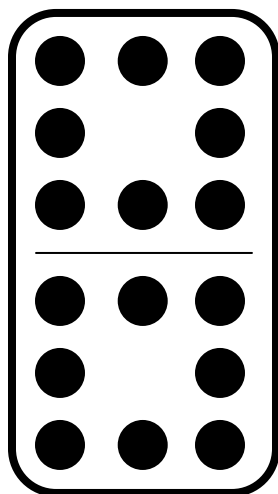
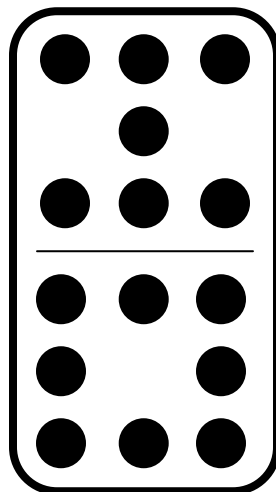
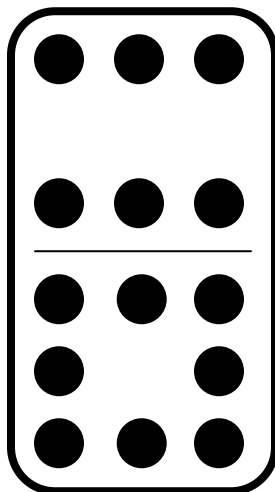
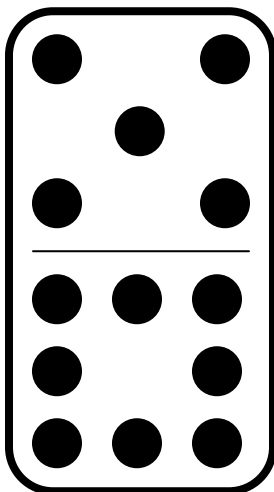
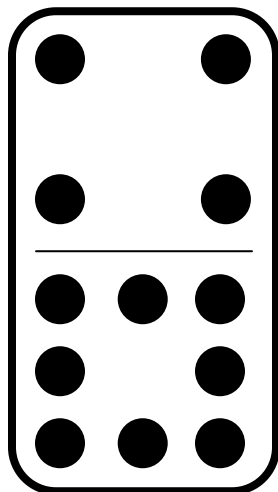
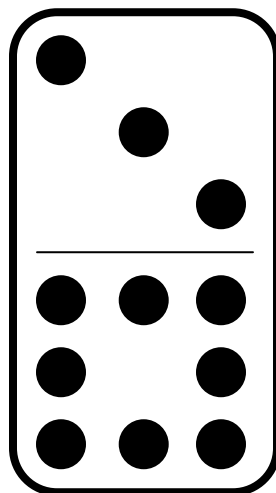
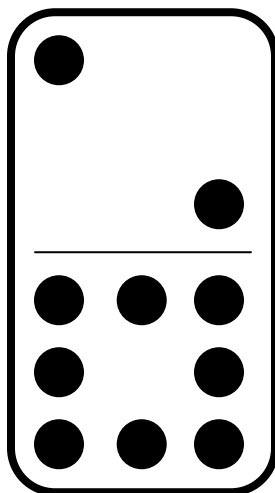
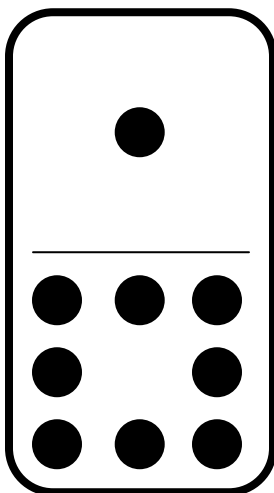
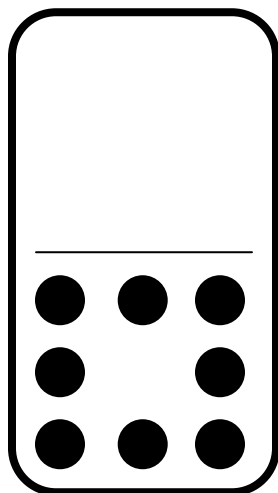

Dominoes (Double Nine) (continued)

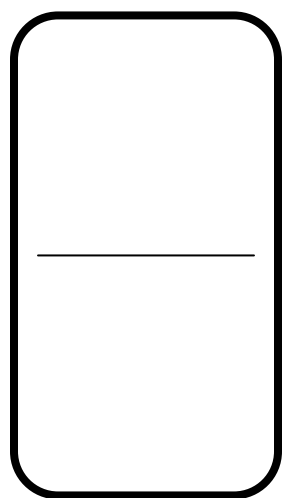
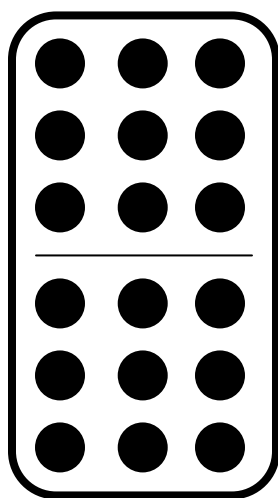
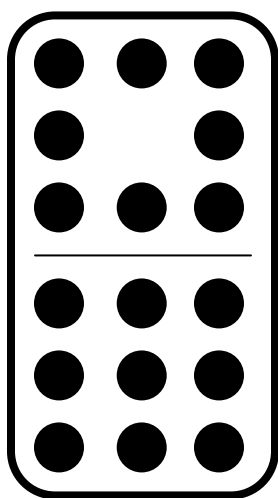
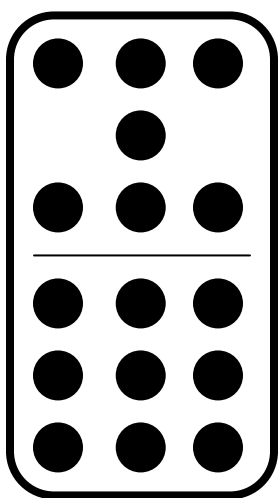
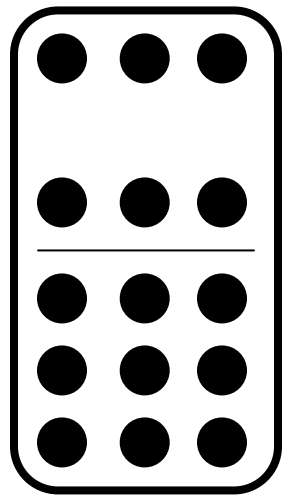
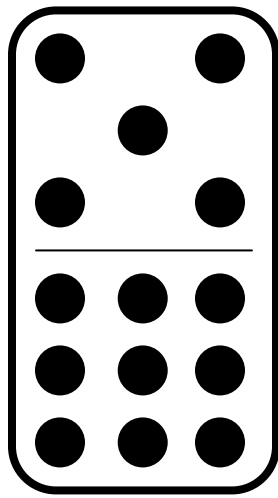
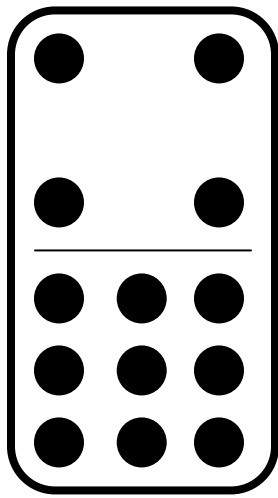
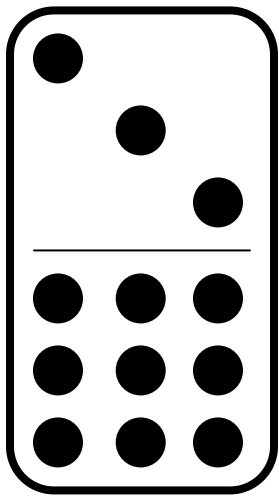

How Many More?

Materials: Game Grid for each student
Game markers
Number Cards

Directions: Decide on a target number (5 to 20)
Write all the numbers between 0 and the target number on the grid below. Put one number in each square. Numbers can be written more than once.

Cover the compatible/complementary number of the number that is called out. Cover one number at a time. If the target number is 10 and 6 is called out, the player would cover 4. The first player to get three in a row is the winner.

Variation: Make the grid larger and the winner who gets four in a row is the winner.

How Many More? (continued)

Target Number:

How Many More? (continued)

1	2	3	4	5
6	7	8	9	10
11	12	13	14	15
16	17	18	19	20

Clothesline Numbers

1

2

3

4

5

6

7

8

9

Clothesline Numbers (continued)

10

11

12

13

14

15

16

17

18

Clothesline Numbers (continued)

19	20	21
22	23	24
25	26	27

Clothesline Numbers (continued)

28	29	30
31	32	33
34	35	36

Clothesline Numbers (continued)

37	38	39
40	41	42
43	44	45

Clothesline Numbers (continued)

46	47	48
----	----	----

49	50	51
----	----	----

52	53	54
----	----	----

Clothesline Numbers (continued)

55	56	57
58	59	60
61	62	63

Clothesline Numbers (continued)

64	65	66
67	68	69
70	71	72

Clothesline Numbers (continued)

73	74	75
----	----	----

76	77	78
----	----	----

79	80	81
----	----	----

Clothesline Numbers (continued)

82

83

84

85

86

87

88

89

90

Clothesline Numbers (continued)

91

92

93

94

95

96

97

98

99

Clothesline Numbers (continued)

100

Clothesline Numbers: Multiples of 10

10

20

30

40

50

60

70

80

90

Clothesline Numbers: Multiples of 10 (continued)

100

Dot Cards to 20

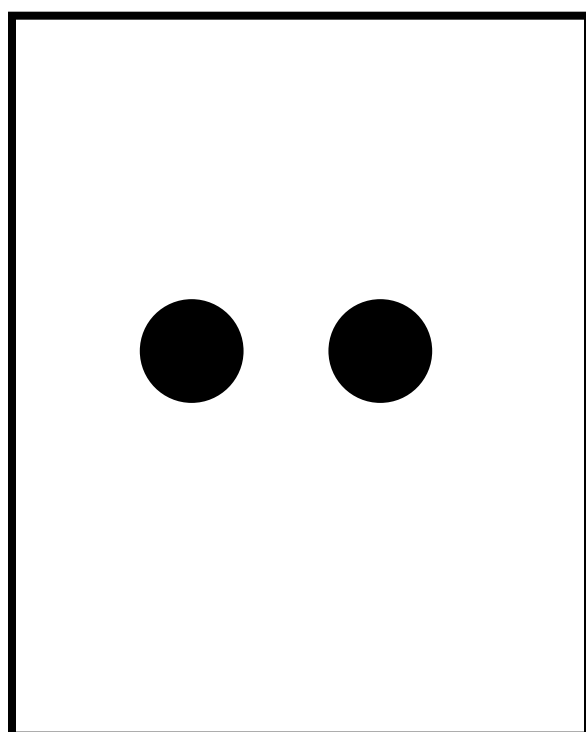
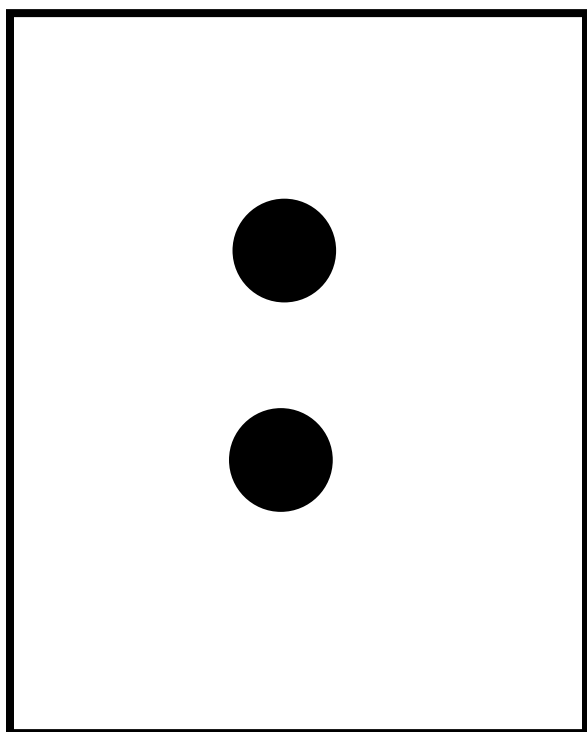
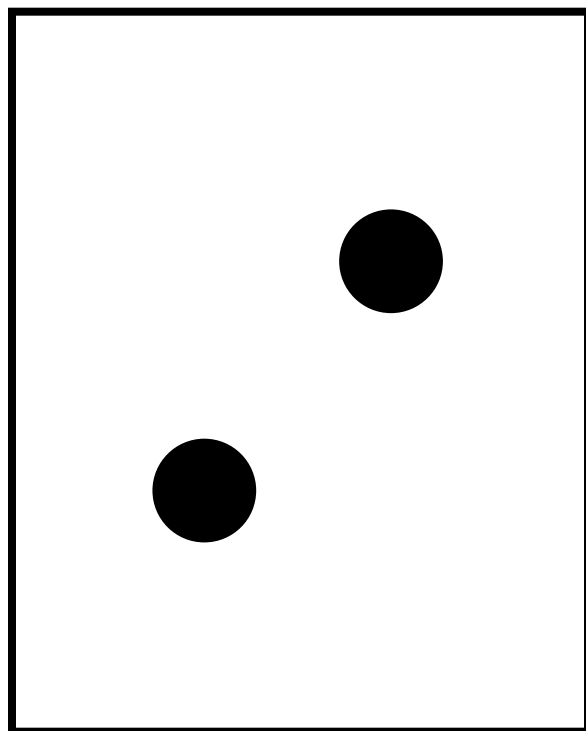
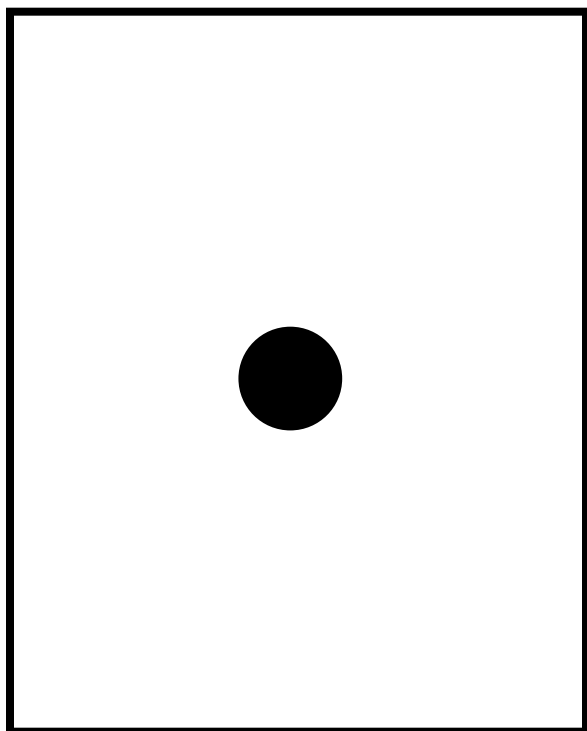

Dot Cards to 20 (continued)

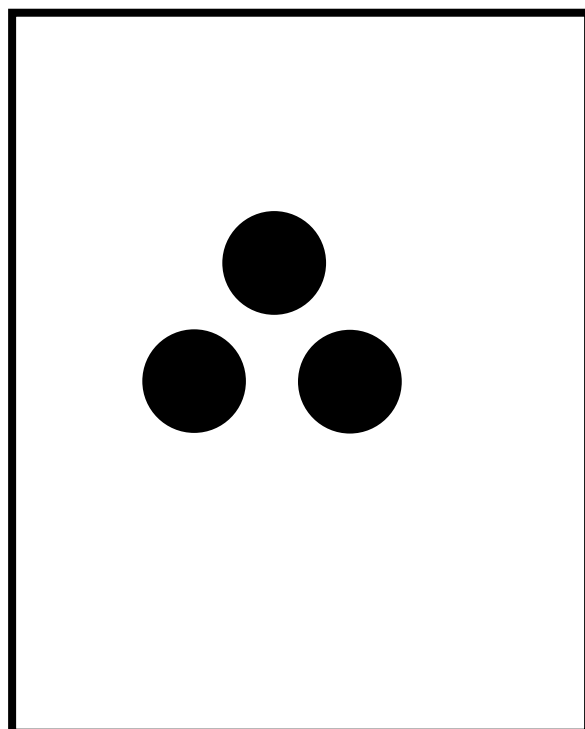
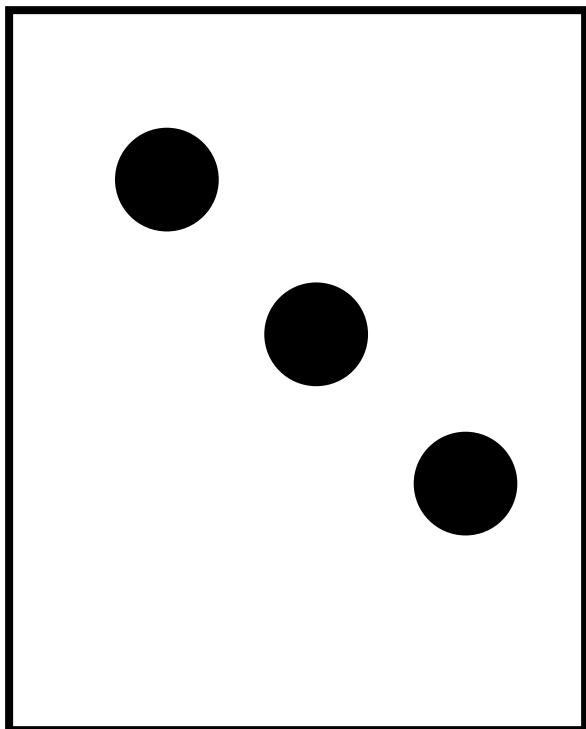
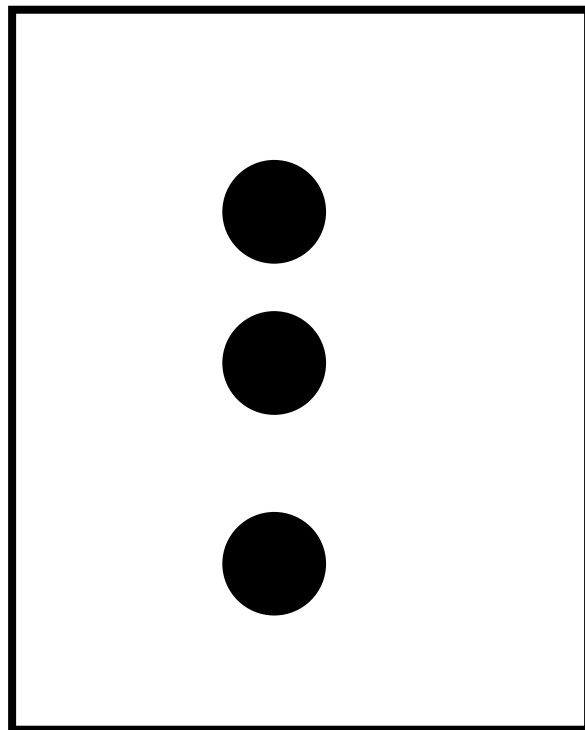
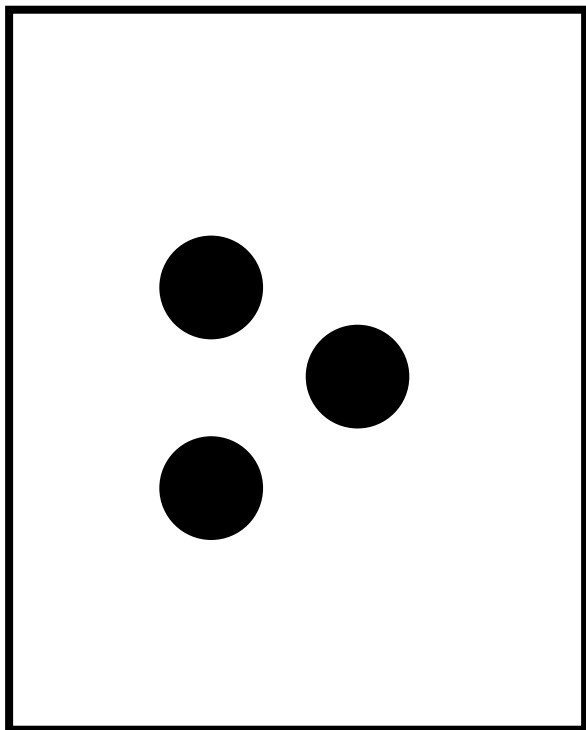

Dot Cards to 20 (continued)

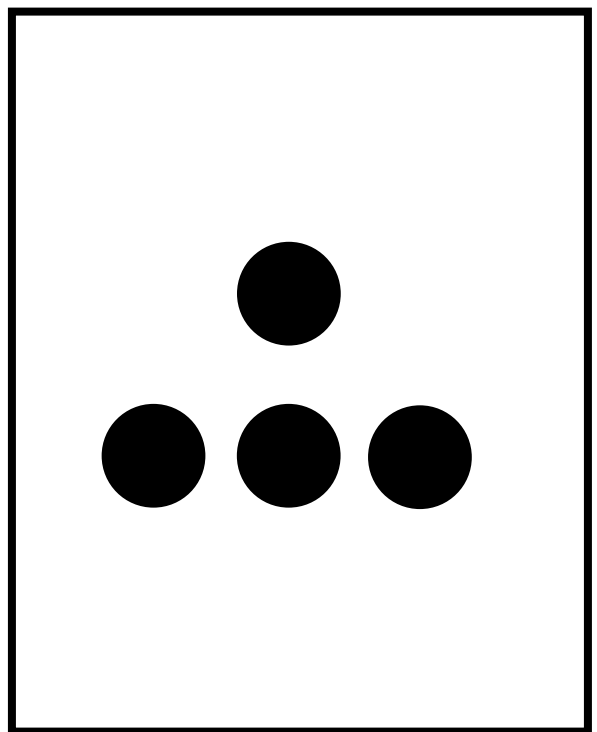
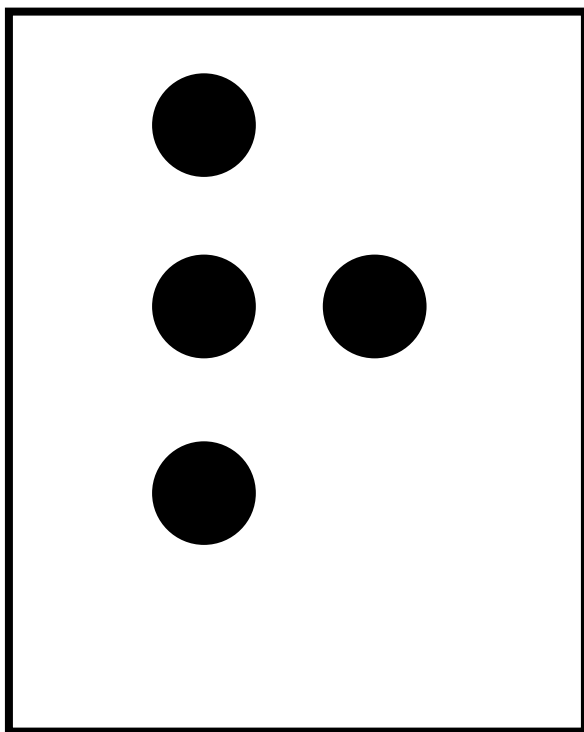
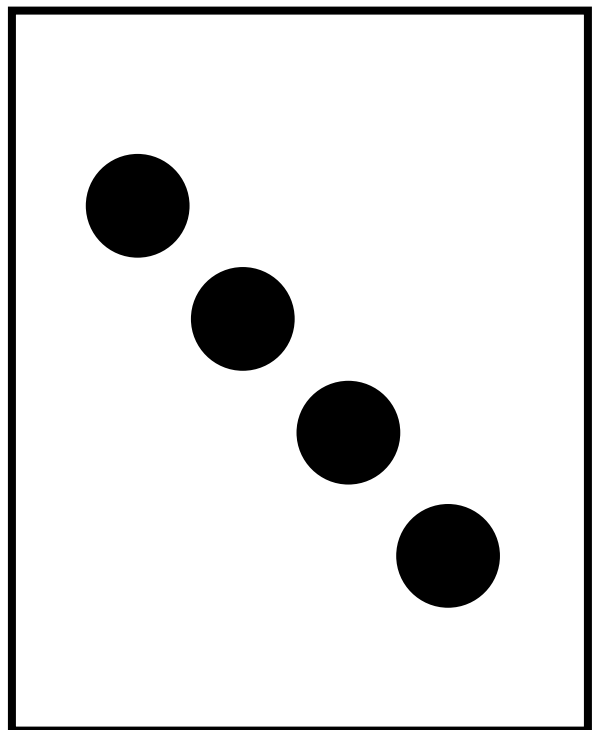
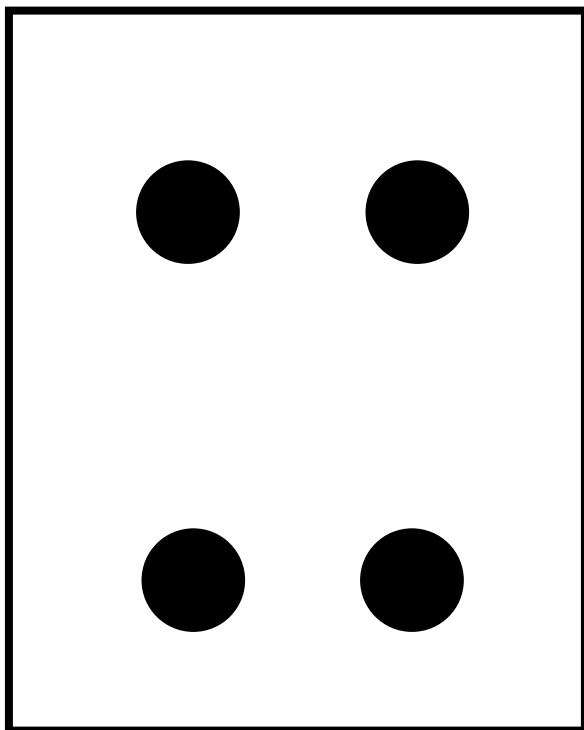

Dot Cards to 20 (continued)

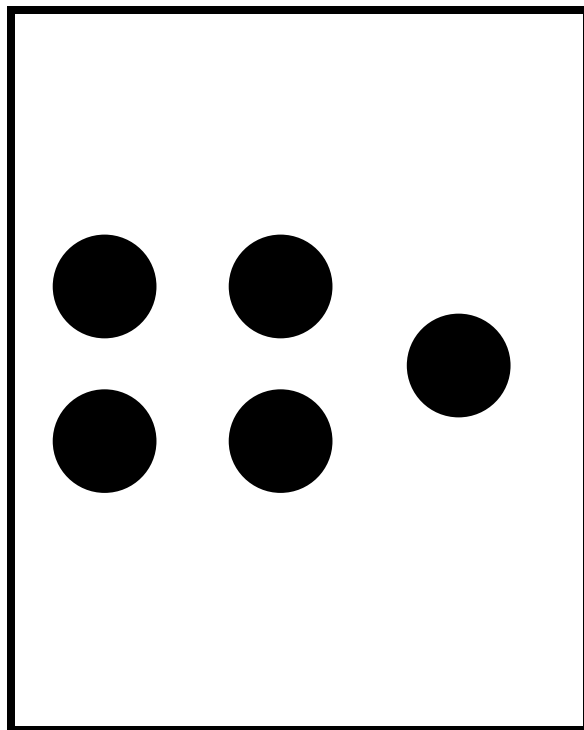
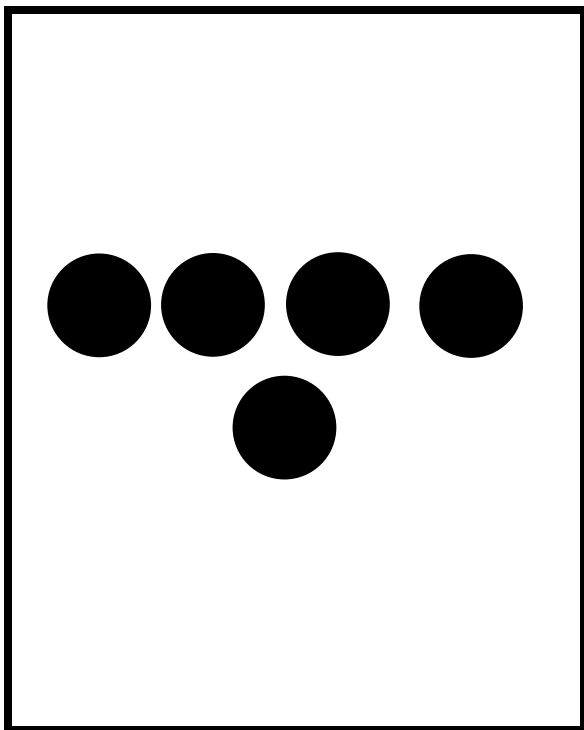
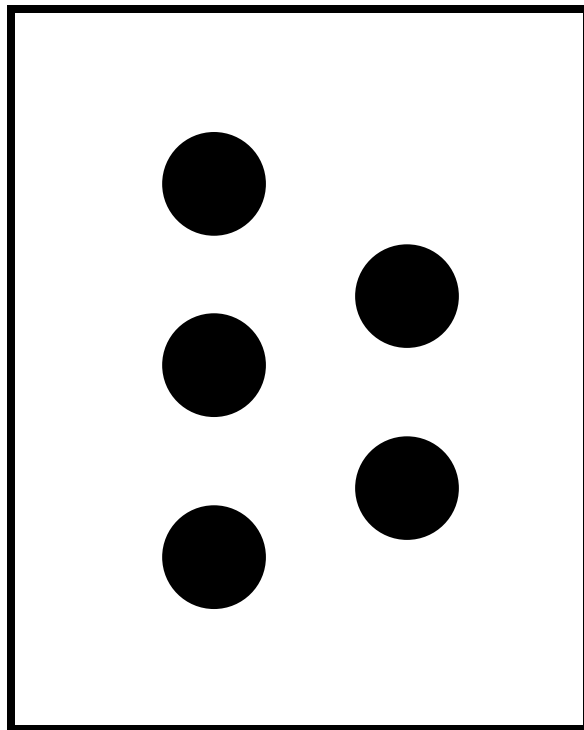
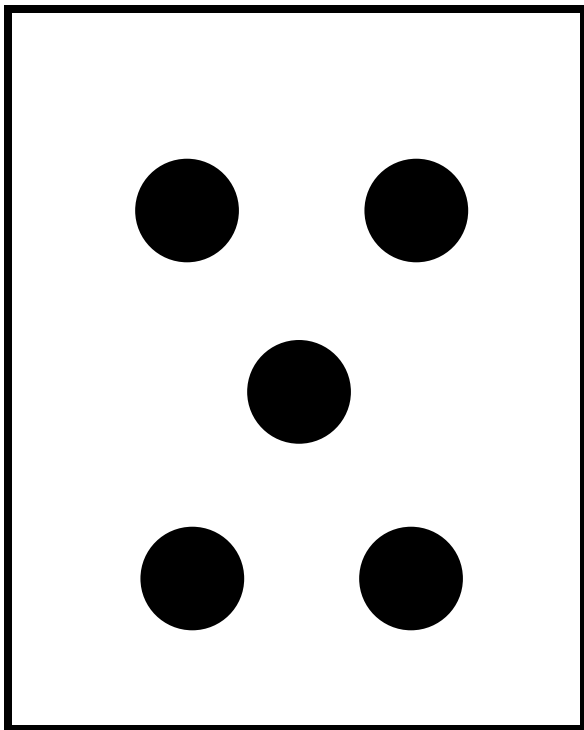

Dot Cards to 20 (continued)

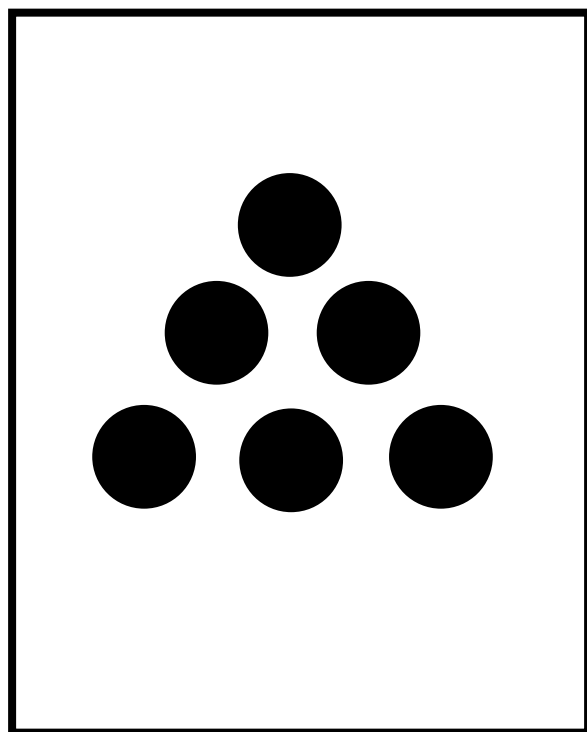
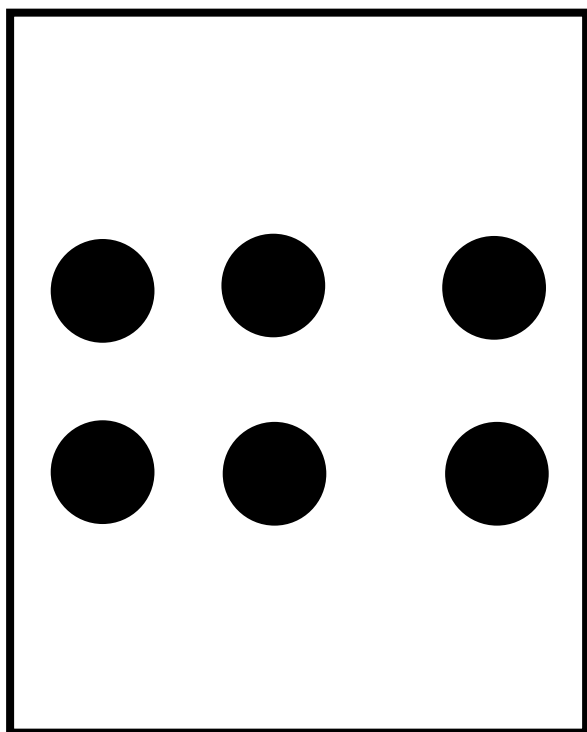
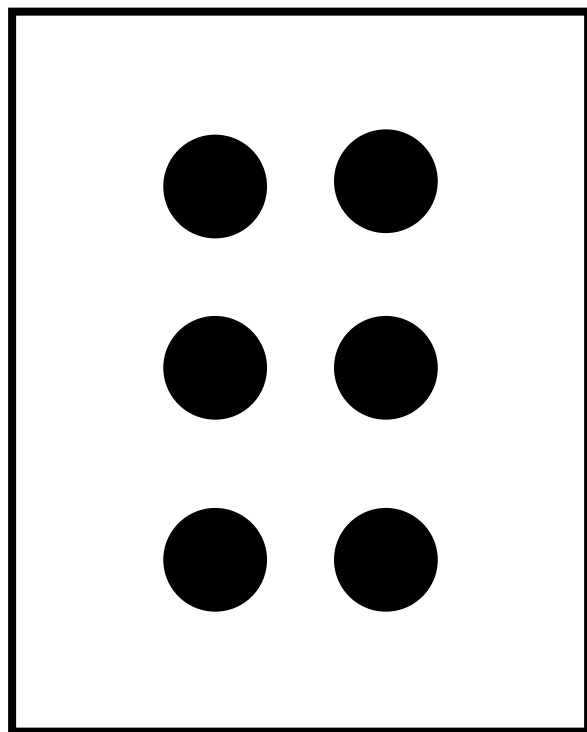
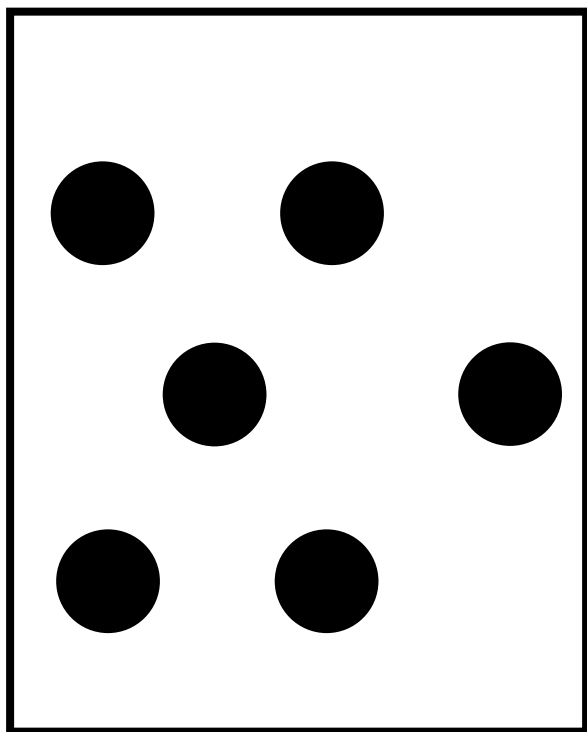

Dot Cards to 20 (continued)

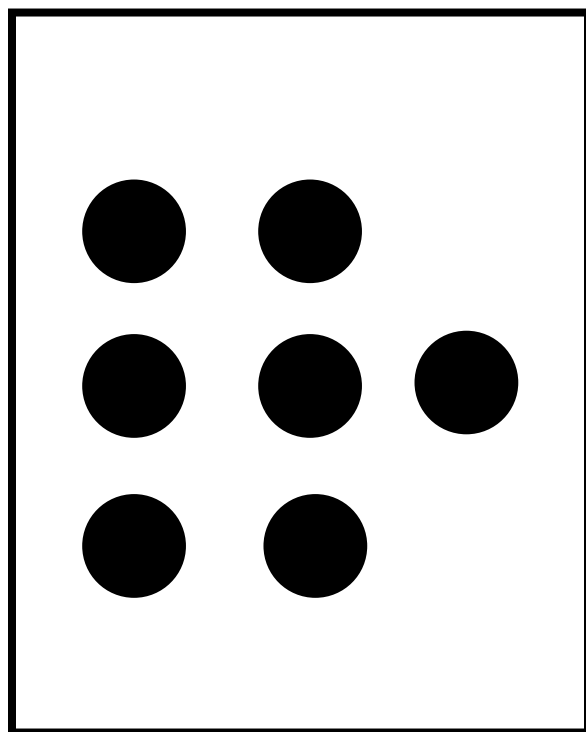
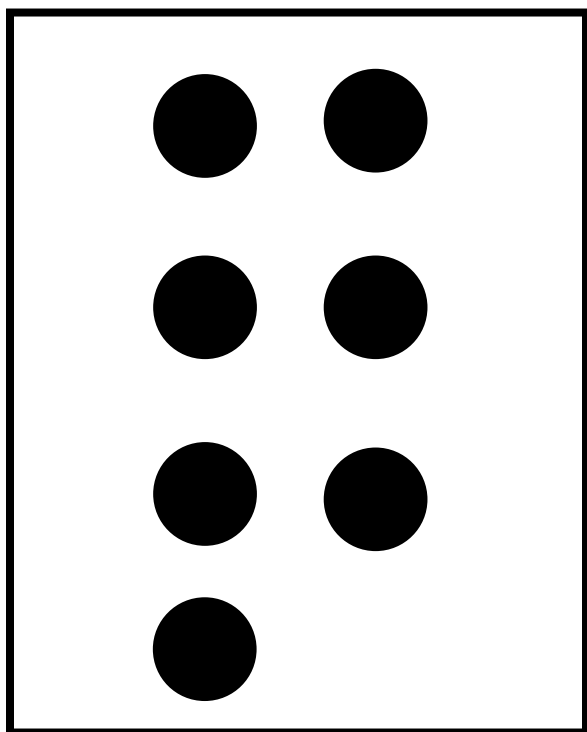
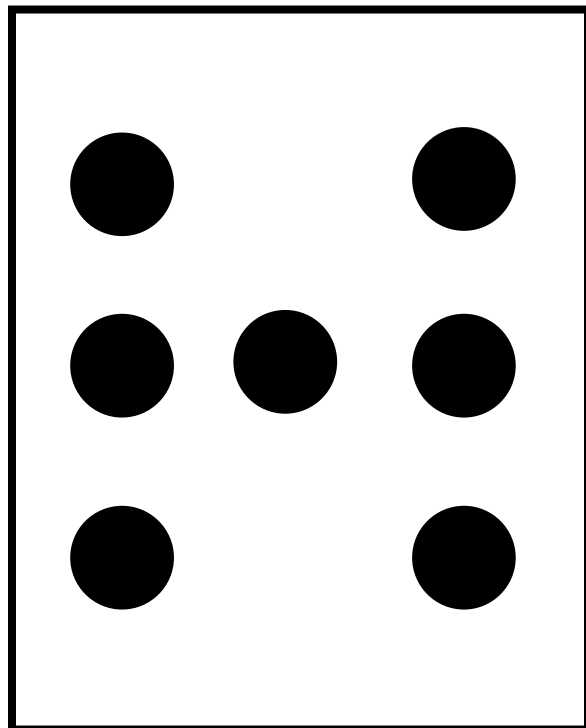
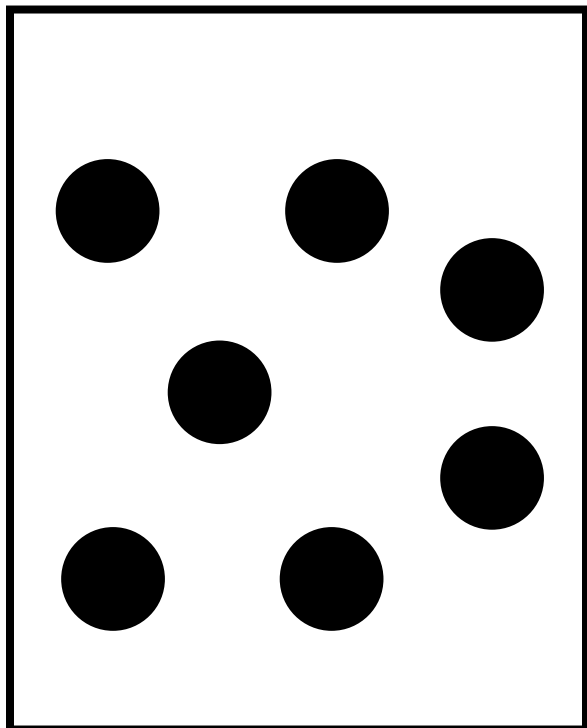

Dot Cards to 20 (continued)

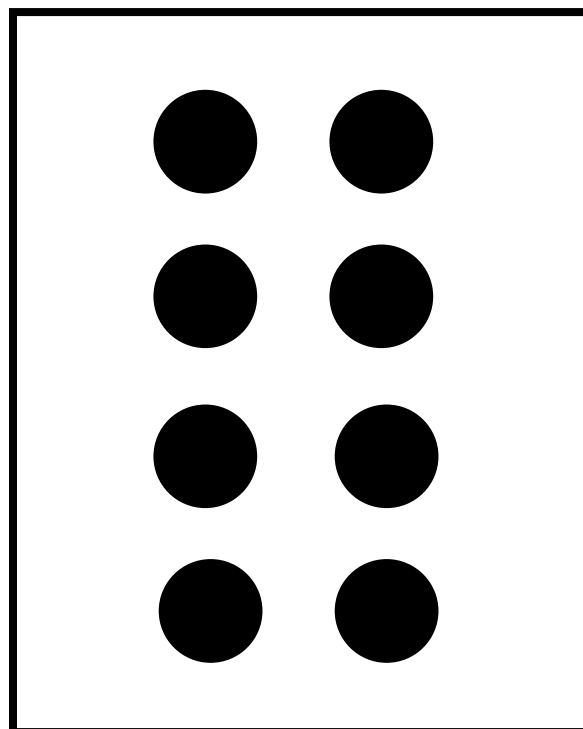
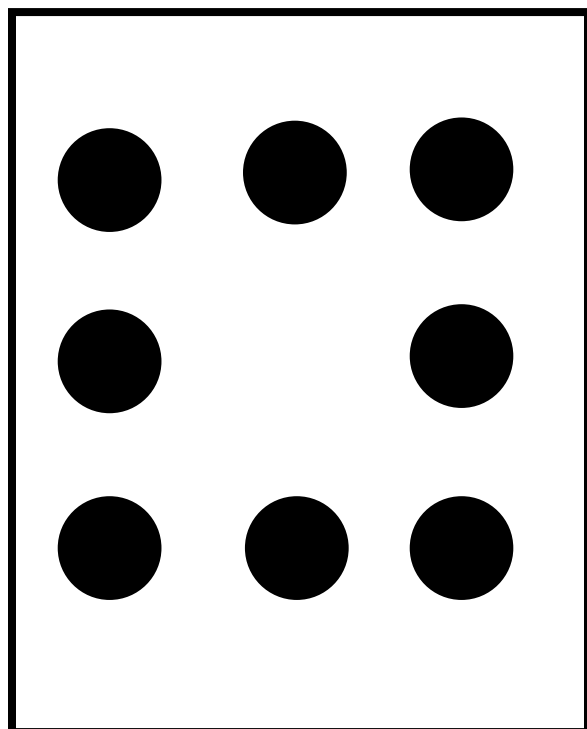
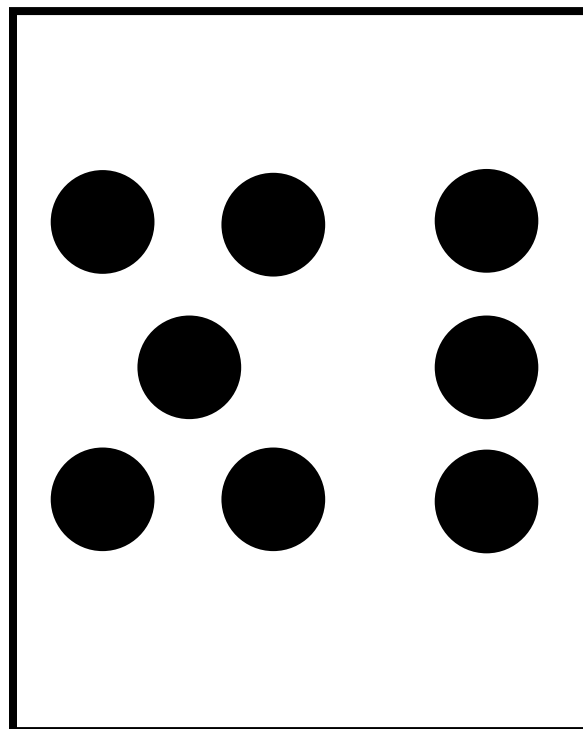
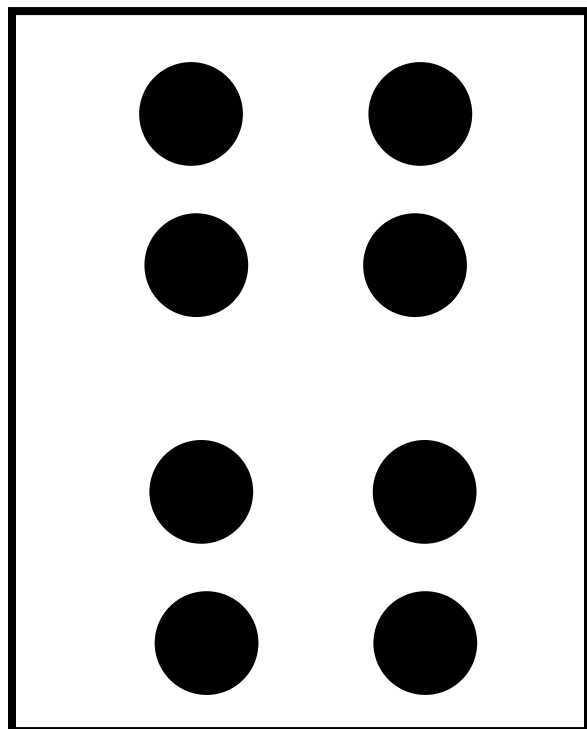

Dot Cards to 20 (continued)

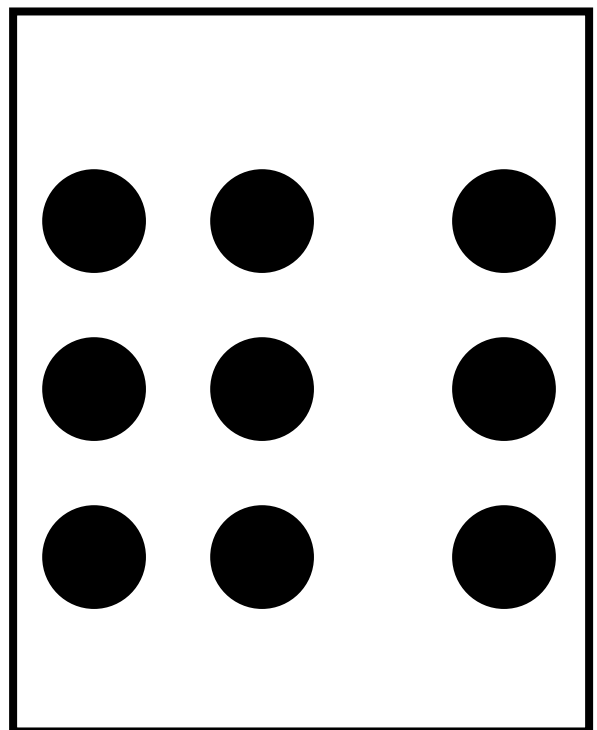
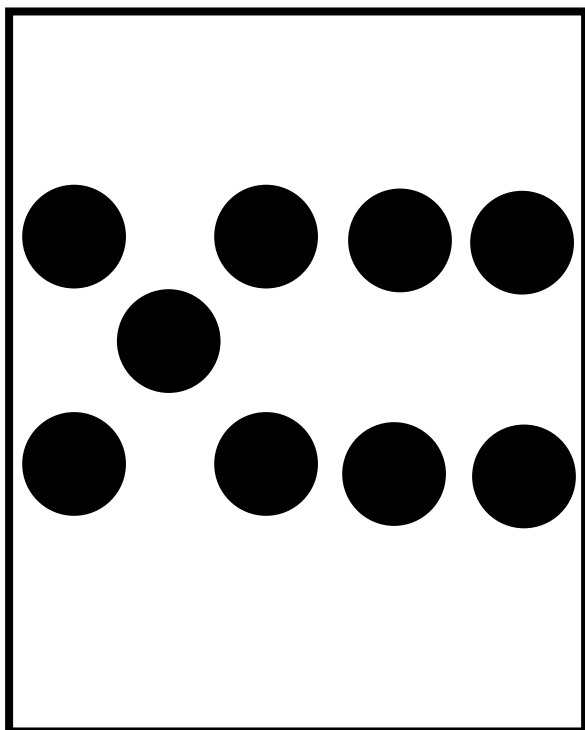
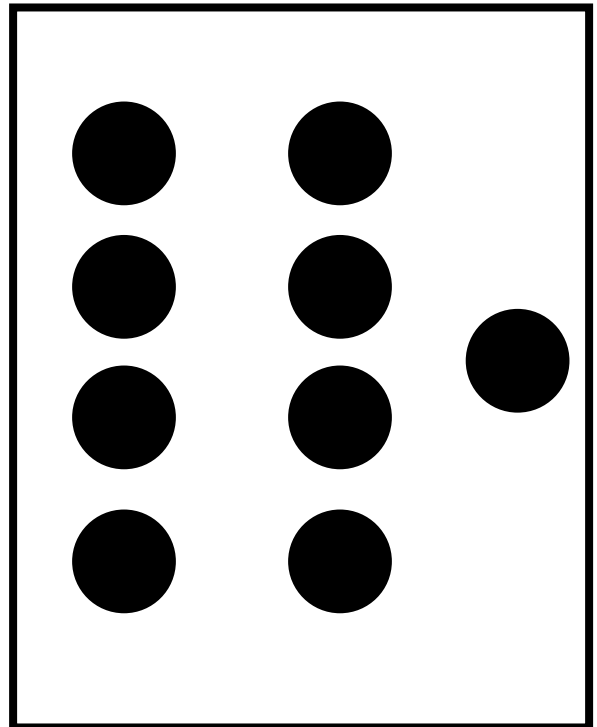
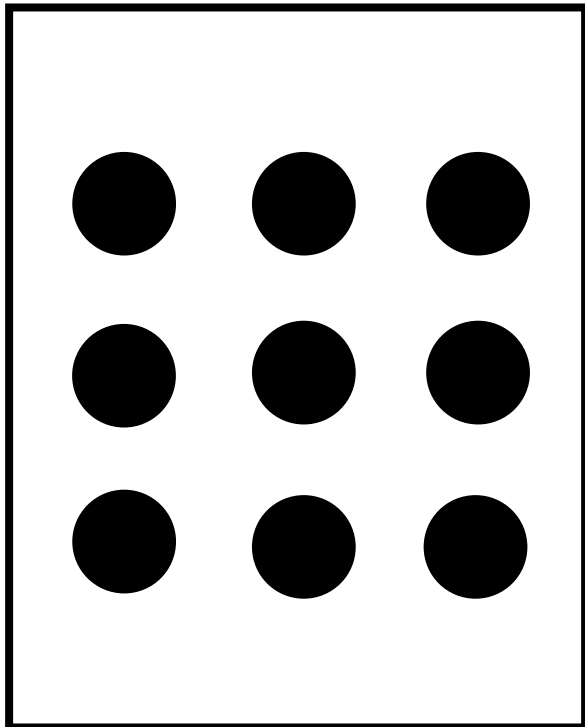

Dot Cards to 20 (continued)

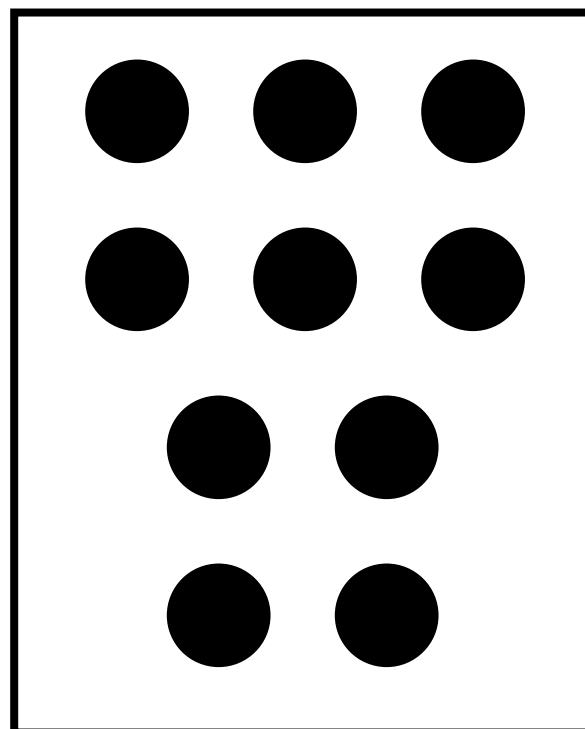
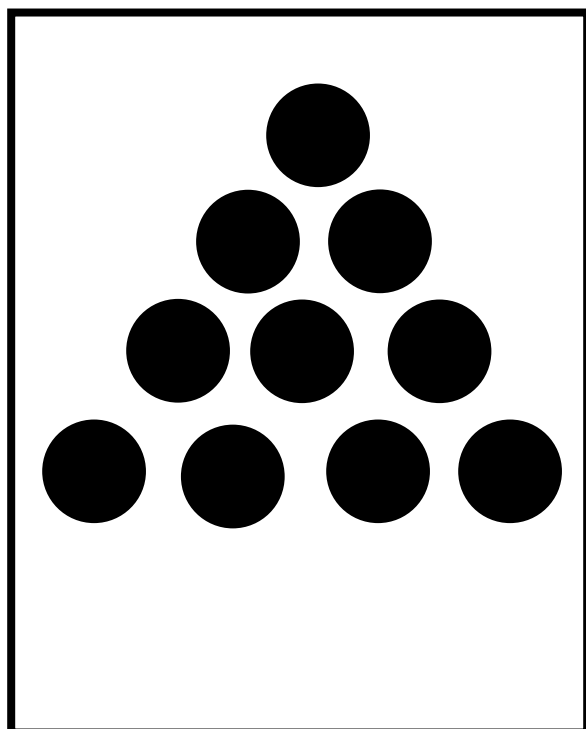
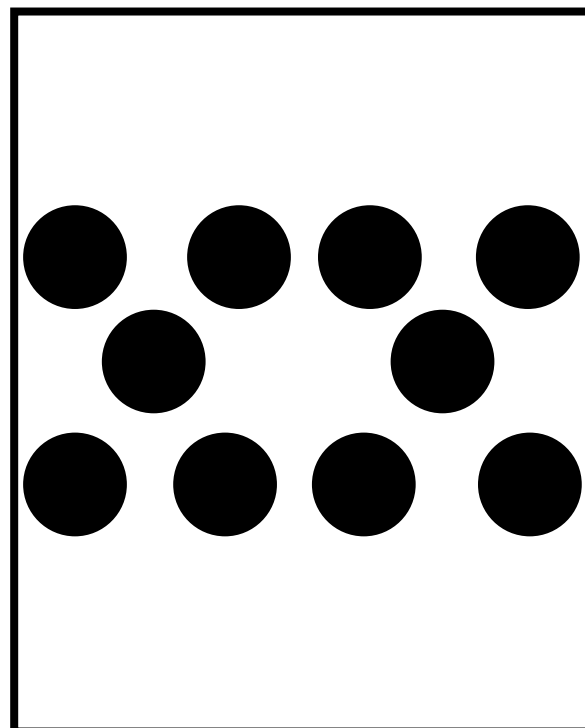
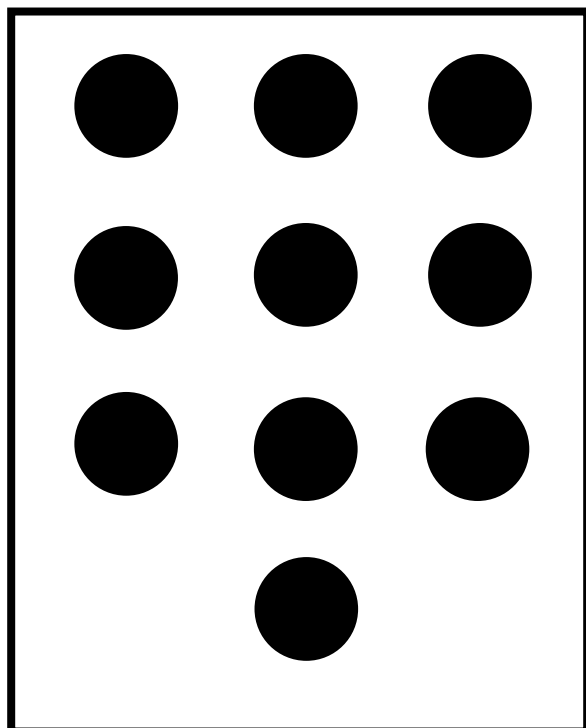

Dot Cards to 20 (continued)

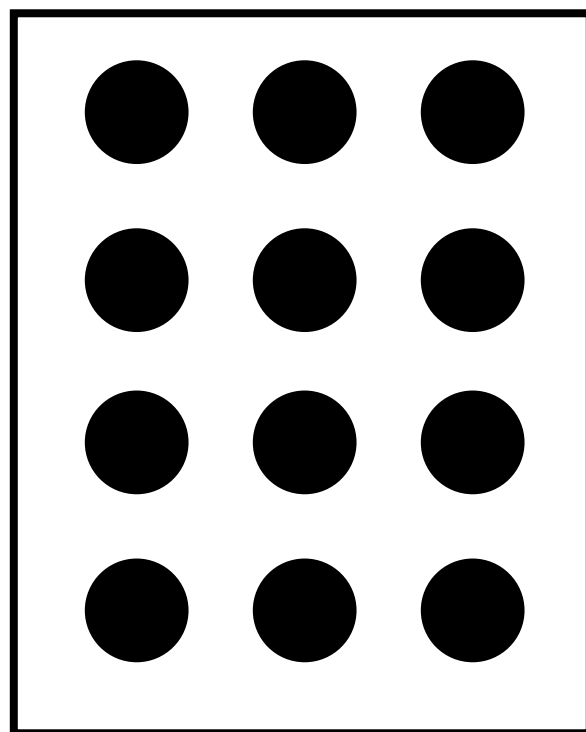
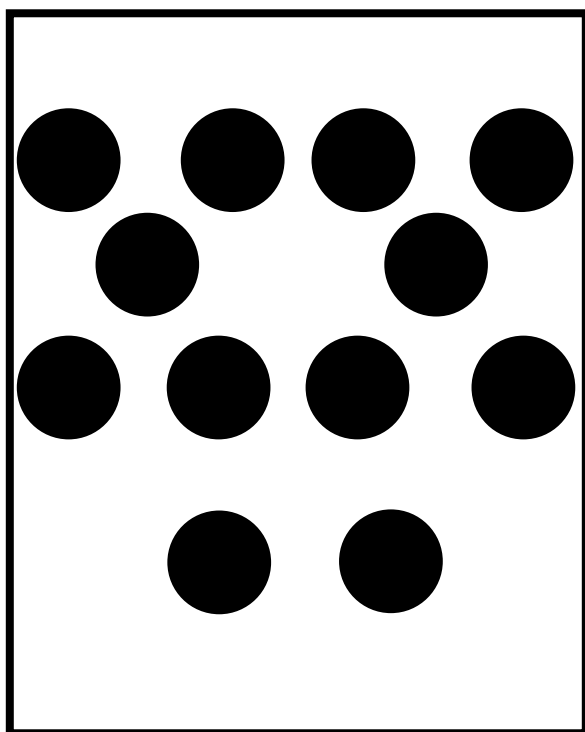
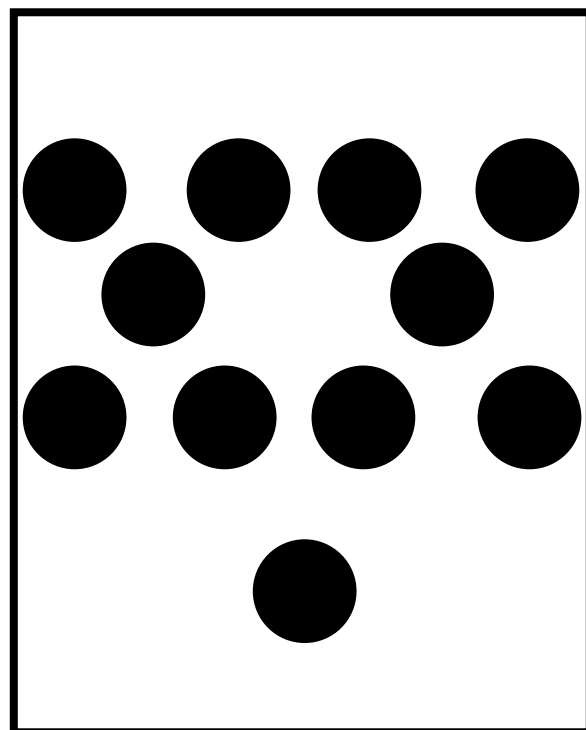
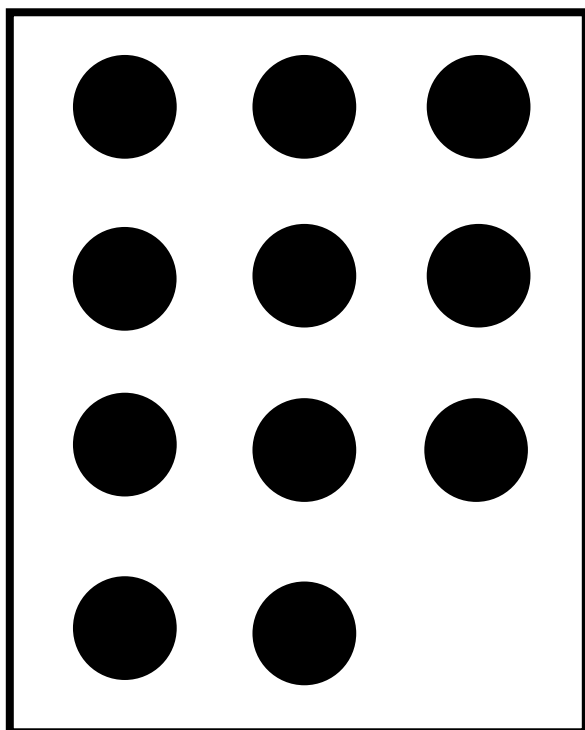

Dot Cards to 20 (continued)

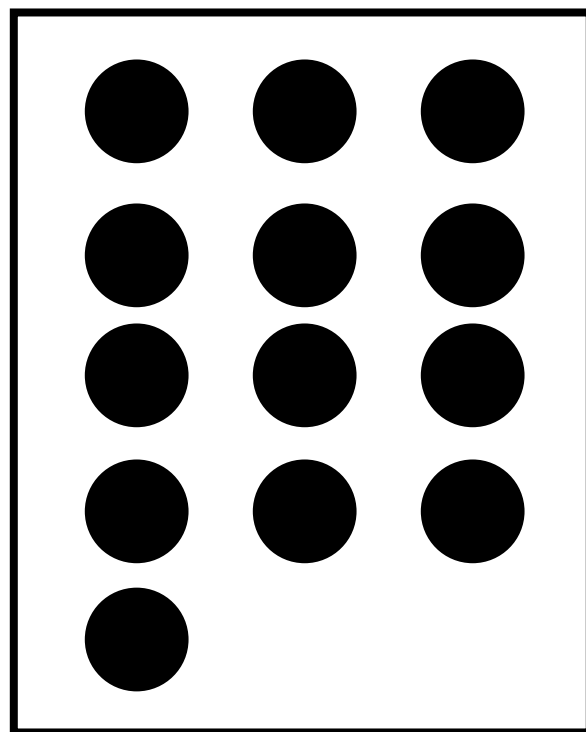
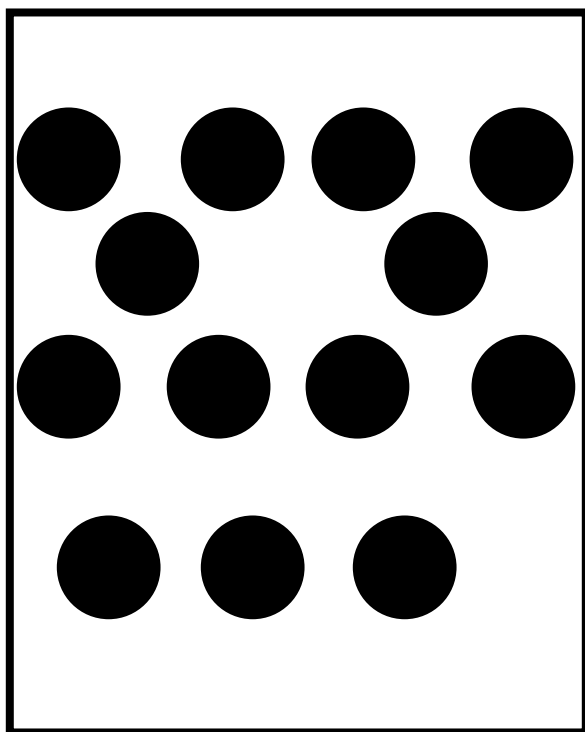
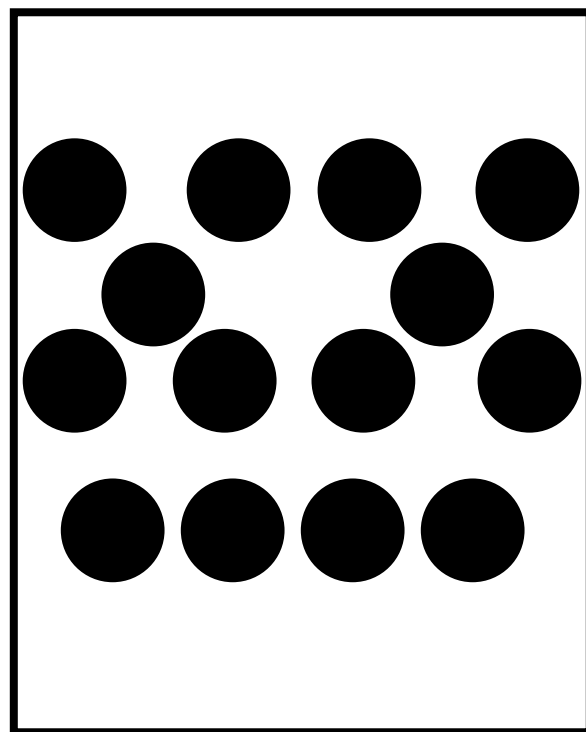
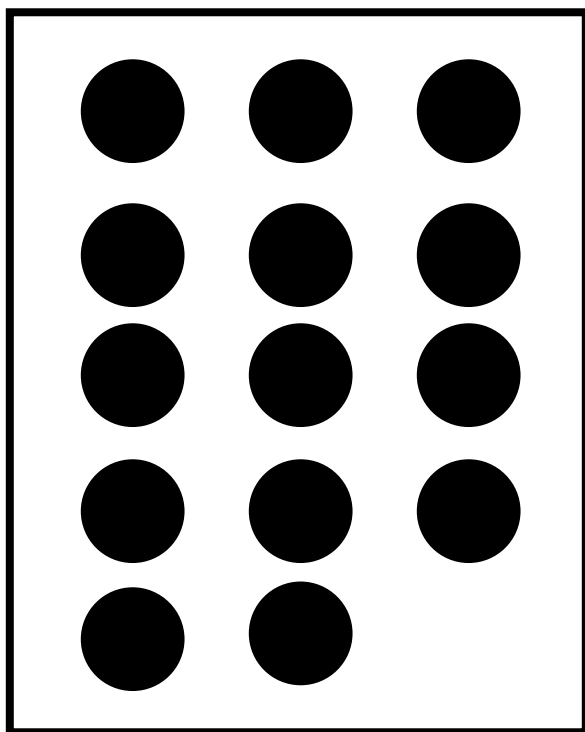

Dot Cards to 20 (continued)

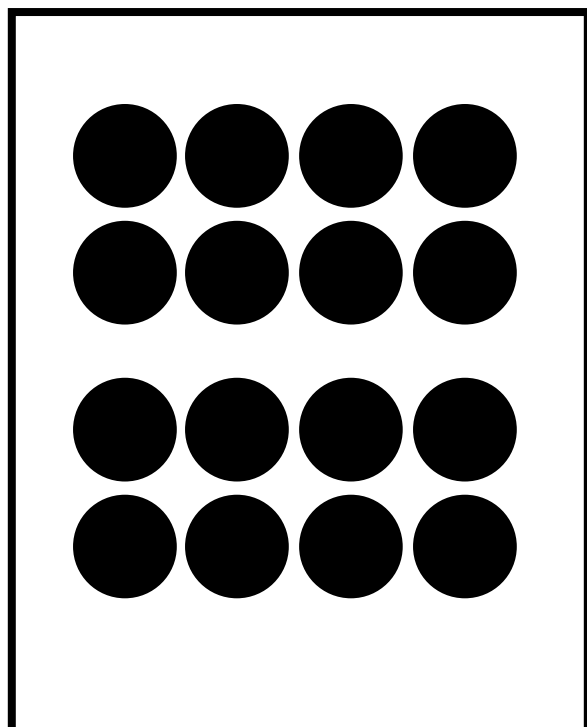
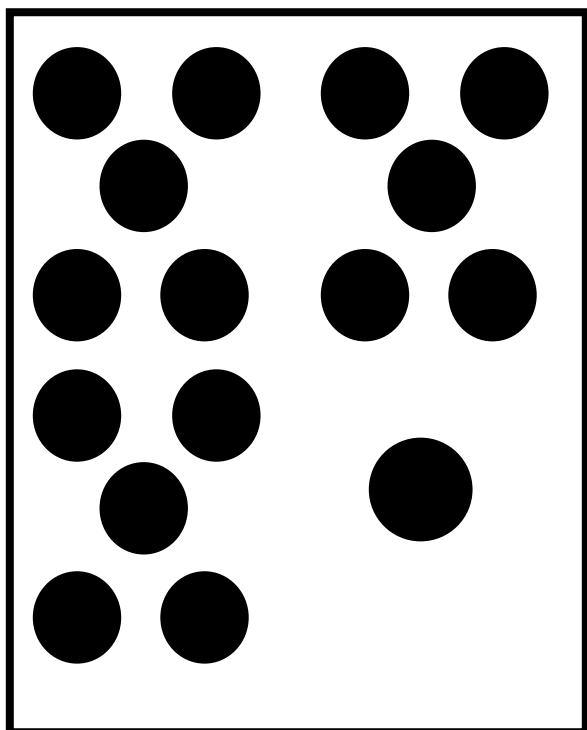
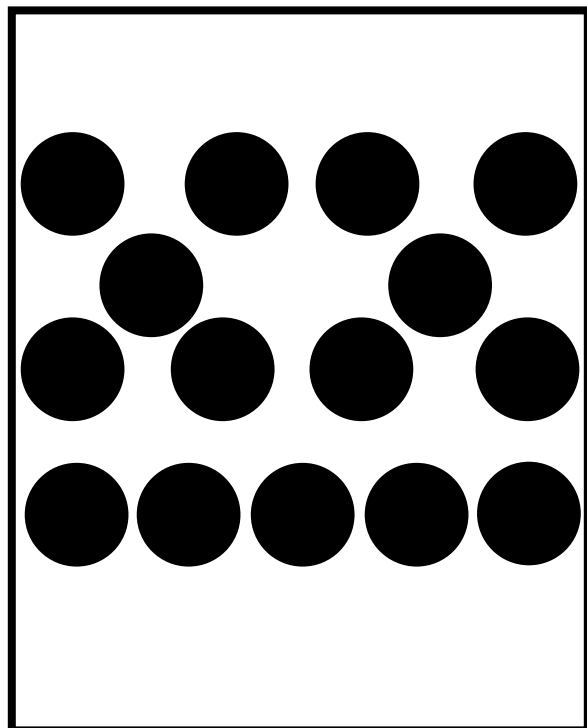
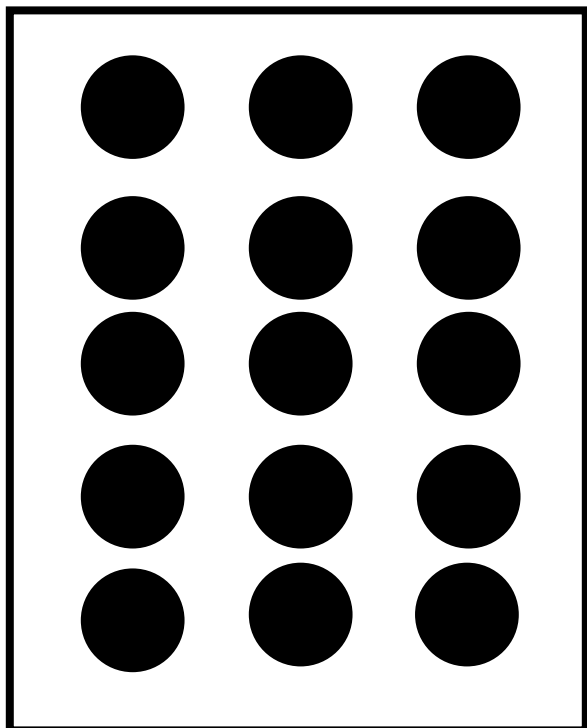

Dot Cards to 20 (continued)

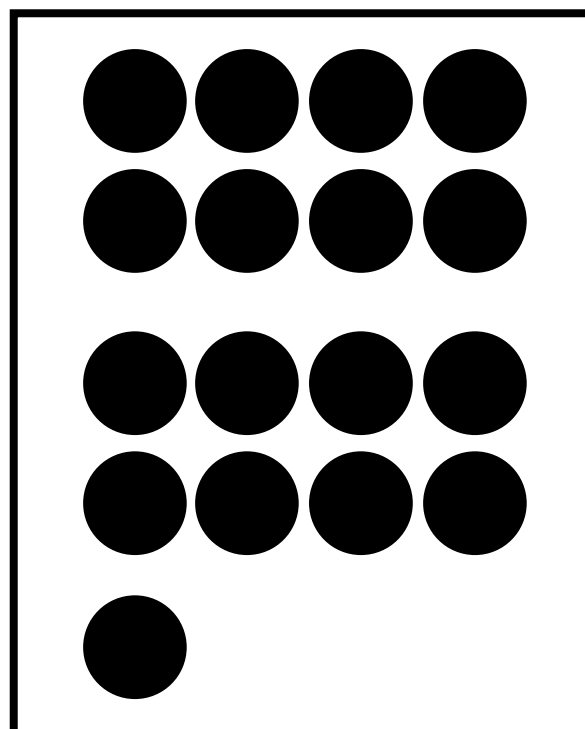
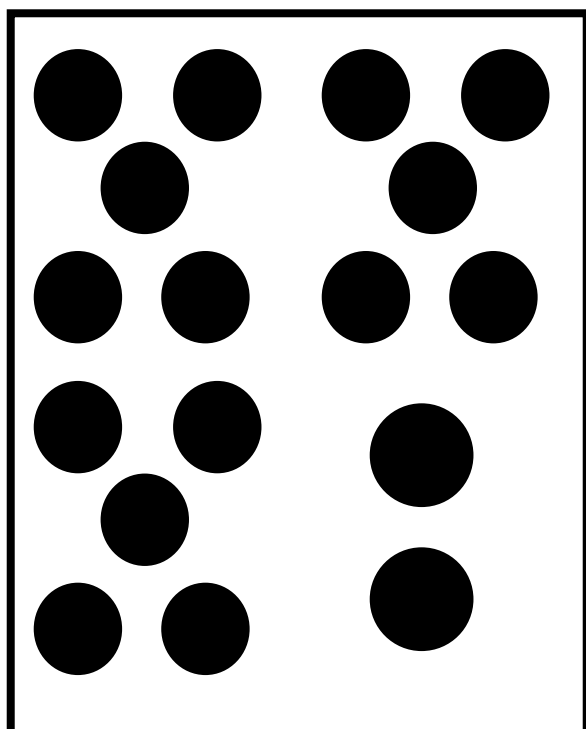
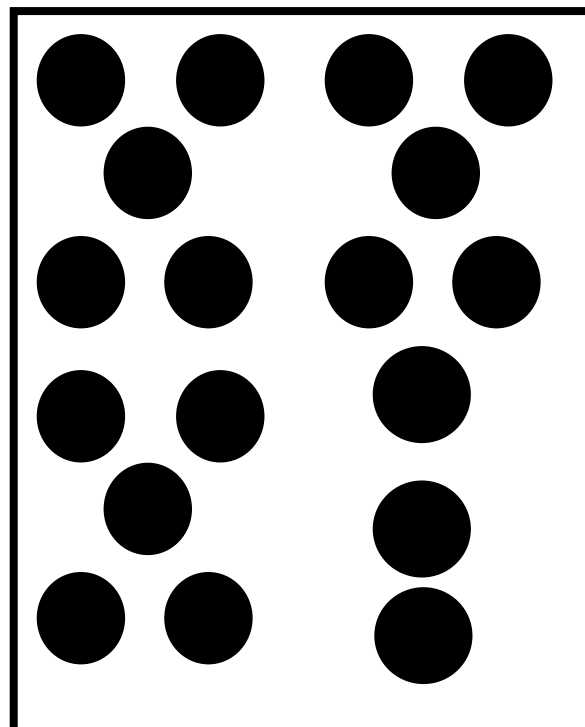
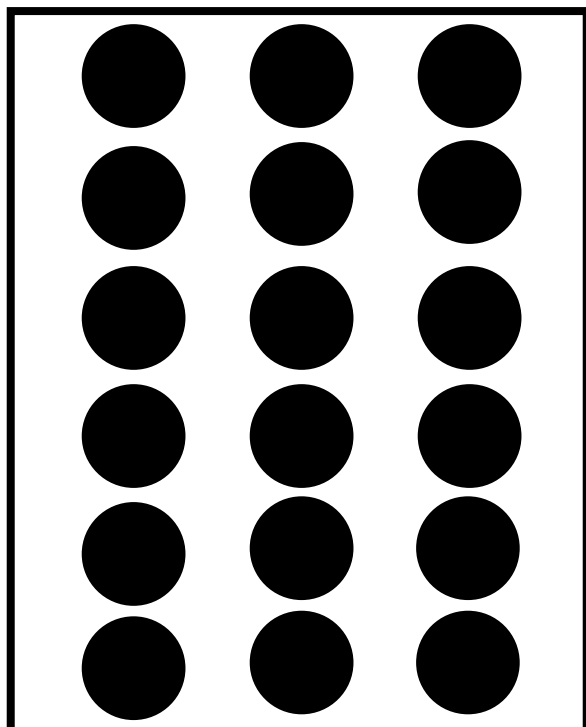

Dot Cards to 20 (continued)

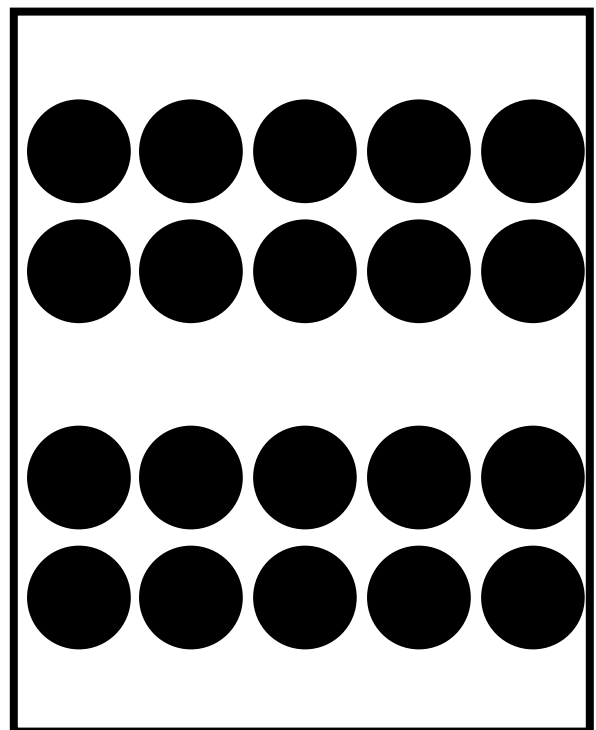
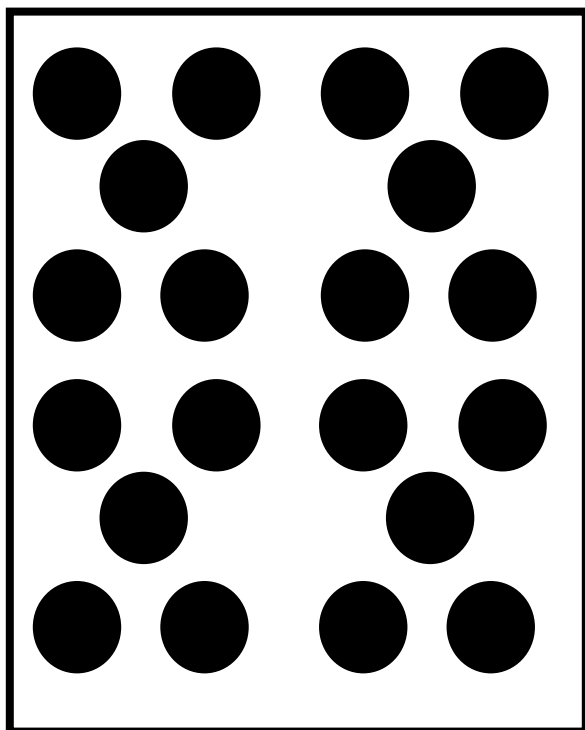
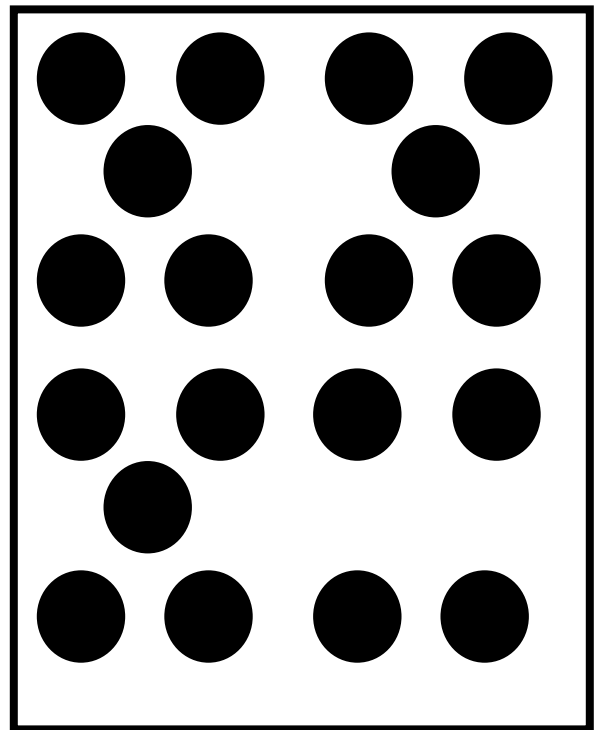
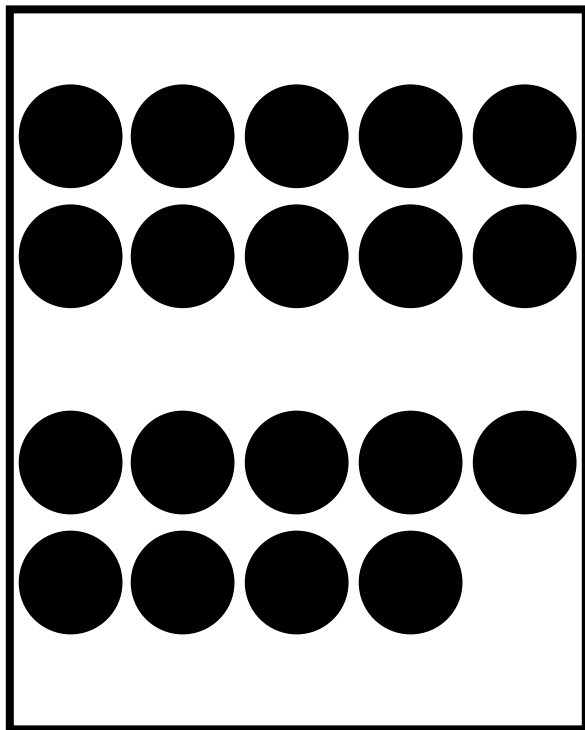

More, Less, or the Same

Note: To make a sample spinner, place the point of the pencil on the centre of a circle, and spin the paper clip around the pencil point.

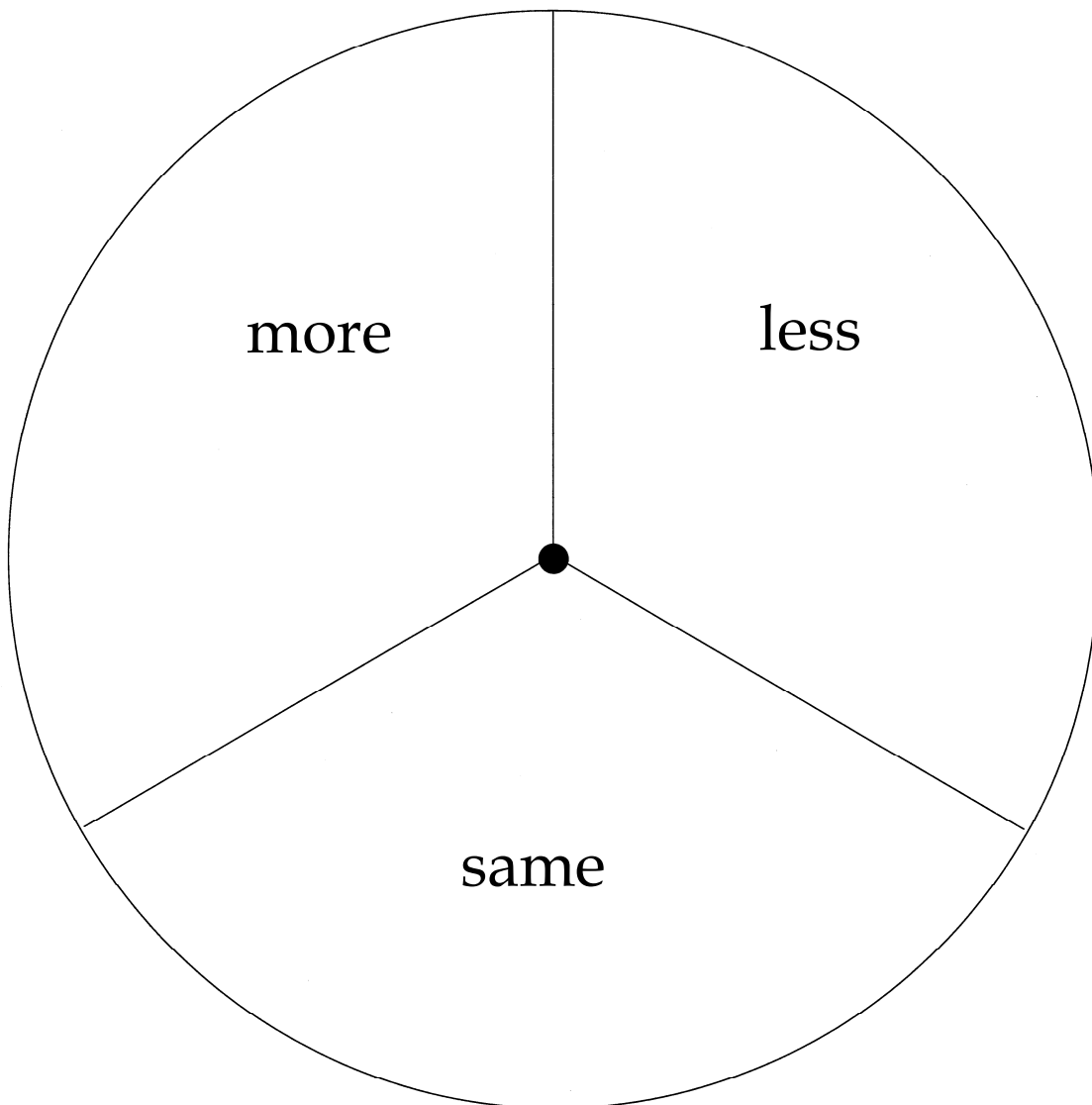

More and Less



There are more _____ than _____ and _____.

There are less _____ than _____ and _____.

Handfuls

Directions:

Take a handful of objects, estimate, and then count the objects. Record your estimate and actual amount below. At the end of the activity, write a goal based on what you have done.

Object	Estimate	Actual	My estimate was: <ul style="list-style-type: none">• too small• just right• too large
My Goal:			

Bucket Pull

Materials: Numeral cards 1 to 20
Spinner or teacher-created die

Directions: Spin the spinner to determine the game rule. Students take turns drawing a numeral card from a bucket or container, apply the rule and say the new number.

Note: To make a sample spinner, place the point of the pencil on the centre of a circle, and spin the paper clip around the pencil point.

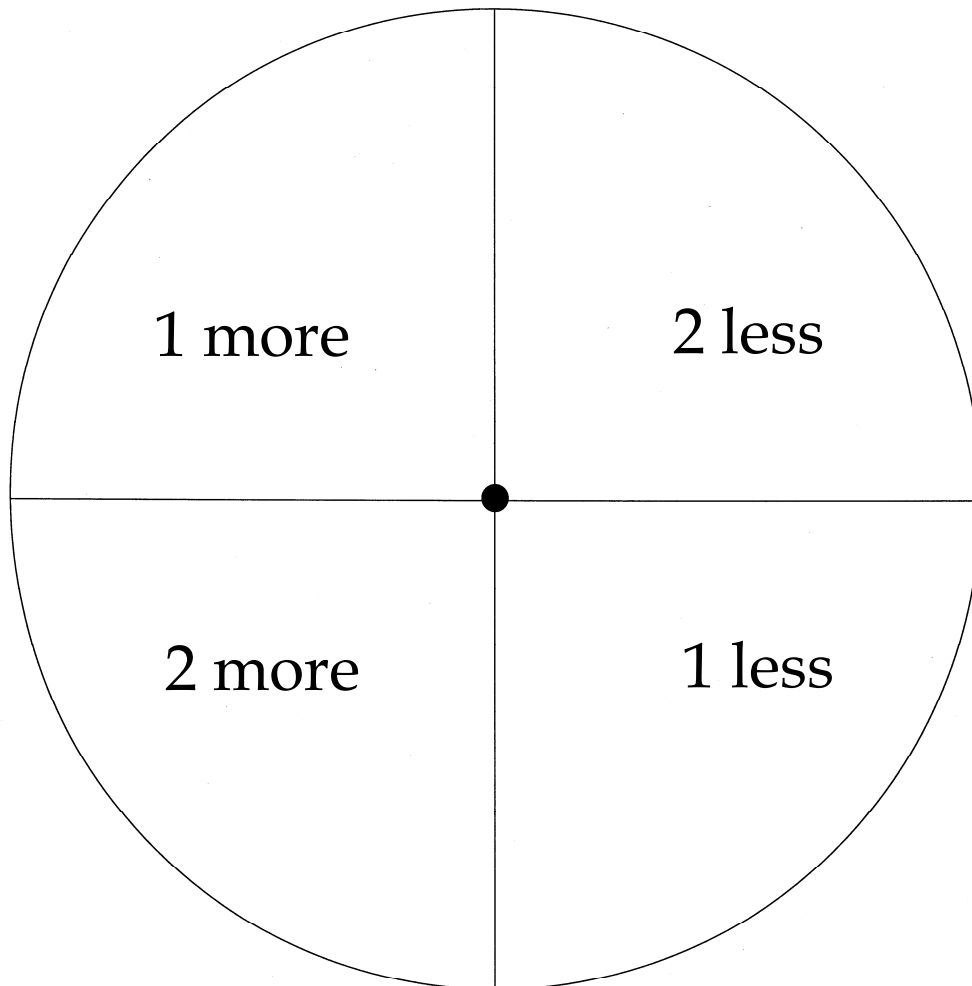

Bucket Pull (continued)

1	2	3	4	5
6	7	8	9	10
11	12	13	14	15
16	17	18	19	20

Double Ten-Frame Board

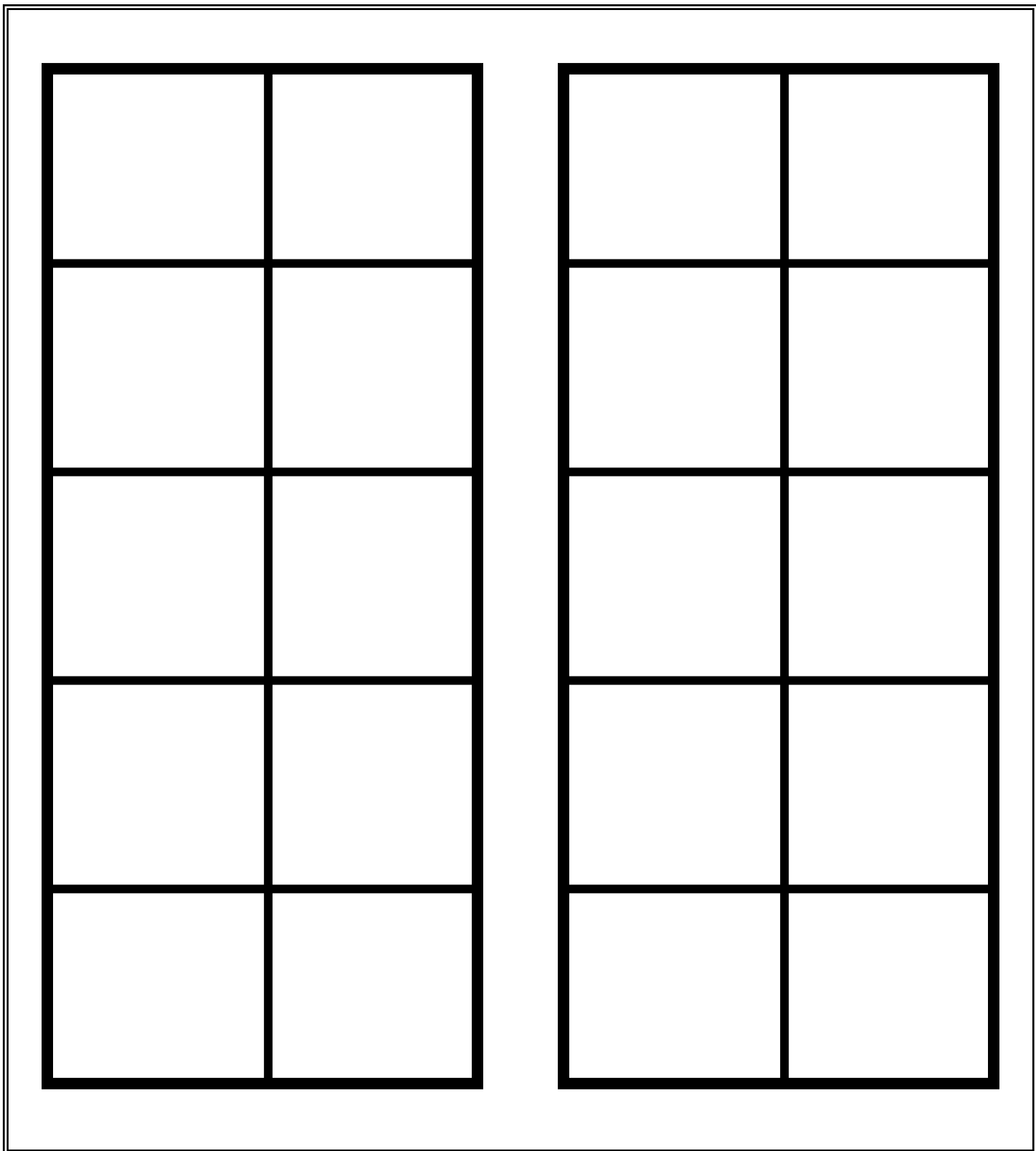

Putting the Pieces Together: I Have... Who Has...

Blank Game Cards

I have

Who has

I have

Who has

I have

Who has

I have

Who has

Putting the Pieces Together: I Have... Who Has... (continued)

Ten-Frame Cards

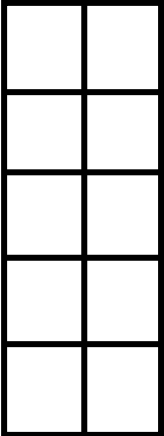
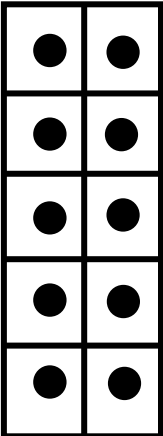
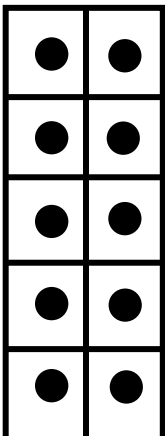
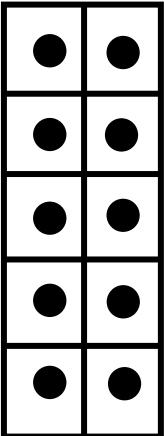
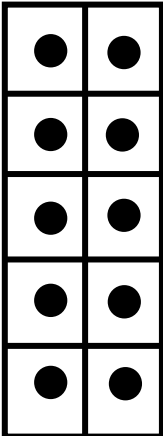
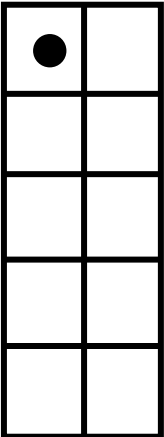
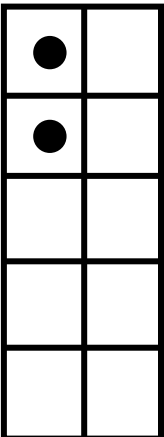
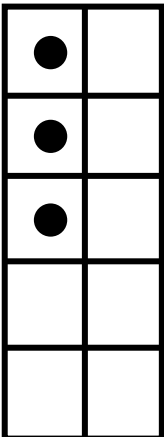
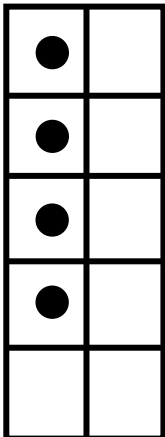
Putting the Pieces Together: I Have... Who Has... (continued)

Ten-Frame Cards

Putting the Pieces Together: I Have... Who Has... (continued)

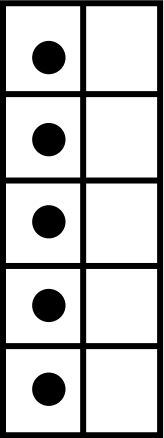
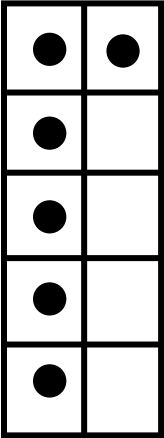
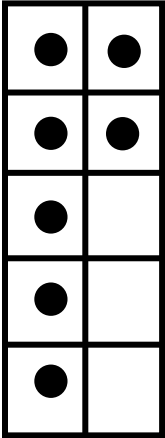
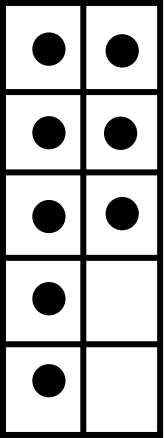
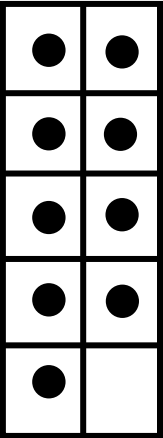
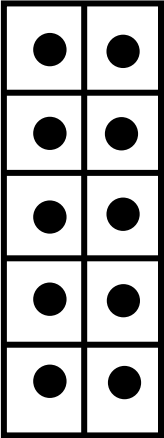
Ten-Frame Cards

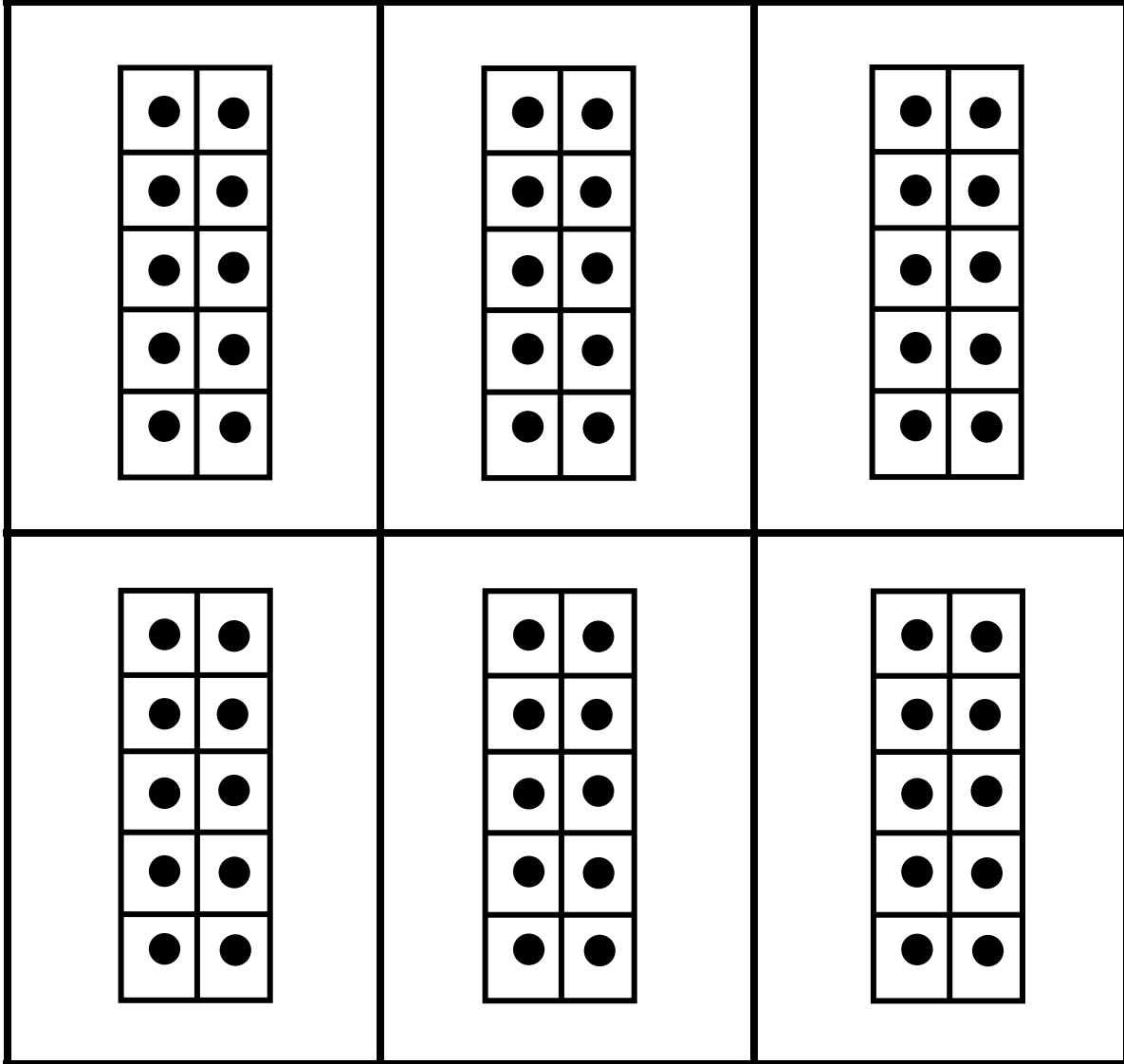

Putting the Pieces Together: I Have... Who Has... (continued)

I have..Who has.. Planning Sheet

I have

Who has

I have

Who has

I have

Who has

I have

Who has

I have

Who has

I have

Who has

I have

Who has

I have

Who has

I have

Who has

Spinner : 1 – 10

Note: To make a sample spinner, place the point of the pencil on the centre of a circle, and spin the paper clip around the pencil point.

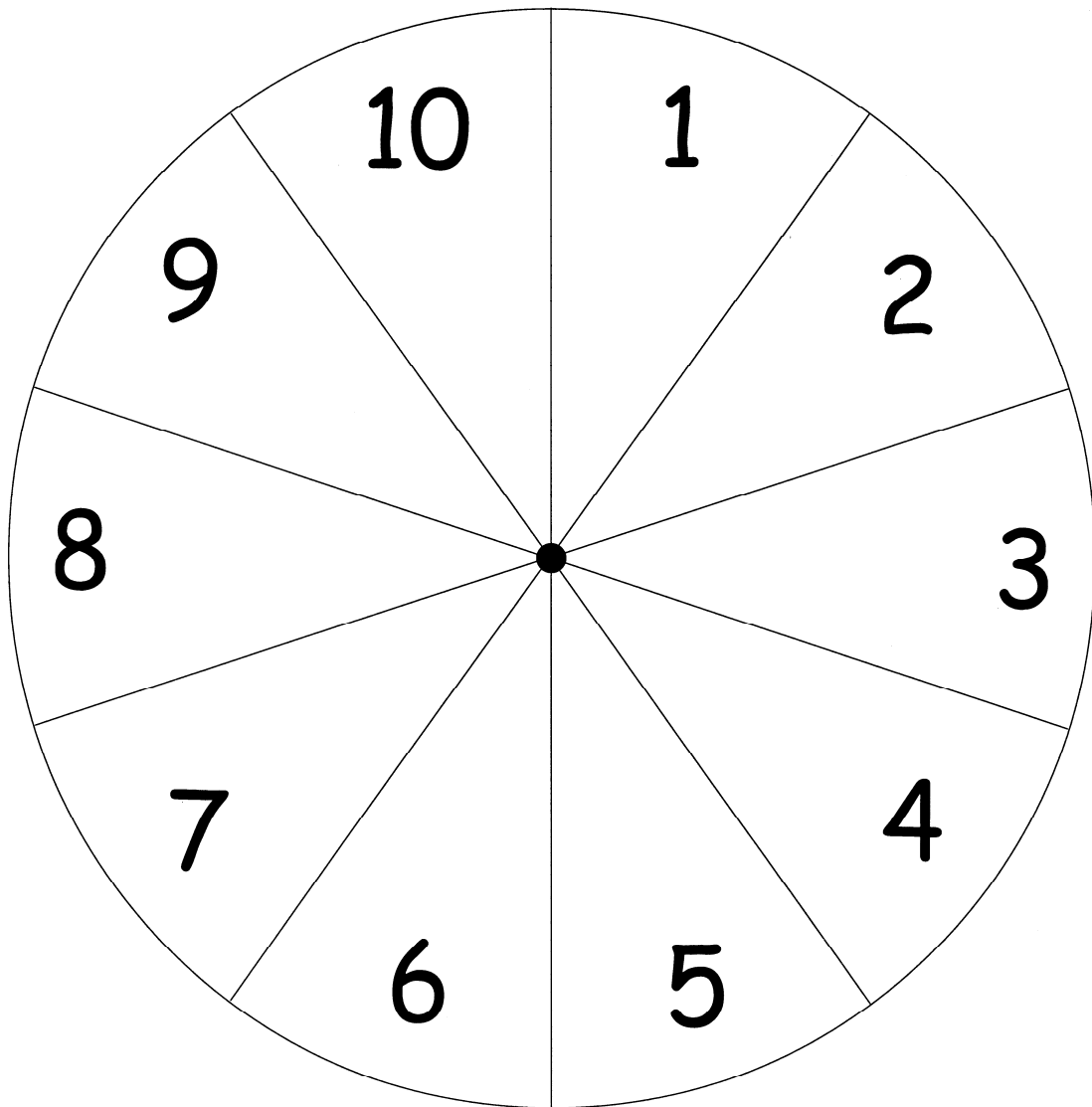

Number Frames

4

--	--	--	--	--

--	--	--	--	--

--	--	--	--	--

--	--	--	--	--

--	--	--	--	--

5

--	--	--	--	--	--	--

--	--	--	--	--	--	--

--	--	--	--	--	--	--

--	--	--	--	--	--	--

--	--	--	--	--	--	--

Number Frames

--	--	--	--	--	--	--	--	--

--	--	--	--	--	--	--	--	--

--	--	--	--	--	--	--	--	--

--	--	--	--	--	--	--	--	--

--	--	--	--	--	--	--	--	--

--	--	--	--	--	--	--	--	--

--	--	--	--	--	--	--	--	--

Number Frames

--	--	--	--	--	--	--	--	--	--

--	--	--	--	--	--	--	--	--	--

--	--	--	--	--	--	--	--	--	--

--	--	--	--	--	--	--	--	--	--

--	--	--	--	--	--	--	--	--	--

--	--	--	--	--	--	--	--	--	--

--	--	--	--	--	--	--	--	--	--

Number Frames

--	--	--	--	--	--	--	--	--	--	--

--	--	--	--	--	--	--	--	--	--	--

--	--	--	--	--	--	--	--	--	--	--

--	--	--	--	--	--	--	--	--	--	--

--	--	--	--	--	--	--	--	--	--	--

--	--	--	--	--	--	--	--	--	--	--

--	--	--	--	--	--	--	--	--	--	--

10

Triangular Flashcards

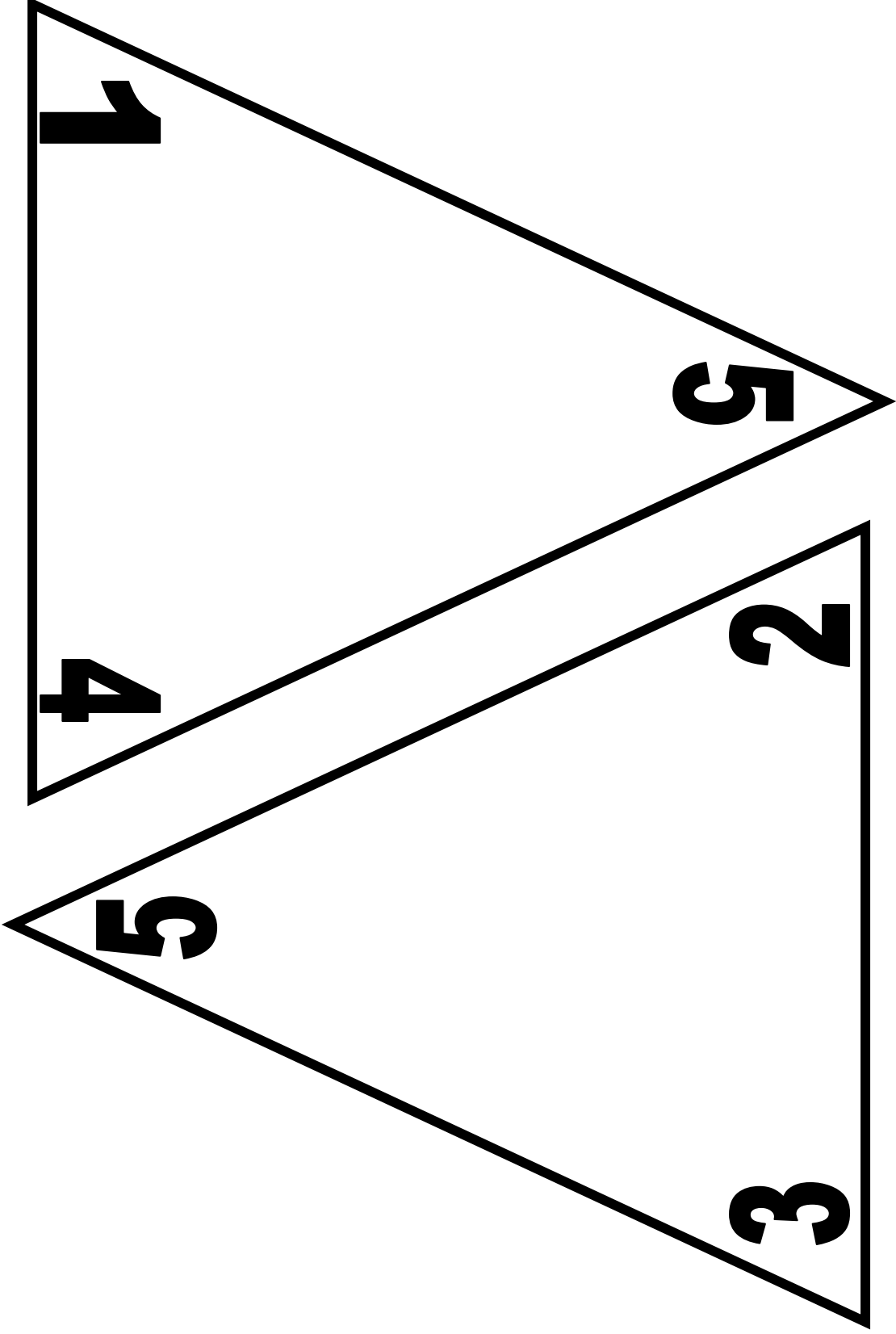

Triangular Flashcards (continued)

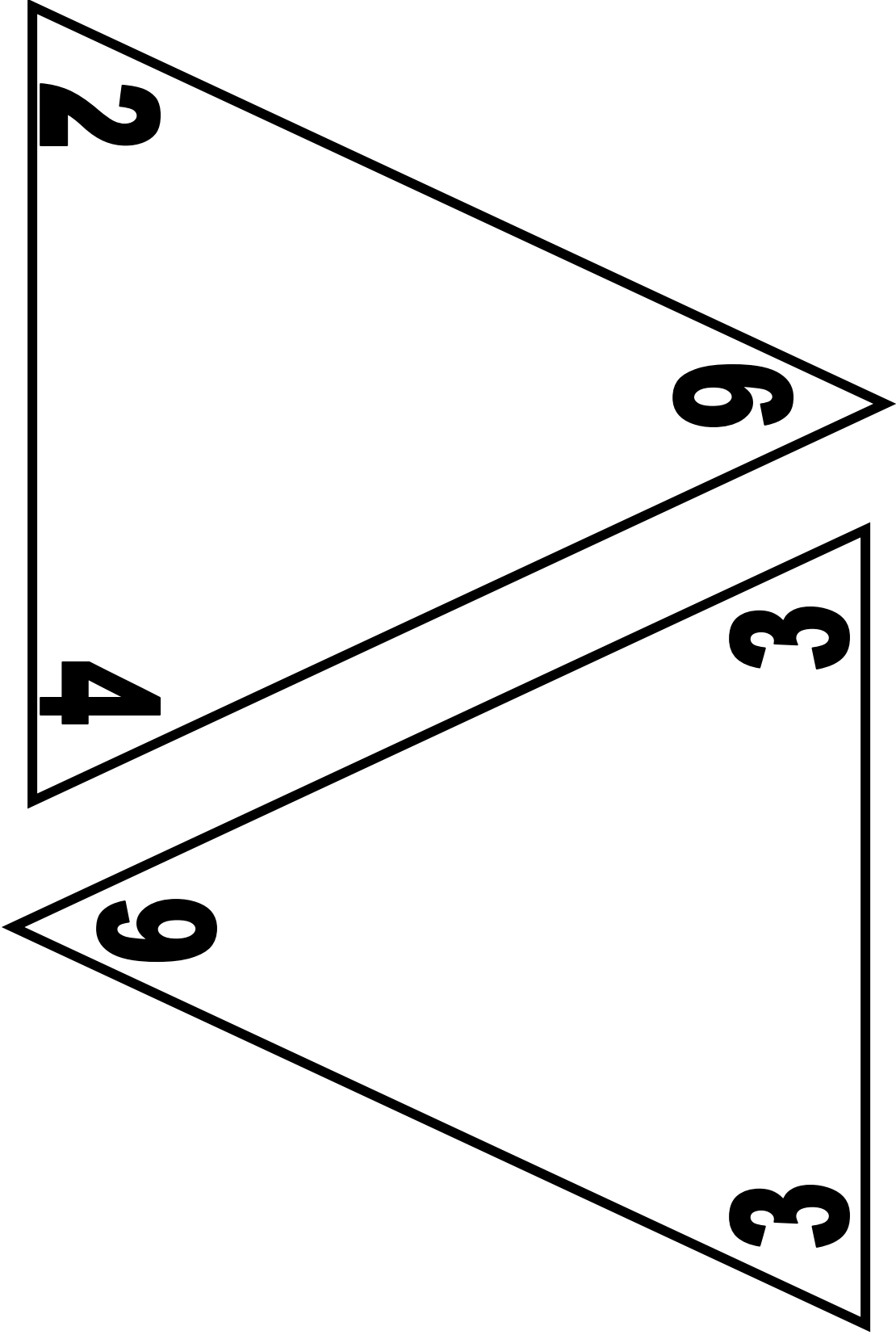

Triangular Flashcards (continued)

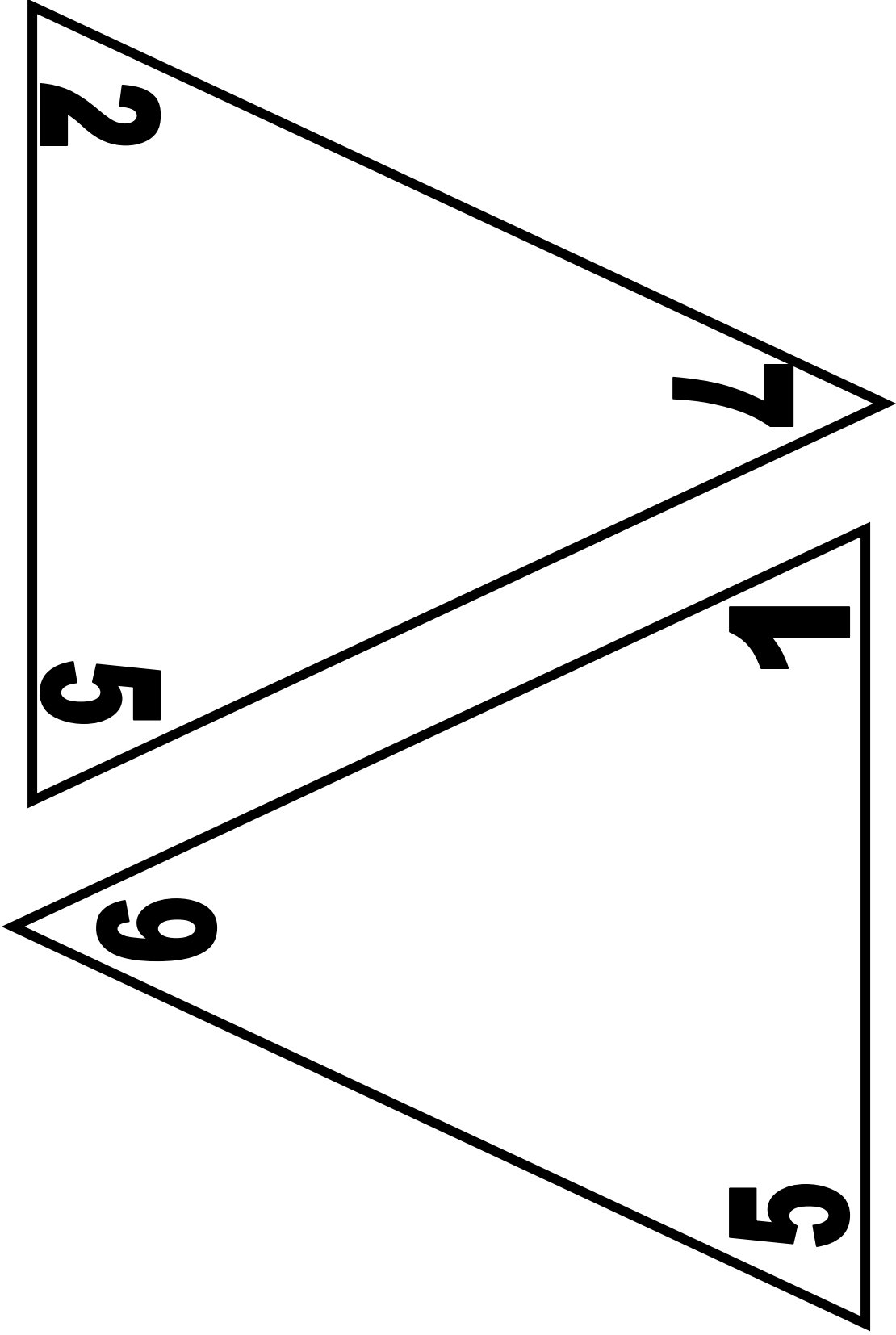

Triangular Flashcards (continued)

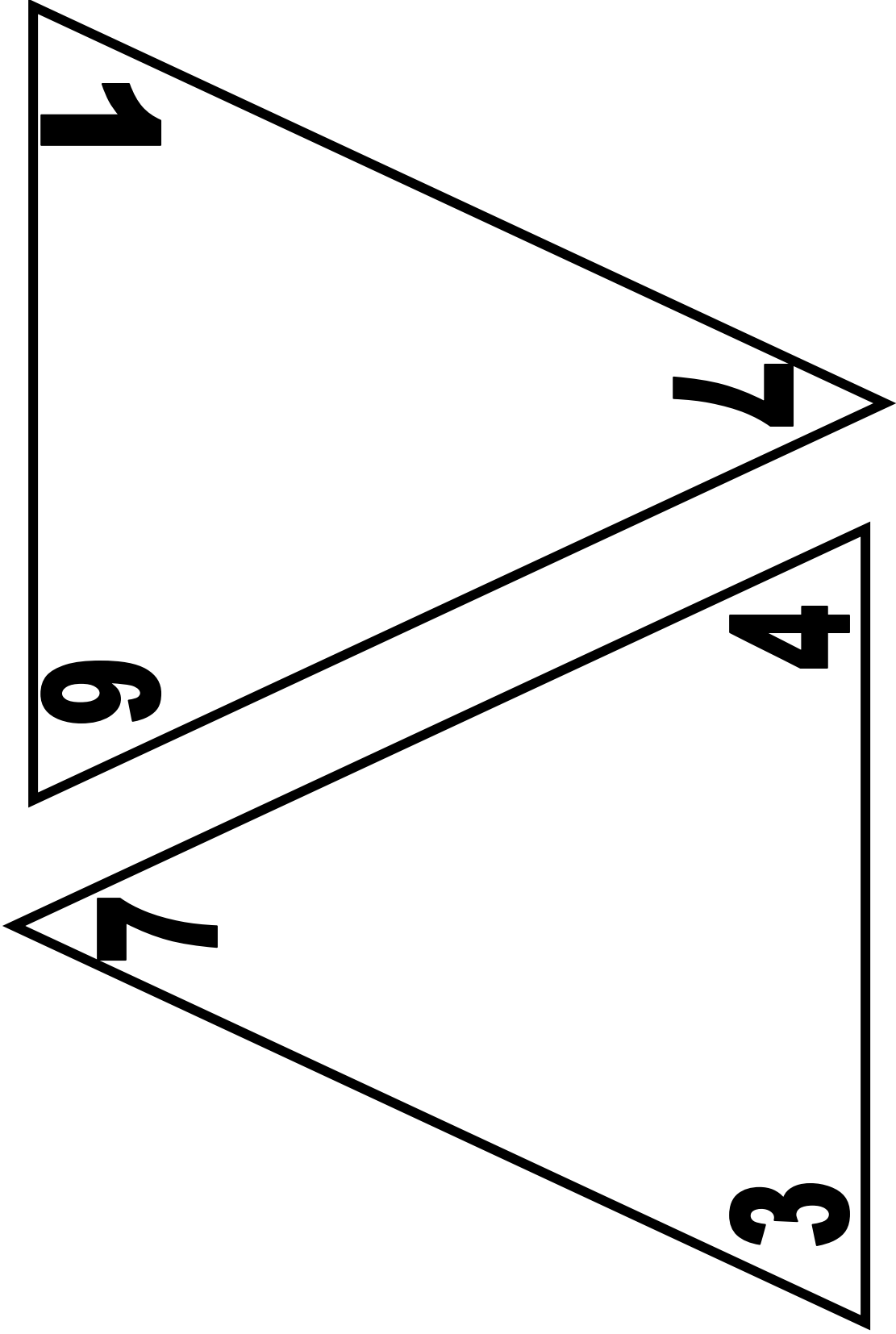

Triangular Flashcards (continued)

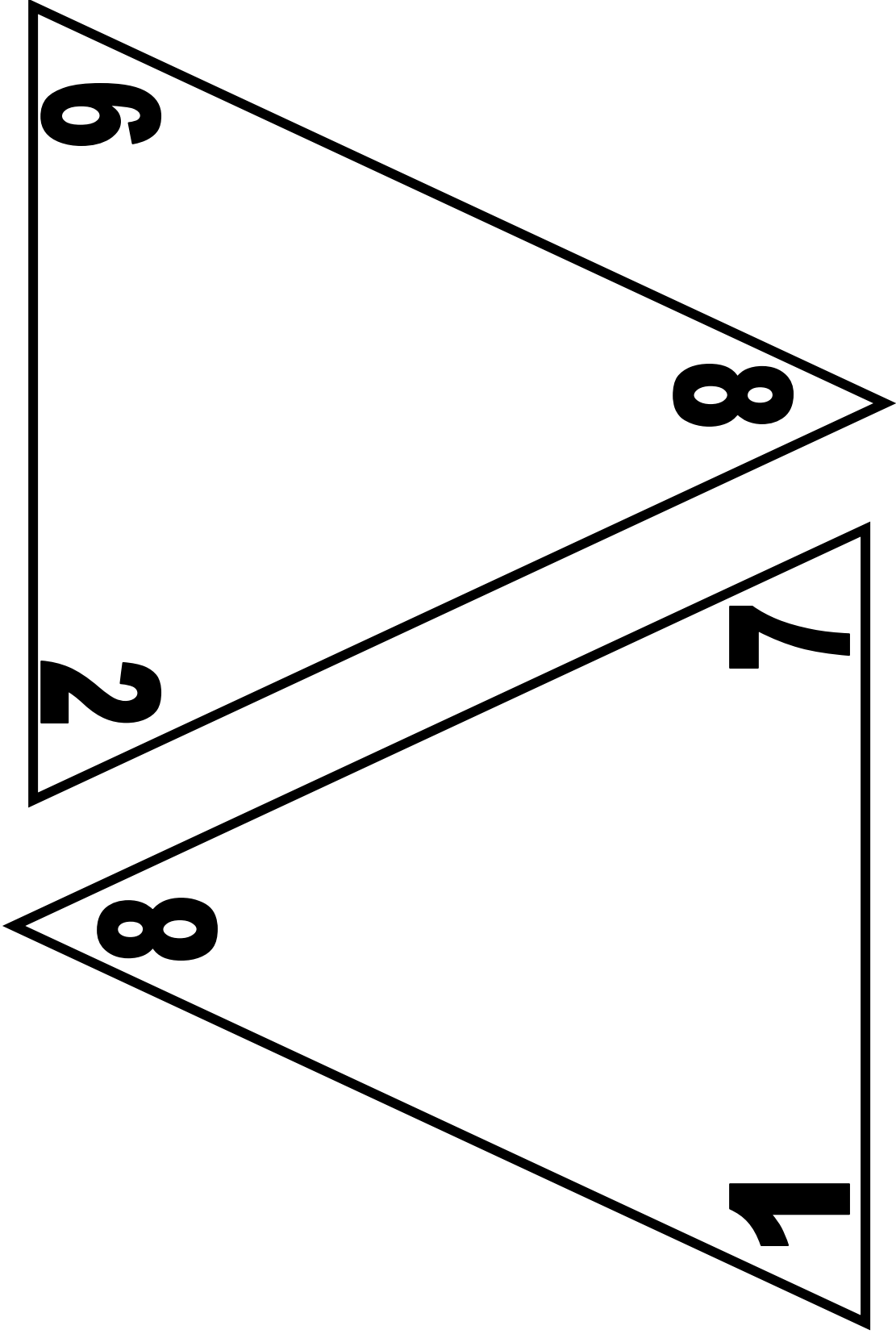

Triangular Flashcards (continued)

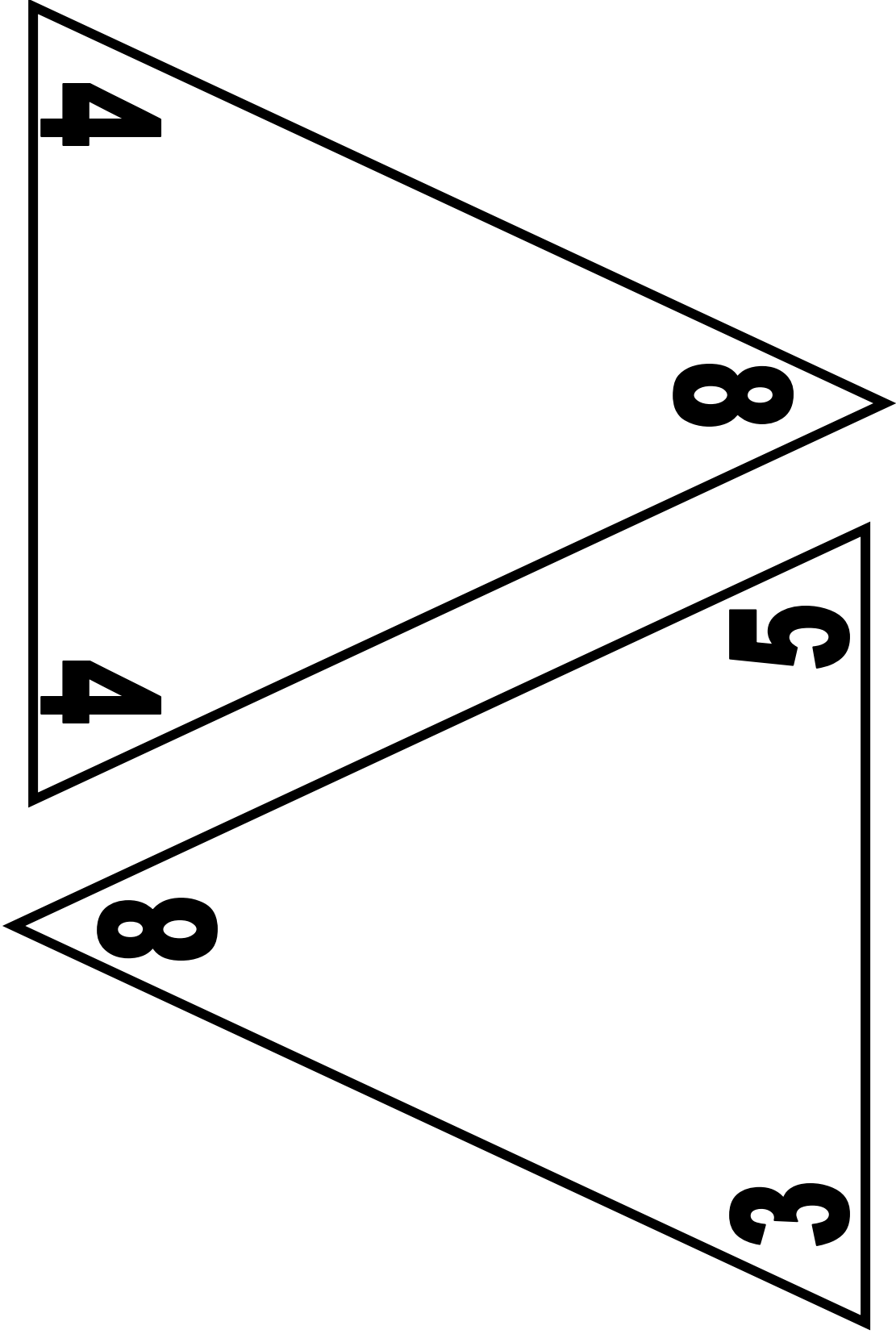

Triangular Flashcards (continued)

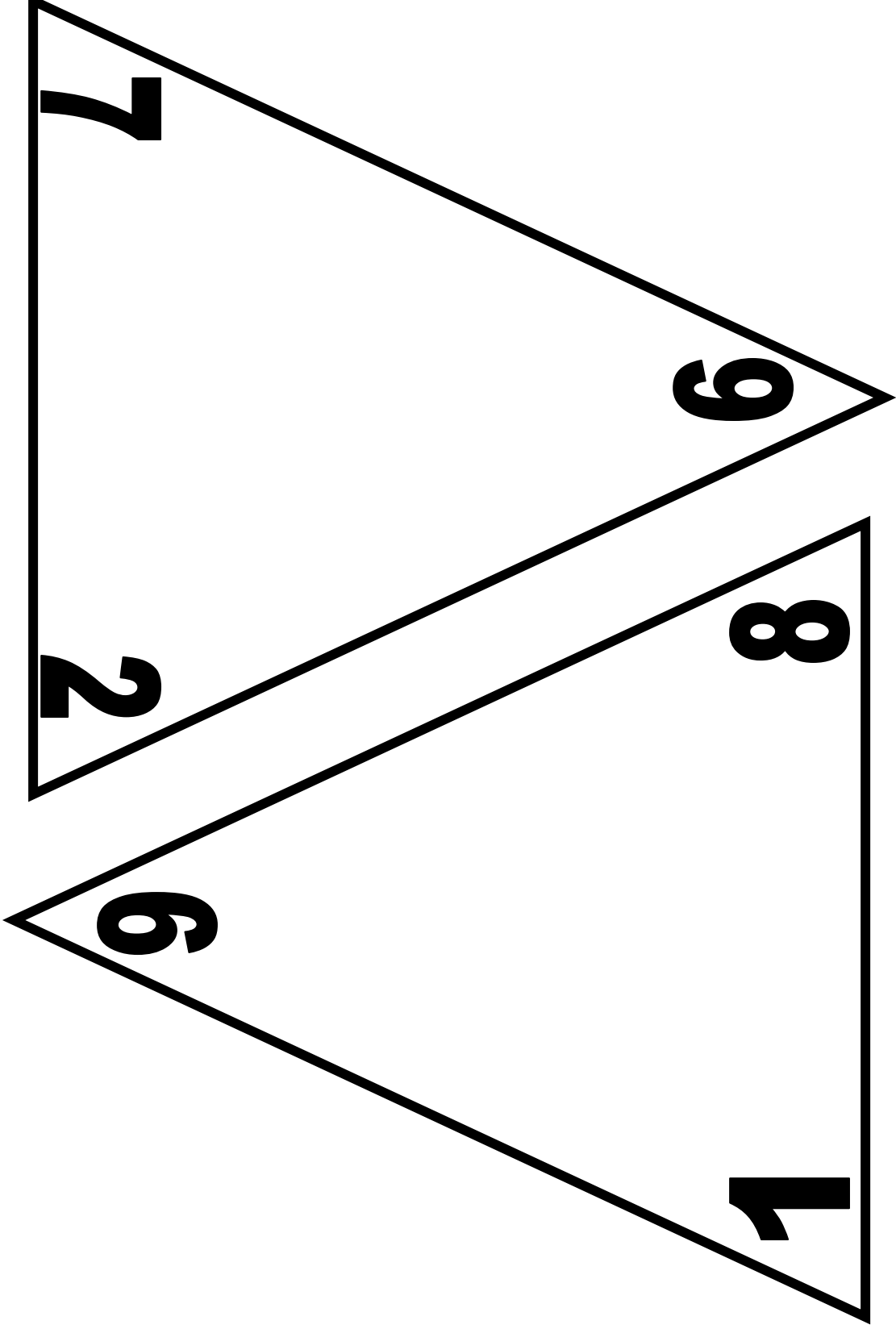

Triangular Flashcards (continued)

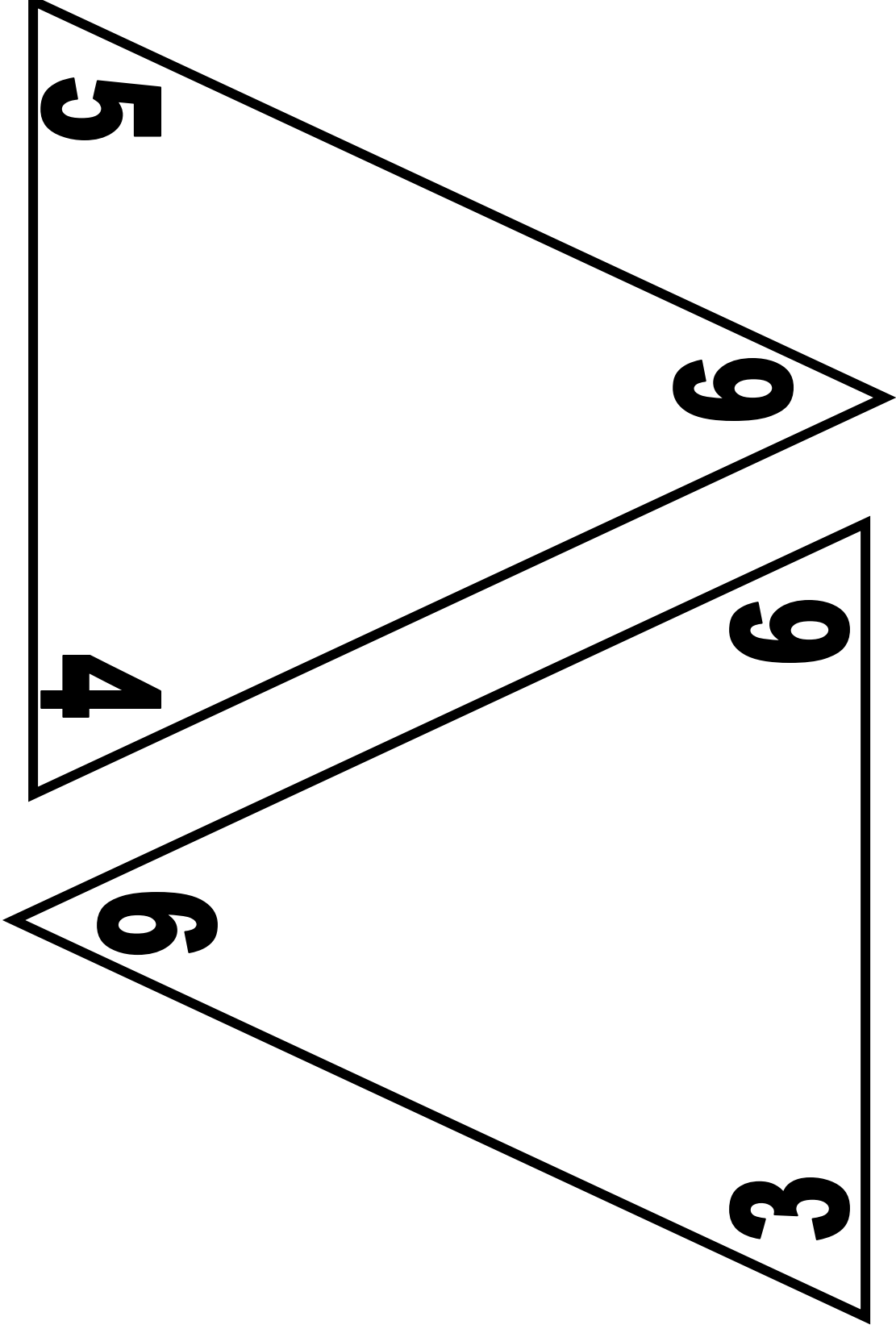

Triangular Flashcards (continued)

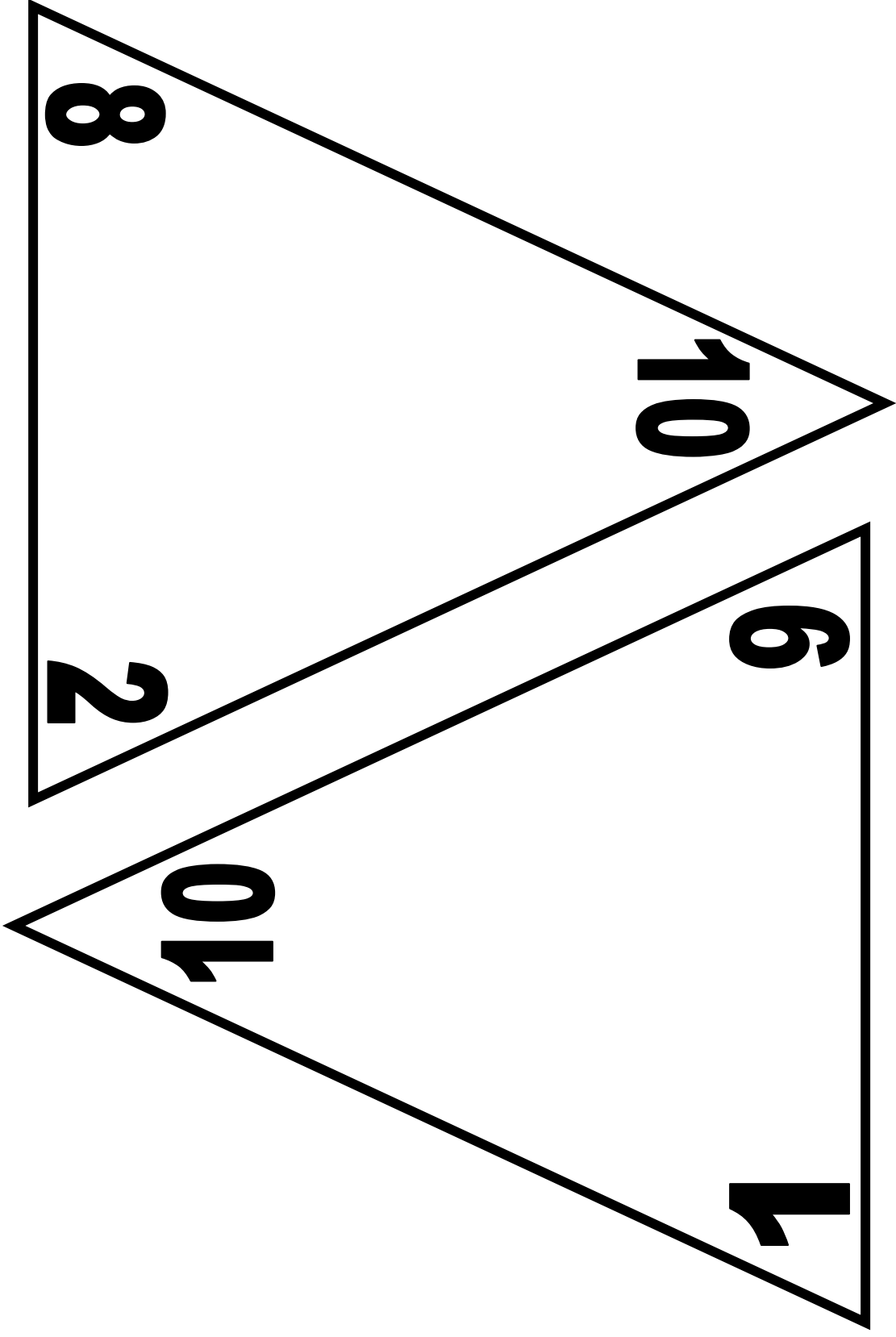

Triangular Flashcards (continued)

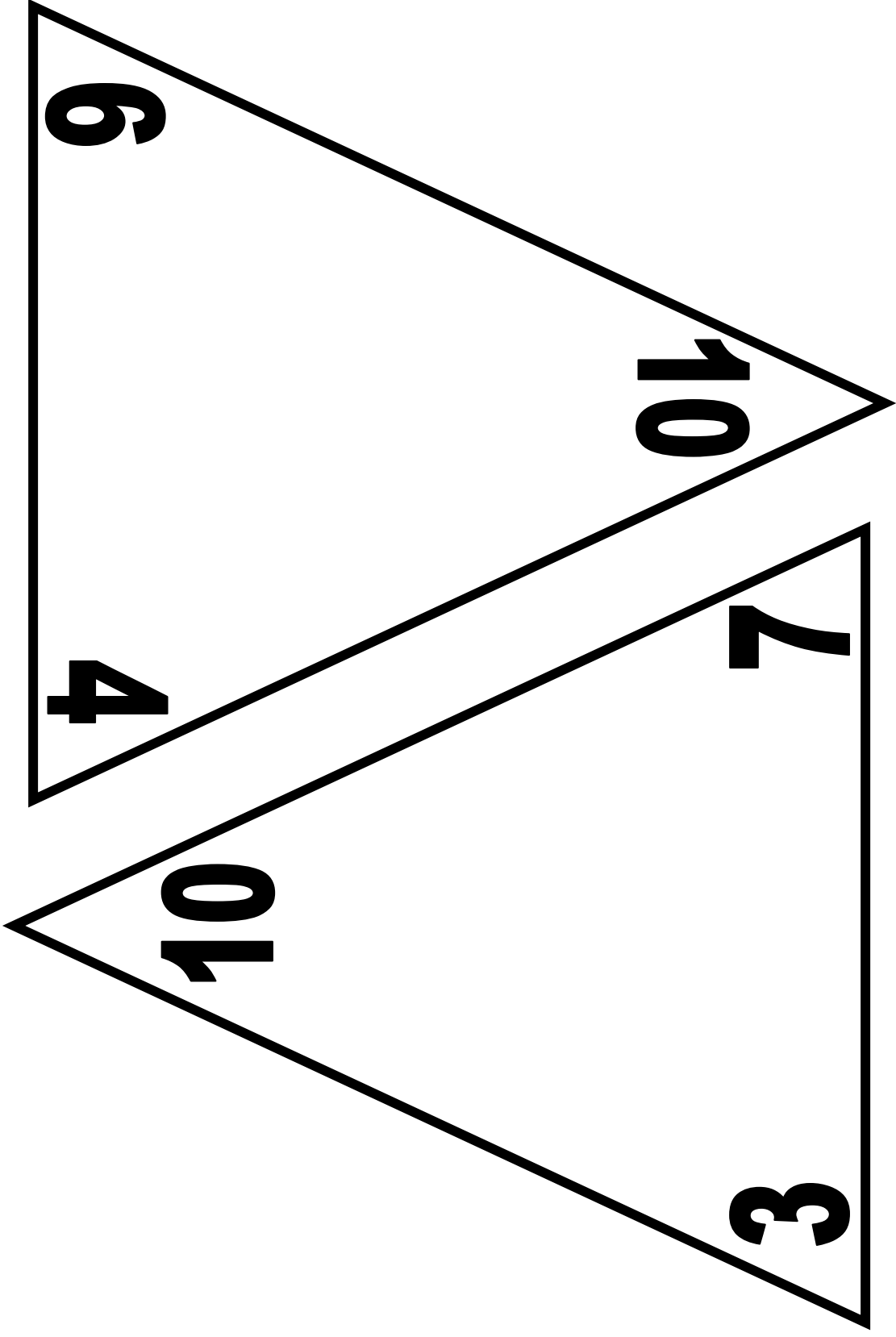

Triangular Flashcards (continued)

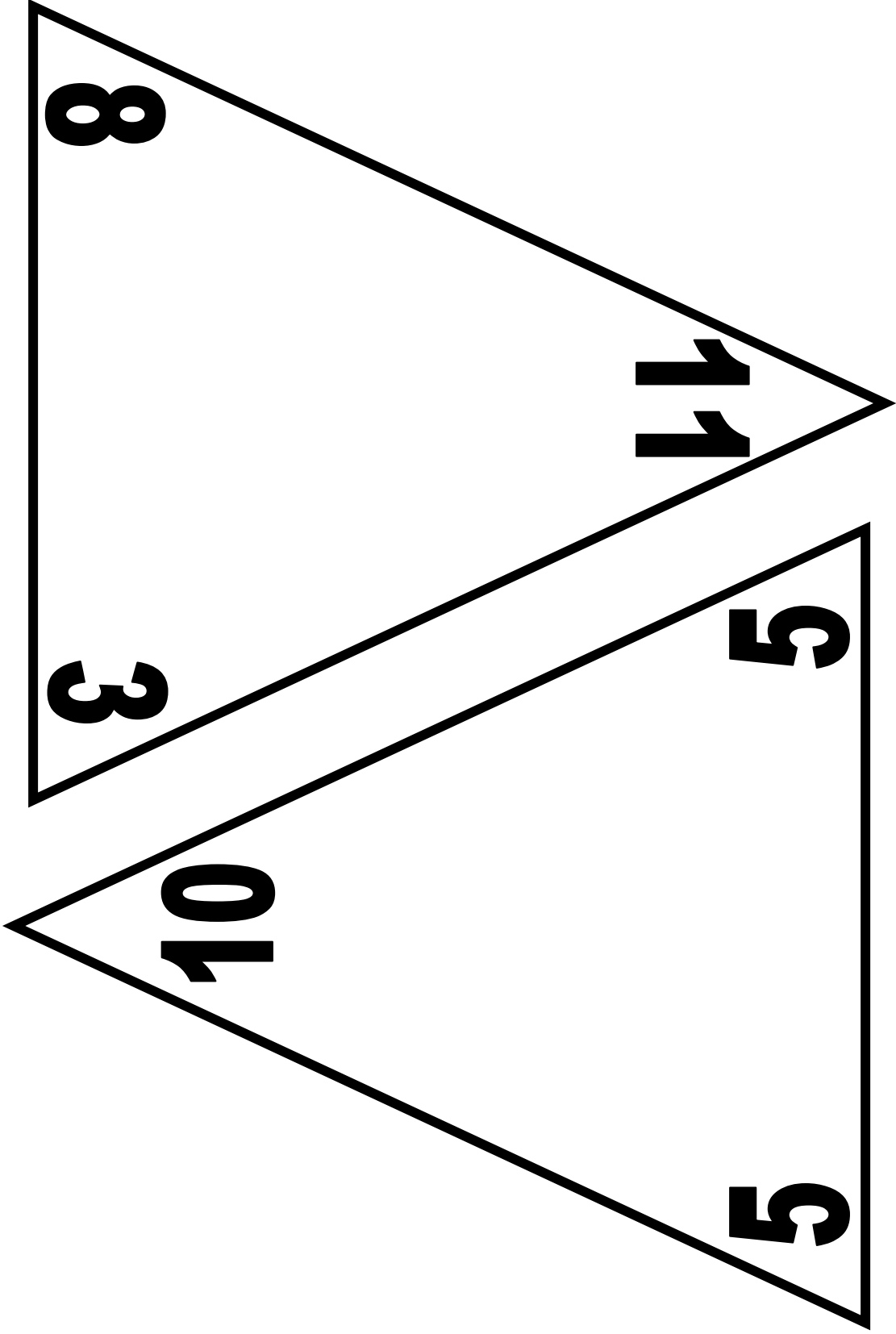

Triangular Flashcards (continued)

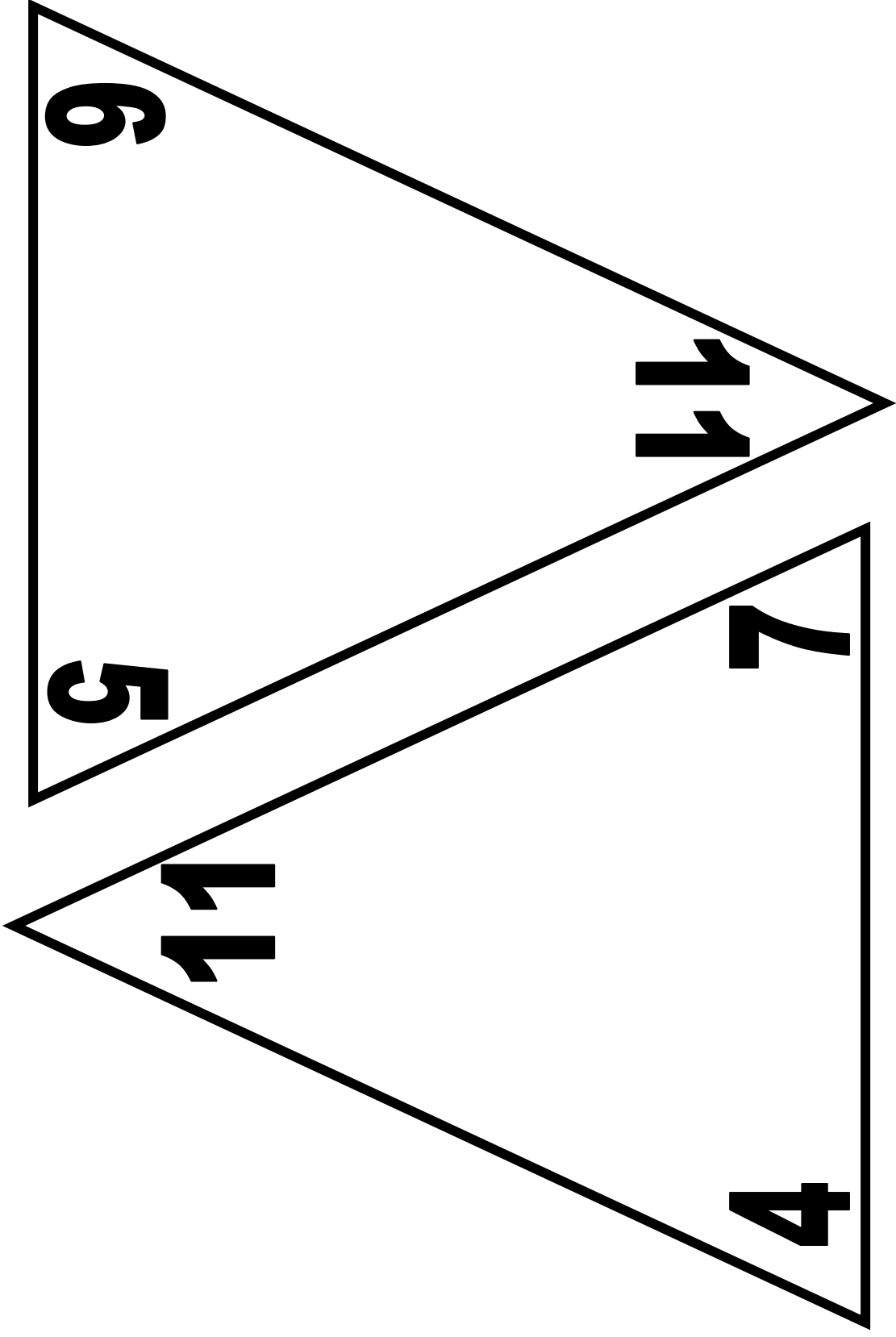

Triangular Flashcards (continued)

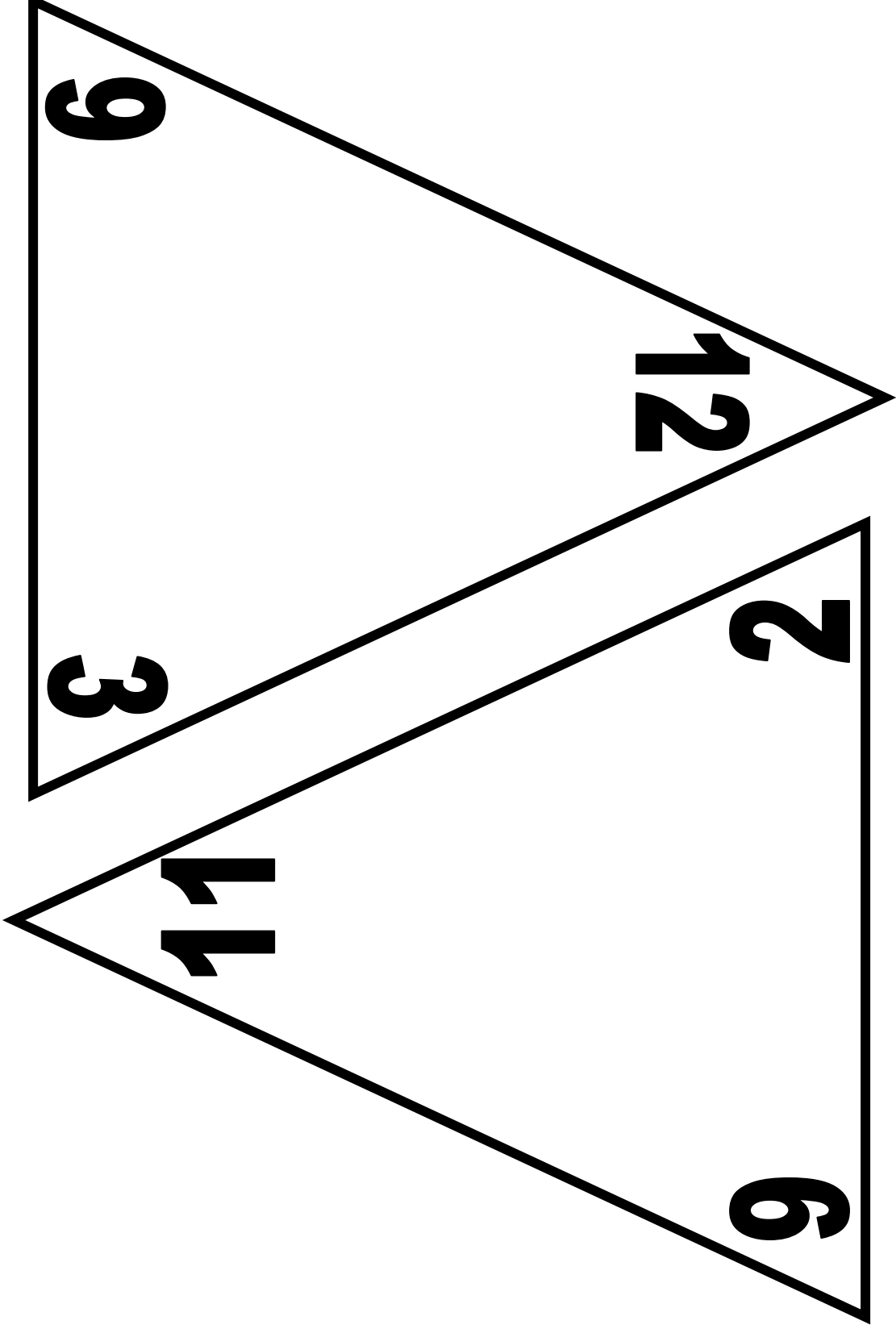

Triangular Flashcards (continued)

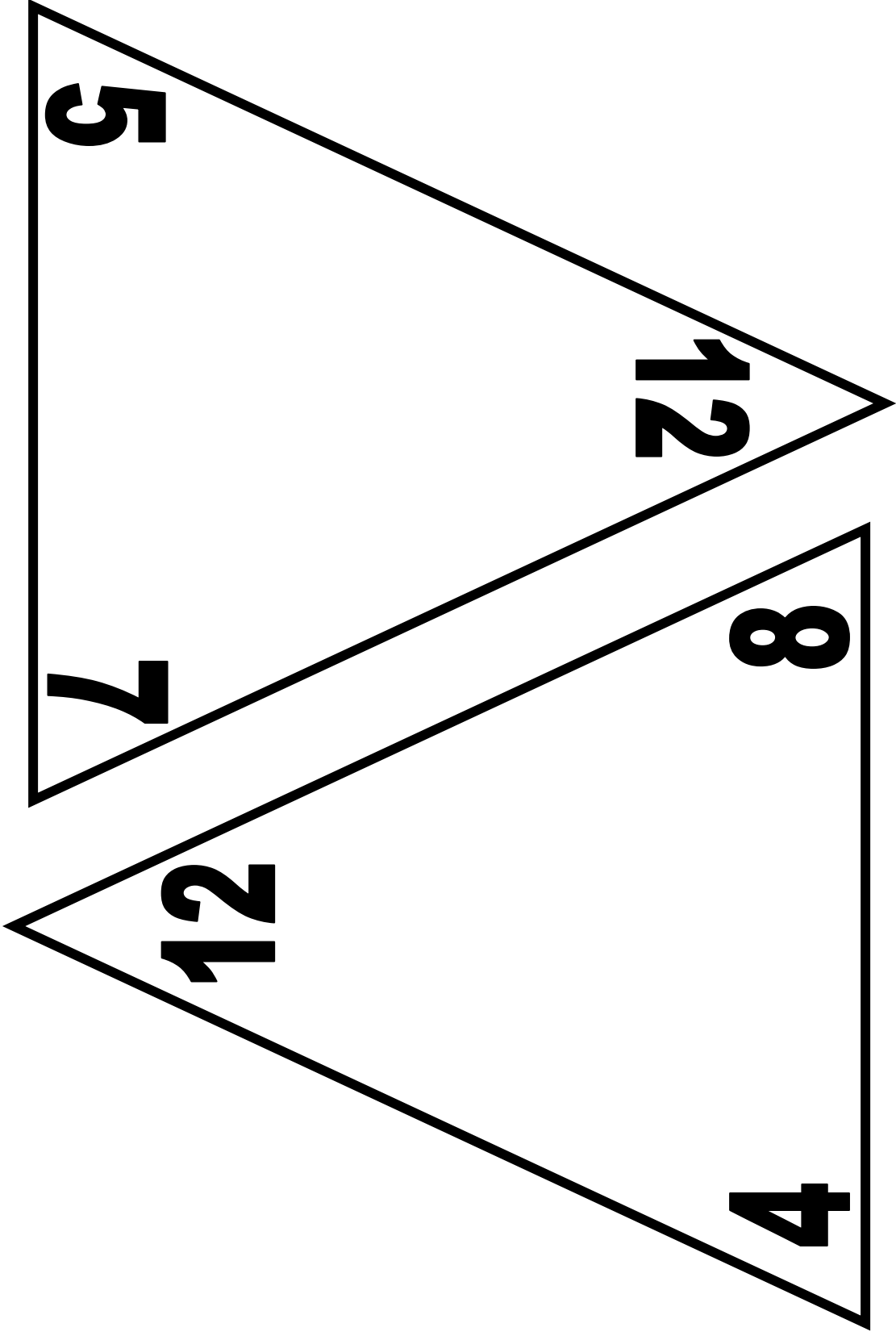

Triangular Flashcards (continued)

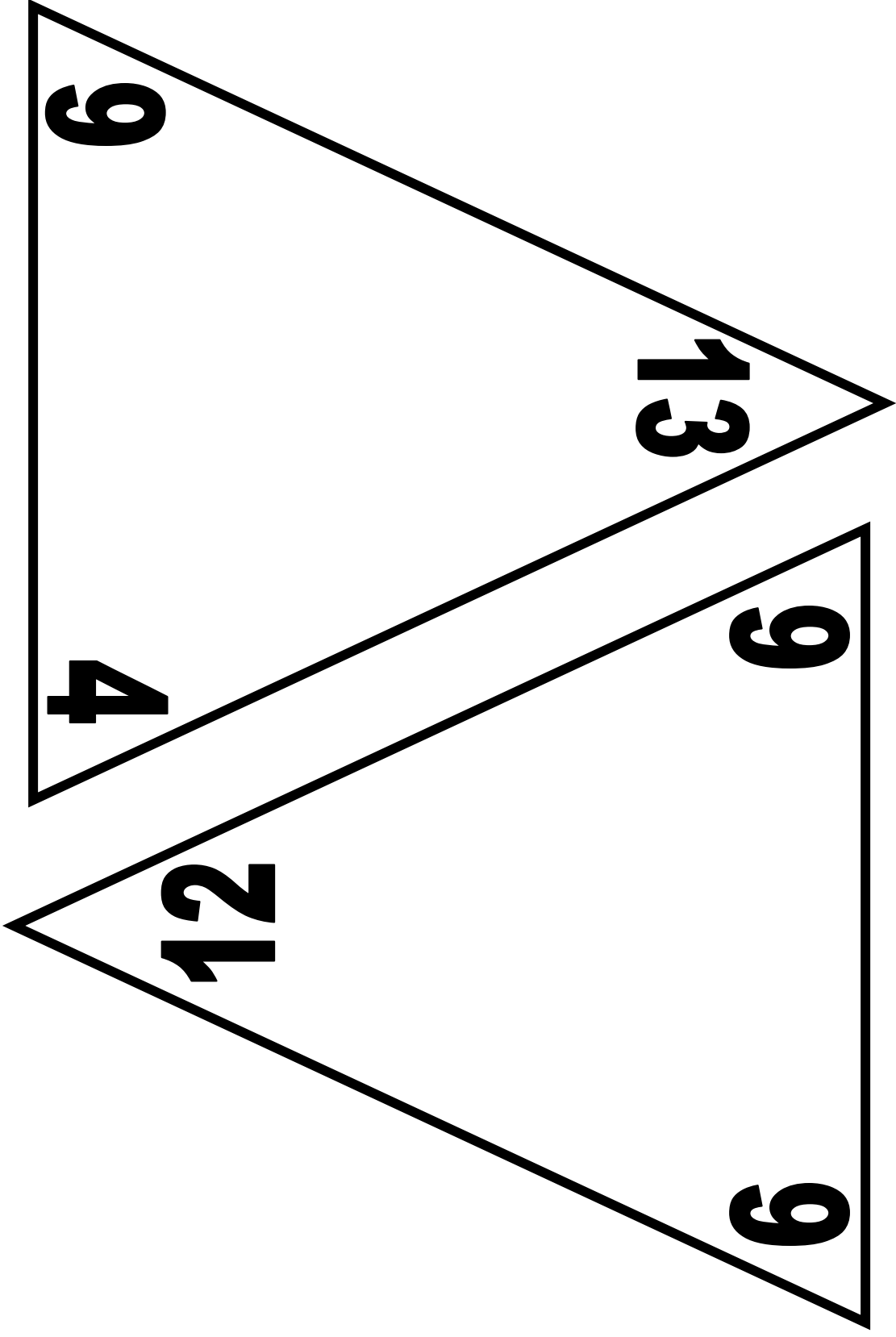

Triangular Flashcards (continued)

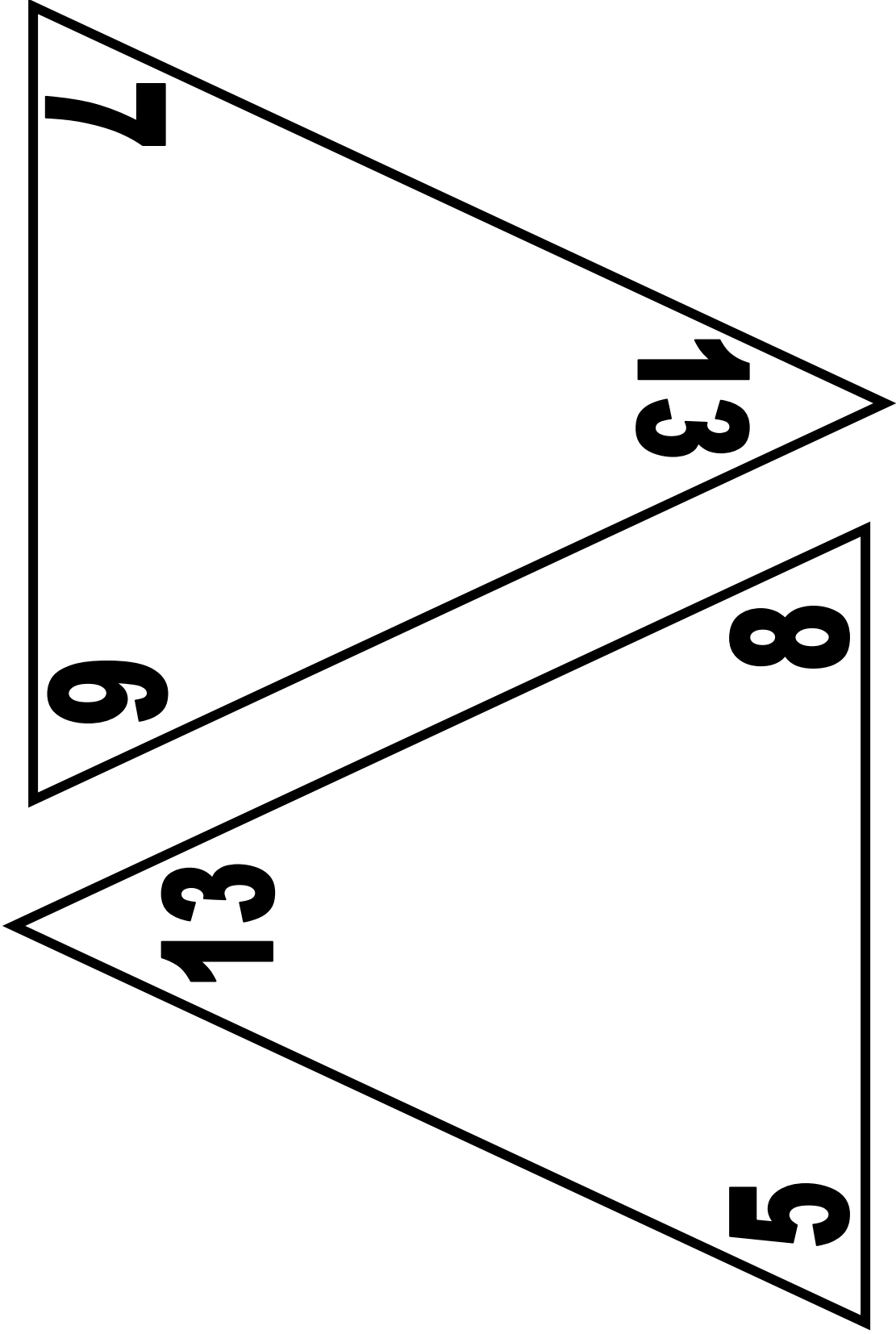

Triangular Flashcards (continued)

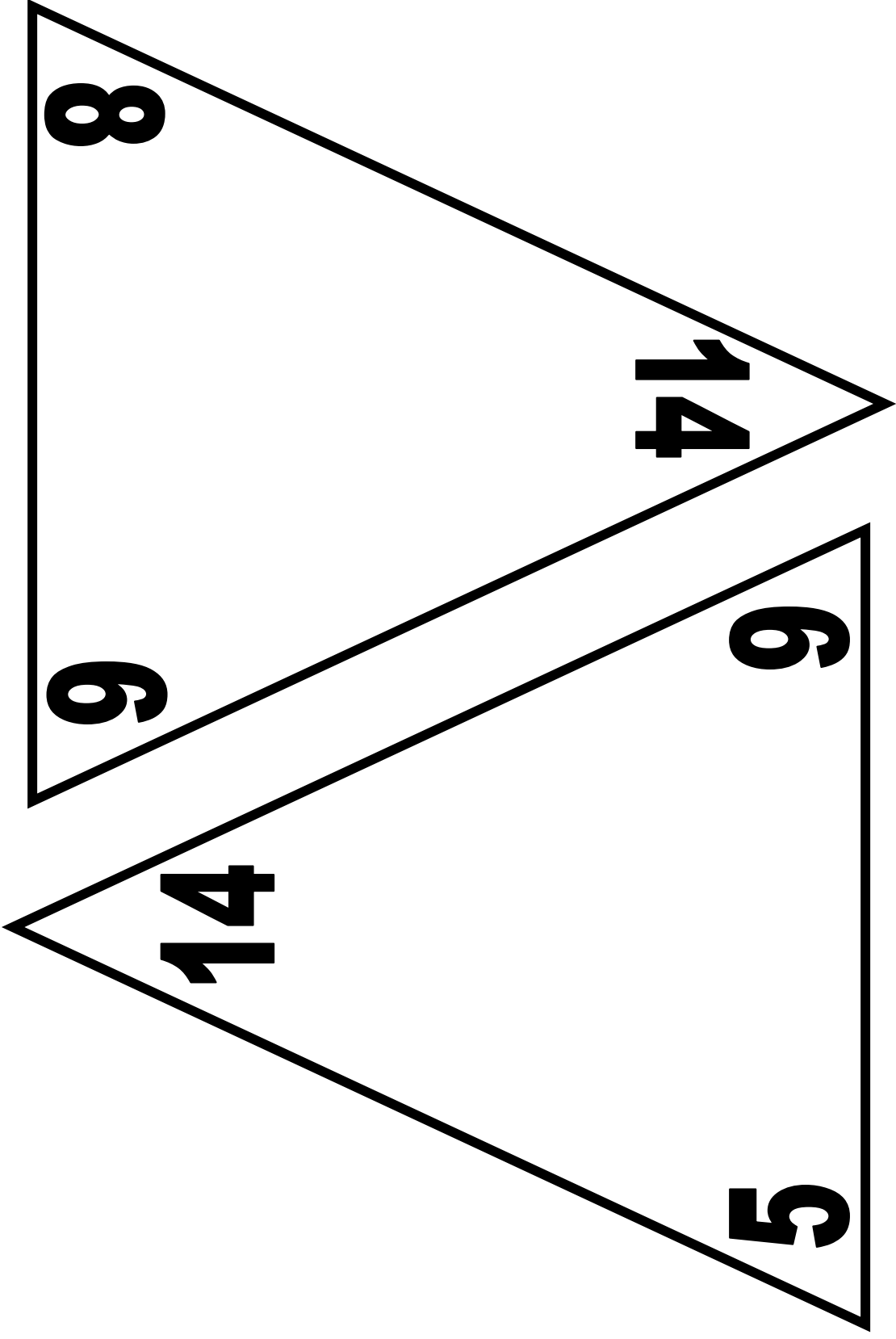

Triangular Flashcards (continued)

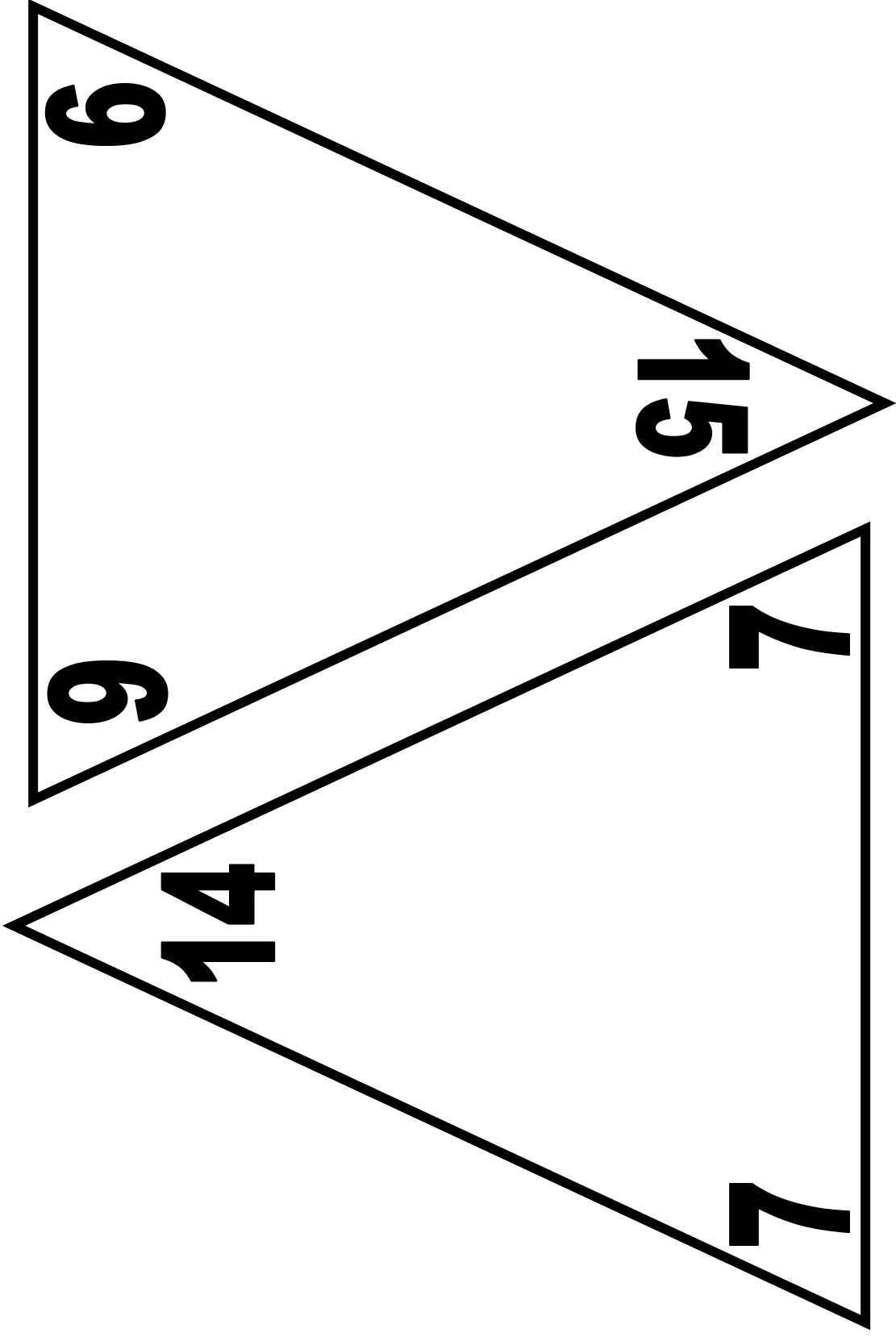

Triangular Flashcards (continued)

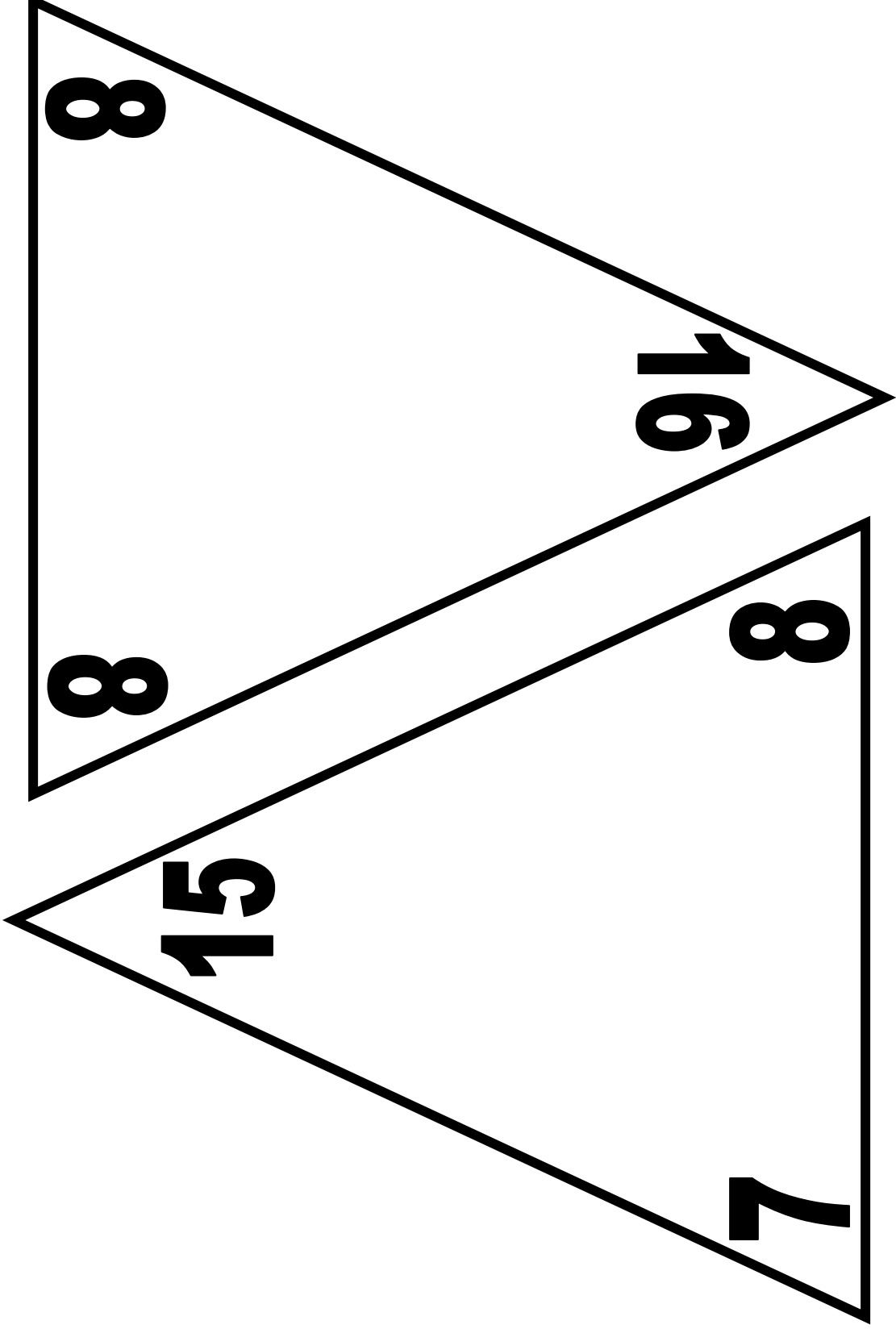

Triangular Flashcards (continued)

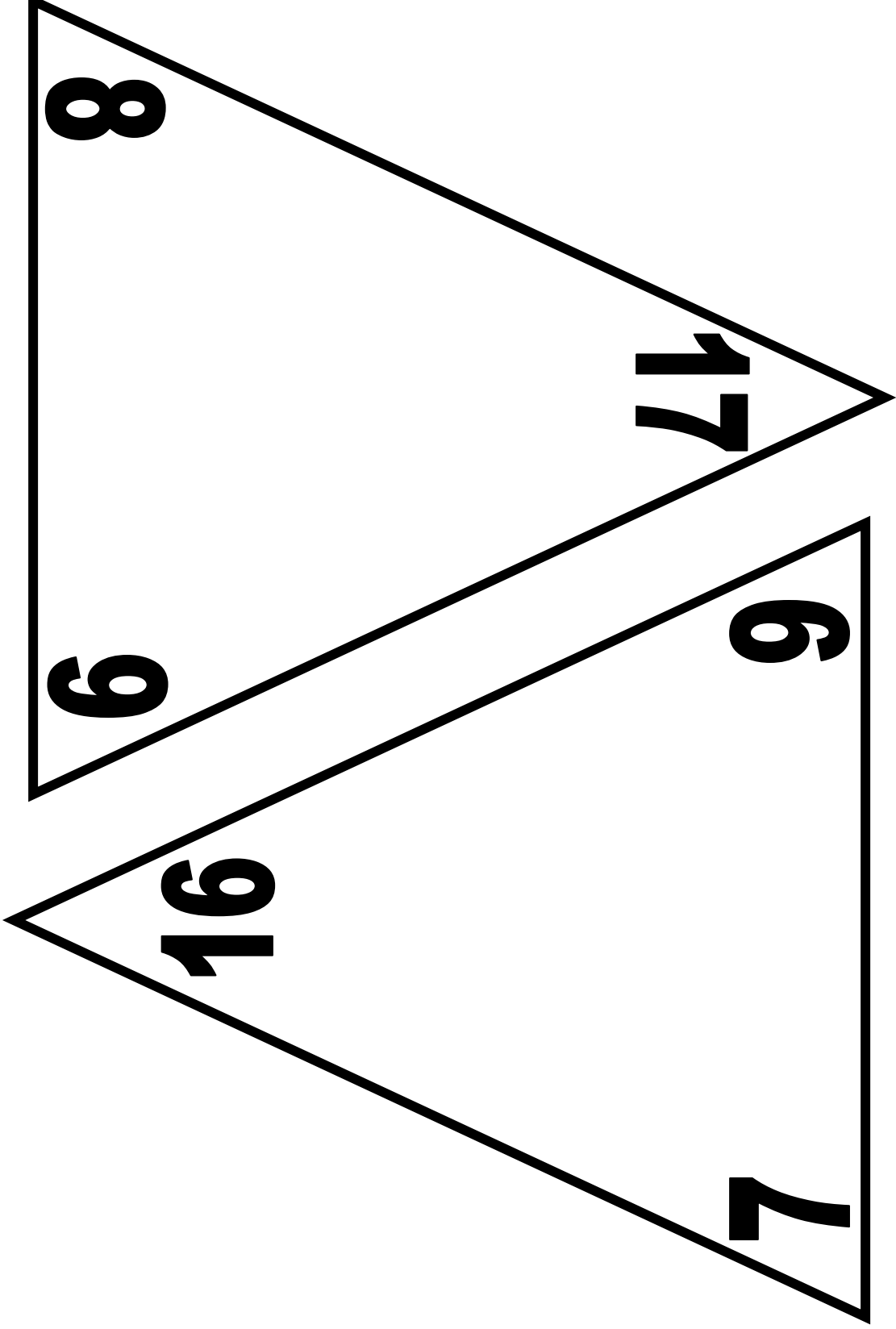

Triangular Flashcards (continued)

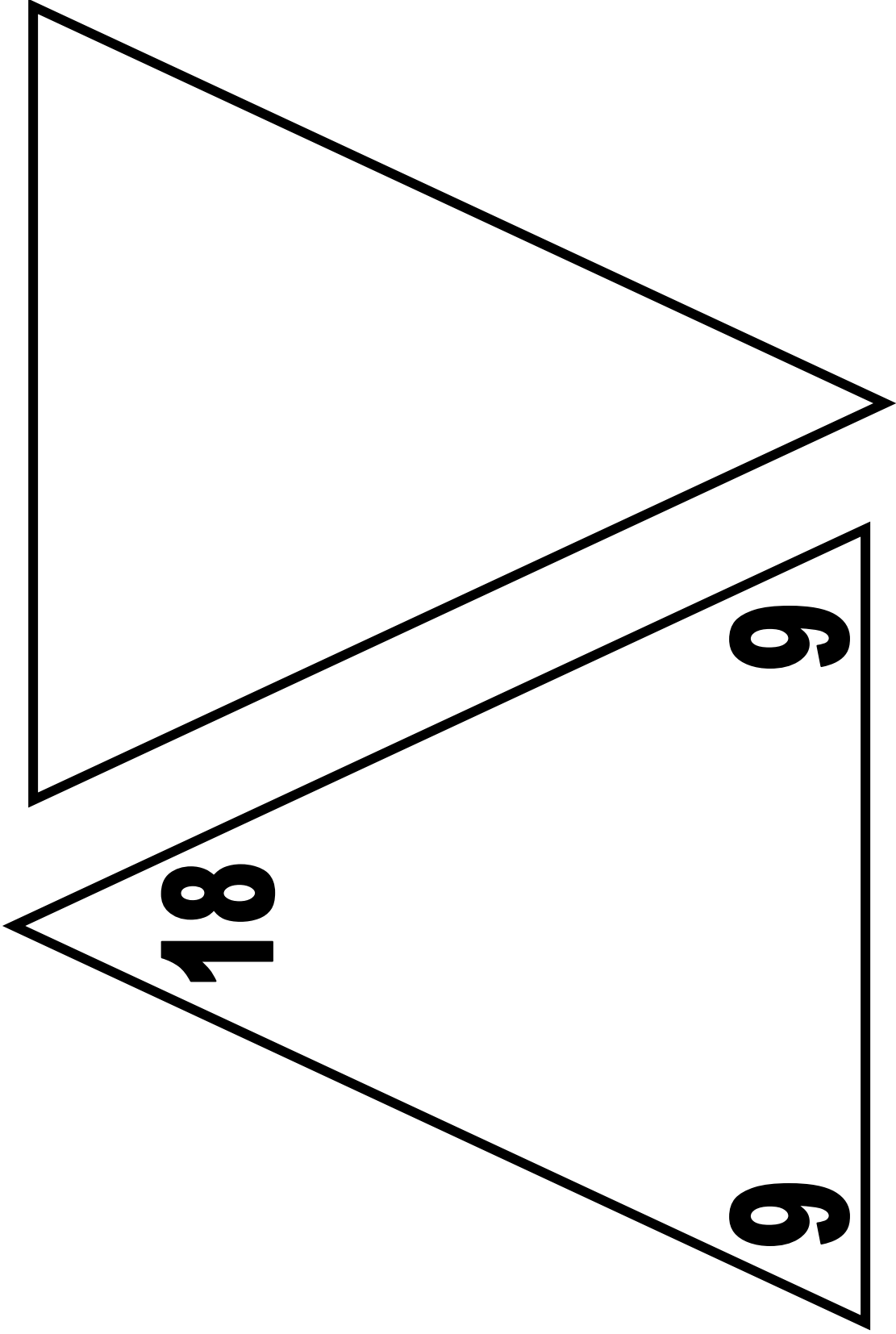

Action Cards

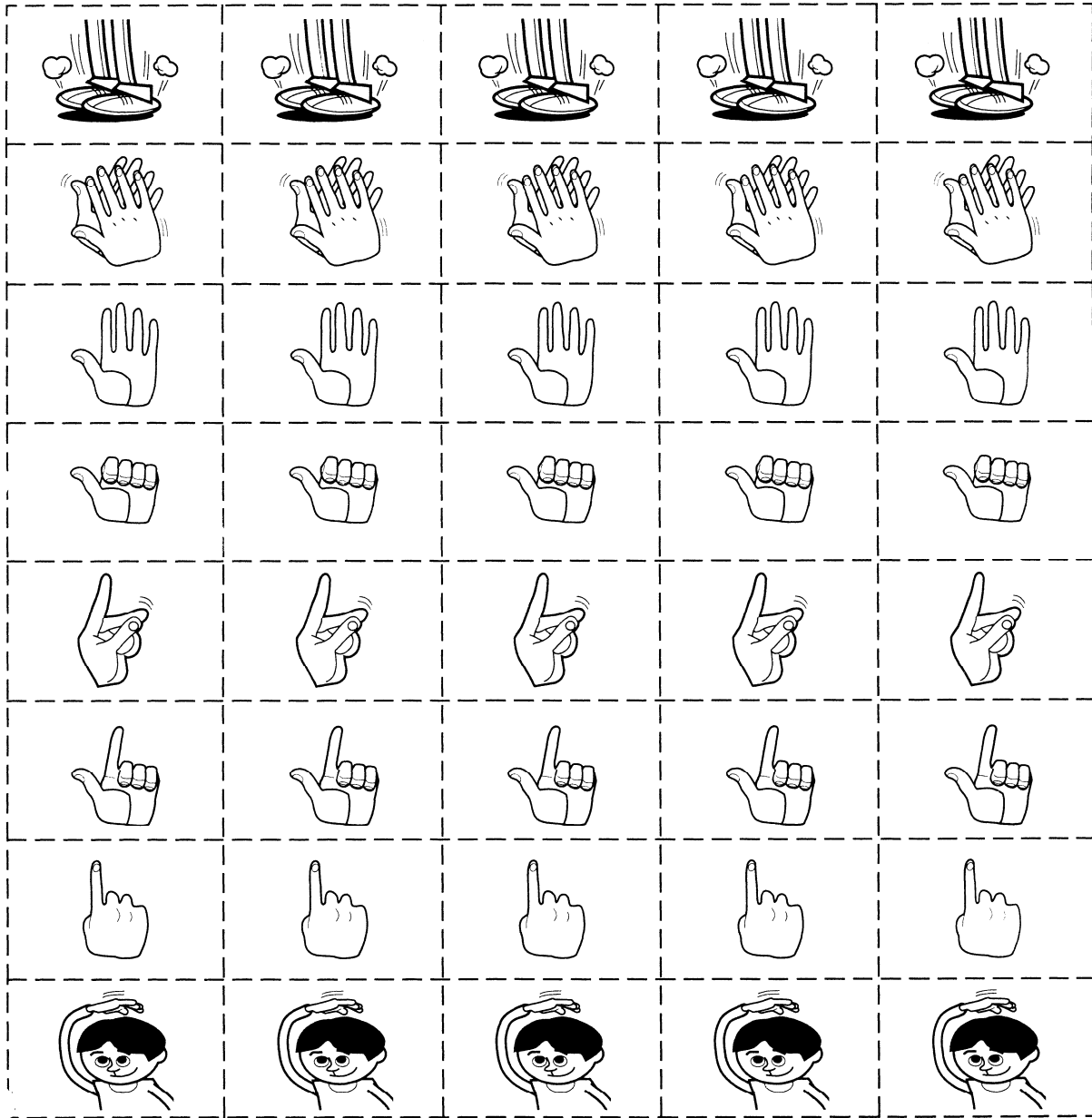

Action Cards (continued)

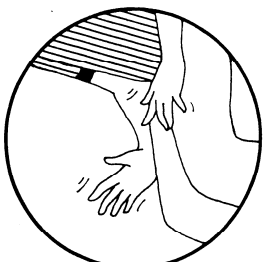
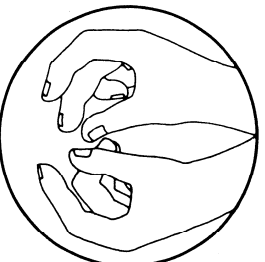
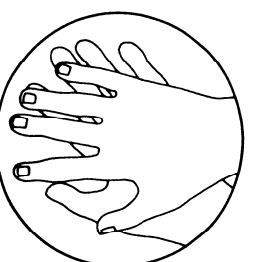
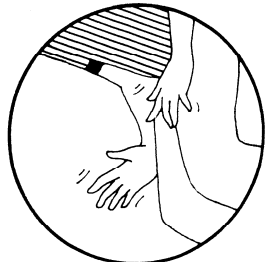
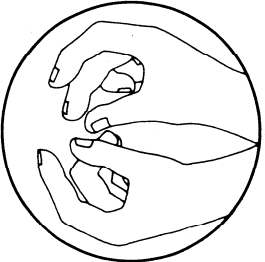
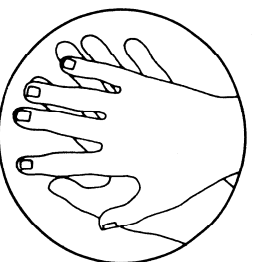
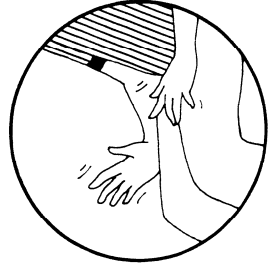
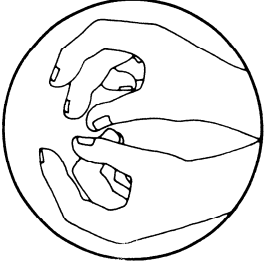
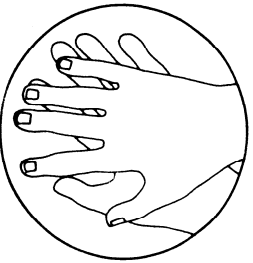
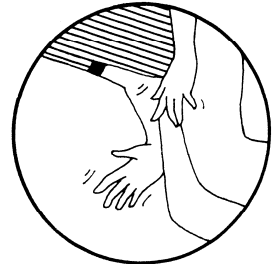
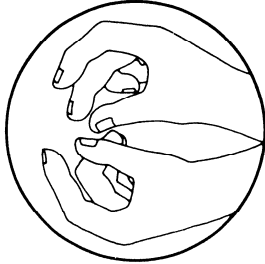
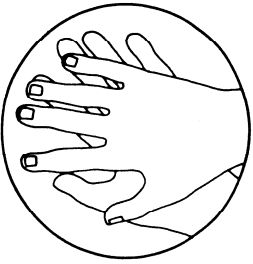
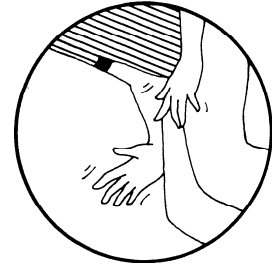
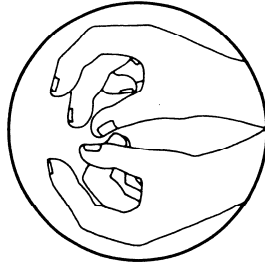
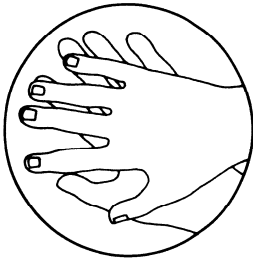

Pattern Detective Centre

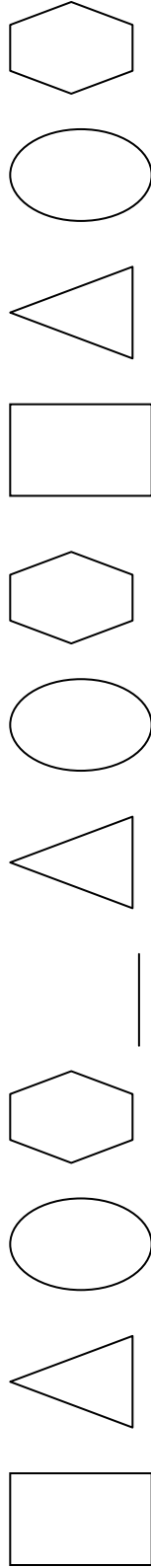
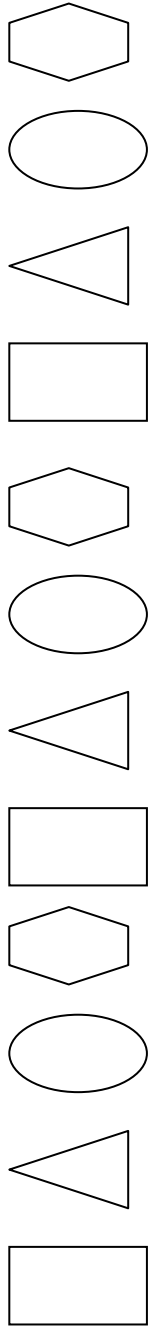
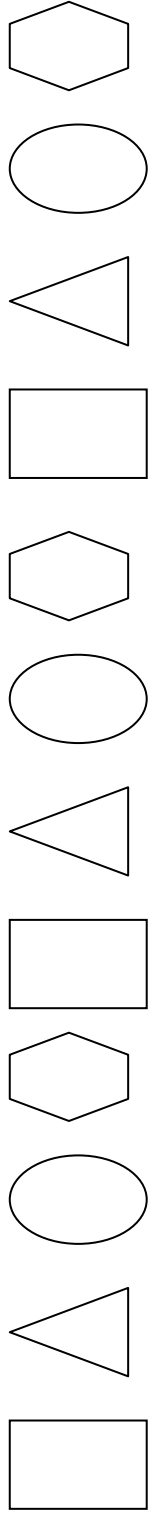

Pattern Detective Centre (continued)

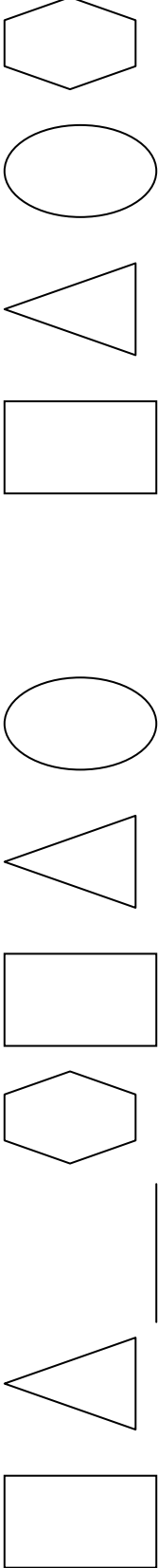
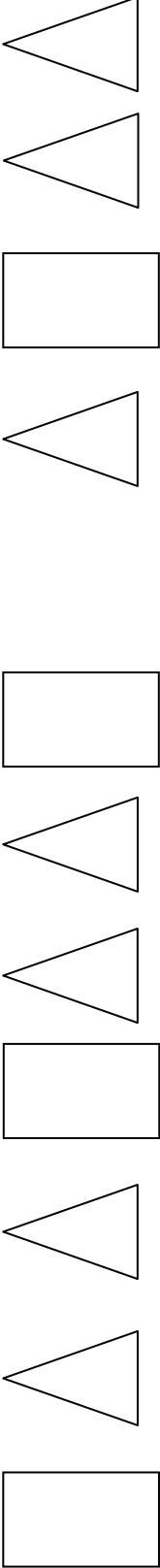
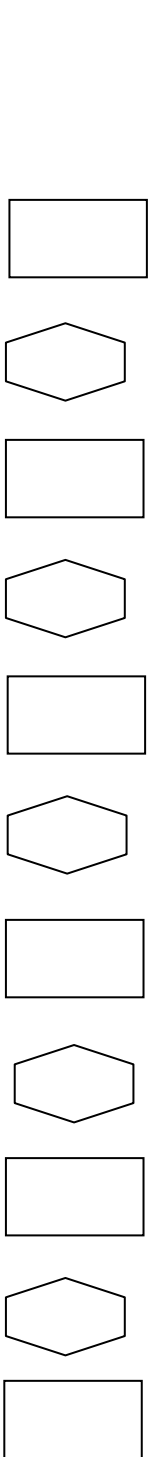
Putting the Pieces Together Representing Patterns

Patterns: Putting the Pieces Together Representing Patterns (continued)

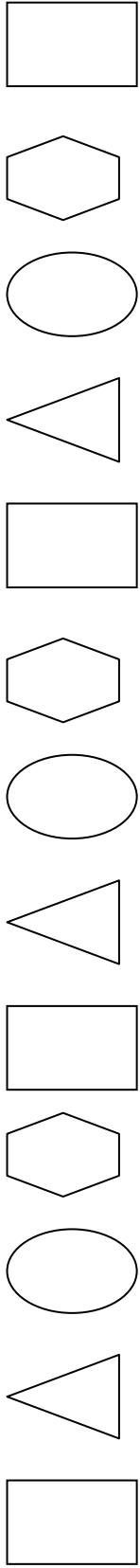
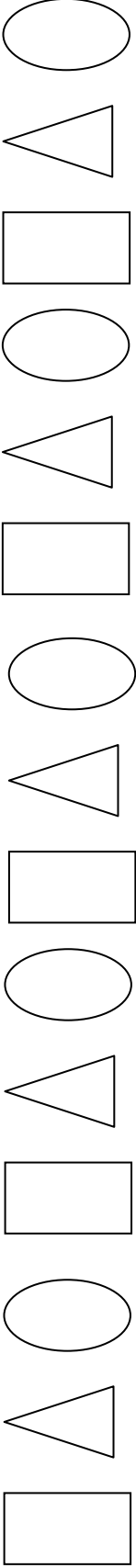
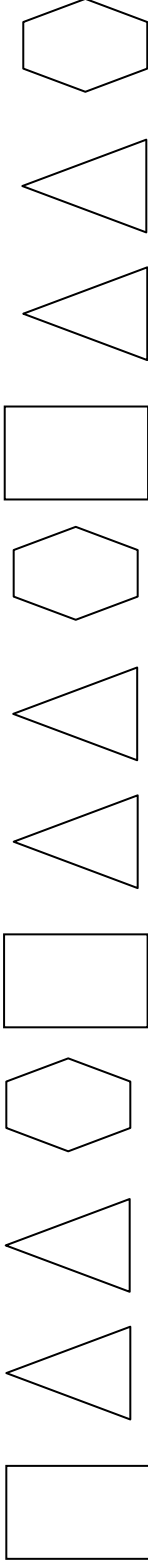

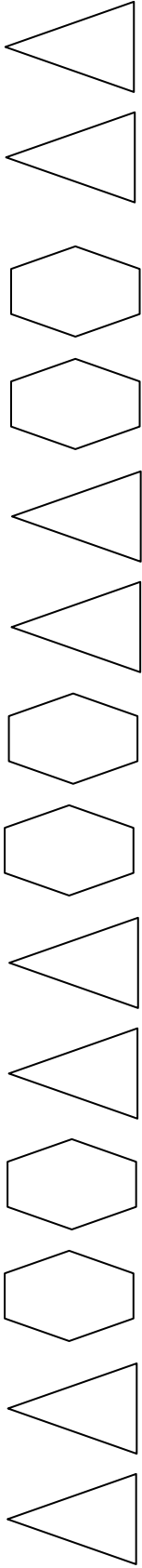
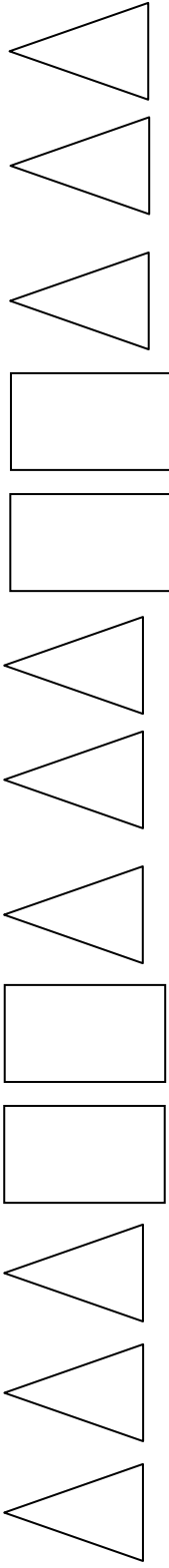
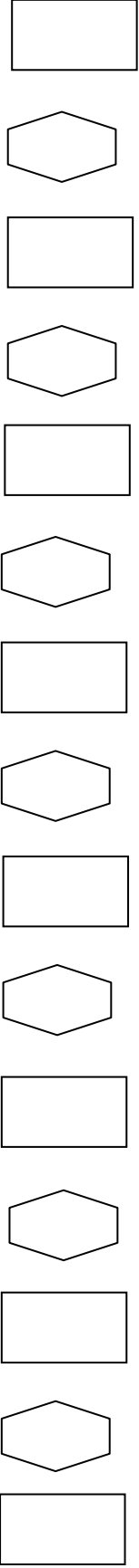

Putting the Pieces Together: Representing Patterns Group Assignment

Name of group members: _____

Represent the pattern below in as many different ways as you can.
Be ready to present your work to the class.

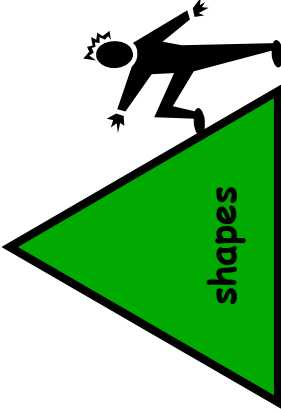
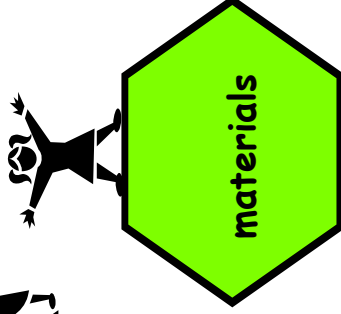
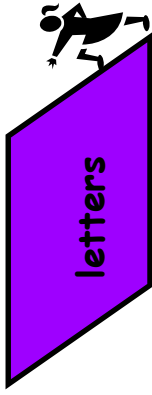
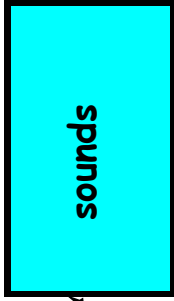
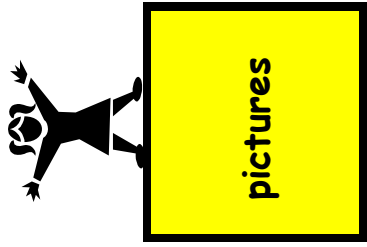
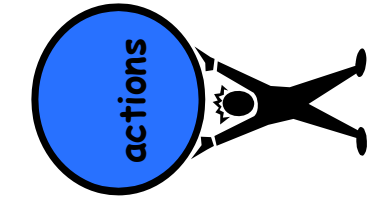
Think about representing the pattern as:



Journal Learning Log Entry

Name: _____

Find an object that is shorter than your pencil and one that is longer than your pencil. Draw and write about what you found.

_____ is longer than my pencil. _____

_____ is shorter than my pencil. _____

Balance Scales

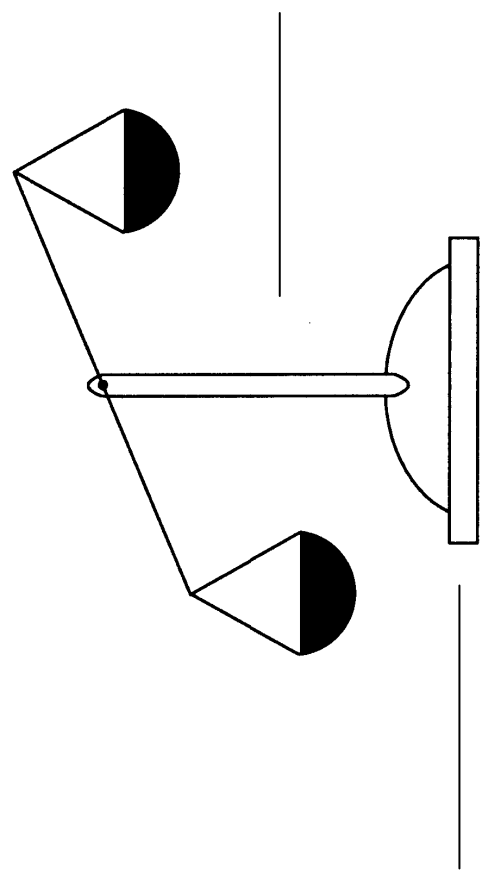
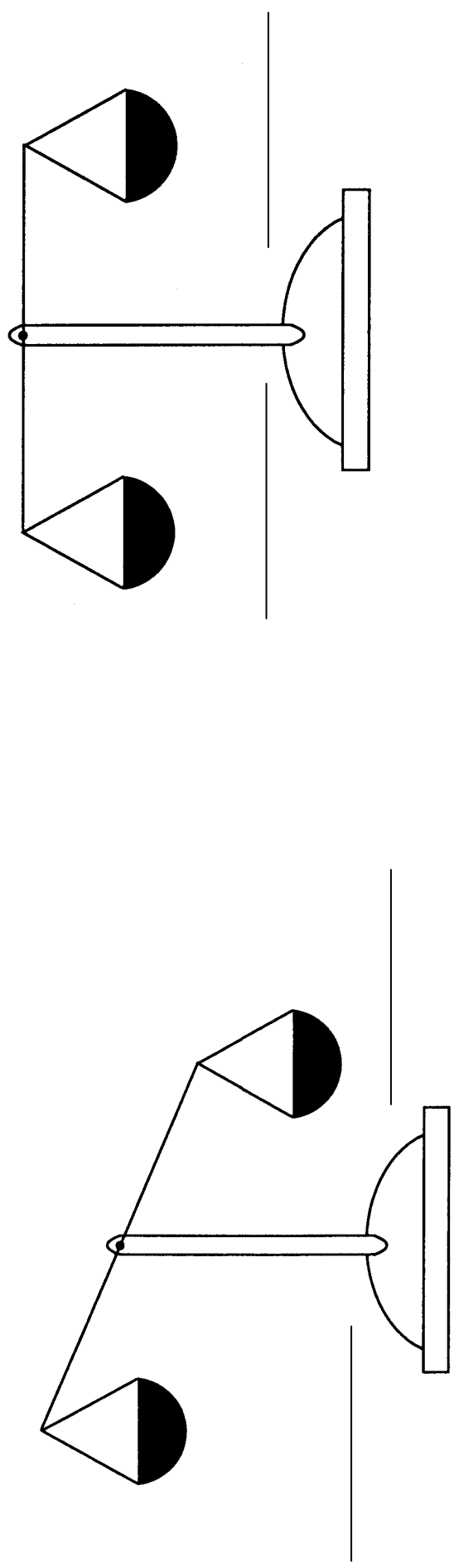

Comparison Centre

length

mass

volume

area

_____ Centre

1. _____ has a larger _____ than _____.
2. _____ has a smaller _____ than _____.
3. _____ has the same area as _____.

Tangram

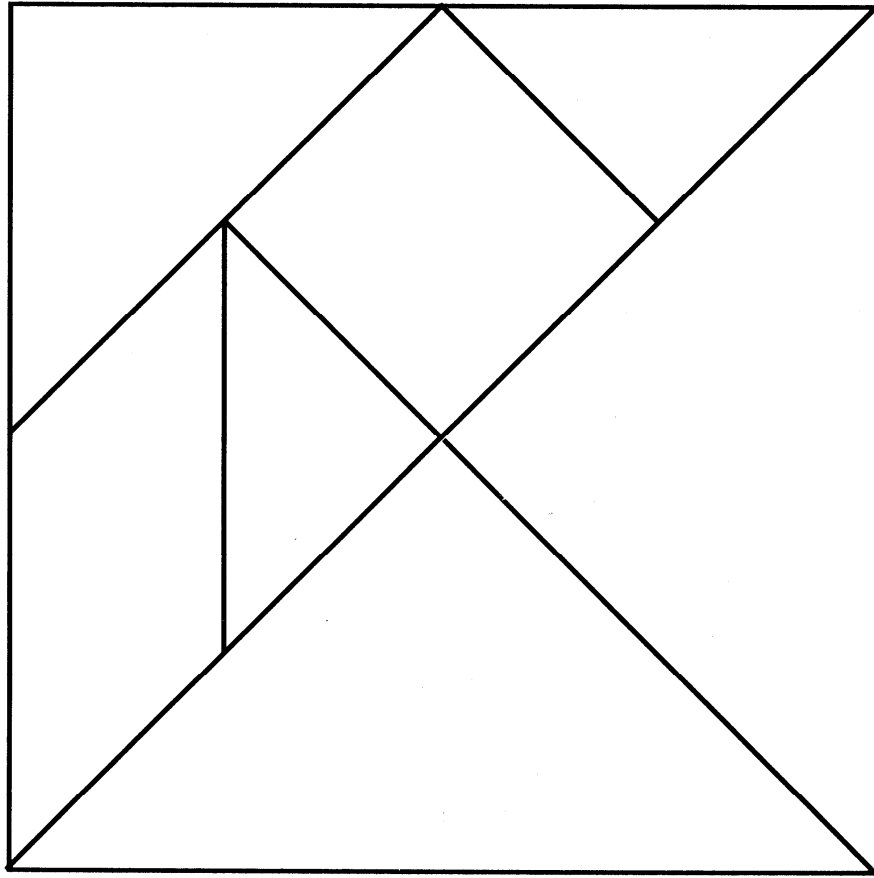

Shapes

