



# MANITOBA SCHOOL BUS DRIVER'S HANDBOOK





**INTRODUCTORY  
INFORMATION**

# PREFACE

---

Over the years the school bus has evolved into a state-of-the-art passenger carrier - arguably, the safest vehicle on the road today. However, without thoroughly trained school bus drivers behind the wheel, its state-of-the-art status is reduced to little more than a "big yellow vehicle with a lot of flashing lights".

The School Bus Driver's Handbook is the product of the Pupil Transportation Unit (PTU), Manitoba Education. Its purpose is to provide school bus drivers with "best known" standard procedures for safe, efficient, economical, and adequate school bus operation.

The Handbook does, from time to time, undergo revision to reflect changes in Provincial and Federal regulations as well as school bus safety standards of the Canadian Standards Association.

This version of the School Bus Driver's Handbook, as has its predecessors, is dedicated to the safety of all children in the province of Manitoba.

# NOTES

---

For the purposes of this handbook, Manitoba Education will be in reference to the official department regardless of the name at any time and will also be called the department. The Pupil Transportation Unit will be acknowledge as PTU or branch of the department.

- ◆ School Bus Driver’s Handbook Version: 2022
- ◆ The Pupil Transportation Unit website can be accessed at:  
[www.edu.gov.mb.ca/k12/ptu](http://www.edu.gov.mb.ca/k12/ptu)
- ◆ Manitoba School Buses Regulation 465/88R can be accessed online at:  
[https://web2.gov.mb.ca/laws/regs/current/\\_pdf-egs.php?reg=465/88%20R](https://web2.gov.mb.ca/laws/regs/current/_pdf-egs.php?reg=465/88%20R)
- ◆ Metric conversions made throughout the Handbook are approximate.

# TABLE OF CONTENTS

---

---

<b>PREFACE</b> .....	i
<b>NOTES</b> .....	ii

## **UNIT A THE SCHOOL BUS DRIVER: ROLE AND RESPONSIBILITY**

Your Responsibility .....	1
Your Passengers .....	2
Public Relations .....	2
Your Supervisor .....	3
Driver Selection .....	3
School Bus Driver Requirements .....	4
Driver's Abstract .....	9
Manitoba's Graduated Driver Licencing (GDL) Program .....	9
Commercial Drivers .....	10

## **UNIT B PUPIL RELATIONS: MANAGEMENT AND DISCIPLINE**

Loading and Unloading .....	11
Danger Zone Diagram .....	13
The School Bus Driver and Student Passengers .....	15
Student Conduct .....	15
Passenger Safety and Carry-On Items .....	16
Communicating With Your Passengers .....	17
Bullying .....	18
Characteristics of Student Behaviour .....	18
Do's and Don'ts .....	21

## **UNIT C PREVENTIVE MAINTENANCE**

Under-the-Hood Checks .....	24
Inside-the-Bus Checks .....	25
Outside-the-Bus Checks (Walk-Around Inspection) .....	30
Bus Cleanliness – Inside and Outside .....	34
Preventive Maintenance While on the Road .....	34
Post-Trip Preventive Maintenance Procedures .....	36

## **UNIT D DRIVING FUNDAMENTALS**

Driving a Larger Vehicle .....	37
Transmissions .....	37
Steering and Turning .....	38
Stopping .....	39
Anti-Lock Brake System (ABS) .....	41
Exhaust or Engine Brake .....	41
While the Bus is Stopped.....	42
Backing a School Bus .....	42
Stopping at a Bus Stop.....	42
Flashing Warning Lights .....	43
“Don’t Pass Law” Violations .....	43
Loading and Unloading at School .....	44
Loading and Unloading Procedures on Route .....	45
Railway Crossings.....	47
Entering the Flow of Traffic .....	49
Lane Use and Positions on Roadway.....	50
Making a Turnaround.....	51

## **UNIT E DEFENSIVE DRIVING**

Driver Condition .....	54
Vehicle Condition.....	54
Adverse Weather Conditions .....	55
Hazardous Conditions .....	59

## **UNIT F ACCIDENT PREVENTION AND EMERGENCIES**

Emergency Driving Techniques .....	63
Accident and Emergency Procedures .....	70

<b>Conclusion .....</b>	<b>76</b>
-------------------------	-----------

## APPENDICES

- Unit B**
- B1 School Bus Seating Plan Samples
  - B2 Safety Rules for Students Riding the School Bus
  - B3 School Bus Misconduct Report
  - B4 *The Public Schools Act - Code of Conduct Regulations*
    - Section 47.1(2)
    - Section 47.1(2.1)
    - Section 58.10
- Unit C**
- C1 School Bus Pre-Trip Inspection Checklist
  - C2 Canadian Motor Vehicle Safety Standards – CMVSS 111 Mirror Testing Protocol
  - C3 Engine Starting and Warm-Up Procedures for Diesel Engines
  - C4 Manual Transmissions – Preventive Maintenance Checks
  - C5 Sample School Bus Idling Policy
- Unit D**
- D1 Manual Transmissions – Driving Fundamentals
  - D2 Sample “Don’t Pass Law” Violation Report
  - D3 *The Highway Traffic Act – Railway Crossings*
- Unit F**
- F1 Manual Transmissions – Brake Loss
  - F2 School Bus Driver Electrical Safety
  - F3 Pupil Transportation Unit’s School Bus Accident Report Form
  - F4 School Bus Evacuation Procedures



U

N

I

T

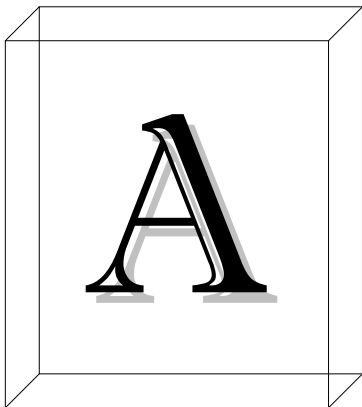

**THE SCHOOL BUS  
DRIVER:**

**ROLE AND  
RESPONSIBILITY**

# THE SCHOOL BUS DRIVER: ROLE AND RESPONSIBILITY

The transportation of pupils to and from school is an integral part of the education system. The competence of school bus drivers and the uniformity of driving procedures have a definite effect on the safe, economical, adequate, and efficient operation of the school bus.

Before getting behind the wheel of a school bus there is a great deal you need to know about yourself and your responsibilities, as well as the responsibilities of others on the "safety team" including teachers, principals, and parents.

Learning to drive a vehicle the size of a school bus is a complex task involving knowledge of laws and regulations; visual, mechanical, and human relations skills; judgements; decisions; and accurate response. Your performance as a school bus driver will depend on your personal dedication to learning all aspects of the job.

- ◆ You are important. It is evident that you, the professional school bus driver, are a very important person, with responsible duties in providing an education opportunity for students. In many instances, you will be the first representative of the school system to meet students in the morning and the last to see them at night. You are in a position to have considerable influence on their attitudes toward school.
- ◆ You are responsible. Like the captain of a ship, the school bus driver is responsible, under the direction of the school division, for efficient operation of the school bus and the safety and discipline of its passengers. While passengers are on the bus, their safety is in your hands.
- ◆ You are a member of the safety team. Students transported in school buses are exposed to a variety of hazards that could cause injury or death not only on the bus, but also when they are arriving at, or returning to, their bus stop. You, as the most important member of the safety team, must constantly strive to improve operational safety in these areas. You, as a school bus driver, virtually have the lives of these individuals in your hands.

## YOUR RESPONSIBILITY

A professional school bus driver accepts responsibility. When you drive a bus carrying passengers in varying conditions, you are charged with a serious responsibility.

The vital links to safety include proper driver attitude, knowledge, and skill, which can be developed through your interest in safe driving.

Your ability to cope with a constantly changing driving environment demands both pre-employment preparation and continual in-service training. You must constantly evaluate your driving technique and ability to handle the demands of the job.

It is important that you are physically and mentally prepared and evaluate yourself on a daily basis to drive your bus.

Because you are a professional school bus driver, you are expected to meet a high standard of conduct. Recognize that students and their parents place a great deal of confidence in you. You should act in ways that deserve this confidence. Consider the following attributes of the professional school bus driver:

- ◆ Realize the confidence and trust expected of you while performing your duties.
- ◆ Observe legislation, regulations, and policies including *The Highway Traffic Act*, *The Public Schools Act*, and school board policies.
- ◆ Familiarize yourself with Manitoba Regulation 465/88R – The School Buses Regulation (Appendix-A1).
- ◆ Be dependable; a person who can be relied upon to do the job efficiently and effectively.
- ◆ Be mentally prepared to work effectively and patiently with students, parents, and school officials.
- ◆ Be prepared to handle unexpected and unusual situations such as weather conditions or mechanical failure.
- ◆ Be prepared to assist individuals having trouble.
- ◆ Be patient and understanding towards others.
- ◆ Maintain a neat and clean personal appearance. You are regarded as a symbol of the entire school system.
- ◆ Refrain from smoking in the school bus at all times.
- ◆ Understand the adverse effects of medication, alcohol, and drugs which may impair your ability to do the job. The school bus driver must abstain from using alcohol at least eight hours prior to operating a school bus.
- ◆ Refrain from using profanity.
- ◆ Be sufficiently rested.

## **YOUR PASSENGERS**

A positive relationship with your passengers will assist in your job. Their conduct will depend a great deal, on what you say and do. Learn the names of the students on your bus and greet them in a friendly manner. Your expression of interest in students will assist in gaining their confidence. To avoid distraction, an essential part of your job is to maintain order on the bus. Your school division will establish procedures and policies regarding school bus ridership. The driver must be aware of these procedures and policies in order to communicate effectively with students.

Compliment your passengers when they exhibit good conduct or sound judgement. Avoid physical contact with students.

There must be communication between driver and passenger when loading and unloading. You should help your passengers understand what is accepted as normal and proper behaviour on the school bus. Maintain a business-like, yet friendly, relationship with all students. Be responsive to their needs.

## **PUBLIC RELATIONS**

Good public relations depends on your ability to promote good opinions of your school division and yourself. The way you do your job will reflect on the public's perception of the entire school system. The careful, courteous driver makes a good impression.

Your reputation in the community, your respect for students and their parents, and your willingness to prepare yourself for your position will create public confidence in the entire system. Avoid public confrontations. If personal animosity with a parent exists on your route, discuss the situation with your supervisor.

Law enforcement officers in the community, as well as crossing guards, are part of the safety team. Their job, as well as yours, is to ensure safety.

Building positive public relations is a continuous process. It depends greatly on the attitude you bring to work each day. The driver who is proud of the job will not intentionally damage the system's reputation. This attitude assists in sustaining public relations – the good opinion of the public.

Solid relationships within an organization are also an important component of positive public relations and begin with fellow school division employees. An organization whose members display mutual friendliness, interest, and respect for each other has met a major requirement of good public relations.

## **YOUR SUPERVISOR**

A school division or company manager has the responsibility of supervising you as an employee. Your supervisor is another member of the safety team and is vitally interested in both the safety of your passengers and in the efficiency and economy of operation. As a school bus driver, you can assist your supervisor by:

- ◆ Understanding and accepting your share of responsibility.
- ◆ Being capable and willing to accept supervision and advice.
- ◆ Exhibiting interest in employment assignments.
- ◆ Learning and accepting training.
- ◆ Carrying out assignments completely and in a positive manner.
- ◆ Having medical examinations as required.
- ◆ Knowing school division policy and supporting it.
- ◆ Not repeating information of a personal or confidential nature.
- ◆ Communicating with your supervisor.
- ◆ Advising your supervisor of school bus vehicle conditions, road conditions, and/or changing conditions at student pick-up and drop-off locations.
- ◆ Reporting discipline problems to both the school principal and your supervisor.
- ◆ Submitting all required reports to your supervisor. Be sure to report all accidents or incidents (i.e. involving property, pedestrians, vehicles, animals, and passengers) whether or not damage is evident.
- ◆ Assisting with problem-solving such as school bus ride times, potential route hazards, equipment repair solutions, loading/unloading concerns at designated pick-up and drop-off locations, and general aspects of pupil safety which may require improvement.

## **DRIVER SELECTION**

School bus drivers should be physically fit, skilled in the operation of their vehicles, and show interest in the students they transport. They must be steady in temperament, able to adjust to

varying conditions of their job, and have positive attitudes toward safety. Manitoba Public Insurance (MPI) requires that the minimum age for a driver holding a Class 2F licence be 18 years of age. The department recommends that a school bus driver have a clear driver's abstract.

### **Personal Habits and Character**

The school bus driver should:

- ◆ Abstain from using alcohol at least eight hours prior to operating a school bus.
- ◆ Appear clean, neat, and suitably attired in accordance with the employer's dress code.
- ◆ Abstain from smoking in the school bus at all times.

## **SCHOOL BUS DRIVER REQUIREMENTS**

### **Becoming a School Bus Driver If You Currently Hold a Class 5F Driver's Licence**

To operate a school bus for Manitoba's public schools, individuals are required to meet all training and testing requirements of both MPI and the department. While there is no prescribed order for taking the training required of these two organizations, the Pupil Transportation Unit recommends that individuals begin with the department requirements. This specialized school bus training, combined with assistance from your instructor, will be an asset as you complete MPI's requirements. An overview of all requirements is presented below.

### **Class of Driver's Licence**

In Manitoba, an individual who operates a school bus carrying passengers must hold a class of driver's licence for the size of vehicle being operated. *The Drivers and Vehicles Act*, Regulation 47/2006 provides definitions of Class 2 and Class 4 vehicles.

#### **NOTE . . .**

*The Pupil Transportation Unit strongly recommends that school bus drivers in Manitoba hold a Class 2F driver's licence, thus allowing the option to operate every size of school bus.*

### **Manitoba Public Insurance (MPI) Licencing Requirements for Class 2F**

Before being issued a Class 2F driver's licence for operating a school bus, the applicant will be required to pass a medical examination, written knowledge tests, and a road test in a school bus vehicle. Specific information on each of these steps is outlined below.

#### **1. Medical Examinations**

A driver applying for a Class 1, 2, 3 or 4 licence must file a mandatory Medical Examination Report. Applicants are permitted to take the Class 1, 2, 3 or 4 knowledge test before the Medical Examination Report is approved. The medical report is valid for six months from the

date your physician completes it. Your Authorized Instruction must be obtained within this six-month period. The knowledge test must be successfully completed and the Medical Examination Report approved prior to being issued Authorized Instruction. People with certain medical conditions may be prohibited from holding a Class 1, 2, 3 or 4 driver's licence. However, most people with medical conditions or physical disabilities may be considered for a higher licence class provided specific medical standards are met. Drivers who are prohibited by the Registrar of Motor Vehicles to apply for a higher licence class are informed of their right to appeal the decision to the Medical Review Committee once complete medical information is filed.

## Hearing

Drivers must meet specific hearing standards depending upon the class of licence desired and the type of goods transported. If a hearing impairment exists, an audiogram report may be required. Hearing aids may be used to achieve the hearing standards.

## Vision

Class 1, 2, 3 and 4 (emergency vehicles) drivers must have a vision acuity no less than 6/9 with both eyes open and examined together with the worse eye no less than 6/30. Visual fields must not be less than 150° with both eyes open and examined together. Drivers who are applying for a Class 1, 2, 3 or 4 driver's licence and who require corrective lenses to meet the required visual standards may pass their vision screening while wearing glasses or contact lenses. Drivers wearing contact lenses are advised to carry glasses with them at all times while driving since there may be times when contact lenses have to be removed because of eye irritation.

### **NOTE . . .**

**Applicants are responsible for the costs relating to medical reports and related examination tests or telephone calls to a physician.**

## Medical re-examinations

Under The Drivers and Vehicles Act, the Registrar of Motor Vehicles requires certain drivers to be medically re-examined to determine their fitness and ability to drive. All Class 1, 2, 3, and 4 drivers must submit a Medical Examination Report form:

- every five years to age 45
- every three years to age 64
- annually at age 65 and over

Drivers may also need to be retested for their class of licence related to a medical condition. This may include a vision screening, a knowledge test and a road test in the type of vehicle for the class of licence held. A pre-trip inspection and air brake inspection may also be required. Drivers may change to a lower driver's licence classification if they do not wish to hold the higher classification. In such cases, the medical requirements of the lower licence classification must be met.

For information regarding Medical Examination Report, forms or questions about a medical condition please contact:

### **Manitoba Public Insurance**

Driver Fitness  
Box 6300  
Winnipeg, Manitoba, R3C 4A4  
Telephone: 204-985-1900  
Toll free: 1-866-617-6676  
Website: [www.mpi.mb.ca](http://www.mpi.mb.ca)

## **2. Written Knowledge Tests**

If the applicant currently holds a Class 5F driver's licence and plans to operate a school bus, driver they will be required to write a Class 2 knowledge test and a school bus knowledge test based on the Manitoba School Bus Driver's Handbook, the MPI Driver's Handbook, and the Professional Driver's Manual. These tests can be booked at an MPI Service Centre or Autopac agency. When preparing for written tests, keep in mind they are **not** an open-book format.

## **3. Authorized Instruction**

Upon successful completion of the written knowledge tests and having met medical standards, MPI will issue the applicant a temporary driver's licence (a paper copy) certificate (valid for 45 days) allowing "Authorized Instruction". (A permanent one-piece driver's licence will follow in the mail.) While acquiring a Class 2F designation for the purpose of operating a school bus, your class of driver's licence will be identified as Class *5F2A*. This "Authorized Instruction" stage allows the applicant the opportunity to become familiar with, and train in, the school bus vehicle. Student transport is **not permitted** at this point. A "supervising driver" who holds a valid licence and has held a minimum Full Class 5F driver's licence for at least three years, of which two years are the same class of licence being taught or operated, must accompany the "trainee" (applicant). The supervising driver must be in the seat nearest the driver, have less than .05 blood alcohol concentration, and cannot fail a drug-screening test.

## **4. Road Test**

To complete the final stage of acquiring a Class 2F driver's licence for the purpose of operating a school bus, a school bus vehicle will be required. The first step of the road test is to perform a pre-trip inspection of the school bus vehicle. The second step is the road test itself, at which time you will be evaluated (tested) on your ability to safely operate the vehicle.

**NOTE . . .**

Failing the pre-trip inspection will automatically cancel the road test portion of the testing. Fees for the road test are not refundable if the test is cancelled due to the vehicle failing to meet vehicle standards under *The Highway Traffic Act* and its Regulations.

For more information on driver testing refer to the MPI Professional Drivers Manual, contact MPI as indicated below, or visit a driver-testing centre.

**Manitoba Public Insurance**

Telephone: 204-985-7000

Toll free: 1-800-665-2410

**Manitoba Education Requirements**

If you intend to drive a school bus for a school division in Manitoba, or secure employment through a contractor that supplies drivers to Manitoba school divisions, you will be required to obtain a School Bus Operator's Certificate in addition to holding a Class 1F or Class 2F driver's licence. The Pupil Transportation Unit, issues this Certificate.

Two separate clauses in Manitoba Regulation 465/88R outline the requirements for new school bus driver.

***The Public Schools Act Manitoba Regulation 465/88R***

***Requirements of driver***

***15***      *The driver of a school bus shall*

*(i) obtain a school bus operator's certificate from the office of the Pupil Transportation Unit of the Department of Education before operating a school bus carrying passengers;*

***Driver instruction***

***18 (1)***    *The school board shall ensure that*

*(a) each new school bus driver receives a minimum of 24 hours of instruction in school bus driver training prior to operating a school bus carrying passengers;*



The minimum 24 hours of instruction required to obtain a School Bus Operator's Certificate is offered through school divisions and by school bus contractors. The training, which focuses primarily on the Manitoba School Bus Driver's Handbook, the MPI Driver's Handbook, and the Professional Driver's Manual, is conducted by School Bus Driver Instructors who have been certified by the department. The 24 hours of training will focus on:

- General school bus knowledge;
- Instruction for performing a thorough and effective pre-trip inspection;
- In-vehicle and behind-the-wheel instruction.

Once the individual is familiar with the school bus vehicle, they will be scheduled to write/perform the following MPI tests at an MPI Service Centre:

- a written Class 2 knowledge test;
- a written school bus knowledge test; (also known as a class 8 test)
- a pre-trip inspection (failing a pre-trip inspection automatically cancels the road test);
- a road test in a school bus vehicle (road test fees are non-refundable if the test is cancelled due to failure of the vehicle to meet standards under *The Highway Traffic Act* and its Regulations).

Upon successful completion of all requirements, the new school bus driver will receive a Class 2F driver's licence from MPI, and a School Bus Operator's Certificate from PTU.

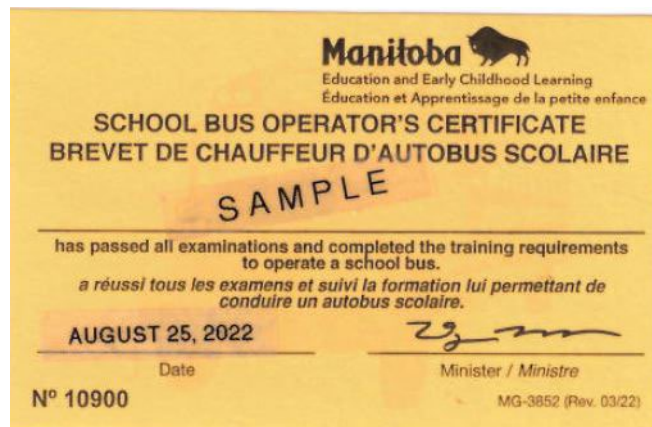

### **Becoming a School Bus Driver for a Manitoba School Division/School Bus Contractor if a Class 1F or Class 2F Driver's Licence is Currently Held**

While holding a Class 1F or 2F driver's licence indicates an individual has previously met all MPI requirements for that class of licence, the department requires that an applicant complete a minimum of 24 hours of instruction focusing on operation of the school bus vehicle. This instruction is offered through school divisions and school bus contractors and is conducted by School Bus Driver Instructors who have been certified by the department. Instruction includes general school bus knowledge, performing pre-trip inspections, observation time in-vehicle, and behind-the-wheel training. The applicant will be tested on their understanding of the training received. Upon successful completion of the department requirements, the new school bus driver will receive a School Bus Operator's Certificate from PTU.

## Annual In-servicing

The department also requires that school divisions and contractors provide annual eight hours of in-servicing to certified school bus drivers:

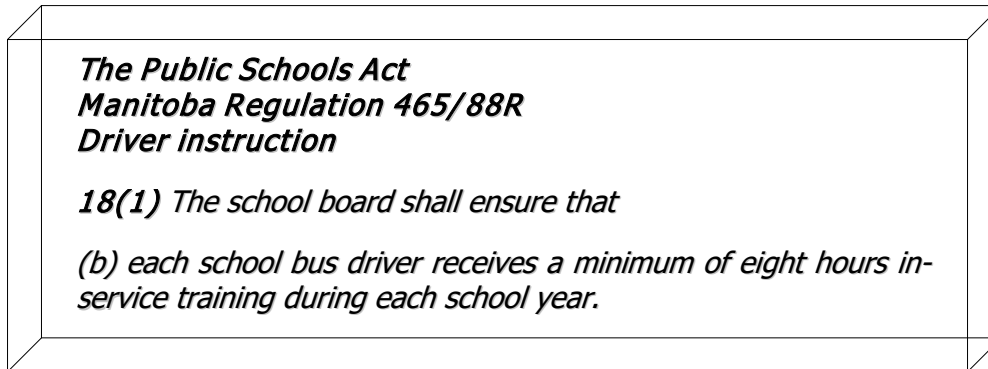

## DRIVER RECORD (ABSTRACT)

A driver's abstract may be required for employment or legal purposes. Potential school bus drivers can obtain a copy of their driver's abstract by applying at any MPI Service Centre or Autopac agency and paying the required fee. If the employer requests an abstract, written permission from the individual must be obtained before an employee's, or potential employees, driving record will be released.

Two types of driver's abstract exist:

- a non-commercial driver's version (those holding a Class 5F driver's licence).
- a commercial driver's version. This version includes infractions committed under commercial driver legislation and regulations (e.g., a commercial driver is charged with the vehicle being overweight, or the log book was found to be out of date). The commercial driver's abstract affects an employer's safety fitness rating. Under the National Safety Code, a motor carrier's safety fitness rating is affected by the driving offences of its employees. This information will help a motor carrier decide how an employee's, or potential employee is, driving record will affect the employer's safety fitness rating.

## MANITOBA'S GRADUATED DRIVER LICENCING (GDL) PROGRAM

As of April 1, 2002, drivers applying for their first Class 5 driver's licence must participate in the Graduated Driver Licensing (GDL) Program, and are subject to the program's stages and restrictions. The stages include:

- ♦ L – Learner Stage (minimum 9 months) (supervising driver must be a fully licenced driver for at least 3 years and have under .05 blood alcohol content).
- ♦ I – Intermediate Stage (minimum 15 months) (a driver is only required to complete the Intermediate Stage once. Therefore, time served in the Intermediate Stage in Class 6 will be applied to the Intermediate Stage in Class 5).
- ♦ F – Full Stage.

**The GDL program does not apply to:**

- ♦ drivers holding a full class 5F licence for at least 36 months who want to learn to drive a Class 1, 2, 3, or 4 vehicle.
- ♦ drivers who held a licence of any class (1 to 6, or 7) or stage before April 1, 2002.
- ♦ experienced drivers whose licence is changed to a learner stage due to a test failure.
- ♦ experienced out-of-province drivers who are required to take full driver examination upon transferring to a Manitoba driver’s licence. Class 5 or 6 drivers in the Learner or Intermediate stages are issued “Authorized Instruction” status, and are subject to zero blood alcohol content.

For more detailed information: please visit [www.mpi.mb.ca](http://www.mpi.mb.ca).

**COMMERCIAL DRIVERS**

**Canada/U.S. Medical Reciprocity For Commercial Drivers**

Canada and the United States implemented a new medical reciprocity agreement for operators of commercial motor vehicles. This agreement was a result of discussions between Transport Canada and the United States Federal Highway Administration to achieve reciprocity between the two nations on medical fitness for operators of commercial motor vehicles. The agreement streamlines the flow of goods between Canada and the United States, in keeping with the North American Free Trade Agreement.

**Commercial Driver’s Licence (CDL) – United States**

A Manitoba Class 1, 2, 3 or 4 driver's licence is acceptable as a Commercial Driver's Licence (CDL) in the United States. Certain medical conditions may prohibit a driver from operating a commercial vehicle there; these drivers will have a “Code W” restriction placed on their commercial licence. The Federal Motor Carrier Safety Administration (FMCSA) requires that you must be 21 years of age and carry a completed medical card. The FMCSA also requires operators of commercial motor vehicles, including two-axle heavy truck with a gross vehicle or gross combination weight of 4,536 kg or more, to have medical certification when operating in the United States. Drivers operating in the United States will have to participate in a drug and alcohol testing program administered by their employer. FMCSA regulations apply to businesses that operate commercial motor vehicles in the United States and their drivers are required to have a CDL.

For more information on commercial driving, contact:

Manitoba Trucking Association  
 25 Bunting Street, Winnipeg, R2X 2P5  
 Telephone: 204-632-6600  
 Website: [www.trucking.mb.ca](http://www.trucking.mb.ca)



U

N

I

T

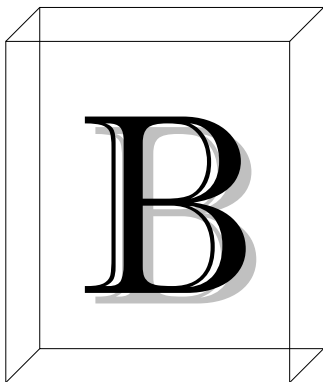

---

**PUPIL RELATIONS:  
MANAGEMENT AND  
DISCIPLINE**

# **PUPIL RELATIONS: MANAGEMENT AND DISCIPLINE**

You, as a school bus driver, are the first contact students have outside of home in their daily activities; your attitude may influence their conduct for the remainder of the day.

You must retain passenger control at all times in order to avoid distractions. It is important for you to be aware of general behaviour patterns for various age groups of students, and that you understand how to apply techniques of discipline.

In cooperation with school officials and parents, you are responsible for the safety of the students who ride your bus. To keep them safe, you must be able to control them, as well as the bus, not only during the ride but during the loading and unloading process.

## **LOADING AND UNLOADING**

School bus accident data indicates that passengers are more likely to be fatally injured or injured during the loading and unloading process than during the bus ride. For this reason, proper procedures for loading and unloading a school bus must be carefully examined and strictly followed.

You must learn proper procedures for controlling traffic; assisting passengers who must cross a roadway; loading and unloading passengers; and proper seating of students.

### **Loading Procedures**

1. Pupils must be loaded only at designated bus stops approved by the school division. Student loading zones in rural areas should be on the extreme right side of the road where visibility is clear for a minimum of 150 metres/500 feet. In urban areas, the bus stop should be located mid-block where visibility is clearest.
2. Pupils should wait a reasonable and safe distance from the outer edge of the road or pavement at the approved bus stop.
3. Reduce the vehicle's speed and gently apply the brakes to bring the bus to a controlled stop. Check your outside rear view mirrors and allow immediate traffic to pass.
4. Simultaneously activate the amber warning lights a minimum of 90 metres/300 feet before the loading zone (which warn other motorists that the school bus is about to stop), signal your intention to move to the right, and check for traffic approaching from the front and rear.
5. Approach students with extreme caution, considering to their location and the road surface (e.g. dry, slippery, dips sharply to the right, rough ground).
6. Move to the extreme right side of the road as far as practical and stop. This procedure will eliminate the hazard of a vehicle passing on the right while loading passengers.

7. Do not stop closer than one metre/3 feet (2 metres/6 feet if conditions permit) or a safe distance from the waiting students.
8. When the bus comes to a complete stop, place transmission in neutral and keep the service brakes applied.
9. Check to ensure traffic has stopped. On buses equipped with a manual service door control handle, move the handle 5-8 centimetres (2-3 inches) to activate the red warning lights, stop arm, crossing arm, and exit lamp (if equipped). On buses equipped with air or electric doors, press the "open door" switch to activate the red warning lights, stop arm, crossing arm, and exit lamp.
10. The school bus driver is responsible for the safety of students when they are required to cross a roadway. In order to achieve maximum safety, the driver must supervise the crossing and maintain control at all times. Students who must cross a roadway to reach their designated bus stop should stand on the opposite side of the roadway from the bus stop, and wait for the bus to stop. After receiving a signal from the bus driver, students should check for traffic and cross the roadway at least 3 metres/10 feet in front of the bus beyond the extended crossing arm.
11. Do not tolerate crowding or pushing as students enter the bus. Students must use the handrail.
12. Seat students according to school division policy. A seating plan is advisable as it can assist a driver in getting to know students, and to manage a discipline problem. It is advisable to work with the school principal and supervisor when developing a seating plan. Appendix B1 includes two samples, which may assist in developing a seating plan.
13. Ensure that all students are properly seated, and then close the service door. This will automatically cancel the red warning lights, stop arm, crossing arm, and exit lamp (which will go out five seconds after closing the service door, or as the bus starts to move).
14. Do not put the bus in motion until everyone is seated. Students must remain seated while the school bus is in motion.
15. **Double check the danger zones around the bus by checking all mirrors.** (Refer to the diagram on the following page.)
16. Using the mirrors, check for traffic; activate the left turn signal to indicate your intent to pull out into traffic, and proceed to the next stop.

**For various turnaround procedures while loading/unloading see appendix D4.**

# HOW TO CROSS THE ROAD SAFELY

DANGER FROM PASSING CARS

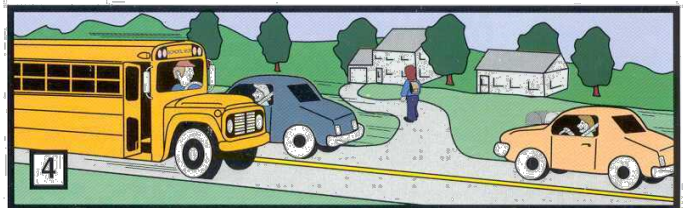
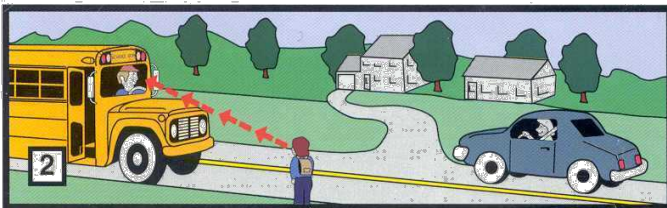
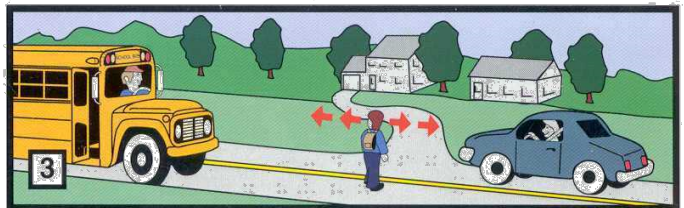
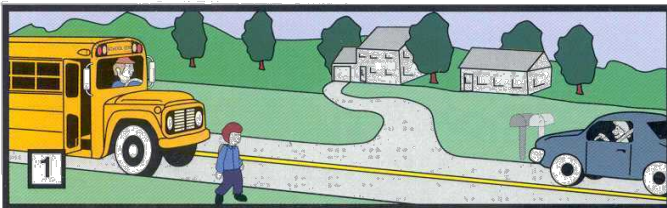
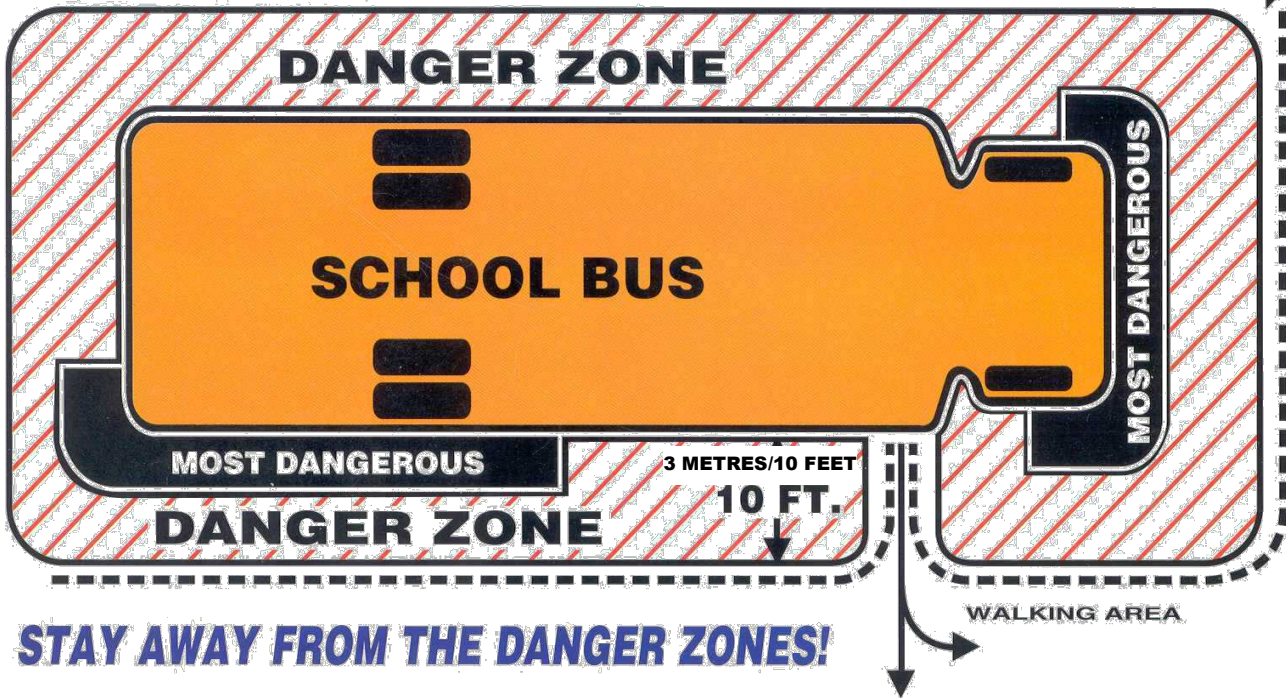



## Unloading Procedures

1. Before stopping to unload passengers, check the outside rear view mirrors to assess the traffic situation. Reduce the vehicle's speed and gently apply the brakes to bring the bus to a controlled stop.
2. Activate the amber warning lights a minimum of 90 metres/300 feet before the stop, signal your intention to move to the right, and check for traffic approaching from the front and rear.
3. Move to the right side off the road as far as practical and stop.
4. When the bus is stopped, place the transmission in neutral and keep the service brake applied.
5. On buses equipped with a manual service door control handle, move the handle 5-8 centimetres (2-3 inches) to activate the red warning lights, stop arm, crossing arm, and exit lamp (if equipped). On buses equipped with air or electric doors, press the "open door" switch to activate the red warning lights, stop arm, crossing arm, and exit lamp. Check traffic approaching from the front and rear. If traffic presents a hazard, keep students on the bus. Do not allow students to exit the bus until traffic in both directions has stopped.
6. Students should remain seated until the service door is fully open, then use the handrail provided to exit the bus. Instruct students to move quickly away from the bus. **Keep track of the number of students getting off the bus and ensure they have all reached a safe location.**
7. The school bus driver's responsibility to oversee students' safety when they are required to cross a roadway cannot be overstated. In order to achieve maximum safety, the driver must supervise the crossing and maintain control at all times. Upon exiting the bus, students should walk along the edge of the road until they are at least 3 metres/10 feet in front of the bus, beyond the extended crossing arm. Students should then proceed to the left front side of the bus, stop, and look both ways to ensure that traffic has stopped and that it is safe to cross the roadway. Upon receiving the signal from the bus driver, that it is safe, students should check traffic again and proceed across the roadway.
8. A school bus crossing patrol can be used effectively to assist the school bus driver with controlling a roadway crossing. However, when no patrol is available, a driver may find it necessary to leave the driver's seat in order to ensure a safe crossing. Check with your supervisor to ensure you know how to properly secure the vehicle.
9. Do not permit passengers to leave the bus at stops other than their assigned stops. Check local policy.
10. Do not move the bus until departing students have reached a safe location.
11. **Double check the danger zones around the bus by checking all mirrors.** (Refer to the diagram on the previous page).
12. Using the mirrors, check for traffic; activate the left turn signal to indicate your intent to pull out into traffic and proceed to the next stop.

## THE SCHOOL BUS DRIVER AND STUDENT PASSENGERS

To be a good school bus driver you need a general knowledge of your passengers. It is advisable to learn the names of each passenger.

Your main objective is to transport your passengers to their destination safely. To do this, you must know something about your passengers' behaviour patterns.

Effective communication is a valuable tool. It is imperative to communicate effectively with your passengers. Parents and students recognize an orderly and well-managed bus. They may not tolerate a driver who does not maintain passenger discipline.

### STUDENT CONDUCT

***The Public Schools Act Manitoba Regulation 465/88R  
Passenger behaviour***

***13 (1)*** *The principal of a school whose pupils are being transported in the school bus has the same disciplinary authority over the conduct of the pupils during the period in which they are in, entering upon, or alighting from the school bus, as is provided by the regulations under The Education Administration Act.*

***13 (3)*** *The driver of a school bus shall report to the principal any misconduct of pupils while entering, leaving, or being conveyed in a school bus under that driver's charge.*

### Passenger Behaviour

Student management should be sufficient to ensure the following procedures are observed at all times:

- ◆ Pupils must enter and leave the school bus at loading areas and bus stops in an orderly fashion and in accordance with instructions. This requires due regard for their own safety and the safety of others. Pupils will therefore proceed without rushing, crowding, or pushing.
- ◆ Pupils must not distract the driver. In general, any activity that worries or distracts you as a driver is objectionable. You need to concentrate on driving and traffic situations. Distractions can create unsafe situations. Pupils must show due consideration for you and your driving responsibilities by exhibiting orderly behaviour.
- ◆ Pupils must cross a roadway in accordance with loading and unloading procedures.

- ◆ Pupils must not destroy property. Transportation equipment represents a large capital investment. Pupils are expected to cooperate in its maintenance and preservation.
- ◆ Pupils must not extend arms or other parts of the body out of windows. Windows should not be opened without your permission.
- ◆ Pupils should not be allowed to eat while riding the school bus since choking on food is a real possibility. Check and support local school division policy.
- ◆ Pupils must not throw objects inside the bus or out the windows. Waste paper and other refuse must not be scattered along the roadway. The aisle must be kept clear; books and other belongings should be held by students or properly stored under the seats.
- ◆ Pupils must be on time at bus stops both at home and at school. They should leave home in time to reach the bus stop five minutes before the scheduled pick-up, and avoid playing or loitering on the roadway when waiting for a bus. Procedures for walking on the roadway should be made clear to pupils. Check local school division policy and instructions to parents regarding ridership rules.

List of rules and regulations covering pupil behaviour and expectations will be prepared by the school division, and is distributed to pupils and parents. The active co-operation of parents can be very helpful. A general list of safety rules for students to follow while riding the school bus is presented in Appendix B2.

## **PASSENGER SAFETY AND CARRY-ON ITEMS**

School bus interiors are designed to provide each passenger with maximum protection. The seatbacks and padding provide each child with a non-hazardous environment. This method of protection is called the "compartmentalization concept" and does not require active participation by passengers in order to deliver a high level of protection. Carry-on items, however, can jeopardize this safety feature.

Section 4 of Manitoba Regulation 465/88R is meant to protect passengers by prohibiting the transport of hazardous items on the school bus.

***The Public Schools Act Manitoba Regulation 465/88R  
Standards and specifications***

***4 Each school bus registered under The Highway Traffic Act in the name of a school board, and each school bus that is under contract with a school board, shall conform to standards and specifications as follows:***

***(k) no school bus, while transporting pupils, shall be used to carry any animal, firearm, explosive, flammable liquid, or anything of a dangerous or objectionable nature, or any article likely to endanger the safety of the passengers.***

Carry-on items are restricted to those that can be safely managed by each passenger in their assigned seating place. Check with your supervisor regarding local policy for carry-on items.

## COMMUNICATING WITH YOUR PASSENGERS

Effective communication with passengers must be conducted calmly. You must be careful when talking with students, and never threaten them.

Remember to give instruction to pupils without showing favouritism. If you overlook the misconduct of one student, you lose the respect of the others. You must have a responsive attitude, being neither too lenient nor too harsh, since both extremes will have an effect on the morale of the pupils on the bus. Your attitude should be professional at all times.

Student management should start the first day of the school year. Rules should be made very clear and offenders dealt with promptly. It is much easier to prevent a bad situation than correct one.

Strive to build the morale and cooperation of your passengers. This can be done by being friendly, courteous, and helpful. Peer pressure can aid a driver in controlling difficult situations. When pupils discover that improper conduct is not acceptable to the group, offenders will hesitate to do things which cause them to "lose face" with their peers. Remember the following:

- ◆ Do not grant special privileges to individual students.
- ◆ Observe the rights and privileges of each student only as long as the ridership rules are adhered to. The moment a pupil "gets out of line", deal with the offender fairly, impartially, and in the same manner, you treat all such offenders. In the eyes of students, the greatest sin an adult can commit is to "play favourites".
- ◆ Remember that all eyes are on you while you are driving the bus. Your words and actions have tremendous influence on students riding your bus. Speak quietly, clearly, and with confidence and firmness when talking to students.
- ◆ Be liberal in your praise of the group when they accept responsibility and have a general pattern of good behaviour. Do not single out individual students for praise before the group.
- ◆ Do not attempt to handle serious discipline situations yourself. Refer all such issues to the school principal and your supervisor. Provide all the facts and be sure the entire problem is clearly understood. Often the pupil who causes the problem on the bus is also causing problems in the classroom. The school administrator has the complete picture of the child, while you, as a bus driver, know only school bus behaviour.

An example of a School Bus Misconduct Report form can be found in Appendix B3. Become familiar with the form used by your school division. Ask your supervisor and school principal to explain its use.

## **BULLYING**

School bus drivers must be familiar with their schools' codes of conduct. *The Public Schools Act*, Section 47 outlines what a school's code of conduct must include; Section 58.10 identifies students' responsibilities (see Appendix B4).

### **NOTE . . .**

**Bullying on the school bus must be addressed immediately. In most cases, it is best to report such incidents to the school principal and your supervisor.**

## **CHARACTERISTICS OF STUDENT BEHAVIOUR**

### **Kindergarten and Elementary School Pupils**

Kindergarten and elementary school children require a great deal of physical activity, and talking is often used as a substitute for this physical activity. While loud talking on a bus is a problem that requires much patience on the part of the driver, absolute silence among pupils is not a healthy school bus atmosphere. Students vary in the amount of activity required and their behaviour will vary from day to day. Prompt and continued action should be the rule applied to all infractions of school bus conduct.

Younger pupils are inclined to disregard the feelings of adults, yet tend to be sensitive of what adults think of them. They are also sensitive to the opinions of other children. It is the responsibility of each driver to ensure that no passenger suffers because of the actions of other passengers.

The characteristics of this age group often make it possible to promote group spirit; "to make our bus the best". Many bus drivers have excellent results by discussing bus rules with the pupils and having them thought of as "our rules". Some drivers develop a game of having each busload of students attempt to have the cleanest bus, be the best behaved on the bus, or the most orderly when loading and unloading. This method requires considerable skill, and drivers should consult their supervisor before attempting to start this type of competition.

### **Secondary School Pupils**

Young adults may be involved in personal relationships that extend onto the bus. The school bus driver must intervene if explicit physical contact or verbal comments are being exchanged. A change in the seating plan may help, but if the situation continues, it should be reported to the school principal.

## Elements of Group Psychology

**Group Troublemakers.** High school age pupils have a tendency to organize in groups. Most groups comprise similar backgrounds, and are formed primarily for imagined protection or are prompted by some pupils who aspire to positions of leadership. Any action against one of the group member becomes an action against the entire group. If a group member refuses to go along with the majority, the group may dismiss the member.

The best way to deal with this type of bus behaviour is to ask that members of the group be assigned different seats or to ride on several different buses, or that bus riding privileges be denied to all members of the group until they agree to abide by the rules. If the main troublemaker can be readily identified, it may be advisable to take action against that person only. Often the group will fall apart when their leader is no longer among them. Follow procedures prescribed by your local school division.

**Group Leaders.** On every bus there will be pupils who, through athletic, scholastic, or social activities, become leaders. They do not actively work at leadership, but other pupils naturally agree with what they might suggest or the manner in which they act. Their leadership is usually good, and it is important for the bus driver to know who these pupils are and to encourage their leadership qualities.

## Techniques of Group Control

- ◆ If an individual student is guilty of breaking the rules of bus conduct, do not reprimand the student in front of all the pupils riding the bus. Individual behaviour problems which do not affect others on the bus are best handled privately.
- ◆ On the other hand, if one or more pupils threaten the safety of all school bus passengers, a driver should point out the misbehaviour in front of everyone. An example of this would be the lighting of matches by students riding the bus. The student(s) responsible should be dealt with when the incident occurs and in front of everyone on the bus.
- ◆ After a few weeks at the start of the school year, you will be able to identify any troublemakers on your bus, often by the way other students act toward them. If incidents you encounter do not endanger the safety of other passengers, avoid confrontation with the troublemaker in front of other students. It is best to report an incident to the school principal and supervisor and ask for their help in the matter.
- ◆ Young people resent more than anything else, the appearance of real or imagined favouritism on the part of the driver towards a particular student(s). It is easy to be lenient with normally well-behaved pupils and harsh toward those who have been giving trouble, but the driver must remain impartial.
- ◆ Never lose your temper. In the event of an argument or misunderstanding, the driver should remember that the less emotion displayed, the less emotion is likely to be aroused on the part of the student.
- ◆ Young people like to test adults; see how far they can go, or how much they can get away with. Behaviour, which is obviously in this category, should be dealt with firmly, but fairly.

- ◆ Firmness should not be confused with harshness or unfriendliness. Many experienced drivers have driven for years without experiencing serious disciplinary issues. The secret is to let passengers know what is expected, to insist on reasonably good behaviour at all times on the school bus, and to avoid creating unnecessary difficulties.
- ◆ As per local school division policy, each student should be provided with a copy of the rules for good bus behaviour. In addition, the principal, supervisor, bus driver, and parents are to be familiar with the rules. It is often desirable for the principal to have an assembly of all pupils riding the bus to discuss and explain these rules. The bus driver should strictly enforce every rule in a fair and impartial manner.
- ◆ Do not gossip with students.
- ◆ Do not reprimand everyone on the bus for the mistakes of a few.
- ◆ Have a friendly, but professional relationship with students.

### **The School Bus Driver and Pupil Cooperation**

Passenger behaviour on the school bus will be one of the major challenges confronting you as a school bus driver.

You are responsible for the conduct of pupils on your bus, but you have the backing of school administration so that this responsibility can be effectively discharged. In cases of continued misconduct, report the pupil to the school principal and supervisor (using a School Bus Misconduct Report form) and ask that consideration be given to withdrawing the pupil's riding privileges.

Normally, the first action taken (depending on school division policy) could be a reprimand or withdrawal of bus privileges for a short time, usually a week. If pupil behaviour does not improve, privileges can be withdrawn indefinitely. This is usually done only after all other measures have failed to improve the situation.

Obviously, you cannot be solely responsible for proper pupil behaviour. All rules and regulations concerning pupil behaviour need to be known and understood by administration, teachers, parents, bus drivers, and pupils. However, you must, of course, accept responsibility for enforcing the rules and regulations.

In case of a serious infraction of the rules, use the following guidelines:

- ◆ Stop the bus in a safe place. The fact that you have taken this action makes the pupils realize the situation is unacceptable.
- ◆ Speak to the offender(s) firmly.
- ◆ If a change in seating is required, the pupil(s) should be moved to a seat near you so that their behaviour can be more closely monitored.
- ◆ You cannot put a pupil off the bus except at their assigned bus stop. However, before denying the pupil transportation, check with your supervisor or school principal regarding proper procedures.

## **DO'S AND DON'TS**

### **Do's**

- ◆ Always be courteous to students.
- ◆ Always control your temper.
- ◆ Act the part of a person in a responsible position, conscious of your important job.
- ◆ Stress repeatedly to students that they have important responsibilities to ensure group safety.
- ◆ Maintain close contact with school principals and seek their cooperation.
- ◆ Report incidents of bullying.
- ◆ Spot troublemaker(s) and, if you are uncertain, ask the school principal what methods to employ.
- ◆ Seat troublemaker(s) near you, within your vision.
- ◆ Be firm, but fair.
- ◆ Be consistent.
- ◆ Maintain a friendly, but professional relationship with students.

### **Don'ts**

- ◆ Avoid physical contact with students (i.e. as physical force, or as a method of consoling)
- ◆ Don't be too lenient.
- ◆ Don't tolerate bullying of any kind.
- ◆ Don't gossip with students.
- ◆ Don't threaten.
- ◆ Don't shout.
- ◆ Don't argue.
- ◆ Don't use profanity.
- ◆ Don't attempt to handle serious discipline problems while the bus is in motion.
- ◆ Don't hold a grudge.
- ◆ Never assume everything is alright.
- ◆ Avoid general statements directed at everyone when restoring order on the bus.
- ◆ Don't publicly question a school division decision. Make suggestions for improvement to the proper authority.
- ◆ Never put a student off the bus for misconduct while on route. (School divisions are responsible for a student's safety to and from school.)



U

N

I

T

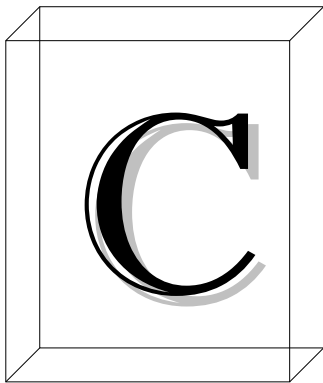

**PREVENTIVE  
MAINTENANCE**

# PREVENTIVE MAINTENANCE

In order to ensure that a school bus is in safe mechanical condition, a driver must perform a daily inspection prior to transporting passengers. An adequate pre-trip inspection and completion of the school bus inspection log book will ensure a safe vehicle as well as provide a record of inspections, defects, and repairs. An important purpose of the log book is to ensure communication between the driver of the school bus and the service technician responsible for repair of the vehicle.

As the primary operator of a school bus, a driver is in the best position to evaluate the condition of that vehicle and to report any defects found. The driver must report a defect to proper personnel. Describe what you see, hear, smell, and feel. Remember, defects cannot be repaired if they are not reported to appropriate personnel.

It is the responsibility of every school division to ensure that every school bus vehicle in its fleet is equipped with a school bus inspection log book, and to ensure that every driver completes the records and reports as required.

The school bus inspection log book contains detailed instruction regarding its completion and provides a detailed pre-trip inspection checklist. This pre-trip checklist is presented in Appendix C1 and can be used as a reference while performing your pre-trip inspection.

It is important to recognize that every school bus driver is required to inspect and record defects prior to operating their school bus each day. When defects are found that could interfere with safe vehicle operation or are in violation of *The Highway Traffic Act*, the vehicle cannot be operated for transporting students until repairs are completed and the log book is signed and dated by the service technician completing the repairs.

When a defect is identified that is not safety-related, the record would show the defect and would be reported according to local school division policy. The service technician completing the repairs would sign and date the log book on the day the repairs were completed.

When inspecting your school bus you will find it useful to have several cloth or paper wipers, a source of artificial light, and some glass cleaning fluid. Paper wipers aid in checking fluid levels and in cleaning windows and mirrors.

It is important to note that the law requires a pre-trip inspection. Section 318.2 of *The Highway Traffic Act* states:

***The Highway Traffic Act  
Safety inspection and reports by drivers***

*318.2 A person must not drive or tow a regulated vehicle on a highway unless*

- (a) every vehicle driven or towed has been inspected in accordance with the regulations;*
- (b) reports have been prepared and submitted at the times and in the manner and to the persons prescribed by regulation; and*
- (c) every vehicle driven or towed has been found to be in safe operating condition.*

Additionally, requirements under Section 15 of Manitoba Regulation 465/88R include:

***The Public Schools Act  
Manitoba Regulation 465/88R  
Requirements of driver***

***15 The driver of a school bus shall***

- (a) have a valid driver's licence to operate a school bus vehicle;*
- (b) be competent to operate the vehicle under his or her charge;*
- *(c) determine the safe condition of the school bus by daily inspection and immediately report any defect to the school board;*
- *(d) comply with all the requirements in The Highway Traffic Act and these regulations;*
- (e) make such reports, and complete such records and forms as are required by the school board;*

A school bus driver must perform a pre-trip inspection of a school bus vehicle prior to transporting passengers. The law requires one daily (24 Hour period) pre-trip inspection as a minimum. However, if a different driver will operate the same school bus, the new driver must perform a pre-trip inspection and complete the school bus inspection log book accordingly. As an example, if a school bus vehicle is inspected by a driver prior to the morning route and the same bus is driven by a different driver during the course of the day, the new driver must perform a pre-trip inspection. When the regular driver returns to drive the afternoon route with the same bus, the regular driver must inspect the school bus again and complete the log book prior to transporting passengers. When drivers complete the school bus inspection log book, they are documenting the fact that they have inspected their vehicle and have found it safe or otherwise. In other words, the person driving the bus must be the same person who inspected the bus and signed the school bus inspection log book.

## UNDER-THE-HOOD CHECKS

The first set of checks is made under the hood while the engine is cool and the various fluid systems have had time to stabilize.

- ♦ **Check the oil level.** Engine oil level must be checked daily and maintained within the crosshatch marks or between "Add" and "Full". The vehicle must be parked level. (Under no condition should an engine be operated with insufficient oil as this could cause internal engine damage.) Do not overfill. Use the oil approved by your school division.

Some engines may hold 25 litres of lubricant or more. This large volume of oil will expand or contract greatly depending on engine temperature. A cold engine's dipstick may indicate a lower reading than the same engine at operating temperature. Engine manufacturers recommend checking the oil level at operating temperature after a 15-minute shutdown. This method will provide the most accurate reading. School bus drivers must learn the "safe" cold oil level for their school bus because they are required to check the oil level prior to start-up. This may be determined by checking the oil level 15 minutes after parking a warm bus (afternoon route) and then checking the oil level again after it has completely cooled down (morning) to compare the difference. Driver knowledge of this difference will prevent over-filling of the engine crankcase.

- ♦ **Check the radiator.** Inspect the condition of the radiator and hose connections for seepage stains that indicate leakage. Also, the coolant level inside the radiator should be checked daily. On newer radiators, this is done by ensuring there is coolant in the overflow tank through a "site glass" on the metal type of tank, or by viewing the level through a translucent tank. On older radiators, the radiator cap must be removed in order to check the coolant level. CAUTION! To prevent loss of coolant and avoid being burned, coolant level should be checked or coolant added only when the engine is cool. When the engine is at normal operating temperature or above, the internal pressure built up in the coolant system will blow out scalding fluid and vapour if the radiator cap is suddenly removed.
- ♦ **Check all drive belts.** Visually inspect belts for cracking, looseness, or breakage. A loose alternator belt can cause the battery to lose power and lights may not operate. Belt tension can be checked in the following manner: with the engine off, apply light finger pressure to the belts at a point midway between the pulleys. As a general rule, belt deflection should not exceed approximately one-half inch. If the belts squeal when the engine is started, report the defect in accordance with school division policy. On buses with a serpentine belt (wide flat), inspect the drive belt for looseness, fraying, cracks, alignment, and foreign material in the small grooves.
- ♦ **Check the power steering fluid level.** It must be maintained at the "full" level.
- ♦ **Check** that the brake fluid is at a safe level.
- ♦ **Check** that the windshield washer fluid is at an adequate level.
- ♦ With tilt, hood vehicles, before closing the hood, check the steering wheel lash from the driver's seat using the following procedure:

On vehicles equipped with power steering, visually and manually inspect with the engine running. With the front wheels in a straight ahead position, turn the steering wheel until turning motion can be observed at the front wheels; then, turn the steering wheel in the opposite direction until motion can be observed at the front wheels. Estimate the amount of steering lash (total movement observed at steering wheel rim before movement at front wheel).

<b>Total movement must not be greater than shown below:</b>	
<b>Steering Wheel Diameter</b>	<b>Steering Lash</b>
Less than 300 mm ( 12" )	45 mm ( 2" )
350 mm to 400 mm ( 14-16" )	50 mm ( 2" )
400 mm to 450 mm ( 16-18" )	55 mm ( 2.5" )
450 mm to 500 mm ( 18-20" )	60 mm ( 3" )
Larger than 500 mm ( 20" )	87 mm ( 3.5" )

- ◆ Vehicles with a non-tilt hood, the front wheel movement may be observed by extending your head through the driver's side window. View the left front wheel while turning the steering wheel in the opposite direction until motion is observed at the left front wheel; estimate the amount of steering lash (total movement observed at steering wheel rim before movement at front wheel).
- ◆ Although they may not be located under the hood, check the batteries in the battery compartment to ensure cable connections are clean and tight, and that the batteries are secure.

**NOTE . . .**  
**See Post-Trip Preventive Maintenance Procedures for checking automatic transmission fluid level on page 36.**

## **INSIDE-THE-BUS CHECKS**

The second set of checks takes place inside the bus from the driver's seat.

- ◆ Driver compartment inspection. To drive the vehicle safely you must position yourself so that you are able to reach and operate the controls and see all areas around the bus.
- ◆ Adjust the seat so that your path of vision directly ahead and to either side is not obstructed; your hands can grip the steering wheel and operate controls comfortably and easily. Seat height should be adjusted to allow easy reach of the accelerator and brake pedal.
- ◆ Check the windshield and side windows in the driver's compartment for obstructions and cleanliness.
- ◆ Check all mirrors to ensure they are clean and adjusted so that all areas around the bus

are visible from the driver's seat. The interior rear view mirror should provide a good view of passengers and the area directly behind the driver. The outside rear view mirrors should provide a view beyond the right and left rear of the bus. The fender-mounted crossover mirrors (convex mirrors) should provide a clear view of the areas directly in front of the bus. The crossover mirrors are properly adjusted when you can see the area in front of the vehicle immediately ahead of the front bumper, along both sides of the front wheels, and the service door area.

- ◆ School buses manufactured after March 1998 are equipped with System "A" and System "B" mirrors in accordance with Canadian Motor Vehicle Safety Standards (CMVSS 111). Appendix C2 outlines mirror adjustment requirements in accordance with CMVSS 111. School divisions in Manitoba have also been provided with a video entitled *A Better View*, which explains CMVSS 111 mirror adjustment procedures.
- ◆ Latch the driver's seat lap and shoulder belt. As a way of protecting passengers, the seat belt must be worn at all times. In the event of a skid or swerve, a buckled-up seat belt will keep you from being thrown out of your seat and allow you to control the vehicle. Check condition of the webbing, buckle, and retractor.
- ◆ As of 2008, school buses must be equipped with a seat belt cutter, which is to be located within reach of the driver when secured in the driver's seat.
- ◆ Check all emergency equipment. The first aid kit must be sealed. If the seal is broken, contents must be counted and brought up to the required standard. The school bus inspection certificate requires that inspectors install a breakaway seal on the first aid kit box lid. If the seal is broken, the kit may not be complete. Only shop personnel or emergency equipment suppliers are authorized to reseal first aid kits. Check that the gauge on the fire extinguisher registers in the charged area. Also check that the fire axe/crow bar, triangular reflectors, and seat belt cutter are in place.
- ◆ The neutral safety switch applies only to vehicles equipped with automatic transmissions. The neutral safety switch is part of the starter motor electrical circuit and does not allow the engine to start when the transmission is in gear. To test the neutral safety switch, place the gear selector in "D" (Drive) or "R" (Reverse), apply the service brake, and turn the key to start. Nothing should happen. Now, place the gear selector in "N" (Neutral) and turn the key. The engine should start.
- ◆ To start vehicles equipped with diesel engines and glow plugs or air intake heaters (under normal conditions): turn on the ignition key - a "Wait-To-Start" indicator lamp will light up on the dash. When the light goes off, turn the ignition key to engage the starter and release the key the instant the engine starts. A special feature of the solid-state glow plug system is its instant recycling ability. If the switch is turned off, the operator can immediately recycle the system by turning the ignition switch on. This will start the reheat cycle of the glow plugs/air intake heater and the "Wait-To-Start" light will come on. This process can be repeated several times in extremely cold temperatures. Appendix C3 outlines engine starting and warm-up procedures.

- ◆ Gauge checks. Once the engine has been started, check all gauges: oil pressure, fuel, temperature, voltmeter, ammeter, and air pressure. These tell you the condition of the engine and electrical system. Due to differences in buses and gauges, it is not advisable to establish generally acceptable gauge readings. Instead, it is important that each school bus driver be familiar with the normal gauge readings for the vehicle assigned.
- ◆ The oil pressure gauge should indicate adequate oil pressure; that is, within the pre-determined range established for your bus. Note: If your bus is equipped with an oil pressure warning light in addition to the oil gauge, it may go on as the bus is being started, but should go off right after the engine starts. If it remains on, shut off the engine and report the problem immediately.
- ◆ The temperature gauge indicates the temperature of the coolant in the engine. After first starting the engine, the temperature gauge should read "Cold" and move slowly to mid-dial as the engine warms up. If the gauge reads "Hot" or the temperature warning light comes on, shut off the engine and report the problem. Running or restarting an overheated engine can cause adverse engine effects such as piston scoring or engine seizure. Therefore, let the engine cool off before operating it. CAUTION! Do not remove the radiator cap of an overheated engine. The steam and hot coolant could injure you.
- ◆ The automatic transmission temperature gauge allows the driver to monitor the transmission fluid temperature. Abnormal readings should be reported to service personnel as soon as possible.
- ◆ The ammeter gauge indicates whether the alternator is charging. An ammeter showing discharge after the engine is running indicates a problem in the charging system and needs to be reported.
- ◆ The voltage meter or voltmeter indicates voltage produced by the alternator. A reading of 13 to 14 volts with the engine running is normal. The voltmeter also indicates battery condition. Battery condition is checked with the key in the "On" position. A reading of approximately 12.5 volts is normal.
- ◆ Large school buses are equipped with hydraulic power brake system. The power brake assistance is provided through a hydraulic booster at the master cylinder. There are three items to check to ensure the system and back-up system are functioning as designed: the brake pressure warning light, a buzzer, and the electric hydraulic pump motor.
- ◆ Check operation of the entrance door control and latch. On buses with automatic doors, press the "open door" switch and check that the doors open completely without binding or jerking. Close the entrance door and check that the door seals mate properly.
- ◆ Check inside the bus passenger area. With the engine running, park brake on, and service door closed, activate the amber warning lights. Check the indicator and operation of the flashing lights. Walking to the rear of the bus, check the seat cushions for security and damage. Open the emergency exit door and check latch operation, hinge operation, warning buzzer, door retainer, and door seal. This door must operate easily to allow passengers to exit in the event of emergency. Check operation of the rear amber warning lights and close the emergency exit door. Walking to the front of the bus, check the side windows for defects or damage. Check operation of the emergency exit windows and roof hatches. Are the hinges free, buzzers working, and latches

operational? Return to the driver's seat. Turn on the headlights, dome lights, and clearance/marker lights. Turn on individual heater motors checking high and low speeds. Note any odd sounds or deficiencies. Activate the windshield washer; turn on the windshield wipers and check all speeds. Keep fluid on the glass to prevent scratching.

- ◆ As previously mentioned, school buses manufactured after March 1998 are equipped with System "A" and System "B" mirrors in accordance with Canadian Motor Vehicle Safety Standards. An assistant may be required to check the front amber warning lights if they cannot be viewed in the front crossover mirrors.
- ◆ Check the dome lights, dash lights, dash gauges, horn, signal, and high beam indicator. Leave headlights on high beam and activate the left turn signal. Open the service door to activate the alternating red warning lights, stop arm, crossing arm, and exit lamp (if equipped). Check the stop arm indicator light on the panel; note indicator operation; ensure the crossing arm and stop arm are deployed.

The chart on the following page lists safety checks to be completed inside the school bus. Once performed, continue your pre-trip inspection by performing outside-the-bus checks.

**REMEMBER . . .**

**In addition to the school bus inspection logbook, the following documents must be present in the school bus vehicle:**

- **Vehicle registration**
- **School Bus Inspection Certificate issued by Manitoba Public Insurance Vehicle Standards and Inspections**

**NOTE . . .**

**If your school bus is equipped with a manual transmission, see Preventive Maintenance Checks in Appendix C4.**



## Inside-the-Bus Checklist

	Steering wheel
	Driver's seat; seat belt
	Gear shift lever
	Windshield/windshield wipers/windshield washer
	Heaters; defrosters
	Horn
	Headlights; daytime running lights
	Directional signals
	Driver's side window
	Mirrors
	Stop arm control
	Crossing arm control
	Neutral safety switch
	Emergency equipment – first aid kit; fire extinguisher; fire axe/crow bar; triangular reflectors; seat belt cutter (see illustration below)
	Gauges – oil pressure; fuel; water temperature; voltmeter; ammeter; alternator; air pressure; automatic transmission temperature
	Hydraulic brake system
	Park brake
	Service door control and latch
	Rear emergency exit – latch operation; hinge operation; warning buzzer; door stop strap; door retainer; door seal
	Amber warning lights; red warning lights
	Interior lights – dome; dash; stepwell
	Side windows
	Emergency exit windows and roof hatches
	Passenger seat condition
	Bus cleanliness
	Brake pressure warning light; buzzer; electric hydraulic pump motor

### NOTE . . .

**In order to provide service personnel with as much time as possible to correct defects, it is suggested that a post-trip inspection be performed immediately following completion of a route.**

### ILLUSTRATION – SEAT BELT CUTTER



## **OUTSIDE-THE-BUS CHECKS (Walk-Around Inspection)**

The diagrams on pages 32 and 33 illustrate the outside-the-bus checks to be made.

- ◆ Start your walk-around inspection at the right front corner of the bus. Ensure the inspection decal is valid. Carry a cloth to wipe mirrors, windows, and light lenses. Mirrors and side windows should be cleaned, and mirrors adjusted as necessary. Check the right front wheel rim and lug nuts for signs of looseness. Streaks of rust or a shiny/sometimes-blackened area at the lug may indicate looseness. If in doubt, check it with the wheel wrench and report the findings to maintenance personnel. Visually check the right front spring and linkage for breakage; tire pressure should be checked weekly. Wheel nuts, lugs, rims, and tires are very important to the safe and economical operation of a school bus vehicle. Give them the attention they deserve. Don't drive on a damaged wheel. Develop the habit of observing the tires for abnormal wear patterns, and check for under-inflation by bumping with a hammer or tool provided. Report any noticeable tire wear. Take hold of the crossover mirror bracket to ensure it is securely anchored.
- ◆ Next, move to the front of the bus around the extended crossing arm and check the headlights, high beam, clearance and park lights, left turn signal, warning lights, and stop arm. Is the school bus sign clean and the lettering visible? Does the windshield require cleaning? If so, be careful not to damage the wiper blades. Do not manually operate the wiper arm since this action will damage the wiper mechanism.
- ◆ Moving to the left front corner of the bus, take hold of the crossover mirror bracket to ensure it is securely anchored. Check the left front wheel rim, wheel lugs, lug nuts, and tire as previously described. Make a visual check of the steering box and linkage. Are there any leaks? Is the linkage tight? Also visually check the left front spring. Are the spring shackle pins in place? Does it appear to have a broken spring leaf?
- ◆ Moving back along the left side of the bus, check the stop arm, and strobe light. Are the lights on the stop arm flashing? Is the sign clean and legible? As you move down the bus, check the side windows and the bus body for defects or damage.
- ◆ Next, check the left rear wheels for adequate inflation by bumping with a hammer or tool provided. Make certain there are no under-inflated or flat tires. Check tire pressure weekly. Never drive the bus with one dual tire flat. A flat tire will heat up and destroy itself, creating a hazardous situation. Visually check the left rear suspension for problems. Check the wheel lugs and lug nuts. Watch for tell-tale signs of looseness.
- ◆ At the rear of the bus, check the tail, clearance, licence plate, and left turn signal lights. Clean the lenses. Check all decals to ensure they are clean and legible. Open and close the emergency exit door from the outside. During winter months, ice build-up on the rear of the bus could freeze the emergency door shut. Remember that a young student may need to open the emergency door. Clean all rear windows and check the exhaust pipe for leaks and security.
- ◆ Check operation of the rear door retainer device by opening the rear door to the fully open position. The device should hold the door at a 90-degree angle to the bus body.

Moving the door to its retainer limit again should disengage the opening device and allow the door to close.

- ◆ Move to the right side of the bus. Check the side windows and body for defects and damage. Check the right rear wheels by bumping with a hammer or tool provided lug nuts, and suspension as on the left side. As you move forward, check under the bus for telltale signs of an exhaust leak (i.e. exhaust vapour or hissing sound). Check the fuel tank for leaks, security, and filler cap.
- ◆ Go inside the bus and check the stepwell light and entrance floor area. Move into the driver's seat, cancel the stop arm, and warning lights, switch the headlights to low beam, and the signal lever to the right signalling position. Using a pre-manufactured rod, lightly wedge the brake pedal enough to activate the brake lights. Make a second circle tour of the bus. At the right front, check the right signal light, front low beam headlights, and under the front of the bus for oil or antifreeze leaks. Noting the colour of a leaking substance will give you a clue as to what is leaking. Move along the left side of the bus to the rear, checking as you go.
- ◆ At the rear of the bus, check the brake lights and right turn signal. Move forward along the right side of the bus and enter the bus to turn off the headlights (leave the engine running). Activate the hazard warning lamps. Move to the front of the bus and check operation of the daytime running lights, as well as the front hazard warning lamps. Circle the bus to check the rear hazard warning lamps, and return to the driver's seat. Cancel unnecessary lights and equipment.
- ◆ Finally, from the driver's seat, perform a hydraulic brake system check as follows:
  1. Ensure the brake warning indicator does not stay on continually when the service brake is applied (park brake released).
  2. With the engine running, test the brake pedal reserve (on vehicles with power brakes). Apply and maintain moderate foot force to the pedal for one minute. The pedal should not move towards the floor more than 65%.
  3. Apply the park brake and with the engine running at an idle and the transmission engaged, attempt to move the vehicle. The park brake must hold the vehicle.
  4. On vehicles with electric motors (brake assist): With the engine stopped, apply moderate pressure to the brake pedal. The electric motor operation should be audible.
  5. Move the vehicle forward and apply the service brake. Ensure the vehicle stops.

Once you have completed the entire pre-trip inspection (i.e. under-the-hood checks, inside-the-bus checks, outside-the-bus checks, and completed the school bus inspection log book), you are ready to buckle up and have a safe trip.

## OUTSIDE-THE-BUS CHECKLIST (WALK-AROUND INSPECTION) – FRONT AND REAR

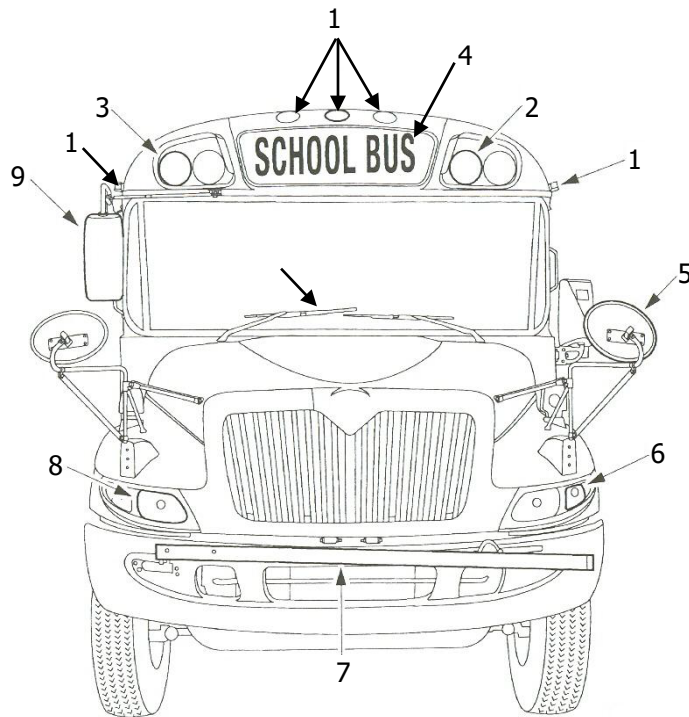

- 1) Clearance/markers
- 2) Amber warning lights
- 3) Red warning lights
- 4) School bus identification sign
- 5) Crossover mirrors
- 6) Turn signals/park lights
- 7) Crossing arm
- 8) Headlights/daytime running lights
- 9) Rear view mirror

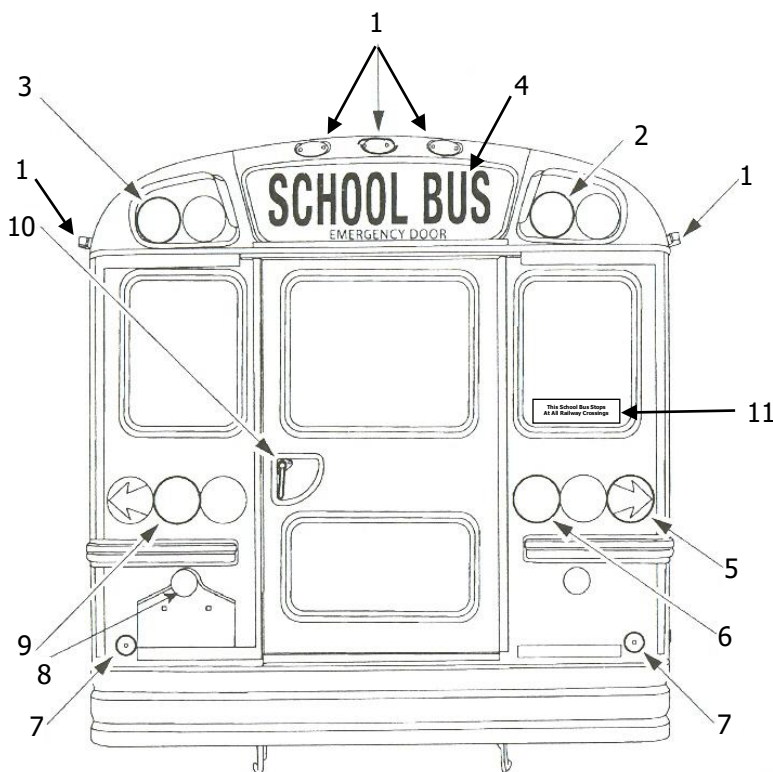

- 1) Clearance/markers
- 2) Amber warning lights
- 3) Red warning lights
- 4) School bus identification sign
- 5) Turn signals lamps (with/without arrows)\*
- 6) Back-up lights
- 7) Reflectors
- 8) Licence plate light
- 9) Stop/tail lights
- 10) Emergency door handle
- 11) Railway crossing decal

\*Hazard warning lamps are a function of the turn signal lamps.

## OUTSIDE-THE-BUS CHECKLIST (WALK-AROUND INSPECTION) – LEFT SIDE

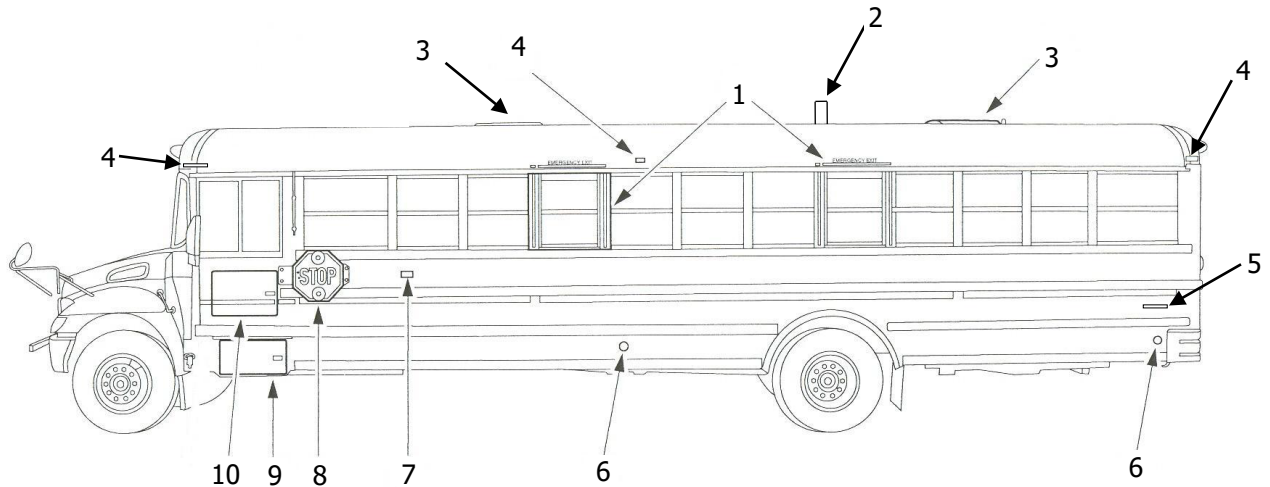

- |                                |  |
|--------------------------------|--|
| 1 Emergency exit windows       | 6 Reflector                            |
| 2 Strobe light                 | 7 Side mounted turn signal lamp        |
| 3 Emergency roof vent/hatch    | 8 Stop arm                             |
| 4 Side marker lamps            | 9 Battery compartment                  |
| 5 Floor level side marker lamp | 10 Electrical compartment access panel |

### NOTE . . .

- ♦ The opposite side view would show the service door and fuel tank filler.
- ♦ Although not shown on the diagram, reflective tape is required on the sides and rear of newer school buses.

## **BUS CLEANLINESS – INSIDE AND OUTSIDE**

- ◆ Although students are expected to properly dispose of paper and other refuse, the bus must be cleaned daily. It is particularly important to sweep the bus immediately after completion of the route in winter months so that any melted snow is removed.
- ◆ All windows and mirrors must be kept clean to provide maximum visibility.
- ◆ The outside of the bus should be washed as often as necessary. Do not allow road dirt to accumulate. All school bus decals should be kept clean. From a safety standpoint, a clean yellow bus is more visible and conspicuous to the motoring public.
- ◆ Seat condition should be checked each time your bus is unloaded. By doing so, damage can be identified more effectively and appropriate action taken against vandalism.
- ◆ It is important to the health and safety of the students on your bus to keep it clean and sanitary at all times.

## **PREVENTIVE MAINTENANCE WHILE ON THE ROAD**

The previous section detailed checks to be made before leaving on your run. This section deals with preventive maintenance while on the road and is divided into two parts: detection of abnormal vehicle behaviour and the driver's role in minimizing the damage caused by such problems; and good driving habits that will extend the life of the vehicle and its components.

### **Detecting Abnormal Vehicle Behaviour**

Detection of abnormal vehicle behaviour requires the use of sight, hearing, smell, and feel. As a first step, the driver - while at the wheel - must learn to recognize the normal running condition of the vehicle so that adequate comparisons can be made between normal conditions and strange steering, rattles, odd smells, etc. For this reason, and as a vital safety practice, it is important that the driver, in addition to performing a pre-trip inspection, constantly monitor vehicle performance for different noises and drivability conditions. This is to say that the pre-trip inspection, as well as the monitoring of the vehicle while driving, is the driver's responsibility. Throughout the route, a driver should constantly monitor the gauges and operating condition of the school bus.

Upon completion of the pre-trip inspection, and when ready to begin driving, you should:

- ◆ Apply the park brake. With the engine at idle and the transmission engaged, attempt to move the vehicle. If the bus does not move, the park brake is functioning properly. If the bus does move, the park brake is malfunctioning and the defect must be reported to a service technician for repair.
- ◆ Check the service brakes prior to reaching the roadway. Test at low speed, bringing the bus to a smooth and complete stop. The bus should stop in a straight line without skidding, swerving, or pulling to either side, and without grabbing, locking, or making excessive noise.

- ◆ Check the transmission. Automatic transmissions should not slip or produce harsh, jerky shifts. (On a school bus equipped with a manual transmission, ask your supervisor for the manufacturer’s recommended procedures.)
- ◆ While the bus is moving straight ahead, check the steering mechanism. As with the other checks above, any unusual conditions or noises should be reported at once.
- ◆ Check the suspension to ensure safe control of the bus while on the road. Indications of suspension malfunction are bus sag at one end or one corner, excessive bouncing, and hitting bottom when going over bumps or through potholes. Also, check that the bus tracks properly and does not weave or sway when turning.
- ◆ The final check is of the engine. In addition to periodic gauge checks (especially oil pressure, temperature, and ammeter) listen for unusual engine noise and be alert to poor engine performance.

### **Good Driving Habits**

The second part of the driver's on-the-road preventive maintenance responsibility is proper operation of the vehicle components through good driving habits. Many of the procedures covered in this section will have no immediate effect on the vehicle's operation, but if practiced regularly, will significantly increase the lifespan of vehicle components.

A commonly abused vehicle component is the brakes. For extended brake life on the bus you drive, follow these pointers. By watching the traffic ahead you can observe when you may have to stop or slow the bus down prior (coast) to making a stop. When stopping, use a gentle application of the brakes and reduce pedal pressure as speed drops so that very light foot pressure is used at the end of the stop. Avoid quick, harsh brake applications or applying the brakes for extended periods on downgrades. Both of these actions cause brakes to heat, and excessive brake heat shortens brake life and braking effectiveness. Brake fade can occur if the brakes are used excessively on a long downgrade. Engine or exhaust brakes will help reduce vehicle speed when activated in a downgrade situation.

### **Rear Axle Differential**

For extended rear axle life, avoid spinning the rear wheels on slippery surfaces.

### **Transmission**

Before driving a bus equipped with an automatic transmission for the first time, it is a good practice to consult the owner’s manual for recommended procedures.

**REMEMBER . . .**

**Preventive maintenance while on the road and good driving habits are vitally important to the safe operation and long life of the vehicle. The single-most important preventive maintenance responsibility the driver has is to immediately and accurately report any malfunctions.**

## **POST-TRIP PREVENTIVE MAINTENANCE PROCEDURES**

A driver's preventive maintenance responsibilities are not over until the vehicle is secured by applying the park brake, interior checked and any malfunctions reported to the service department.

After arriving at the parking area, it is your responsibility to ensure the vehicle has adequate fuel for the next trip. In winter, this will reduce the amount of condensation inside the fuel tank.

Limit the time your bus idles during the post-trip inspection. Follow your school division's idling policy. A sample idling policy can be found in Appendix C5 of this handbook.

Before securing the bus, check the interior for sleeping students and for any damage that should be repaired before the bus is used again (e.g. broken windows or ripped seats). Check the exterior of the bus for burned out bulbs or other damage.

Because the engine and transmission are at operating temperature, this is the ideal time to check the automatic transmission fluid level. Use the following guideline.

1. Engine must be running and the park brake applied.
2. Open the hood and remove the dipstick from the automatic transmission filler tube.
3. Wipe the dipstick and fully re-insert into the filler tube.
4. Remove the dipstick and read the fluid level. The fluid level should be in the hot run band on the dipstick.
5. Re-insert the dipstick.
6. If fluid is required, contact your service department for further instructions.

Re-enter the bus, turn off all electrical equipment, shut off the engine, remove the keys, and secure the bus.

The last step is to report all abnormal conditions encountered during the day to the service department.



U

N

I

T

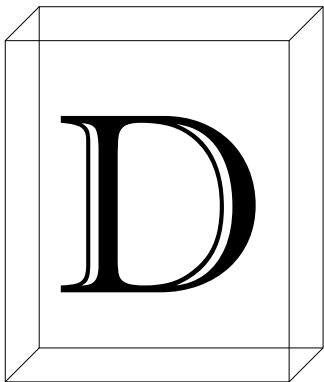

**DRIVING  
FUNDAMENTALS**

# DRIVING FUNDAMENTALS

Passenger safety is the school bus driver's top priority. Learning the skills required to operate a large vehicle will improve your ability to provide maximum protection to your passengers.

Daily inspection of the school bus is the first step in passenger safety. Procedures for inspection were covered earlier in *Unit C - Preventive Maintenance*.

This unit deals with on-the-road driving activities and represents a consensus of best-known practices.

## DRIVING A LARGER VEHICLE

Automobile and school bus operation require similar knowledge of rules of the road and general safe driving habits. However, the skills required to operate a vehicle that is larger and heavier than an automobile need to be learned to ensure passenger safety.

The obvious differences between an automobile and a school bus are the relatively large size and weight of the bus and the number of passengers it transports. The school bus driver must be constantly aware that the bus has a longer stopping distance, slower acceleration, wider turning radius, and requires higher and wider clearances. The average height of a school bus can be 3.2M - 2.8M. In addition, it is important to remember that while the school bus driver sits higher and thus has a better forward view, the driver will have to rely extensively on mirrors to view critical areas around the bus.

While this handbook deals with items specific to school bus operation, when coupled with the *Manitoba Driver's Handbook* and the *Professional Driver's Manual* (both published by Manitoba Public Insurance), sufficient information is provided to drive a school bus vehicle in a safe and efficient manner.

## TRANSMISSIONS

### Manual Transmissions

See Appendix D1 for information regarding:

- ◆ Shifting gears
- ◆ Fuel economy
- ◆ Starting procedures
- ◆ Making right and left turns
- ◆ Stopping in low gear and cruising gear
- ◆ Starting and stopping on hills (upgrades and downgrades)

## **Automatic Transmissions**

On buses equipped with automatic transmissions, know the basic shift positions. Although there are variations, the following procedures generally apply. From a starting position:

1. Depress the service brake.
2. Move the selector lever to the forward or drive position.
3. Release the park brake.
4. Release the service brake and depress the accelerator.
5. As speed of the bus increases, the transmission will automatically shift to the next higher gear until reaching cruising gear.
6. To downshift for additional power, depress the accelerator to the floor firmly. This will cause the transmission to downshift one gear. Then move the selector lever to the next lower position if it is desirable to remain in the lower gear.

## **Fuel Economy**

Avoid quick acceleration and extended engine idling periods to improve fuel economy.

## **STEERING AND TURNING**

As a professional driver, assume the correct steering position and make all turning manoeuvres correctly and smoothly. When you are confronted with an unusual turn or turn-around, exercise extreme caution. The following procedures apply.

### **Steering Techniques**

Grip the steering wheel with both hands, left hand at approximately the 9 o'clock position, right hand at approximately the 3 o'clock position, hands outside of the steering wheel and thumbs on top or inside of the wheel. Larger school buses are not equipped with driver side airbags.

The push-pull steering method is recommended for school bus drivers. One hand pulls and the other pushes. Do not use the hand-over-hand method because you may catch your thumb. If you find the push-pull steering method too slow, you are travelling too fast around the turn. Never palm the steering wheel when driving.

To maintain proper lane position, look ahead and get the "big picture".

### **Rounding Curves**

Judge beforehand whether you will be able to negotiate the curve at your present rate of speed. If it is necessary to brake, do so before entering the curve. Never brake in the middle of a curve as this can cause skidding and loss of control.

1. Decelerate and look ahead for the sharpest point in the curve.

2. Brake, if necessary, before entering the curve.
3. For curves to the right, move close to the centre of your lane and use the width of the lane while rounding the curve, this will help "smooth out" the curve.
4. For curves to the left, enter the curve from the centre of your lane.
5. When you reach the midpoint of the curve, and conditions permit, you may wish to resume speed and accelerate through the remainder of the curve.

### **Making Right Turns**

1. Activate the right turn signal at least 30 metres/100 feet before the turn in urban areas. On highways, signal at least 150 metres/500 feet before turning.
2. Reduce speed as necessary to execute the turn.
3. Position the bus one to two metres to the right edge of the lane/curb.
4. Check traffic signals and/or signs, and watch for pedestrians and vehicles positioned between the right side of the bus and the curb.
5. Check the right mirror and execute the turn smoothly. Enter the right-most lane available and cancel the turn signal. Accelerate and move into the right lane as soon as possible. Remember always signal a lane change.

### **Making Left Turns**

1. Activate the left turn signal at least 30 metres/100 feet before the turn in urban areas. On highways, signal at least 150 metres/500 feet before turning.
2. Reduce speed as necessary to execute the turn.
3. Position the bus to the left edge of the lane. Check for a clear right of way. Vehicles making a left turn DO NOT have the right of way. Check traffic signals and/or signs, and watch for pedestrians and other vehicles. Use both outside mirrors and check especially carefully for vehicles attempting to pass the bus on the left side. If it is necessary for you to stop before making the turn, keep the front wheels straight and the brake pedal depressed. This stopping procedure will prevent your bus from being shoved into the path of oncoming traffic if you are struck from the rear.
4. Check the left mirror and execute the turn smoothly. Enter the roadway in the left-most lane available and cancel the turn signal.
5. After completion of a left turn onto a multiple lane highway, accelerate and move into the right lane as soon as possible. Remember to always signal when making a lane change.

## **STOPPING**

### **Speed, Weight, and Distance**

Stopping a school bus smoothly and within the limits of safety is another requirement. The distance required to stop a vehicle depends on its speed and weight, in addition to energy, heat, and friction. The braking force required to stop a vehicle varies directly with its weight and speed. For example, if the weight is doubled, the braking force must be doubled to be able to stop in the same distance. If the speed is doubled, the braking force must be increased four times to be able to stop in the same distance. When weight and speed are both doubled, the braking force must be increased eight times to be able to stop in the same distance.

For example, a vehicle carrying a load of 14,000 kilograms at 15 kilometres per hour is brought to a stop in 30 metres with normal brake application. If the same vehicle carried 28,000 kilograms at 32 kilometres per hour, it would require eight times the braking force to stop the vehicle in 30 metres. This would be more braking force than the brakes could provide and would increase the stopping distance.

The following chart identifies the weight of school bus vehicles by passenger size:

Passenger Size	Weight in Kilograms / Pounds
48	6,600 kgs / 14,550 lbs
54	7,000 kgs / 15,432 lbs
66	8,000 kgs / 17,636 lbs
72	9,000 kgs / 19,841 lbs
78	9,100 kgs / 20,062 lbs

## Stopping Distances

Before a driver can bring a bus to a complete stop, the need to stop must be recognized (e.g. in an emergency or hazardous situation), and the brakes must be firmly applied. Therefore, reaction distance and braking distance have a direct influence on overall stopping distance.

The following chart lists the approximate reaction, braking, and stopping distances required at various speeds. The second column lists reaction distance, or the amount of distance travelled during reaction time. Reaction time of the average person, that is, the time required for a person to react after recognition of a hazard, is three-quarters of a second (the time it takes to apply the brakes). The third column lists braking distance, or the average distance travelled after the brakes are applied. The last column lists the total stopping distance.

Speed Travelled	Driver Reaction Distance	Vehicle Braking Distance	Total Stopping Distance
16 KPH / 10 MPH	3.35 m (11ft.)	30.05 m (10 ft.)	6.40 m (21 ft.)
32 KPH / 20 MPH	6.71 m (22 ft.)	12.19 m (40 ft.)	18.90 m (62 ft.)
48 KPH / 30 MPH	10.06 m (33 ft.)	28.04 m (92 ft.)	38.10 m (125 ft.)
64 KPH / 40 MPH	13.41 m (44 ft.)	50.29 m (165 ft.)	63.70 m (209 ft.)
80 KPH / 50 MPH	16.76 m (55 ft.)	77.72 m (255 ft.)	94.48 m (310 ft.)
96 KPH / 60 MPH	20.12 m (66 ft.)	112.78 m (370 ft.)	132.90 m (436 ft.)

The total stopping distances shown in the chart can be interpreted as minimum distances that buses should maintain when following vehicles at different speeds. The figures represent distances for dry surfaces, buses with good tires and brakes, and a mentally alert driver. Stopping distance increases when road surfaces are wet, icy, or snow-covered.

### **REMEMBER . . .**

**Stopping distance becomes greater as speed increases. This is a good formula to remember and practice.**

## Stopping a Bus Equipped with an Engine or Exhaust Brake

1. Release the accelerator to allow the engine or exhaust brake (if equipped) to slow the bus down.
2. Apply the brakes gradually until you come to a complete stop.

## ANTI-LOCK BRAKE SYSTEM (ABS)

School buses manufactured after September 1999 are equipped with anti-lock brake systems in accordance with Canadian Motor Vehicle Safety Standards.

An anti-lock brake system is an electronic system that monitors and controls wheel speed during braking. The system monitors wheel speed at all times. If it detects a wheel locking up during a brake application, the system limits brake pressure to that wheel only. This prevents the wheel from skidding and increases vehicle stability and control even in the most adverse situations such as braking on wet or icy roads, through curves, or during lane changes. When driving a vehicle with ABS, apply the brakes as normal to stop in time. When the ABS starts working, do not release the pressure you have applied to the brake pedal. Do not pump the brake pedal. The system automatically applies and releases the brakes up to forty times per second - much faster than you can pump the brake pedal.

It should be noted that ABS-equipped vehicles may have different stopping distances than those described in the *Stopping Distances* chart. It should also be noted that if the ABS warning light comes on and the ABS feature fails to function, the standard foundation brakes will function normally. The ABS warning light should be reported to school bus service personnel immediately.

### **NOTE . . .**

**ABS safety check procedures are provided in the vehicle's operator's manual.**

## EXHAUST OR ENGINE BRAKE

Since 2002, model year diesel powered buses are equipped with an exhaust or engine brake, which is activated by a switch on the dash. When the switch is in the "On" position, the brake will operate whenever the accelerator pedal pressure is released. Applying pressure to the accelerator pedal will disengage the exhaust or engine brake. When driving on slippery roads, the exhaust or engine brake switch should be in the "Off" position in order to prevent a possible skid situation.

**NOTE . . .**

**Exhaust brakes are not considered engine retarders and do not violate municipal by-laws.**

## **WHILE THE BUS IS STOPPED**

If you stop the bus for more than several minutes, turn off the engine to avoid the possibility of exhaust fumes (poisonous carbon monoxide) entering and building up inside the bus. This action will also conserve fuel.

## **BACKING A SCHOOL BUS**

**BACKING A SCHOOL BUS IS ONE OF THE MOST DANGEROUS MANOEUVRES A DRIVER CAN UNDERTAKE. DO NOT BACK UP UNLESS IT IS NECESSARY.** If you must back the bus, the rule is to be sure you know what is behind you. Don't take chances. Sometimes you can't see enough with mirrors. It is better and safer to get out and look, even though it means walking behind the bus. By doing so, you may prevent a serious accident. If possible, it is advisable to have someone stationed behind the bus where they are safely out of the way but can see you, warn traffic, and act as your guide.

*The Public Schools Act  
Manitoba Regulation 465/88R  
Passenger behaviour*

*13(4) Except with the permission, and under the supervision, of the principal of the school or another person assigned by the principal for the purpose, no driver of a school bus shall back the school bus on school grounds.*

## **STOPPING AT A BUS STOP**

Most fatal accidents involving students being transported to and from school on a school bus occur at the bus stop, either prior to loading, while loading, or students being dropped off. The school bus driver must use extreme caution when approaching and prior to leaving bus stop and must ensure that other motorists are stopping until it is safe for students to proceed.

Be aware of the danger zones around your school bus – the areas, which cannot be readily seen by the driver. Use the outside convex mirrors on the school bus to allow viewing of the danger zones. Always be aware of the location of students when loading and unloading.

## FLASHING WARNING LIGHTS

School buses in Manitoba are equipped with two amber and two red flashing lamps at the front and rear of the bus, this is known as the **"eight lamp warning system"**. Motorists approaching a school bus displaying flashing red warning lights and stop arm, from either the front or rear, must stop no less than 5 metres/16 feet from the bus and must remain stopped until the bus driver turns the lights off. On a divided highway separated by a physical barrier, motorists are not required to stop when meeting or passing a school bus on the opposite roadway. Note that a double solid line does not qualify as a physical barrier.

## "DON'T PASS LAW" VIOLATIONS

"Don't pass law" violations are dangerous situations where an approaching vehicle passes a stopped school bus that has its red warning lights flashing and stop arm extended as it loads or unloads passengers. This is a particularly dangerous situation for children who must cross the roadway to access or leave their appointed bus stop.

If an approaching vehicle presents a potential hazard to passengers, keep them on the bus until it is safe to unload. Do not count on the other driver to prevent an accident. Approach each stop and passenger crossing with caution and anticipate that approaching traffic may not stop, therefore presenting a hazard to passengers crossing the roadway.

All school buses in Manitoba are equipped with a pedestrian crossing arm. The crossing arm activates in conjunction with the red warning lamps and stop arm. The crossing arm extends 2 metres/6 feet in front of the bus on the right side, and forces students to cross in front of the bus where the driver can maintain eye contact with them. Some buses may be equipped with a cancel switch to bring in the crossing arm when not required. For example; in bus loops.

It is important that your school division's ridership training program include information on the dangers of "don't pass law" violations and how to defend against them. Students must be instructed, to cross 3 metres/10 feet in front of the bus (beyond the length of the extended crossing arm and where the driver can maintain eye contact with them). Then, walk the width of the bus, stop in line with the left side of the school bus, and cross the roadway only when the driver signals it safe for them to cross. Students should continue to exercise caution as they make their way across the roadway.

If you experience a "don't pass law" violation, try to obtain the licence plate number of the offending vehicle. Make note of the time of day, and location of the violation. Report the occurrence to the proper authorities immediately following completion of your route. A "Don't Pass Law" Violation Report form can be found in Appendix D2.

*The Highway Traffic Act* requires that ALL traffic stop for school buses displaying flashing red warning lights on the front and rear of the bus.



## **THE HIGHWAY TRAFFIC ACT**

### **Motor vehicles approaching stopped school bus displaying signals**

*137(2) Subject to subsection (3), the driver of a vehicle approaching a school bus from the front or the rear must bring the vehicle to a stop not less than five metres from the school bus and must not pass the school bus if any of the following equipment on the school bus required under the regulations is operating:*

*(a) one or more flashing red warning lamps;*

*(b) a warning system on the school bus indicating to approaching drivers that they must stop.*

### **School bus on divided highways**

*137(3) Subsection (2) does not apply to the driver of a vehicle on a roadway that forms part of a divided highway if the school bus is located on a different roadway of the same highway.*

A decal can be found in the rear window of many Manitoba school buses warning motorists of the potential penalties of passing a stopped school bus with red warning lights flashing and stop arm activated.



Because of the potential tragedy a “don’t pass law” violation could cause, it is extremely important that each driver and passenger recognize the hazards, understand the defence, and act in time.

## **LOADING AND UNLOADING AT SCHOOL**

Many schools have a designated school bus loop for students to board and depart from the bus, other schools may only drop off and load students on local streets. Regardless of the location where students are picked up or dropped off, the red warning lights and stop arm must be activated during the procedure.

Subsection 137(1) of *The Highway Traffic Act* states:

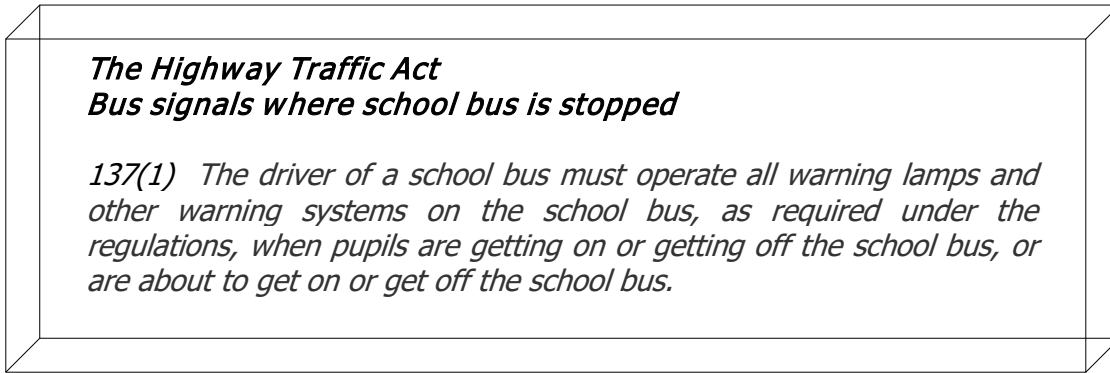

The only exception to this requirement occurs when school bus evacuation drills are conducted. Drills should be held in restricted off-street areas such as dedicated school bus loops or parking lots where vehicle traffic is restricted.

## **LOADING AND UNLOADING PROCEDURES ON ROUTE**

This section provides a condensed version of the procedures required to safely load and unload students onto and off the school bus. A comprehensive list of procedures to follow can be found in *Loading Procedures* and *Unloading Procedures*.

### **Loading Procedures**

When approaching the designated route stop, begin to slow the bus a minimum of 90 metres/300 feet from the stop under ideal road conditions. Simultaneously,

- ◆ Activate the amber warning lights.
- ◆ Signal intent to pull to the right by activating the right turn signal.
- ◆ Lightly apply the brake to activate the brake lights, further indicating intent to stop.
- ◆ Release the brake pedal.

Check mirrors for approaching traffic and pull to the right when safe to do so. Brake the bus to a smooth stop at a safe location a minimum of one metre/3 feet (preferably 2 metres/6 feet if conditions permit) from the students standing in line ready to board. Make this approach very carefully; if the students are not properly organized for loading, stop further away.

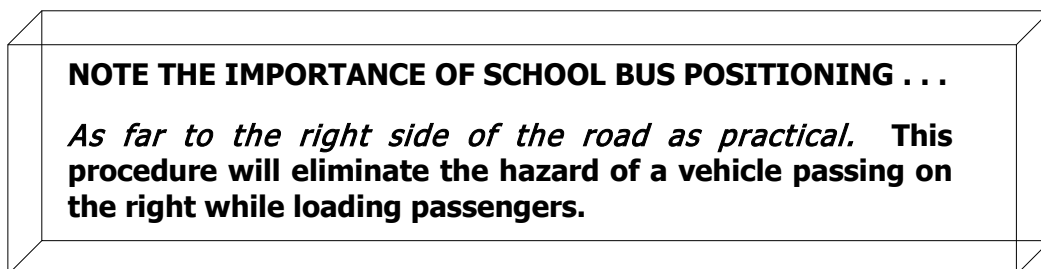

When the bus is stopped, place the transmission in neutral and keep the service brakes applied. On buses equipped with a manual service door control handle, move the handle 5-8 centimetres (2-3 inches) to activate the red warning lights, stop arm, crossing arm, and exit lamp (if equipped). On buses equipped with automatic doors, press or rotate the "open door" switch to activate the red warning lights, stop arm, crossing arm, and exit lamp.

Check to ensure traffic has stopped. Waiting passengers should not move toward the school bus until the service door is fully open.

Student(s) must use the handrail during loading procedures. Student(s) must go directly to their assigned seats in keeping with the seating policy of the school division, and must remain seated in a forward position while the school bus is in motion.

Check to ensure students are properly seated; check the danger zones around the bus; close the service door. Ensure the latch is locked on manual door systems. This will automatically shut off the flashing red warning lights and cancel the stop arm and crossing arm. The exit lamp (if equipped) will shut off approximately five seconds after closing the door, or as the bus starts to move.

Once traffic has cleared, activate the left turn signal and check for students in the danger zones. When safe, pull out into the traffic lane, cancel the left turn signal, and proceed to the next stop.

## **Unloading Procedures**

When approaching the designated route stop, begin to slow the bus down a minimum of 90 metres/300 feet from the stop under ideal road conditions. Simultaneously,

- ◆ Activate the amber warning lights.
- ◆ Signal intent to pull to the right by activating the right turn signal.
- ◆ Lightly apply the brake to activate the brake lights, further indicating intent to stop.
- ◆ Release the brake pedal.

Check mirrors for approaching traffic. Bring the bus to a smooth stop at the designated location.

Again, remember to position the bus as far to the right side of the road as practical to eliminate the possibility of a vehicle passing on the right while unloading passengers.

When the bus is stopped, place the transmission in neutral and keep the service brakes applied. On buses equipped with a manual service door control handle, move the handle 5-8 centimetres (2-3 inches) to activate the red warning lights, stop arm, crossing arm, and exit lamp (if equipped). On buses equipped with automatic doors, press the "open door" switch to activate the red warning lights, stop arm, crossing arm, and exit lamp.

Check all mirrors to ensure traffic has stopped. If no traffic presents a hazard, open the service door. Students to remain seated until the service door is fully open, then use the handrail to exit the bus. Instruct students to move quickly away from the bus. **Keep track of the number of students getting off the bus and ensure they have all reached a safe location.**

When students must cross a roadway, they should be advised to:

- ◆ Walk along the edge of the road until they are approximately 3 metres/10 feet in front of the school bus where the driver can see them beyond the extended crossing arm.
- ◆ Then, walk the width of the bus and stop in line with the left side of the bus.
- ◆ Remain in this position until the driver signals it safe to proceed.
- ◆ Check traffic again, and then proceed across the road.

Once all departing passengers have reached a safe location, close the service door. This will automatically shut off the red warning lights, stop arm, and crossing arm. The exit lamp (if equipped) will shut off approximately five seconds after closing the door, or as the bus starts to move. Once traffic has cleared, activate the left turn signal and check for students in the danger zones. When safe, pull out into the traffic lane, cancel the left turn signal, and proceed to the next stop.

## **RAILWAY CROSSINGS**

Crossing railway tracks presents the greatest risk of mass casualties and fatalities. There is no excuse for a school bus to be colliding with a train. Remember the old adage, "Stop, Look, and Listen!" Remember, trains always have the right-of-way.

The school bus driver must stop at all railway crossings, whether or not carrying passengers. The driver shall stop the school bus not less than 5 metres/16 feet from the nearest rail of the crossing if the crossing is in a restricted speed area, or not less than 15 metres/50 feet from the nearest rail of the crossing in any other case.

Some school bus vehicles may automatically operate the red warning lamps, stop arm, and crossing arm when the service door is opened. If the school bus you are driving operates in this manner, turn off the warning lamp master control switch before opening the door at a railway crossing. You are not permitted to operate the eight light warning lamp system unless you are loading or unloading passengers.

It should be noted that many buses are equipped with a "noise suppression" switch, which disconnects all non-essential components during a railway stop.

Railway crossing procedures as outlined in *The Highway Traffic Act* can be found in Appendix D3.

**REMEMBER . . .**

**The eight lamp warning system is used only when loading or unloading passengers.**

### **Stopping at a Railway Crossing**

1. Begin slowing down 90 metres/300 feet from the crossing, activate the right turn signal, and depress the brake pedal momentarily to operate the brake lights warning motorists you are coming to a stop.
2. Check the traffic front and rear. When approaching a railway crossing, and where conditions permit, pull to the right off the travelled portion of the road and brake to a smooth stop.
3. Stop the bus not less than 5 metres/16 feet from the nearest rail in a restricted speed area, and not less than 15 metres/50 feet from the nearest rail in any other case.
4. Activate the hazard warning lights.
5. Request complete silence from the passengers, shut off all heaters, fans, etc. or press the "noise suppression" switch if equipped.
6. Place the transmission in neutral, secure the bus by applying the service brake or setting the park brake, and open the service door.
7. Look in both directions along the railway and listen for signals indicating an approaching train.
8. If no train is approaching, close the service door and check the traffic both front and rear. Cancel the hazard warning lights and use the left turn signal to indicate you are pulling back into traffic. Proceed across the tracks quickly. (If driving a school bus with a manual transmission, do not shift gears until you are completely clear of the railway crossing.)

### **If a Train is Approaching**

- ◆ Hold bus position; use the park brake.
- ◆ After the train passes, proceed across the tracks as previously discussed.

### **Multi-Track Crossings**

- ◆ After a train passes, ensure that no train is approaching on another track prior to starting up. A second train may be approaching from the opposite direction.

### **Railway Traffic Control Devices**

When a clearly visible electrical or mechanical traffic control device gives warning of an approaching train, a school bus driver shall stop the vehicle as previously discussed and not proceed while any such signal continues to give warning, unless a police officer or flagman directs otherwise, and that it is safe to cross.

An exception to the above instruction can be found in *The Highway Traffic Act* as follows:

***The Highway Traffic Act  
Proceeding when train is stopped***

*134(7) Despite clause (6)(a), a driver who stops at a railway crossing because an electrical or mechanical traffic control device is signalling the proximity of a railway train may proceed across the crossing if the train is stopped, or is not in close proximity to the crossing, and if he or she can do so safely and without stopping before clearing the crossing.*

## **ENTERING THE FLOW OF TRAFFIC**

You will frequently have occasions to either leave one traffic stream or become part of another, or to cross through a second stream of traffic. In many cases, vehicle movement is determined by multiple factors; timed traffic control signals, merging lanes, regulatory signs, lane markings etc. It also takes good judgement while operating a vehicle on the roadway. Intersections present school bus drivers with the highest potential risk for an accident. When proper procedures are followed, accidents at intersections can be greatly reduced.

### **Important Tips**

- When you intend to turn, activate the appropriate turn signal well in advance of the point of entry. Turn signals use in urban setting to activated within 30m and on highway 150M of the turn.
- Stop at the stop line, before the sidewalk or just prior to the point of entry of the other roadway. Unless you are entering an acceleration lane or yield then stop only if necessary.
- Look to the right and left to determine whether there are vehicles in motion on the road to be entered.
- Yield the right-of-way to vehicles and pedestrians and when safe, accelerate smoothly onto the road, cancelling the turn signal after lane position is established.

### **On-Ramps/Off-Ramps**

Check and re-check the traffic ahead when entering an on-ramp. Specifically, look for vehicles that are slowing down or have come to a complete stop.

When driving on a long on-ramp with an acceleration lane marked with a yield sign, check the traffic ahead, and if practical, allow the vehicles ahead to leave the acceleration lane before attempting to merge. Use the acceleration lane to reach a speed that will allow entering the mainstream of traffic.

When entering the main roadway from an on-ramp that does not have an acceleration lane, it may be necessary to stop if you cannot proceed safely. When slowing down, look through the side window, observe the traffic on the mainstream, and do not proceed until there is a gap sufficiently large enough to permit acceleration and a safe and smooth merge.

When entering an off-ramp, observe the speed of other traffic and adjust your speed accordingly. Watch for other vehicles that are stopping at the end of the off-ramp.

## **Intersections**

A driver must be particularly cautious when approaching or reaching an intersection. A traffic control device, a four-way stop or yield may control the intersection, or, it may be uncontrolled. Always “expect the unexpected” at an intersection as another vehicle may attempt to “run” a red traffic light, or proceed out-of-turn at a four-way stop. A few suggestions to help you safely navigate an intersection include:

- ◆ Observe traffic ahead and from the left and right when approaching and negotiating intersections.
- ◆ From a bus driver’s seat, the outside rear view mirrors can obscure your view of approaching traffic. To assist a better view move your body forward and/or rearward to ensure that the mirrors hide no hazards. (Rock and Roll method)
- ◆ Watch for vehicles that are rapidly approaching an intersection and may be unable to stop or have no intention of stopping.
- ◆ If your vision is obscured (e.g. by buildings, trees, parked vehicles) as you proceed forward from a red light or stop sign, move the bus slowly forward until you have a clear view.
- ◆ At a four-way stop, be observant to who has the right-of-way.

## **LANE USE AND POSITIONS ON ROADWAY**

### **General Guidelines**

- ◆ Remain in one lane for normal driving. Do not obstruct more than one lane by straddling lane marker lines.
- ◆ Use the parking lane for stopping and parking only.
- ◆ Where there is more than one lane of traffic going in the same direction, travel in the lane furthest to the right (not including parking lane) unless you intend to pass or turn left.
- ◆ Drive at a safe following distance from other vehicles (see *Stopping Distances* in the School Bus Driver’s Handbook). Speeds greater than 70kph use the 6-second rule. To measure your following distance between your vehicle and the vehicle ahead use a landmark on the roadway. Once the vehicle in front passes start, counting “1001”, “1002” until you reach “1006” if you have not reached the landmark you are now

following a safe distance. (This works for any speed and should be increased when conditions are not ideal.)

- ♦ Observe and obey centre line markings.

### **Changing Lanes**

- ♦ If you must change lanes, signal your intent, check your mirrors, and look for traffic approaching from the rear in the lane you wish to enter.
- ♦ Ensure that no vehicle is in the blind spot.
- ♦ On multi-lane roadways, look for vehicles in your lane and adjacent lanes about to enter the lane you wish to enter. Note their speeds to ensure you can execute your lane-change manoeuvre.

### **Being Overtaken and Passed**

- ♦ When being overtaken and passed and there is no potential hazard, stay in the right lane and maintain speed.
- ♦ If, for some reason, traffic builds up behind you and a regular stop is not imminent, activate the right turn signal and pull as far off the roadway as possible. Stop and allow vehicles to pass, but do not signal for them to pass. Then activate the left turn signal and resume your position on the road. Always consider, however, that passenger safety comes first.

### **Overtaking and Passing**

You will rarely have to overtake and pass other vehicles on two-way traffic roadway; however, when passing is absolutely necessary, follow these procedures:

- ♦ Observe the traffic ahead and do not pass if any lead vehicle is signalling a left turn, changing lanes, preparing to pass another vehicle, or is passing pedestrians, cyclists, or animals. Wait until your view of the road ahead and behind is clear and an acceptable gap in traffic is present.
- ♦ On a two-lane roadway ensure there is no on-coming traffic, and check traffic signs and road markings to determine if passing is allowed.
- ♦ Check your mirrors; activate the left turn signal and shoulder check. When clear, pull smoothly into the passing lane and cancel the left turn signal.
- ♦ After passing the vehicle, activate the right turn signal and return to the right lane once you have proceeded at least 1½-bus lengths past the overtaken vehicle. Never exceed the posted speed limit.

### **MAKING A TURNAROUND**

When a vehicle is backing up, danger of an accident increases.

Turnarounds are more common in rural areas than urban areas. In a rural area, the route may dictate that the bus return in the direction it just travelled. In urban areas, most



situations allow the bus to proceed around the block or to another street as opposed to turning around.

You have the responsibility to inform your supervisor when a turnaround presents a hazard. In many cases, the turnaround location may be narrower than the roadway you are on. For this reason, backing onto the narrower roadway, driveway, or access is the most efficient. The bus should be clearly visible for 150 metres/500 feet in both directions. The safety of children being loaded or unloaded at a turnaround is of the utmost importance. Students must always be on the bus when executing a turnaround. For various turnaround procedures see appendix D4.

Execute a turnaround in the following manner:

### Loading

- ◆ For student safety, it is imperative to have the student(s) on the bus before performing a turnaround.
- ◆ Follow *Loading Procedures*.
- ◆ Close the service door, cancelling the red warning lights, stop arm, and crossing arm. Allow traffic to clear.
- ◆ Move the bus to a position on the roadway one-bus length ahead of the road, driveway, or access where you will back the bus to complete the turnaround.
- ◆ Check traffic front and rear. Ensure there is a sufficient gap in traffic to permit the backing manoeuvre.
- ◆ Back into the road, driveway, or access using the outside rear-view mirrors.
- ◆ Once the backing manoeuvre is completed and are ready to drive forward, signal your intent to turn and proceed onto the roadway when it is safe to do so.

### Unloading

- ◆ For student safety, it is imperative to have the student(s) on the bus while performing a turnaround. This will expose them to the least possible hazards.
- ◆ Execute the turnaround ensuring there is a sufficient gap in traffic to allow you to proceed safely onto the roadway.
- ◆ Follow *Unloading Procedures* as outlined.
- ◆ Give oncoming traffic adequate time to react to the red warning lights.

#### **NOTE . . .**

**In specific situations, it may be prudent to complete the turnaround procedure before loading or after unloading students. If you are unsure of the safety-related consequences at a turnaround location, discuss the situation with your supervisor to determine the proper procedure.**



U

N

I

T

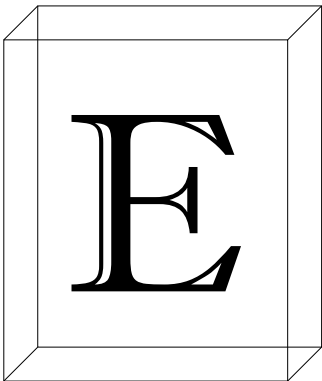

E



**DEFENSIVE  
DRIVING**

# DEFENSIVE DRIVING

Over the years, accident studies have concluded that the leading causes of traffic accidents were mechanical defects, road conditions, and human error, and that 15% of traffic accidents were caused by factors beyond a driver's control.

However, in a more recent study reveals this is not an accurate picture of the real situation. A large percentage of accidents blamed on road conditions are caused by the failure of drivers to properly adjust their driving to road or hazardous conditions. As well, many accidents attributed to mechanical defects are actually caused by drivers who fail to report mechanical defects or fail to ensure repairs are made when mechanical defects are discovered. Consequently, accident investigators now say that 95 to 99 percent of all traffic accidents are due to human error.

The number of traffic accidents attributable to human error could be dramatically reduced through the knowledge and practice of "defensive driving" - a set of procedures and techniques designed to help the driver avoid hazardous situations. There is nothing new or magic about the concept of defensive driving. The formula is simple:

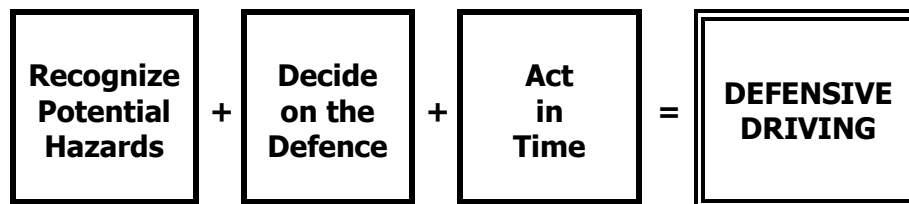

This unit explains how the formula can be applied to a variety of conditions the school bus driver will encounter, including:

- ◆ Driver condition
- ◆ Vehicle condition
- ◆ Adverse weather conditions
- ◆ Man-made conditions

It should be noted that the procedures and techniques for emergency and accident situations (where the driver did not or could not avoid a potential hazard) are covered in *Unit F - Accident Prevention and Emergencies*.

## DRIVER CONDITION

Are you mentally and physically ready to drive? The defensive driver is aware of personal deficiencies and will constantly strive to overcome them.

- ◆ **Knowledge** – Are you familiar with provincial and school division driving rules and regulations, driving fundamentals, emergency procedures, and defensive driving habits? If you have questions, ask before it's too late.
- ◆ **Skills** - If you require practice in driving manoeuvres, operating safety equipment, etc., ask your supervisor for help and practice on your own (in an empty bus, not one loaded with passengers).
- ◆ **Health** –If you are experiencing fatigue, illness, or problems with your eyesight or hearing it may be best that you do not drive. For example, is your depth perception poor? If you are having difficulty judging distance, your eyesight may be the cause. If at any time you are unsure, seek medical advice. Be sure to inform your supervisor of any medical issues you may be experiencing.
- ◆ **Prescription drugs** and over-the-counter medication can cause impairment and affect your vision and judgement. Gain a clear understanding of possible side effects by reading labels on over-the-counter medicines. Ask your doctor about any prescriptions you are taking. Will they affect your ability to perform the job safely?
- ◆ **Attitude** - Personal problems will affect your ability to concentrate on the task of driving a school bus. Emotional strain or fatigue could affect your ability to cope with/control a busload of passengers. It's during these times you may miss stop signs or run a red light, or fail to yield the right- of-way, when, under normal circumstances, these errors would not occur.

Be alert to your attitude. If you are under severe emotional pressure and are unable to concentrate on your driving, or fear that you will be unable to control your temper under stress, do not drive! Under normal day-to-day stresses, your attitude can affect your good driving judgement. You must always be aware of your attitude so that you can be alert. Think positively. Keep yourself under control and your mind on the job at hand.

## VEHICLE CONDITION

*The Public Schools Act  
Manitoba Regulation 465/88R*

*15 The driver of a school bus shall  
(c) determine the safe condition of the school bus by daily inspection and immediately report any defect to the school board.*

## Vehicle Pre-Trip Condition

Is the school bus you are driving in safe operating condition? Will it respond instantly and effectively to all controls? Have you checked it over? Did you report deficiencies and ask your supervisor or maintenance personnel to have them corrected? Your responsibility as a school bus driver is to ensure the school bus is mechanically sound. A checklist is the best way to ensure you have inspected all items. A Pre-Trip Inspection Checklist is available in Appendix C1 of this handbook.

### **REMEMBER . . .**

**Because you are the individual who is responsible to provide safe transportation to students and keep other motorists safe on the roadway, it is imperative that all the school bus mechanical components are inspected thoroughly for the safe operation of the bus. Correct major deficiencies before your run. If you are suspicious about a potential mechanical problem, have it checked. The lives of your passengers depend on your ability to inspect and ensure your school bus is a safe vehicle.**

## Vehicle Condition On-the-Road

Mechanical problems may develop during your run that could create potentially hazardous situations. A defensive driver utilizes their senses to monitor the mechanical operation of the bus.

- ♦ **Sight** - Constantly check gauges for safe readings; watch for dash warning lights; check for fire.
- ♦ **Smell** - Constantly check for telltale odours such as smoke, gasoline or diesel, oil, and burning rubber.
- ♦ **Hearing** – Constantly listen for unusual or abnormal noises.
- ♦ **Feel** - Often the first sign of trouble will be felt. Be alert to loss of power, steering, brakes, transmission failure, tire blowout, etc.

If you identify a mechanical problem during your run, be prepared to act. If you are uncertain as to whether or not the problem constitutes a safety hazard, stop the bus and seek assistance. Do you have phone numbers available? Keep a contact list in your bus.

## ADVERSE WEATHER CONDITIONS

Over the course of a school year, you will face a variety of adverse weather conditions (e.g. ice, snow, mud, fog, bright sun, high winds) that will demand alert and skillful action. These conditions rarely cause accidents; they merely add additional hazards to normal driving. Drivers who do not adjust their driving to meet conditions cause many accidents. Accidents blamed on bad weather conditions, can be mostly preventable.

Driving the same route twice a day for approximately 200 days of the school year will thoroughly acquaint you with your route. However, after a short time you may become complacent. Remember that conditions can change rapidly; potholes develop overnight, grades wash away, shoulders become soft, railway crossing approaches change, loose gravel and rocks can appear, and slippery areas can develop through accumulations of snow, ice, or oil deposits. Each day's conditions will be different and you must be alert to detect them before it is too late. It is of no use to say that an intersection accident occurred because the road was slick. Such an accident happened because the driver failed to adjust to road conditions.

Expert drivers can drive safely on extremely slippery road surfaces by starting on time and by adjusting their driving to conditions. When you must choose between arriving late and driving too fast for conditions, always choose to adjust your speed and schedule.

Here are some suggestions for driving on slippery road surfaces:

- ◆ Switch off the engine or exhaust brake (if equipped).
- ◆ Use windshield wipers when necessary.
- ◆ When driving in adverse road conditions slow down, increase your following distance to allow for greater stopping distance.
- ◆ To avoid being stuck or spinning the wheels, try to keep the bus moving slowly and steadily forward. If the wheels start to spin, let up slightly on the accelerator to allow the wheels to take hold. If the bus stops, do not continue to spin the wheels with the hope of pulling out. This will only dig the wheels in deeper.
- ◆ Drive slower than the speed posted for dry road conditions, especially on bridges and overpasses.
- ◆ When approaching intersections or stopping in icy conditions, pump the brakes once or twice to prevent wheels from locking up on the ice.\*
- ◆ To avoid a skid, do not brake aggressively.\*
- ◆ Make turns smoothly, avoiding application of the brakes.\*
- ◆ Be alert to wet leaves, standing water, or black ice on the roadway. These can be extremely slippery and hazardous.
- ◆ Check brakes immediately after driving through deep water or snowdrifts. If they fail to work properly, apply the brakes lightly while the vehicle is moving to help dry them out.
- ◆ Plan ahead for known areas of the route you expect to be hazardous such as icy bridges, stretches of road that have been slippery in the past, uphill stops, intersections, etc.
- ◆ Do not use cruise control in adverse driving conditions.

---

\* For ABS-equipped vehicles, see in Unit D.

## **Reduced Visibility Due to Rain, Snow, or Fog**

When a driver thinks of adverse weather conditions, remember that rain, snow, and fog will reduce visibility. No matter how good your eyesight is you cannot see as well in these conditions as when the weather is clear. Adjust your driving accordingly and take the following precautions:

- ◆ Keep the windshield clear. If snow or ice builds up on front or rear windows, stop the bus and remove it.
- ◆ Keep headlights on low beam to cut down on glare in dense fog, heavy rain, or snow.
- ◆ Ensure the strobe light on the roof of the bus is flashing.
- ◆ Don't hesitate to leave the roadway at a safe spot to "sit out" heavy rain, snow squall, or thick fog.
- ◆ If your speed is greatly reduced, turn on the hazard warning lights to help make your vehicle visible to other drivers.

## **Reduced Visibility Due to Bright Sunlight or Glare**

While bright sunlight or glare may not be considered adverse weather, it can create serious hazards for motorists. Be prepared. Here are some safety suggestions when driving in bright sunlight:

- ◆ Carry sunglasses and use them when necessary.
- ◆ Wear a hat; the peak will help protect your vision.
- ◆ Adjust visors to block out direct sun.
- ◆ Avoid looking directly at the sun, a bright reflection, or glare as this can affect your vision for several seconds.

## **Reduced Visibility of Night Driving**

The death rate per kilometre driven is three times greater at night than during the day. Despite reduced traffic volume at night, a large percentage of accidents occur at night. Night driving accidents are more frequent, and usually more severe.

Why is it so dangerous? Obviously, it's primarily a matter of reduced vision. Normal eyesight is reduced to 75 percent at night and may be further reduced if the driver has a minor vision disorder.

Even if your eyes could function as well at night as during the day, night driving would still be perilous because of night lighting. Artificial light cannot compare in efficiency to natural light, and the narrow beams of light from headlights give you an automatic case of tunnel vision. Daytime attention-getters such as colours are nearly worthless at night.

You can drive safely at night if you follow pre-trip inspection guidelines and take the following precautions:



- ◆ Change your driving methods at night - don't overdrive your headlights. If you are driving 80 KPH, it will (depending upon your reaction time) take you 95 metres/309 feet to stop. Average headlights illuminate 110 metres/358 feet ahead. Simple mathematics tells you that if something or someone gets in your way, you should be able to stop. At 100 KPH, you will be unable to stop, as you will need more than 110 metres/358 feet to do so. (See *Stopping Distances* in Unit D)
- ◆ Remember that darkness affects depth perception.
- ◆ It takes time for the average eye to adjust to night vision. Drive with special caution during this critical adjustment period.
- ◆ Don't look directly at oncoming lights. Oncoming headlights affect visibility considerably. Staring at oncoming headlights will distort your vision for as long as seven seconds. That is more than 188 metres/611 feet at 90 KPH. Keep your attention on the right side edge of the road.
- ◆ Don't look off into the darkness because your eyes will have trouble re-adjusting to the road lights.
- ◆ Note lane stripes and reflector posts. They form a corridor of reflected light against which a stalled car, pedestrian, or wildlife will show up as a blank spot.
- ◆ Unless you wear sunglasses, try not to drive in bright sun for long periods during the day when you know you must drive the same night. When you do, the time it takes your eyes to adjust to night lighting increases greatly and your night vision will be considerably reduced.
- ◆ Keep headlights on low beam when driving in adverse conditions.
- ◆ When following or overtaking another vehicle, dim the headlights a minimum distance of 60 metres/200 feet from the vehicle.
- ◆ Keep instrument panel lights dim. If too bright, they produce unnecessary glare and distraction.
- ◆ If an oncoming driver fails to dim headlights, don't blind that person by switching on your high beams. That action only creates a hazard to you and your passengers.
- ◆ Don't follow another vehicle too closely. Remember the 6-second rule (see Unit D).
- ◆ Remember that drinking and driving is a factor in many fatal accidents. Be particularly cautious of vehicles being driven erratically. Refrain from consuming alcohol at least eight hours prior to operating a school bus.
- ◆ If it is necessary to stop the bus on the shoulder of the road at night, choose a spot that can be seen for at least 150 metres/500 feet by oncoming and following traffic. Turn off headlights, leave the strobe light and marker lamps on, and activate the hazard warning lights.

## Heavy Wind

While loss of traction and limited visibility are the most commonly faced adverse weather conditions, the driver should also be ready for the potential hazards of heavy wind. As the side of the bus acts like a sail, a strong crosswind at the top of a hill or gusting winds on an open, straight section of road can cause loss of control if the driver is unprepared.

## HAZARDOUS CONDITIONS

Of all the potential hazards facing the school bus driver, hazardous conditions (e.g. road debris or traffic situations) are the most difficult to defend against. Most of the clues to help you recognize potential hazards will be visual, so before examining **WHAT** to look for, it is important to know **HOW** to look.

Suggestions on proper visual surveillance include:

- ◆ Having a clean windshield and properly adjusted mirrors.
- ◆ Always scan around the bus - to the front, sides, and rear.
- ◆ Avoid staring at a particular object, as you will be less aware of clues from your larger field of indirect vision.
- ◆ Focusing 12 – 15 seconds ahead as your speed increases. If your view becomes limited by hills or curves, slow down.
- ◆ Making every effort to see cross-traffic at intersections, even if it means slowing or stopping when your view is obstructed.

The remainder of this Unit pertains to identifying potential hazards by either the environment or human caused conditions and the visual clues to help detect and avoid them.

## Road Hazards

Attention must be given to road terrain and the potential for unseen hazards around curves, over hills, or in dips. By scanning the road ahead, watching road signs, and observing the "lay of the land", good drivers can detect and plan for such changes by slowing to get a better view or to round a curve, and keeping to the right at the crest of a hill.

The second potential road hazard is the road surface. Changes in surface condition could require evasive manoeuvring to avoid a loss of steering or braking control. For this reason, the driver must remain alert. The three most common road surface hazards are:

- ◆ **Rough surfaces.** Watch for surface irregularities such as cracks and potholes in asphalt and pavement, and washboard on gravel roads. On a wooden surface look for holes, bumps, cracks, loose boards, and slippery areas.
- ◆ **Slippery surfaces.** Anticipate the smoothness of asphalt or pavement at intersections or other stopping areas. Recognize areas of a roadway, which are soaked with oil or grease. Remember that the early stage of a rainfall is the most dangerous. Estimate depth and extent of deep water, which partially or totally covers the roadway. When driving on snow or ice-covered roads, judge the effect of traffic and temperature on road surface friction by noting whether other vehicles are skidding. In colder temperatures, approach bridges with caution, as they tend to freeze faster than road

surfaces and reduce steering control. If ice is melting on the roadway, be alert to ice patches near shaded areas (e.g. caused by underpasses or buildings), note spots where direct sunlight may have accelerated melting, and look for additional ice patches ahead on the roadway.

- ◆ **Loose surfaces.** Detect and slow down for loose surfaces such as gravel, soft sand, soft shoulders, and wet leaves.
- ◆ Other potential road hazards may be caused by conditions alongside the road such as the width, surface conditions of shoulders, signposts, guardrails, culverts, or hydro wires. Under normal driving conditions, these should pose no problem; however, they should be included in your scanning as you drive, and evaluated for potential hazards should you suddenly need to leave the roadway.

## **Pedestrian Hazards**

The presence of pedestrians, cyclists, children on skateboards and scooters increases the need for good surveillance.

School bus stops are dangerous areas and should be approached with extreme caution. Near playgrounds, residential areas, and schools, be alert to children playing or running into the path of your bus from behind vehicles, structures, or vegetation. Watch for children playing in the snow or on the ice.

When driving in off-street areas, be alert to pedestrian traffic that may be entering or crossing the traffic aisle from any direction. When making left and especially right turns at intersections, check carefully for pedestrians crossing the street into the path of the bus.

## **Wildlife Hazards**

Regardless of time of day, you may encounter wildlife or domestic animals crossing into the path of the bus. Animal behaviour is unpredictable; be alert. Exercise extreme caution where highway signs indicate wildlife crossing areas. Whenever possible slow down, rather than hitting or swerving to avoid wildlife, as these actions may cause loss of vehicle control.

## **Vehicle Hazards**

In general, when sharing the road with other vehicles, observe the driving behaviour of other motorists. Scan all around the bus for clues to any of these potentially hazardous conditions:

- ◆ Loss of control. Recognize clues that may indicate another driver is losing control of the vehicle. Surface conditions may adversely influence oncoming vehicle control (e.g. slippery surfaces, ruts, deep snow). Note the other vehicle's movements such as turning too fast.

*Example: If an oncoming driver is turning too sharply after an off-road recovery, or approaching from the side too fast to stop or turn.*

- ◆ Movements of your bus or another vehicle may affect other drivers.

*Example: Stopping too quickly to allow a following vehicle to stop in time.*

- ◆ Lack of communication by other drivers. Look for clues or situations where the driver of another vehicle may execute a manoeuvre without signalling. A vehicle slowing down in the roadway may be about to turn. A parked car with a driver in the driver's seat, engine running (exhaust), or turned wheels may be about to pull out from the curb. When another driver does signal, ensure it is the proper signal. A turn signal may have been left on from a previous manoeuvre. Remember that you too can fail to communicate.
- ◆ Failure of the other driver to observe. There may be clues indicating that another driver has not seen the bus and therefore may not be prepared to yield the right-of-way:
  - ◆ Others not responding:
 

*Example: Approaching intersection from the side without slowing. Failing to Observe and respond to your signal. Mirrors, posts, or dirty windows may obscure the driver's view.*
  - ◆ The driver's view may be restricted:
 

*Example: A vehicle may be partially hidden by trees and detectable to you only by reflection or dust.*
  - ◆ Your bus may not readily be seen:
 

*Example: When the sun is in the other driver's eyes.*
- ◆ Inadequate adjustment by the other driver to a specific situation. The other driver may do something that could cause hazard to you. The other driver may not be adjusting to:
 

*Example:*

  - *An obstruction, such as a pothole or barrier.*
  - *A surface condition such as ice or snow.*
  - *Another driver turning onto a street blocked by pedestrians.*
  - *A narrow bridge, curve, land drop, etc.*
- ◆ Slow moving or stopping vehicles. Watch for indications that another vehicle is slowing or may stop suddenly. Examples of slow moving vehicles include farm vehicles, underpowered vehicles, and trucks on hills. Frequently stopping vehicles include buses, trucks carrying inflammables at railway crossings, and other delivery vehicles. Other clues that may indicate slowing or stopping include vehicles engaged in turning or exiting, entering the roadway, merging with other vehicles, or approaching controlled intersections or railway crossings.
- ◆ Multiple vehicle hazards. Recognize clues in a traffic pattern that may indicate potential conflict. Vehicles entering the roadway from side roads, driveways, ramps, or parking spots may cause another driver to change lanes, slow down suddenly, or stop. A vehicle slowing or stopping may prompt another driver to steer around it. One vehicle may limit another's visibility, allowing the other driver to enter a potential conflict.
 

*Example: An oncoming vehicle turns left.*

- ◆ Combination of vehicle and road hazards. You should be able to identify potential hazards arising from the interaction of vehicles and roadways. Any point in the roadway at which drivers are confronted with decisions represents a potential point of conflict.

*Example: A vehicle exiting from a highway may suddenly return to the highway, or drivers unfamiliar with their routes may be in the wrong lane and change lanes suddenly as two major routes split.*

Any point at which the roadway is compressed represents a potential source of conflict.

*Example: A vehicle approaching a point where four lanes become two may suddenly change lanes.*

- ◆ Talking or texting on a cell phone.

*Example: The vehicle you are following is not being driven properly. You've noticed several driving errors such as the vehicle not staying in its lane; the driver failing to use signal lights; the vehicle slowing down then speeding up suddenly; the vehicle failing to stop at a crosswalk; the vehicle's brake lights coming on erratically.*

The driver's attention is not focused on driving.



U

N

I

T

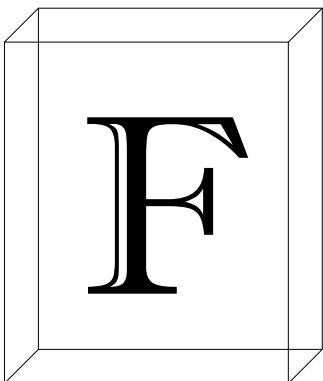

**ACCIDENT  
PREVENTION  
AND  
EMERGENCIES**

# ACCIDENT PREVENTION AND EMERGENCIES

Sound judgement will prevent many school bus accidents and emergencies from occurring. However, if you are involved in an accident or emergency, you may be called upon to administer first aid, extinguish fires, repair the bus, or take other necessary emergency action.

This unit is divided into two sections: the first details emergency driving techniques that can be used as a last measure to avoid an accident; the second covers accident and emergency procedures.

## EMERGENCY DRIVING TECHNIQUES

The single most effective action in an emergency is to ensure you remain in control. In order to achieve this it is necessary to buckle your seat belt every time while the bus is in operation. This action will ensure you are not thrown from the driver's seat. A defensive driver will be able to avoid potential emergency through good driving habits, a well-maintained vehicle, and proper observation. However, when confronted with any of the seven emergency driving situations listed below, knowledge of emergency driving techniques may prevent a possible disaster.

- ◆ Skidding
- ◆ Brake loss
- ◆ Sudden loss of visibility
- ◆ Obstruction in the path of the bus
- ◆ Pulsating brake pedal with anti-lock brakes (ABS)
- ◆ Tire blowout
- ◆ Contact with power lines

Response to these situations must become automatic due to the limited time available for evasive action. The procedures described are measures to prevent an accident.

### Skidding

Any number of factors can cause a school bus to go into a skid. During a skid, tires lose traction with the road surface. The normal means of controlling the bus (steering, braking, and accelerating) are affected. You must be able to detect a loss of traction in time to maintain or regain control of the bus. Loss of traction may include:

- ◆ Skids caused by tire failure resulting from under-inflation or sudden deflation from a blowout.
- ◆ Front wheel skids resulting from faulty brakes.
- ◆ Rear wheel skids resulting from faulty brakes, excessive acceleration or speed on curves, or rough or slippery surfaces. Remember that engine or exhaust brakes may cause a rear wheel skid if activated on slippery surfaces.



- ♦ All-wheel locked-brake skids resulting from severe application of brake pressure (or due to malfunction of the ABS brakes, if applicable).
- ♦ Hydroplaning which results from travelling too fast on a water-covered roadway. (Risk increases with poor tire condition or improper tire inflation.)

Before you can regain control of the vehicle, the cause of the skid must be corrected.

For example:

- ♦ if the skid is caused by over-braking, release the brake pedal so the wheels start to turn and the tires regain traction with the road surface.
- ♦ if the skid is caused by over-acceleration or over-steering, remove pressure from the accelerator smoothly (not suddenly) and do not accelerate again until steering control is re-established.

Regardless of how the skid occurs, the rear end of the vehicle may swing out to the left or right (fishtailing). Immediately apply controlled steering followed by controlled counter-steering to dampen fishtailing until steering control is re-established. Controlled steering means turning the wheels in the direction of the skid; in other words, turn the wheels so that you can head the way you were going before you started to skid. See the illustration on the following page.

(Read illustration from bottom to top.)

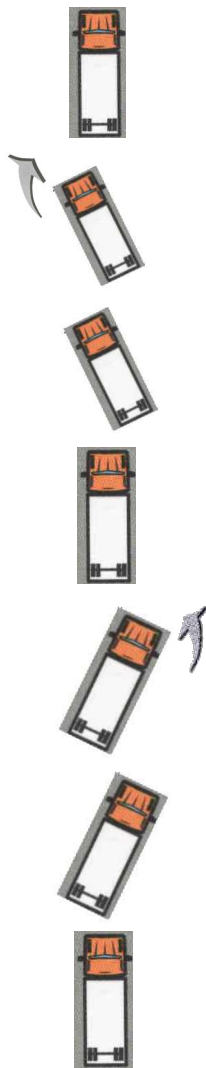

Steering control is re-established.

To control fishtailing in the opposite direction, you would countersteer right to help you get back on course.

The back end fishtails to the right.

The bus is back on course.

You would steer left, in the direction you want the bus to go relative to the way it's facing.

The back end of the bus skids to the left (the bus is still moving forward on an angle.)

The bus is going straight.

## **Brake Loss**

You are driving along the roadway, you step on the brake pedal to slow down or stop, and the pedal sinks slowly to the floor. What should you do?

1. Pump the brake pedal. If only partial failure has occurred, pumping the brake pedal may achieve partial braking force.
2. Select a clear path for leaving the stream of traffic and guide the bus to the shoulder of the road. On buses equipped with a manual park brake, gradually apply the park brake to bring the bus to a complete stop. It should be noted that on some newer model buses, the park brake may not be applied while the bus is in motion. Check with service personnel.
3. If you must leave the road to avoid a crash, select a path that will minimize injury and property damage. Look for something with a large surface area you can side swipe, such as a roadside bush, snow bank, guardrail, or parked cars. If you must go into a steep ditch, enter at an angle so that the bus does not overturn.

(Note: See Appendix F1 for procedures to follow if you experience brake loss while driving a school bus equipped with a manual transmission.)

## **Sudden Loss of Visibility**

Several things can cause a sudden loss of visibility - water splashing onto the windshield, headlight failure, the hood flies up, fog patches, etc.

- ◆ If the windshield becomes obscured (e.g. heavy rain or snow, windshield wiper failure), look out the left and right windows to maintain a sense of direction. Apply brakes moderately. Activate right turn signal and steer out of the traffic lane. When stopped, activate hazard-warning lamps.
- ◆ If the headlights fail, immediately press the dimmer switch and activate hazard-warning lamps. Take advantage of every source of light available to keep sight of the road. Brake slowly, steer out of the traffic lane, and stop.
- ◆ If a fog patch limits your visibility, activate low beams and hazard warning lamps, and slow down using centre or edge lines as a guide. In severe fog, steer the bus off the road and park as far off the road surface as possible. In foggy conditions, it is especially important to watch for other vehicles and ensure they can see your bus. Always ensure the strobe light on the roof of the bus is flashing in fog or inclement weather.

## **Obstruction in the Path of the Bus**

- ◆ Evasive action is required to avoid hitting an obstruction in the direct path of the bus or approaching it (e.g. a pedestrian, ball, other vehicle, construction barrier). Evasive action is simply the exercise of fundamental driving manoeuvres under conditions of stress (e.g. limited time, space, and distance). Evasive actions include:
  - ◆ Modulated braking.
  - ◆ Quick manoeuvring, with or without brakes.
  - ◆ Leaving the paved portion of the road, with or without roadside hazards present.
  - ◆ Accelerating if your bus may be hit from the side or behind.

- ◆ Braking – For effective evasive action, avoid the tendency to lock on the brakes. Generally, drivers tend to apply the brakes at the first sign of trouble. While effective in many instances, braking can lock the wheels and cause loss of steering control, making it impossible to steer away from a collision (except on ABS-equipped buses. See below.) On the other hand, braking to a stop may be the best evasive action to avoid the obstruction. This will depend on speed, how far away the object is, tire condition, and road surface conditions.
- ◆ Steering to Avoid Collision – When it is not possible to stop in time, the vehicle must be driven around the obstruction. Recognize the best "escape route" and decide whether a possible escape path is free from other, more hazardous obstacles. The size and weight of the bus limits ability to swerve sharply to avoid an object or to leave the roadway with any degree of control. Overturning is a danger. Steer firmly and as gradually as possible to clear the obstruction. Use only modulated braking if not ABS-equipped. If possible, avoid steering left into the opposite lane of traffic.
- ◆ Collision – Where collision is unavoidable, reduce speed as much as possible. Attempt to avoid a head-on collision by going to the right onto the shoulder or ditch if necessary. A collision at an angle lessens the force of impact.

### **Pulsating Brake Pedal with Anti-Lock Brake System (ABS)**

Upon brake pedal application, you may notice a pulsating pedal. This is an indication that the ABS brake system is activated and may occur when wheel lock-up is sensed by the system. To control braking, continue with constant brake pedal pressure. Modulated braking, or gentle application of the brakes, will slow the bus in a controlled manner.

School buses manufactured after September 1999 are equipped with ABS in accordance with Canadian Motor Vehicle Safety Standards.

An anti-lock brake system is an electronic system that monitors and controls wheel speed during braking. The system monitors wheel speed at all times. If it detects a wheel locking up during a brake application, the system limits brake pressure to that wheel only. This prevents the wheel from skidding and increases vehicle stability and control even in the most adverse situations such as braking on wet or icy roads, through curves, or during lane changes. When driving a vehicle with ABS, apply the brakes as normal to stop in time. When the ABS starts working, do not release the pressure you have applied to the brake pedal. Do not pump the brake pedal. The system automatically applies and releases the brakes up to forty times per second - much faster than you can pump the brake pedal.

It should be noted that ABS-equipped vehicles might have different stopping distances than those described in Stopping Distances on page 40. It should also be noted that if the ABS warning light comes on and the ABS feature fails to function, the standard foundation brakes would function normally. The ABS warning light should be reported to school bus service personnel immediately.

ABS safety check procedures are provided in the vehicle operator's manual.

## Tire Blowout

If you experience a tire, blow out, grip the steering wheel firmly, and steer your vehicle straight down the centre of your lane. Apply the brakes slowly to prevent lock-up. If the bus starts to skid, follow the skid control procedure outlined previously. Activate the right turn signal, slowly move right out of the lane of traffic, and stop. Activate the hazard warning lamps. If you are not in a safe location, evacuate students from the bus. Set out the triangular reflectors according to instruction.

## Contact with Power Lines

In the event that a school bus comes in contact with live power lines (e.g. from a downed hydro pole) assess the situation carefully. If there is no apparent danger (such as fire), it is safer for students to remain on the bus until help arrives.

If the school bus must be evacuated, remind students of the importance of NOT CONTACTING THE BUS AND THE GROUND AT THE SAME TIME as this could result in electrical shock. Instruct students to keep their hands tightly against their sides or folded across their chests. Open the service door if it is safe to do so and have student jump clear of the bus from the lowest step avoiding contact with the ground and the bus at the same time. Students should be instructed to hop away from the bus, then shuffle their feet until a safe distance away from the bus in order to avoid falling backward against the bus.

As with any evacuation procedure, have students assemble in a safe area at least 30 metres/100 feet from the school bus. See Manitoba Hydro's *School Bus Driver Electrical Safety* leaflet in Appendix F2.

## Mechanical Failure/Breakdown

The following steps should be taken in the event of mechanical failure/ breakdown:

- ◆ Stop the bus on the shoulder of the road or as far to the right of the road as possible.
- ◆ Keep students on the bus unless location of the bus is unsafe. In that case, move the students to a safe location (see *School Bus Evacuation Procedures* on page 72 of the *School Bus Driver's Handbook*).
- ◆ Place triangular reflectors on roadway (see *Using Emergency Equipment* on page 74 of the *School Bus Driver's Handbook* and the *MPI Professional Driver's Manual*).
- ◆ Contact appropriate school division authorities, giving location of the bus and description of the breakdown.
- ◆ Await further instruction.

## Prepare Your Bus for Winter Driving Conditions

Safe winter driving requires that you be prepared for road and weather conditions by carrying winter equipment and knowing what to do in an emergency.

- ◆ In diesel-powered school buses, follow the engine manufacturer's recommendations regarding fuel additives.
- ◆ Keep your fuel tank as full as possible when the temperature is below freezing.
- ◆ The windshield should be clean and the windshield wiper blades and arms in good condition.
- ◆ Keep the windshield washer fluid tank filled.
- ◆ Be sure the thermopane side windows are free from moisture or frost between the glass panes.

Carry a shovel (be sure to secure it properly), snow brush, ice scraper, and warm clothing.

## Blizzard Conditions

Blizzard conditions can develop at any time of day. Be prepared and familiar with the school division's emergency procedures.

- ◆ Should blizzard conditions make it unsafe to continue driving, pull as far as practical to the right side of the road. Leave headlights and marker lamps on, and activate the hazard warning lamps. Ensure the strobe light is flashing. Alert your dispatch office of your location and maintain constant communication by two-way radio or cell phone.
- ◆ Stay inside the bus and keep dry.
- ◆ Run the engine to warm the bus. Open windows slightly to maintain air circulation.
- ◆ If the engine stalls or must be shut off because of exhaust fumes entering the bus, close all windows and seal any drafts with available material to maintain heat.
- ◆ Keep the students awake and have them move around to keep warm.
- ◆ The first signs of carbon monoxide poisoning will be a sensation of tightness across the forehead, headache, nausea, and dizziness.
- ◆ The first signs of cold exhaustion will be shivering, cramps, and slowing of movement.

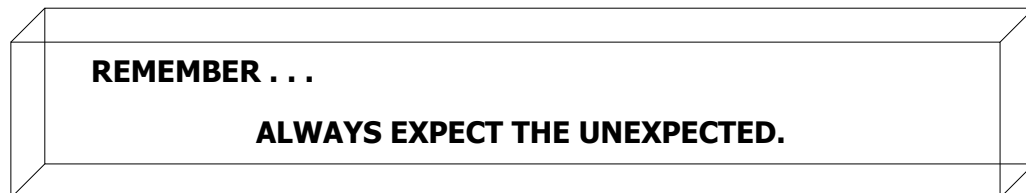

## ACCIDENT AND EMERGENCY PROCEDURES

### School Bus Evacuation Drills

*The Public Schools Act  
Manitoba Regulation 465/88R  
Pupil Instruction*

*17 The school board shall ensure that at least twice in each school year each pupil is instructed in safe school bus riding practices and participates in emergency school bus evacuation drills which shall be conducted at least once during the fall term and at least once during the spring term of each school year.*

- ◆ Students must be instructed in school bus passenger safety and procedures prior to participation in evacuation drills.
- ◆ Drills are to be held once in the fall and spring terms. All students must participate.
- ◆ Drills should be held in restricted off-street areas such as dedicated school bus loops, or parking lots where vehicle traffic is restricted.
- ◆ Emergency evacuation drills should include using both the front service door, the rear emergency exit door and split door evacuation.
- ◆ The orderly departure of students from the bus is paramount for safety.
- ◆ Chaperones, parents, teachers, and principals should participate in school bus evacuation drills to learn proper procedures.

### Reasons for Emergency Evacuation of Buses

- ◆ First, determine if an evacuation is necessary. Students are always safest on the bus.
- ◆ Fire or danger of fire - If any part of the school bus is on fire, stop the bus and evacuate immediately. Passengers should move to a point 30 metres/100 feet or more from the bus and remain there until the bus driver has determined that no danger exists. In the event a school bus is unable to drive away from an existing fire or combustible materials, danger of fire should be assumed and all passengers evacuated.
- ◆ Unsafe location - In the event a school bus is stopped in an unsafe location and is unable to proceed, the driver must immediately determine whether it is safer to evacuate passengers or have them remain on the bus.
- ◆ The driver **MUST** evacuate the school bus if the final stopping position:

- ♦ is in the path of any train; or, on or too close to any railway tracks.
- ♦ could change and increase danger (e.g. if the bus is near a body of water or precipice where it could continue to move and enter the water or tip over the precipice).
- ♦ is slippery and/or there is danger of collision (e.g. due to fog). Under normal traffic conditions, the bus should be visible from a distance of 150 metres/500 feet or more (e.g. a position over a hill or around a curve where such visibility does not exist).

### **General Guidelines to Follow in the Event of an Accident**

Presented below are general guidelines to follow in the event of an accident. The guidelines will be of value to you in any school bus accident situation; however, each accident will present a unique set of circumstances to which you will have to react.

- ♦ One of your best defences against the confusion at an accident scene is to remain as composed as possible. Remember that your passengers will most likely mirror your reaction to the situation.
- ♦ The safety of students is of utmost importance and must be given first consideration.
- ♦ Keep all students in the bus unless circumstances (e.g. possibility of fire; dangerous position of the bus) dictate their evacuation.
- ♦ Check for injured students, and if necessary, administer first aid.
- ♦ After an accident, set the park brake, place the transmission in park or neutral, and turn off the ignition.
- ♦ Keep a current list of contact names and phone numbers in the bus.
- ♦ Contact your school division dispatch office using the two-way radio. If the radio is inoperable, it is most likely that someone on the bus will carry a cell phone. Provide a clear description of the situation you are facing and indicate whether a police and/or medical presence is required. Under no circumstance should a driver leave the bus unattended to go for help. Follow school division policy.
- ♦ Protect the scene. By placing triangular reflectors around the bus or evacuating the bus, you will protect your passengers from further accident and/or injury. Protect the scene to ensure evidence is not destroyed. The vehicles involved in the accident should not be moved.
- ♦ While at the accident scene, do not release any of the students to anyone unless instructed to do so by school administrators, or medical aid is required.



## **School Bus Evacuation Procedures**

- ◆ The driver should stay in the bus to oversee evacuation procedures and be the last person out of the bus after ensuring that all students have exited the bus.
- ◆ Evacuations should be with "deliberate speed". A time interval of 2 to 2½ seconds per passenger has proven most efficient.
- ◆ To ensure a safe exit, passengers must have their hands free. All belongings must remain on the bus.
- ◆ Passengers selected and trained in advance can serve effectively as:
  - ◆ **Leaders** - Lead passengers to safety from each door utilized for evacuation to a safe point at least 30 metres/100 feet from the bus.
  - ◆ **Helpers** - Two students should be placed outside the rear emergency door to aid passengers as they exit the bus.

### **There are three primary types of emergency evacuation procedures:**

#### **Front service door evacuation**

Conduct using routine unloading procedures but with more urgency.

#### **Rear emergency exit door evacuation:**

- ◆ The bus driver will direct the pre-assigned leaders and helpers to take their positions, and instruct the passengers to perform the evacuation drill. Remind students to have their hands free, their coats buttoned (if applicable) and of the low rear doorway.
- ◆ Passengers are to remain seated until the bus driver directs them to exit. Depending on the nature of the emergency, the bus driver may choose to evacuate the bus starting at either the front or rear of the bus, and may evacuate one side at a time or on a staggered seat basis.
- ◆ The leader will open the rear emergency door, exit, and stand clear, ready to lead passengers to a safe location as pointed out by the driver.
- ◆ The helpers will take their positions, one on each side of the rear door, to assist passengers out of the bus in a safe, orderly manner. Helpers will present a hand, palm upwards, and avoid grasping exiting passengers.
- ◆ Each passenger should be two steps away from the rear of the bus before the next person exits.
- ◆ The school bus driver is the last person to exit the school bus after ensuring all passengers have evacuated. They will carry the first aid kit and join the students.

### **Split door evacuation utilizing both the front service door and the rear emergency exit door:**

- ♦ The purpose of the split door evacuation is to evacuate students as quickly as possible due to immediate danger to students. For example, the school bus stalls on the railway crossing.
- ♦ The driver positions themselves at the mid-point of the bus and directs students in the front half of the bus to exit by the front service door, and students in the rear half of the bus to exit by the rear emergency door.

Regardless of the type of emergency evacuation used, the school bus driver is the last person to exit the school bus after ensuring all passengers have evacuated. The driver will carry the first aid kit and join the students. **For more details to evacuation, procedures see appendix F4.**

For extensive information on driving emergencies and collisions, it is recommended that you consult the Driver's Handbook published by Manitoba Public Insurance.

### **School Bus Captains**

- ♦ The school bus driver is responsible for student safety; however, in an emergency, a driver may be unable to direct the evacuation. Therefore, school bus captains should be selected, trained, and prepared for evacuation.
- ♦ School bus captains should:
  - ♦ be mature.
  - ♦ demonstrate leadership qualities.
  - ♦ be on the bus for the entire route.
  - ♦ have written parental permission.
- ♦ The training program will prepare the captain to:
  - ♦ turn off the ignition switch.
  - ♦ set the park brake.
  - ♦ summon help (instructions and telephone numbers should be available on the bus).
  - ♦ use emergency windows and/or roof hatches.
  - ♦ place triangular reflectors.
  - ♦ open and close the service and emergency exit doors.
  - ♦ direct school bus evacuations.
  - ♦ account for all passengers.

## Using Emergency Equipment

It is important to familiarize yourself with the use of emergency equipment before an emergency or accident occurs. You must know the location and operation of the:

- ◆ Triangular reflectors
- ◆ Fire axe or crow bar
- ◆ Fire extinguisher
- ◆ First aid kit
  
- ◆ **Triangular reflectors:** which serve as warning devices, are stored in a container located in the driver's compartment or close to the rear emergency door. On a non-divided roadway/highway, place the first triangle 3 metres in front of the bus. Place the second triangle 30 metres to the front of the bus. The third triangle is to be placed 30 metres from the rear of the bus. On a divided roadway/highway place triangles at the following distances from the rear of the bus. First position 3 metres, second position 30 metres and third position at 60 metres. The reflective side of the triangles are to be placed towards oncoming traffic to warn them of the hazard. (See MPI Professional Driver's Manual for more details)
  
- ◆ **The fire axe or crow bar** is located close to the driver's compartment. Use it to pry or break open doors, windows, etc. when circumstances prevent easy exit by normal methods.
  
- ◆ **A portable fire extinguisher** is located in the driver's compartment of every school bus. Fire extinguishers work by either cooling a burning substance or by cutting off its oxygen supply. School buses are currently equipped with 3A:40B: C dry chemical fire extinguishers, which are filled with a fine, dry powder. A gauge is mounted on the top of the fire extinguisher indicating the charge pressure, and is usually divided into two areas of green and red indicating low and high pressure. If the gauge needle is in the green area, the fire extinguisher is properly charged. Qualified service personnel must inspect the fire extinguisher annually. To operate the fire extinguisher, remove it from the bracket, and pull the safety pin, which will break the seal. Hold the fire extinguisher in an upright position and squeeze the handle to discharge the powder. Squeeze the handle on and off as required to control the fire.

If possible, stand upwind from burning material to prevent standing in smoke and heat. Do not walk into unburned material that could catch fire in a back draft and cause injury. Do not fully raise the hood when an under-hood fire occurs. This will allow oxygen to get to the fire. Raise the hood very slightly, or if the hood cannot be opened, direct the fire extinguisher from underneath the vehicle or through the radiator. Conserve some chemical in the extinguisher in case of flare-up. The fire extinguisher, regardless of the extent of use, must be recharged or replaced before the next run.

- ◆ **First Aid Kit:** School buses must carry a unitized first aid kit packed in a sturdy, dustproof, removable container. As per CSA D250, the kit shall contain at least the following items. Always check the label inside the box to verify the required content as requirements do change from time to time.
  - (a) one first aid pocket guide
  - (b) one record book
  - (c) two resuscitation face barriers with a one-way valve
  - (d) four pairs of non-latex gloves
  - (e) four emergency blankets
  - (f) 150 individually wrapped 25 x 75 mm (1 x 3 in) adhesive dressings
  - (g) eight 50 mm (2 in) compress dressings
  - (h) six 100 mm (4 in) compress dressings
  - (i) two gauze eye pads
  - (j) one eye shield
  - (k) three 4-ply gauze dressings, a minimum of 914 x 914 mm (36 x 36 in) in size
  - (l) two 50 mm x 5.5 m (2 in x 6 yd) gauze bandages
  - (m) one packet of 25 mm x 4.6 m (1 in x 15 ft) adhesive tape
  - (n) six triangular bandages
  - (o) one 70 x 610 mm (2¾ x 24 in) rolled metal splint
  - (p) splint paddings
  - (q) one pair of sliver tweezers
  - (r) one pair of 15 cm (6 in) scissors
  - (s) twelve 50 mm (2 in) safety pins

The first aid kit shall be mounted in a location readily accessible to the driver. If the first aid kit is not in view (e.g. in an enclosed compartment), its location shall be clearly marked.

## Incident Reporting

Because of possible liability issues, it is a driver's responsibility to report to your supervisor all incidents and out-of-the-ordinary circumstances occurring during the course of a daily route (e.g. bumped heads with no apparent injury; a collision between two vehicles even though the bus was not involved; abnormal road conditions).

All school bus accidents, regardless of severity, are to be reported to the Pupil Transportation Unit, Manitoba Education. A School Bus Accident Report Form can be found in Appendix F3. The report form can also be accessed through the Pupil Transportation Unit website at: [www.edu.gov.mb.ca/k12/ptu](http://www.edu.gov.mb.ca/k12/ptu)



# CONCLUSION

# CONCLUSION

---

The school bus driver's future is bright. Driver in-servicing and upgrading continues to be an important aspect of school bus transportation. The school bus vehicle, arguably the safest vehicle on the road today, undergoes constant improvement. The focus placed on "getting kids to and from school safely" never waivers.

You are now part of a team of more than 3,000 school bus drivers in Manitoba who transport more than 68,000 students every day. The fleet of approximately 2,300 school buses travels more than 33,000,000 kilometres on Manitoba roads every year. Each school bus driver has undergone the same processes and learned the same skills you have just acquired. School bus accidents are few, and rarely serious. This team has learned its lessons well.

Congratulations on your achievement. You are now part of a very important team, and on your way to a fulfilling and enjoyable career.

# APPENDICES

## Unit A

A1 School Bus Regulation 465-88R

## Unit B

B1 School Bus Seating Plan Samples

B2 Safety Rules For Students Riding the School Bus

B3 School Bus Misconduct Report

B4 The Public Schools Act – Code of Conduct Regulations

- Section 47.1(2)
- Section 47.1(2.1)
- Section 58.10

## Unit C

C1 School Bus Pre-Trip Inspection Checklist

C2 Canadian Motor Vehicle Safety Standards – CMVSS 111  
Mirror Testing Protocol

C3 Engine Starting and Warm-Up Procedures for Diesel  
Engines

C4 Manual Transmissions –  
Preventive Maintenance Checks

C5 Sample School Bus Idling Policy

## Unit D

D1 Manual Transmissions – Driving Fundamentals

D2 Sample “Don’t Pass Law” Violation Report

D3 *The Highway Traffic Act* – Railway Crossings

D4 Loading and Unloading at Turnarounds

## Unit F

F1 Manual Transmissions – Brake Loss

F2 School Bus Driver Electrical Safety

F3 Pupil Transportation Unit’s School Bus Accident Report  
Form

F4 School Bus Evacuation Procedures





As of 14 Sep 2022, this is the most current version available. It is current for the period set out in the footer below.

Last amendment included: M.R. 83/2020

Le texte figurant ci-dessous constitue la codification la plus récente en date du 14 sept. 2022. Son contenu était à jour pendant la période indiquée en bas de page.

Dernière modification intégrée : R.M. 83/2020

---

THE PUBLIC SCHOOLS ACT  
(C.C.S.M. c. P250)

---

**School Buses Regulation**

---

Regulation 465/88 R  
Registered November 7, 1988

TABLE OF CONTENTS

Section

1	"School bus" defined
2	Repealed
3	Alteration or modification prohibited
4	Standards and specifications
4.1	Exclusion for 2020-2021 school year
5	Inspection of operation
6	Inspection certificate
7-8	Repealed
9	Examination of operator
10	Use of school bus for other purposes
11-12	Authorized uses
13	Passenger behaviour
14	Loading and unloading
15	Requirements of driver
16	Prohibitions
17	Pupil instruction
18	Driver instruction
19	Log book

---

LOI SUR LES ÉCOLES PUBLIQUES  
(c. P250 de la C.P.L.M.)

---

**Règlement sur les autobus scolaires**

---

Règlement 465/88 R  
Date d'enregistrement : le 7 novembre 1988

TABLE DES MATIÈRES

Article

1	Définition
2	Abrogé
3	Transformation ou modification interdite
4	Normes et spécifications
4.1	Exclusion pour l'année scolaire 2020-2021
5	Inspection des autobus scolaires
6	Certificat d'inspection
7-8	Abrogés
9	Examens
10	Utilisation à d'autres fins
11-12	Utilisations autorisées
13	Comportement des passagers
14	Embarquement et débarquement des passagers
15	Exigences que doivent remplir les conducteurs
16	Interdictions
17	Enseignement des mesures de sécurité
18	Formation des conducteurs
19	Journal de bord

**"School bus" defined**

**1** In this regulation, "**school bus**" means a vehicle that is designed and classified by the manufacturer as a school bus and used to transport pupils and other authorized persons to or from school or to or from approved school related activities.

M.R. 139/95

**2** [Repealed]

M.R. 139/95

**Alteration or modification prohibited**

**3** Unless authorized under *The Highway Traffic Act* or a regulation made thereunder, no person shall alter or modify or cause to be altered or modified any school bus vehicle or equipment thereof unless that specific alteration or modification has been approved by the minister or by an official designated by the minister.

**Standards and specifications**

**4** Each school bus registered under *The Highway Traffic Act* in the name of a school board, and each school bus that is under contract with a school board, shall conform to standards and specifications as follows:

(a) Canadian Standards Association--Standards for School Buses, as amended from time to time, are hereby adopted and constituted as part of this regulation;

(b) each school bus shall comply with the Canadian Standards Association School Bus Standards in effect for the model year of the school bus and, in addition, shall be equipped with

(i) a stop arm installed on the left side of the bus, and the stop arm and installation shall meet or exceed the requirements of SAE Standard J1133a Stop Arm,

**Définition**

**1** Pour l'application du présent règlement, « **autobus scolaire** » s'entend d'un véhicule que le fabricant conçoit et classe à titre d'autobus scolaire et qui est utilisé pour le transport d'élèves et d'autres personnes autorisées à partir de l'école ou jusqu'à celle-ci ou à partir du lieu d'une activité scolaire autorisée ou jusqu'à celui-ci.

R.M. 139/95

**2** [Abrogé]

R.M. 139/95

**Transformation ou modification interdite**

**3** Nul ne peut, à moins d'y être autorisé en vertu du *Code de la route* ou d'un règlement pris sous son régime, transformer ou modifier, ou faire transformer ou modifier un autobus scolaire ou son équipement, sauf si la transformation ou la modification en cause a été approuvée par le ministre ou par un fonctionnaire désigné par le ministre.

**Normes et spécifications**

**4** Les autobus scolaires immatriculés au nom d'une commission scolaire en application du *Code de la route* ainsi que les autobus scolaires faisant l'objet d'un contrat avec une commission scolaire doivent satisfaire aux normes et aux spécifications techniques suivantes :

a) la norme Autobus scolaires de l'Association canadienne de normalisation ainsi que ses modifications, sont par les présentes adoptées et intégrées au présent règlement;

b) les autobus scolaires sont conformes à la norme Autobus scolaires de l'Association canadienne de normalisation en vigueur à l'égard de l'année de modèle de l'autobus scolaire et sont équipés :

(i) d'un signal d'arrêt escamotable fixé sur le côté gauche de l'autobus, le signal escamotable et son mode de fixation devant être conformes aux exigences de la norme SAE J1133a intitulée « Stop Arm » ou les excéder,

- (ii) two alternately flashing red lamps and two alternately flashing yellow lamps on the front and on the rear, and the lamps shall be controlled by a manually activated switch and shall meet or exceed the specific and general requirements of SAE Standard J887 May 82 School Bus Warning Lamps,
- (iii) a pedestrian-student safety crossing arm, located at the right front corner of the chassis, that conforms with the CSA standards for such crossing arms, and
- (iv) a sign indicating "This School Bus (Vehicle) Stops At All Railway Crossings" that is installed at an approved location on the rear of the school bus;
- (c) [repealed] M.R. 139/95;
- (d) [repealed] M.R. 101/99;
- (e) no school bus shall have exposed sharp edges that may cause injury to passengers;
- (f) no school bus built in model year 2001 or afterwards shall contain, or have affixed to any part of it, glass that does not meet existing Canadian Motor Vehicle Safety Standards for laminated vehicle glass;
- (f.1) no school bus shall be equipped with overhead luggage racks;
- (g) no school bus shall be equipped with retread tires on the front axle;
- (h) no school bus shall be equipped with jump seats or portable seats;
- (i) each school bus, and all school bus equipment, shall be maintained in accordance with original equipment manufacturer's recommended procedures as set out in published repair and maintenance manuals and shall be kept clean and sanitary at all times, and is at all times subject to inspection as hereinafter provided;
- (ii) de deux feux d'avertissement rouges à clignotement alterné et de deux feux d'avertissement jaunes du même genre à l'avant et à l'arrière du véhicule qui sont mis en circuit et hors circuit par un commutateur à commande manuelle et qui sont conformes aux exigences précises et générales de la norme SAE J887 (mai 1982) intitulée « School Bus Warning Lamps » ou les excèdent,
- (iii) d'un bras de sécurité pour autobus scolaire fixé sur le coin avant droit du châssis de l'autobus et respectant les normes applicables de l'Association canadienne de normalisation,
- (iv) d'un panneau portant la mention « This School Bus (Vehicle) Stops At All Railway Crossings » et fixé, à l'arrière, à un endroit approuvé;
- c) [abrogé] R.M. 139/95;
- d) [abrogé] R.M. 101/99;
- e) les autobus scolaires ne doivent comporter aucun rebord tranchant exposé susceptible de causer des blessures aux passagers;
- f) il est interdit d'installer sur un autobus scolaire d'un modèle 2001 ou subséquent, ou de fixer à une partie de celui-ci, un élément de verre non conforme aux Normes de sécurité des véhicules automobiles du Canada en vigueur applicables au verre feuilleté utilisé dans les véhicules;
- f.1) il est interdit d'installer des compartiments de rangement supérieurs dans un autobus scolaire;
- g) il est interdit d'installer des pneus rechapés sur l'essieu avant d'un autobus scolaire;
- h) il est interdit de munir un autobus scolaire de strapontins ou de sièges portatifs;
- i) les autobus scolaires et leur équipement doivent être entretenus conformément aux méthodes recommandées par le fabricant d'équipement d'origine dans les guides de réparation et d'entretien, ils doivent être maintenus en tout temps en bon état de propreté et de salubrité et ils peuvent être inspectés à tout moment, de la manière prévue ci-après;

(j) each school bus used to transport pupils in wheelchairs shall be equipped with a securely fastened wheelchair retaining device for each wheelchair, and

(i) in the case of a school bus manufactured before 1985, the retaining device shall be equivalent to the Collins pin lock system, and

(ii) in the case of a school bus manufactured in 1985 or any subsequent year, the retaining device shall be equivalent to the requirements of CSA Standard D409-M84 (forward facing wheelchairs, 4 point tie-down system);

(k) no school bus, while transporting pupils, shall be used to carry any animal, firearm, explosive, flammable liquid, or anything of a dangerous or objectionable nature, or any article likely to endanger the safety of the passengers.

M.R. 256/90; 88/92; 21/94; 139/95; 101/99; 109/2000; 175/2006

#### **Exclusion for 2020-2021 school year**

**4.1** Clause 4(f) does not apply during the 2020-2021 school year.

M.R. 83/2020

#### **Inspection of operation**

**5** A person designated by a school board may, at any time, inspect any school bus being operated under the authority of that school board, and any person designated by the minister, or any police officer, may inspect any school bus at any time, and if upon inspection that person considers

(a) that the school bus is not in accordance with *The Highway Traffic Act* and this regulation;

(b) that the school bus is being operated in a manner which is not in accordance with *The Highway Traffic Act* and this regulation, or which is careless or negligent; or

(c) that the driver is unfit or incapable of operating the school bus;

that inspector may require the driver to stop and discontinue the operation of the school bus for such period, and subject to such conditions as to further operation, as that inspector may impose.

j) les autobus scolaires utilisés pour le transport des élèves en fauteuil roulant doivent être munis, pour chaque fauteuil, d'un dispositif d'immobilisation de fauteuil roulant bien arrimé :

(i) qui, pour les autobus scolaires manufacturés avant 1985, est l'équivalent du système Collins d'immobilisation à verrouillage de la roue,

(ii) qui, pour les autobus scolaires manufacturés à partir de 1985, est conforme aux exigences de la norme CSA D409-M84 (ceinture de sécurité à quatre points d'appui pour les fauteuils roulants placés de front dans le véhicule);

k) pendant le transport d'élèves, les autobus ne peuvent servir au transport d'animaux, d'armes à feu, d'explosifs, de liquides inflammables ou de quelque chose de dangereux ou d'inacceptable, ou de quelque article susceptible de mettre en danger la sécurité des passagers.

R.M. 256/90; 88/92; 21/94; 139/95; 101/99; 109/2000; 175/2006

#### **Exclusion pour l'année scolaire 2020-2021**

**4.1** L'alinéa 4f) ne s'applique pas pendant l'année scolaire 2020-2021.

R.M. 83/2020

#### **Inspection des autobus scolaires**

**5** Les personnes désignées par une commission scolaire peuvent, en tout temps, inspecter les autobus scolaires utilisés sous l'autorité de cette commission scolaire et les personnes désignées par le ministre, ainsi que les agents de police, peuvent, en tout temps, inspecter les autobus scolaires. Ces personnes peuvent ordonner au conducteur d'arrêter l'autobus scolaire et de cesser de le conduire pendant la période qu'elles déterminent, et elles peuvent assujettir à certaines conditions toute utilisation ultérieure, si, après leur inspection, elles estiment, selon le cas :

a) que l'autobus scolaire n'est pas conforme au *Code de la route* et au présent règlement;

b) que l'autobus scolaire est conduit d'une manière non conforme au *Code de la route* et au présent règlement, ou de manière imprudente ou négligente;

c) que le conducteur est inapte à conduire l'autobus ou incapable de le faire.

**Inspection certificate**

**6(1)** A person who is under contract with a school board and who is registered as owner of a school bus under *The Highway Traffic Act* shall,

(a) immediately on receipt, file with the school board a copy of the subsisting inspection certificate for the school bus that is required by the *Periodic Mandatory Vehicle Inspection Regulation*, Manitoba Regulation 76/94; and

(b) keep a copy of the inspection certificate in the driver's compartment of the school bus.

**6(2)** An inspection certificate referred to in subsection (1) must be signed by a qualified repair mechanic who holds a certificate under *The Apprenticeship and Trades Qualification Act* or by a qualified repair mechanic approved by the school board.

**6(3)** No mechanic shall issue an inspection certificate referred to in subsection (1) for a school bus unless

(a) the mechanic has inspected the bus; and

(b) the brakes, steering mechanism, wheel alignment, lights and other mechanisms and equipment of the bus are in a safe and proper condition and comply with *The Highway Traffic Act*.

M.R. 139/95

**7 and 8** [Repealed]

M.R. 139/95

**Examination of operator**

**9** A school board, or the minister, or a person designated by the minister, may require any person who operates a school bus to pass an examination as provided under subsection 31(6) of *The Highway Traffic Act*, and may require that the person pass other examinations within such period as the minister may prescribe.

**Certificat d'inspection**

**6(1)** Les personnes liées par contrat à une commission scolaire et inscrites à titre de propriétaires d'un autobus scolaire en application du *Code de la route* :

a) dès qu'elles reçoivent le certificat d'inspection valide pour l'autobus en question exigé en application du *Règlement sur l'inspection périodique et obligatoire des véhicules, règlement du Manitoba 76/94*, en déposent une copie auprès de la commission scolaire;

b) gardent une copie du certificat d'inspection dans la cabine du conducteur de l'autobus scolaire.

**6(2)** Les certificats d'inspection visés au paragraphe (1) doivent être signés par un mécanicien en réparation qualifié qui est titulaire d'un certificat délivré en application de la *Loi sur l'apprentissage et la qualification professionnelle* ou qui est approuvé par la commission scolaire.

**6(3)** Il est interdit aux mécaniciens de délivrer le certificat d'inspection visé au paragraphe (1) pour un autobus scolaire, à moins :

a) qu'ils aient inspecté l'autobus;

b) que les mécanismes et l'équipement, notamment les freins, la direction, le parallélisme des roues et les phares soient en bon état et soient conformes aux exigences du *Code de la route*.

R.M. 139/95

**7 et 8** [Abrogés]

R.M. 139/95

**Examens**

**9** Les commissions scolaires, le ministre ou une personne désignée par le ministre peuvent exiger des personnes qui conduisent un autobus scolaire qu'elles subissent avec succès l'examen prévu au paragraphe 31(6) du *Code de la route* et qu'elles réussissent d'autres examens au cours de la période prescrite par le ministre.

**Use of school bus for other purposes**

**10** A vehicle that is registered as a school bus and for other purposes under *The Highway Traffic Act*, shall not be used for those other purposes during any period in which the vehicle is used as a school bus, and unless all marks showing or indicating that it is a school bus are concealed, no person shall operate a school bus for purposes other than those set out in section 11.

**Authorized uses**

**11** Notwithstanding section 10, a school board may authorize the use of a school bus

- (a) to transport pupils for the purpose of participating in or attending extracurricular activities;
- (b) to transport trustees, administrative officers and teachers employed by the school division or district while carrying out their regular duties or attending professional development sessions; and
- (c) as may be required for the purpose of repairing or servicing it.

---

M.R. 175/2006

**12** A school bus shall not be used for any of the purposes stated in clauses 11(a) and (b) unless

- (a) the use has been approved by the school board or a person designated by the school board;
- (b) there is at all times, in full force and effect, insurance coverage in an amount satisfactory to the minister providing for the payment of damages for the injury to, or the death of, one or more persons, including any passengers, and those persons referred to in section 11, and for the payment of damages arising from loss or damage to property;
- (c) it is driven by a qualified driver in accordance with *The Highway Traffic Act* and this regulation; and
- (d) where pupils are to be transported, they are accompanied in the school bus by a person designated by the school board.

**Utilisation à d'autres fins**

**10** Les véhicules immatriculés en application du *Code de la route* à titre d'autobus scolaire et à d'autres fins ne peuvent être utilisés à ces autres fins pendant la période au cours de laquelle ils sont utilisés à titre d'autobus scolaire. Nul ne peut exploiter un autobus scolaire à des fins autres que celles mentionnées à l'article 11 à moins de dissimuler les inscriptions montrant ou indiquant qu'il s'agit d'un autobus scolaire.

**Utilisations autorisées**

**11** Par dérogation à l'article 10, une commission scolaire peut autoriser l'utilisation d'un autobus scolaire aux fins suivantes :

- a) le transport d'élèves qui vont participer ou assister à des activités hors programme;
- b) le transport des commissaires, des agents d'administration et des enseignants qui sont employés par la division ou le district scolaire et qui exercent leurs fonctions habituelles ou qui assistent à des séances de perfectionnement professionnel;
- c) le déplacement de l'autobus scolaire à des fins de réparations ou d'entretien.

---

R.M. 175/2006

**12** Il est interdit d'utiliser un autobus scolaire aux fins énoncées aux alinéas 11a) et b) sauf dans les cas suivants :

- a) l'utilisation a été approuvée par la commission scolaire ou par une personne désignée par celle-ci;
- b) une police d'assurance dont le montant de couverture est jugé satisfaisant par le ministre est en vigueur, à tout moment, garantissant le paiement des dommages-intérêts découlant de blessures subies par une ou plusieurs personnes ou de leur décès, y compris les passagers et les personnes mentionnées à l'article 11, ainsi que le paiement des dommages-intérêts découlant de la perte de biens ou de dommages causés à ceux-ci;
- c) l'autobus est conduit par un conducteur compétent, conformément au *Code de la route* et au présent règlement;
- d) pendant le transport d'élèves, ceux-ci sont accompagnés d'une personne désignée par la commission scolaire.

**Passenger behaviour**

**13(1)** The principal of a school whose pupils are being transported in the school bus has the same disciplinary authority over the conduct of the pupils during the period in which they are in, entering upon, or alighting from the school bus, as is provided by the regulations under *The Education Administration Act*.

**13(2)** Where a pupil in a school bus persists in conduct likely to be detrimental or hazardous to the welfare of the passengers, the principal has the same authority as is provided by the regulations under *The Education Administration Act*.

**13(3)** The driver of a school bus shall report to the principal any misconduct of pupils while entering, leaving, or being conveyed in a school bus under that driver's charge.

**13(4)** Except with the permission, and under the supervision, of the principal of the school or another person assigned by the principal for the purpose, no driver of a school bus shall back the school bus on school grounds.

**Loading and unloading**

**14(1)** Subject to the approval of the school board, the principal of the school shall

- (a) prepare a plan for loading and unloading the school bus;
- (b) designate a loading and unloading zone on or adjacent to the school grounds; and
- (c) supervise or assign a responsible person to supervise the loading and unloading of the school bus.

**14(2)** When pupils are entering or leaving a school bus, the driver of the school bus shall park the school bus in such a position that the side of the bus on which the exit doors are located is closest to the school.

**Comportement des passagers**

**13(1)** Le directeur d'une école dont les élèves sont transportés dans un autobus scolaire dispose à l'égard du comportement des élèves pendant les périodes où ils se trouvent dans l'autobus scolaire, ou qu'ils y montent ou en descendent, du même pouvoir disciplinaire que celui prévu aux règlements d'application de la *Loi sur l'administration scolaire*.

**13(2)** Dans les cas où un élève qui se trouve dans un autobus scolaire persiste à se comporter d'une manière susceptible d'être préjudiciable ou dangereuse pour l'intérêt des passagers, le directeur dispose du même pouvoir que celui prévu aux règlements d'application de la *Loi sur l'administration scolaire*.

**13(3)** Les conducteurs d'un autobus scolaire signalent au directeur tout écart de conduite des élèves lorsqu'ils montent dans un autobus scolaire dont ils ont la charge ou en descendent, ou encore pendant le trajet.

**13(4)** Il est interdit aux conducteurs d'autobus scolaire de faire marche arrière avec un autobus scolaire sur les terrains d'une école sauf avec l'autorisation et sous la supervision du directeur de l'école ou d'une autre personne désignée à cette fin par ce dernier.

**Embarquement et débarquement des passagers**

**14(1)** Sous réserve de l'approbation de la commission scolaire, le directeur d'école :

- a) élabore un plan d'embarquement et de débarquement des passagers des autobus scolaires;
- b) désigne une zone d'embarquement et de débarquement des passagers sur les terrains de l'école ou à un endroit adjacent à ceux-ci;
- c) supervise l'embarquement et le débarquement des passagers des autobus scolaires ou désigne un responsable à cette fin.

**14(2)** Lorsque des élèves montent dans un autobus scolaire ou en descendent, le conducteur stationne l'autobus de façon à ce que le côté de celui-ci où sont situées les portes de sortie soit le plus près de l'école.

**14(3)** Except as provided in subsection (4), no driver of a school bus shall stop the school bus, for the purpose of picking up or discharging pupils, in such a position as to require pupils to cross a highway in order to enter, or to reach a place of safety after leaving, a school bus.

**14(4)** Notwithstanding subsection (3), where it is not practicable for pupils to enter a school bus, or to reach the school grounds or a place of safety after leaving a school bus, without crossing a highway, the driver shall

(a) stop the bus and keep it stopped; and

(b) continually display flashing signal lights as provided in *The Highway Traffic Act*;

until the pupils have entered the school bus or have reached the school grounds or a place of safety after leaving the school bus; and

(c) supervise the crossing of the highway by the pupils.

**14(5)** Except in the case of emergency, the driver shall use only the front door of the school bus for the purpose of picking up and discharging pupils.

**14(6)** Where a school bus is stopped and pupils are getting on to the bus, or are about to get on to the bus, or are getting off the bus, or are about to get off the bus, the driver

(a) shall put into operation all of the lamps with which the school bus is equipped in accordance with *The Highway Traffic Act*; and

(b) shall cause to be put into operation such other warning devices authorized in *The Highway Traffic Act*.

M.R. 109/2000

#### Requirements of driver

**15** The driver of a school bus shall

(a) have a valid driver's licence to operate a school bus vehicle;

(b) be competent to operate the vehicle under his or her charge;

**14(3)** Sous réserve des dispositions du paragraphe (4), les conducteurs d'autobus scolaire qui s'apprêtent à laisser monter ou descendre des élèves ne peuvent immobiliser leur autobus à un endroit tel que les élèves aient à traverser une route afin de pouvoir y monter ou atteindre un lieu sûr après en être descendu.

**14(4)** Par dérogation au paragraphe (3), dans les cas où des élèves doivent traverser une route afin de pouvoir monter dans un autobus scolaire ou atteindre les terrains de l'école ou un lieu sûr après être descendus de l'autobus, le conducteur :

a) immobilise l'autobus;

b) fait fonctionner les feux clignotants de façon continue conformément aux dispositions du *Code de la route*;

jusqu'à ce que les élèves soient montés dans l'autobus ou aient atteint les terrains de l'école ou un lieu sûr après être descendus de l'autobus;

c) surveille les élèves qui traversent la route.

**14(5)** Sauf en cas d'urgence, les conducteurs ne peuvent utiliser que la porte avant de l'autobus scolaire pour faire monter et descendre les élèves.

**14(6)** Lorsqu'un autobus scolaire est arrêté et que des élèves y montent ou en descendent, ou s'apprêtent à le faire, le conducteur :

a) allume tous les feux dont l'autobus scolaire est muni, conformément au *Code de la route*;

b) actionne tout autre dispositif d'avertissement autorisé par le *Code de la route*.

R.M. 109/2000

#### Exigences que doivent remplir les conducteurs

**15** Les conducteurs d'autobus scolaire doivent satisfaire aux exigences suivantes :

a) être titulaire d'un permis de conduire valide les autorisant à conduire un autobus scolaire;

b) posséder la compétence nécessaire pour conduire le véhicule dont ils ont la responsabilité;



(c) determine the safe condition of the school bus by daily inspection and immediately report any defect to the school board;

(d) comply with all the requirements in *The Highway Traffic Act* and these regulations;

(e) make such reports, and complete such records and forms as are required by the school board;

(f) operate the school bus over such routes, and on the days and times as required by the school board;

(g) immediately report any accident arising out of the operation of the school bus, as required by *The Highway Traffic Act*, and to the school board;

(h) not operate the school bus after an accident arising out of the operation of the school bus, until he or she has instructions from the school board to do so, and the school bus is in a safe mechanical condition;

(i) obtain a school bus operator's certificate from the office of the Pupil Transportation Unit of the Department of Education and Training before operating a school bus carrying passengers; and

(j) whether carrying passengers or not, before crossing any track or tracks of a railway, bring the school bus to a full stop not less than 5 metres or more than 15 metres from the rail nearest the front of the school bus, and fully open the service door, listen and look in both directions along the track or tracks for approaching trains not proceed unless the action can be completed in safety, and close the service door when motion is resumed.

M.R. 139/95; 101/99

### Prohibitions

**16** No driver of a school bus shall

(a) operate a school bus contrary to *The Highway Traffic Act* and this regulation;

(b) leave a school bus unattended while pupils are in the bus, except when required to assist other pupils to cross the highway;

c) inspecter chaque jour l'autobus scolaire afin de s'assurer qu'il peut rouler en toute sécurité et signaler sans délai toute défectuosité à la commission scolaire;

d) se conformer aux exigences du *Code de la route* et des présents règlements;

e) préparer les rapports et remplir les registres et les formules exigés par la commission scolaire;

f) emprunter le parcours et suivre l'horaire établis par la commission scolaire;

g) signaler sans délai tout accident découlant de l'utilisation de l'autobus scolaire de la manière prévue au *Code de la route*, ainsi qu'à la commission scolaire;

h) attendre, avant de conduire un autobus scolaire qui vient d'être impliqué dans un accident pendant son utilisation, d'avoir reçu les directives en ce sens de la commission scolaire, et que l'autobus soit en bon état de marche;

i) obtenir un brevet de chauffeur d'autobus scolaire de la Section de transport des élèves du ministère de l'Éducation et de la Formation professionnelle avant de conduire un autobus scolaire transportant des passagers;

j) avant de traverser les voies ferrées d'un chemin de fer, arrêter complètement leur autobus, qu'il y ait des passagers ou non, à au moins cinq et au plus quinze mètres de la voie ferrée la plus près de l'avant du véhicule, ouvrir complètement la porte avant, écouter et regarder dans les deux directions des voies ferrées, ne pas repartir à moins de pouvoir traverser en toute sécurité et ne refermer la porte qu'après la remise en marche du véhicule.

R.M. 139/95; 101/99

### Interdictions

**16** Il est interdit aux conducteurs d'autobus scolaire :

a) d'utiliser un autobus scolaire contrairement aux dispositions du *Code de la route* ou du présent règlement;

b) de laisser un autobus scolaire sans surveillance pendant que des élèves s'y trouvent, sauf lorsqu'ils doivent aider d'autres élèves à traverser une route;

(c) tow another vehicle, or permit the school bus to be towed, while pupils are on board;

(d) smoke, or allow any person to smoke, on the school bus while pupils are on board;

(e) refuel the school bus while pupils are on board;

(f) leave the school bus without setting the emergency brake;

(g) stop the school bus to receive or discharge pupils on a roadway where vehicle speed limits are 60 kilometres per hour or greater, when the school bus is not, under normal atmospheric conditions, clearly visible in its stopped position from the front or rear for a distance of at least 150 metres;

(h) allow pupils to stand while the vehicle is in motion;

(i) operate a school bus containing more pupils than the manufacturer's specified seating capacity;

(j) operate a school bus in which the aisle, entrance door or emergency door is obstructed in any manner; or

(k) operate a school bus in which wheelchairs are not secured with a device equivalent to the description in clause 4(j).

M.R. 139/95

### **Pupil instruction**

**17** The school board shall ensure that at least twice in each school year each pupil is instructed in safe school bus riding practices and participates in emergency school bus evacuation drills which shall be conducted at least once during the fall term and at least once during the spring term of each school year.

c) de remorquer un autre véhicule ou de permettre que l'autobus scolaire soit remorqué, pendant que des élèves s'y trouvent;

d) de fumer ou de permettre à quiconque de fumer dans un autobus scolaire pendant que des élèves s'y trouvent;

e) de faire le plein de carburant pendant que des élèves se trouvent dans l'autobus scolaire;

f) de quitter l'autobus scolaire sans avoir engagé le frein à main;

g) d'arrêter leur autobus scolaire sur une route où la limite de vitesse est d'au moins 60 kilomètres à l'heure afin d'y laisser monter ou descendre des élèves, si à l'endroit où l'autobus est arrêté l'avant et l'arrière du véhicule ne sont pas clairement visibles à une distance d'au moins 150 mètres, dans des conditions atmosphériques normales;

h) de permettre à des élèves de se tenir debout pendant que le véhicule est en mouvement;

i) de conduire un autobus scolaire dans lequel se trouvent plus d'élèves que le nombre de places assises spécifié par le fabricant;

j) de conduire un autobus scolaire si l'allée, la porte d'entrée ou la porte de secours sont obstruées de quelque façon que ce soit;

k) de conduire un autobus scolaire dans lequel les fauteuils roulants ne sont pas fixés au moyen d'un dispositif équivalent à celui mentionné à l'alinéa 4j).

R.M. 139/95

### **Enseignement des mesures de sécurité**

**17** La commission scolaire veille à ce que les mesures de sécurité applicables aux déplacements en autobus scolaire soient enseignées aux élèves à au moins deux reprises durant l'année scolaire et à ce que les élèves participent au moins une fois pendant la session d'automne et une fois pendant la session du printemps au cours de chaque année scolaire à des exercices d'évacuation d'urgence des autobus scolaires.

**Driver instruction**

**18(1)** The school board shall ensure that

- (a) each new school bus driver receives a minimum of 24 hours of instruction in school bus driver training prior to operating a school bus carrying passengers; and
- (b) each school bus driver receives a minimum of eight hours inservice training during each school year.

**18(2)** The instruction referred to in clause (1)(a) must:

- (a) include instruction about the role and responsibility of the school bus driver, passenger control, accidents and emergencies, bus maintenance and inspection, and driving fundamentals; and
- (b) be provided by a person who is certified as a School Bus Driver Instructor by the Pupil Transportation Unit of the Department of Education and Training.

M.R. 109/2000

**Log book**

**19** The school board shall ensure that each school bus is equipped with a vehicle log book, maintained in the form and manner prescribed by the minister.

**Formation des conducteurs**

**18(1)** La commission scolaire veille à ce que :

- a) les nouveaux conducteurs d'autobus scolaire reçoivent une formation d'au moins 24 heures sur la conduite des autobus scolaires avant de conduire un autobus scolaire transportant des passagers;
- b) les conducteurs d'autobus scolaire reçoivent au moins huit heures de formation en cours d'emploi durant chaque année scolaire.

**18(2)** La formation que vise l'alinéa (1)a) :

- a) porte notamment sur le rôle et les responsabilités du conducteur d'autobus scolaire, le contrôle des passagers, les accidents et les situations d'urgence, l'entretien et l'inspection des autobus ainsi que les techniques de conduite de base;
- b) est fournie par un instructeur titulaire d'un brevet de chauffeur d'autobus scolaire de la Section de transport des élèves du ministère de l'Éducation et de la Formation professionnelle.

R.M. 109/2000

**Journal de bord**

**19** La commission scolaire veille à ce que chaque autobus scolaire soit muni d'un journal de bord tenu en la forme et de la manière prescrites par le ministre.



**APPENDIX B1**  
**SCHOOL BUS SEATING PLAN SAMPLES - TEMPLATE 1**

---

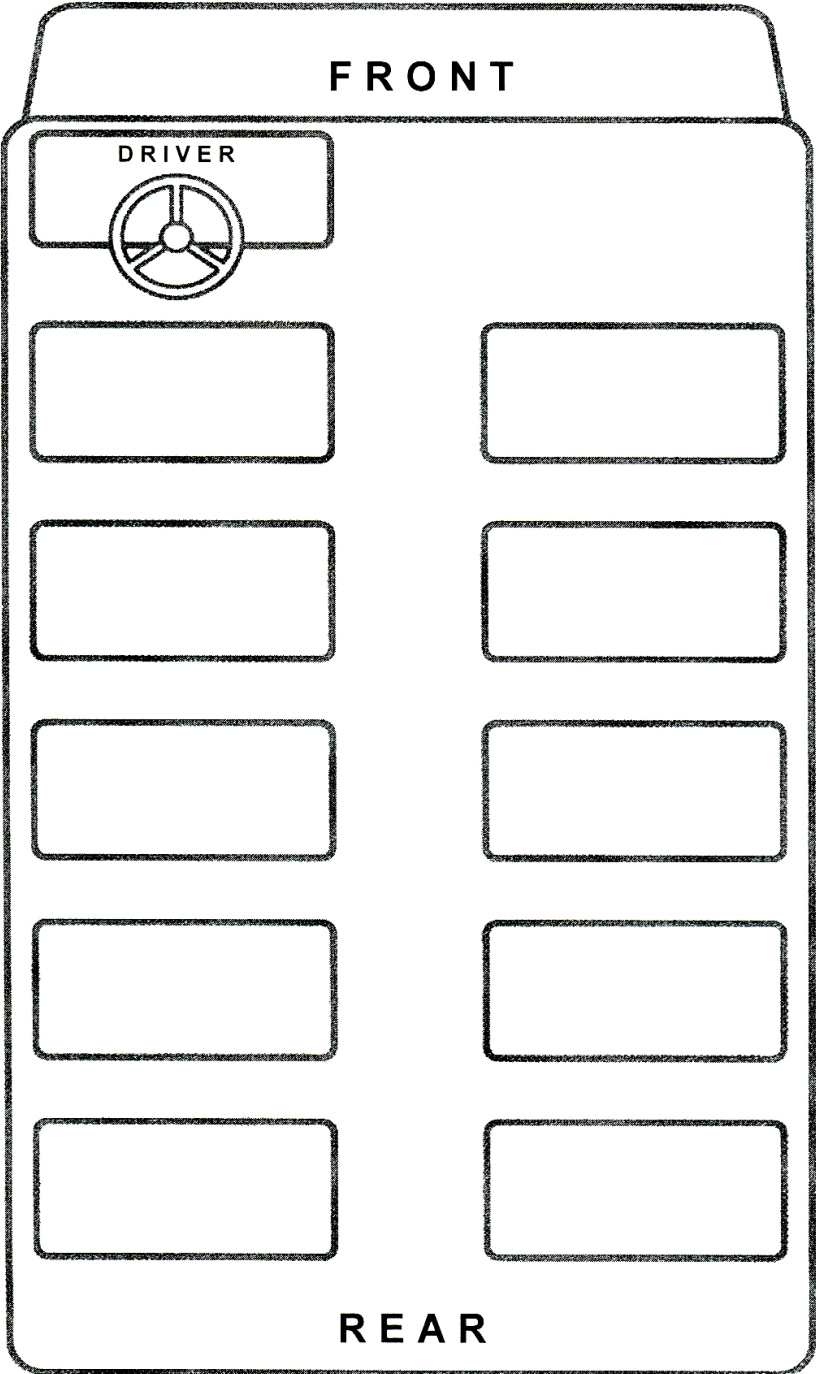

Date: \_\_\_\_\_  
Route  
Number: \_\_\_\_\_  
Bus  
Number: \_\_\_\_\_

**APPENDIX B1**  
**SCHOOL BUS SEATING PLAN SAMPLES - TEMPLATE 2**

Route No. \_\_\_\_\_ Bus No. \_\_\_\_\_ Date \_\_\_\_\_

LEFT SIDE SEAT ROWS			DRIVER'S SEAT	FRONT	RIGHT SIDE SEAT ROWS						
2W	Name:	2M	Name:	2A	Name:	1A	Name:	1M	Name:	1W	Name:
_____	_____	_____	_____	_____	_____	_____	_____	_____	_____	_____	_____
4W	Name:	4M	Name:	4A	Name:	3A	Name:	3M	Name:	3W	Name:
_____	_____	_____	_____	_____	_____	_____	_____	_____	_____	_____	_____
6W	Name:	6M	Name:	6A	Name:	5A	Name:	5M	Name:	5W	Name:
_____	_____	_____	_____	_____	_____	_____	_____	_____	_____	_____	_____
8W	Name:	8M	Name:	8A	Name:	7A	Name:	7M	Name:	7W	Name:
_____	_____	_____	_____	_____	_____	_____	_____	_____	_____	_____	_____
10W	Name:	10M	Name:	10A	Name:	9A	Name:	9M	Name:	9W	Name:
_____	_____	_____	_____	_____	_____	_____	_____	_____	_____	_____	_____
12W	Name:	12M	Name:	12A	Name:	11A	Name:	11M	Name:	11W	Name:
_____	_____	_____	_____	_____	_____	_____	_____	_____	_____	_____	_____
14W	Name:	14M	Name:	14A	Name:	13A	Name:	13M	Name:	13W	Name:
_____	_____	_____	_____	_____	_____	_____	_____	_____	_____	_____	_____
16W	Name:	16M	Name:	16A	Name:	15A	Name:	15M	Name:	15W	Name:
_____	_____	_____	_____	_____	_____	_____	_____	_____	_____	_____	_____
18W	Name:	18M	Name:	18A	Name:	17A	Name:	17M	Name:	17W	Name:
_____	_____	_____	_____	_____	_____	_____	_____	_____	_____	_____	_____
20W	Name:	20M	Name:	20A	Name:	19A	Name:	19M	Name:	19W	Name:
_____	_____	_____	_____	_____	_____	_____	_____	_____	_____	_____	_____
22W	Name:	22M	Name:	22A	Name:	21A	Name:	21M	Name:	21W	Name:
_____	_____	_____	_____	_____	_____	_____	_____	_____	_____	_____	_____
24W	Name:	24M	Name:	24A	Name:	23A	Name:	23M	Name:	23W	Name:
_____	_____	_____	_____	_____	_____	_____	_____	_____	_____	_____	_____
26W	Name:	26M	Name:	26A	Name:	25A	Name:	25M	Name:	25W	Name:
_____	_____	_____	_____	_____	_____	_____	_____	_____	_____	_____	_____
28W	Name:	28M	Name:	28A	Name:	27A	Name:	27M	Name:	27W	Name:
_____	_____	_____	_____	_____	_____	_____	_____	_____	_____	_____	_____

**EMERGENCY DOOR AT BACK OF BUS**

## APPENDIX B2

### SAFETY RULES FOR STUDENTS RIDING THE SCHOOL BUS

---

#### **Arriving at the Pick-up Point**

1. Be on time. Leave home in time to get to the bus stop before the school bus arrives.
2. If other students are waiting at the bus stop, get in line without crowding or pushing and stay off the road.

#### **Crossing a Road To Get To Your Bus Stop**

1. If you have to cross the road to reach your bus stop, stand on the opposite side of the road from the bus stop and wait for the bus to arrive.
2. Watch for the bus driver's signal that it is safe, check for traffic, then cross the road at least 3 metres/10 feet in front of the bus and ahead of the extended crossing arm.
3. Look left and right as you cross the road. At an intersection, look in all directions.
4. Always cross the road at right angles; don't cut across on an angle.
5. Walk quickly across the road, but don't run.
6. NEVER, cross the road BEHIND the school bus.

#### **Getting On the Bus**

1. Line up in single file with younger students in the front so they can board first.
2. Wait in line until the bus has stopped and the entrance door is fully open.
3. Board the bus quickly, but don't crowd or push other students.
4. Never run onto the bus as the steps may be slippery, especially in winter. Place your foot squarely on the steps, not the edges. Use the handrail.
5. Be careful getting on the bus if you are carrying books or other items because it's harder to see the steps and hold the handrail.
6. Go directly to your seat, face forward, and sit well to the back of the seat.

#### **Conduct on the Bus**

1. Stay in your seat for the entire trip.
2. Keep the aisle clear by placing books and other items on your lap or under the seat.
3. Avoid unnecessary discussion with the driver.
4. Avoid doing anything that might distract the driver or interfere with his or her driving.
5. Don't yell or talk loudly.
6. Don't open windows without the driver's permission.
7. Never, stick your head, arms, hands, or feet out the windows.
8. Don't throw anything inside the bus or out the window. You could hurt another passenger or a pedestrian, or create a dangerous situation for another driver.
9. Except in an emergency, don't touch the emergency door or exits or any part of the bus equipment.
10. Don't eat on the bus.
11. Obey the bus driver's instructions promptly. Remember: Your cooperation will help everyone stay safe.
12. If there are school bus captains on your bus, obey their instructions. They're there to help the driver and keep you safe.

## Getting Off the Bus

1. Stay in your seat until the bus has stopped and the entrance door is fully open.
2. Use the handrail when exiting the bus.
3. Be extra careful around the danger zones of the bus.
4. Move quickly away from the school bus to a safe location.

## Crossing a Roadway After Getting Off the Bus

1. If you have to cross the road after getting off the bus, walk along the edge of the road until you are at least 3 metres/10 feet in front of the bus, ahead of the extended crossing arm. Then, walk to the left front side of the bus, stop, and look both ways to make sure traffic has stopped and that it's safe to cross the road. Watch for the bus driver's signal that it's safe, check for traffic again, and cross the road.
2. Look left and right as you cross. At an intersection, look in all directions.
3. Always cross the road at right angles; don't cut across on an angle.
4. Walk quickly across the road, but don't run.
5. NEVER, cross the road BEHIND the school bus.

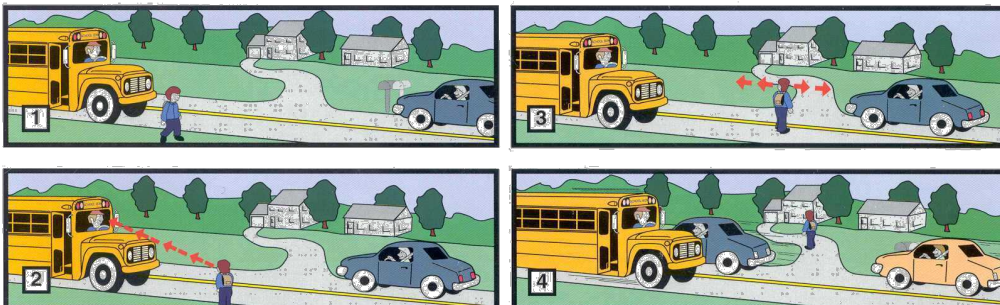
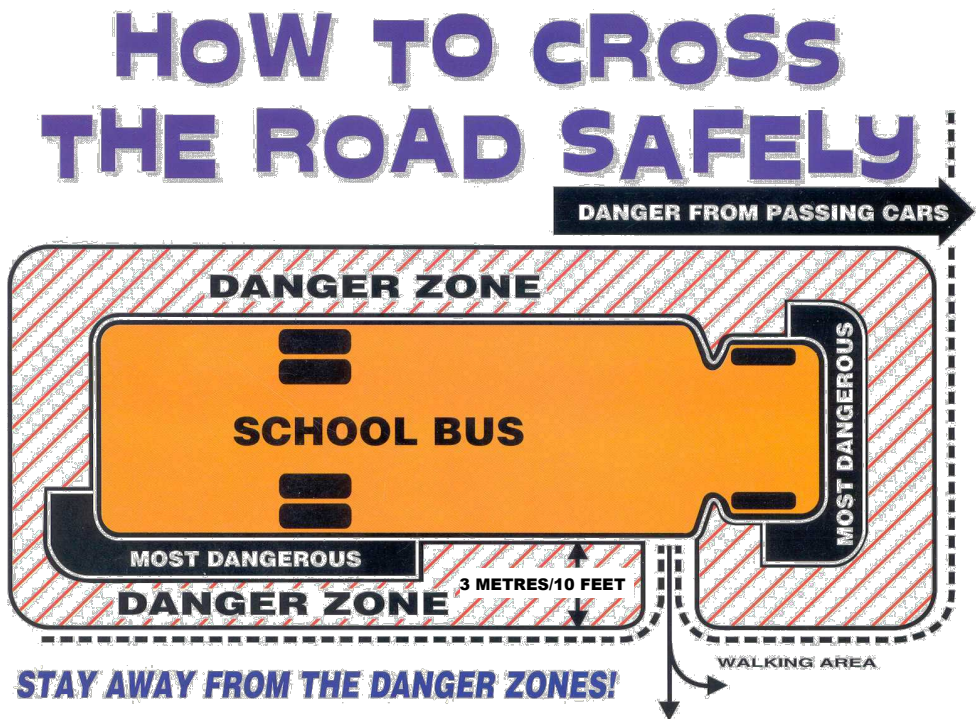





**The Public Schools Act**  
**Content of code of conduct**

- 47.1(2) A school's code of conduct must include
- (a) a statement that pupils and staff must behave in a respectful manner and comply with the code of conduct;
  - (b) a statement that the following are unacceptable:
    - (i) abusing, physically, sexually, or psychologically – orally, in writing or otherwise – any person,
      - (i.1) bullying,
      - (ii) discriminating unreasonably on the basis of any characteristic set out in subsection 9(2) of The Human Rights Code,
      - (iii) using, possessing or being under the influence of alcohol or illicit drugs at school;
  - (c) a statement that the following will not be tolerated on school sites:
    - (i) gang involvement
    - (ii) possessing a weapon, as “weapon” is defined in section 2 of the Criminal Code (Canada);
  - (d) a statement that pupils and staff must adhere to school policies respecting appropriate use of
    - (i) e-mail and the Internet, including policies that prohibit the accessing, uploading, downloading or distributing of material that the school has determined to be objectionable, and
    - (ii) digital cameras, cell phones, including those cell phones equipped with digital cameras, and other personal communication devices identified in the code of conduct;
  - (e) the disciplinary consequences, in as much detail as is reasonably possible, of violating the code of conduct, and the process for appealing disciplinary decisions; and meet any other requirements prescribed by regulation under The Education Administration Act.
-

## ***The Public Schools Act***

### **Reporting to the principal**

#### **47.1.1(1)**

The following persons must, if they become aware that a pupil of a school may have engaged in unacceptable conduct while at school, at a prescribed school-approved activity or in other prescribed circumstances, report the matter to the principal of the school as soon as reasonably possible:

- (a) an employee of a school board, school division or school district;
- (b) a person who has care and charge of one or more pupils during the prescribed school-approved activity.

### **Expanded duty to report cyberbullying**

#### **47.1.2(1)**

A person who is subject to a duty under subsection 47.1.1(1) must, if they become aware that a pupil of a school may have

- (a) engaged in cyberbullying; or
- (b) been negatively affected by cyberbullying;

report the matter to the principal of the school as soon as reasonably possible.

---

## **The Public Schools Act Responsibilities of pupils**

### **58.10**

The pupil is responsible for

- (a) attending school and classes regularly and punctually;
- (b) complying with
  - (i) the student discipline and behaviour management policies of the school and school division or school district, and
  - (ii) the school's code of conduct; and
- (c) completing assignments and other related work required by teachers or other employees of the school division or school district; and
- (d) treating school property and the property of others employed at or attending the school with respect.



**Pre-Trip Inspection Checklist**

**Outside Checks** → **Method Legend: V = Visual M = Manual A = Audible N/A = Not Applicable**

Item	Method	Proper Condition	Minor Defect	Out-Of-Service Defect
Manitoba Safety Inspection Decal	V	Legible; valid	N/A	Missing; unreadable; expired
Windshields	V	No damage; clear vision	Stars or chips less than 13 mm (1/2") or cracks less than 50 mm (2") in the wiper swept area	Damaged or deteriorated in such a way that driver's normal vision is materially impaired in the wiper swept area
Mirrors	V	No damage; secure	Insecure	Obstructed; fails to provide a clear view
Side Windows	V	No damage; clear vision	Leaking; cracked	Obstructing vision; shattered
Bumpers – Front & Rear	V; M	No damage; secure	Insecure; bolt missing	Missing; damaged; outside of body lines
Rear Emergency Door	M	Opens/closes	Buzzer not functioning; door hinges stiff to open	Door fails to open/close securely
Tires	V; M	Appear proper	Damaged tread or sidewall; tire leaking	Flat tire; tire tread depth less than wear limit; tire in contact with another tire or any vehicle component other than mud flap; tire marked "not for highway"; tire has exposed cords in the tread/outer sidewall area
Wheel Hub & Fasteners	V; M	Appear proper	Hub oil below minimum level (with sight glass); wheel seal seepage	Wheel has loose/missing/ineffective fastener; damaged/cracked/broken wheel/rim or attaching part; evidence of imminent wheel/hub or bearing failure
Suspension	V	No noticeable sag/lean	Seepage of shock absorber; air leak in air suspension system; suspension fastener loose/missing/broken	Shock absorber missing/damaged; deflated air bag; cracked/broken main spring leaf or more than one broken spring leaf; part of spring leaf/suspension missing/shifted out of place or in contact with another vehicle component; loose U-bolt
Air System	V; A	No damage; secure	Air seepage in air system	Audible warning operating; damaged part(s) of air system causing problems with air build-up
Bus Body & Frame	V; M	No damage; secure	Insecure/missing body parts; insecure/missing compartment doors; damaged frame/body	Visibly shifted/cracked/collapsing/sagging frame member(s); any exterior body panel damaged/deteriorated so that it causes a hazard to others
Brake Fluid Reservoir Level	V; M	Between minimum and maximum mark	Brake fluid level indicated at minimum level on reservoir	Below minimum level on reservoir
Coolant Level & Radiator Belts	V; M	Adequate level; drive belt(s) in place	Coolant level below add mark; coolant visible in reservoir; minor cracks in drive belt(s)	Leaks; no coolant visible in reservoir; drive belt(s) missing
Engine Oil Level	V; M	Operating level	Oil level at "add" mark on dipstick	Oil level below "add" mark on dipstick
Fuel System	V	No damage/leaks	N/A	Missing fuel tank cap; insecure fuel tank; dripping fuel leak
Licence Plate	V; M	Valid; secure	Loose	Invalid; missing

**Hydraulic Brake System**

Item	Method	Proper Condition	Minor Defect	Out-Of-Service Defect
Hydraulic Brake System	V; M; A	Functioning	N/A	Brake boost/power assist inoperative; brake fluid leak; brake pedal fade/ insufficient brake pedal reserve

**From Driver's Seat with Ignition Off (depress brake pedal)**

Item	Method	Proper Condition	Minor Defect	Out-Of-Service Defect
Hydraulic Brake Back-Up System	V; M; A	Functioning	N/A	Fails to operate

**Starting the Engine**

Item	Method	Proper Condition	Minor Defect	Out-Of-Service Defect
ABS Warning Light	V	No warning light	Warning light on (no ABS brakes)	N/A
Brake Warning	V; A	No warning light or buzzer	N/A	Activated warning device
Driver's Compartment	V; M; A	Pedals/gauges functioning properly	Instruments inaccurate/no free play in clutch (if applicable)	Accelerator sticking and engine fails to return to idle; activated bus chassis warning device; clutch fails to release
Neutral Safety Switch (if applicable)	V; M	Engine starts	Engine starts in gear	N/A
Mirror Adjustment	V; M	Properly adjusted	Fail to provide required view to driver due to damage/maladjustment	Crossover and/or rear view mirrors do not provide proper view
Steering	V; M	Functioning	Steering wheel lash (free play) greater than normal	Steering wheel insecure/does not respond normally; steering wheel lash (free play) exceeds prescribed limit

## Appendix C1

**With Engine Running, Check From Driver's Seat**      **Method Legend: V = Visual    M = Manual    A = Audible    N/A = Not Applicable**

Item	Method	Proper Condition	Minor Defect	Out-Of-Service Defect
Horn	M; A	Functioning	No operative horn	N/A
Defroster/ Heater Operation	M; A	Functioning	Control/system failure	Defroster motor fails to operate in all selected positions; airflow over intended area not present
Windshield Wiper/ Washer	V; M; A	Functioning	System or control does not work properly; wiper blade is damaged/ missing; wiper or washer does not work properly	Wiper or washer fails to adequately clear driver's field of vision in area swept by driver's-side wiper when prevailing weather conditions require use of wiper or washer
Park Brake	V; M	Functioning	Releases, but light stays on	Park brake won't release
Service Door Control	V; M	Operates properly	Operates unevenly	Door fails to open or close securely
Interior & Stepwell Lights	V; M	Operate properly	No more than one lamp not functioning	N/A

**Look Inside the Bus**

Item	Method	Proper Condition	Minor Defect	Out-Of-Service Defect
Driver's Seat & Seat Belt	M	Operate properly	Seat damaged/ripped	Seat belt/tether belt insecure/missing or malfunctions; fails to maintain selected adjustment
Passenger Seats	V; M	No damage; secure	Seat(s) damaged/ripped (move passengers if necessary)	Any seat or attaching fixture with a defect that may constitute a hazard to any person
Passenger Compartment	V; M	No damage	Stanchion padding damaged; damaged steps/slipping hazard; insecure/damaged overhead compartment	Interior body panels damaged/present a hazard to any person; passenger seat insecure
Emergency Exits (i.e. rear door; side windows; roof top)	V; M; A	Function properly	Buzzer inoperative	Emergency exits fail to function as intended
Fire Extinguisher	V; M	Secure; charged	Insecure	Missing/discharged (reading in gauge)
First Aid Kit	V; M	Secure; sealed	Insecure; seal broken	Missing
Fire Axe or Crow Bar	V; M	Secure	Insecure	Missing
Triangular Reflectors	V; M	Secure	Insecure	Missing/broken
Wheelchair Door/Latches	V; M; A	Opens/closes	Buzzer not functioning; door hinges stiff to open	Door fails to open/close securely
Wheelchair Lift	V; M; A	Functions properly	Wheelchair lift has uneven movement; lift operates slowly	Lift safety devices fail to function as intended; lift does not complete cycle; interlock system fails to activate/release as intended
Wheelchair Restraints	V; M	Function properly	N/A	Malfunction; absence of required passenger or mobility device restraints
Cargo Securement	V; M	Secure	Insecure	Failure/malfunction/deterioration of required items to be secured

**Outside Checks**

Item	Method	Proper Condition	Minor Defect	Out-Of-Service Defect
Crossing Arm	V	Functioning	Broken; sharp edges; fails to extend (priority: repair as soon as possible)	N/A
Stop Arm	V	Functioning	One lamp flashing	Lamps do not alternate; lamps inoperative; stop arm missing/damaged; stop arm will not extend fully or stay fully extended
Loading Lights	V	Functioning	One of eight lamps inoperative; cracked/fogged lens	Two or more lamps inoperative; lamps do not alternate
Turn Signals	V	Functioning	Front exterior lamps inoperative; cracked/fogged lens	Does not have at least one left and one right rear turn signal lamp
Daytime Running Lights	V	Functioning	Not operating as original equipment manufacturer designed	N/A
Headlights	V	Functioning	One low beam headlight inoperative; cracked/fogged lens	Failure of both low beam headlights
Stop Lights	V	Functioning	One of four lamps inoperative; cracked/fogged lens	Two or more lamps inoperative
Tail Lights	V	Functioning	One of four lamps inoperative; cracked/fogged lens	Two or more lamps inoperative
Marker/Clearance Lights	V	Functioning	Up to three lamps inoperative; cracked/fogged lens	More than three lamps inoperative
Back-Up Lights	V	Functioning	One lamp inoperative; cracked/fogged lens	More than one lamp inoperative
Hazard Warning Lamps	V	Functioning	Both front hazard lamps inoperative; cracked/fogged lens	Both rear hazard lamps inoperative
Exhaust System	V (with engine running)	Functioning	Exhaust leak except as described in <i>Out-Of-Service Condition</i> column; loose components	Exhaust leak causes exhaust gas to enter occupant compartment
Strobe Light	V	Functioning	Strobe light permit missing/ illegible; strobe light inoperative	N/A

**Appendix C1**

MONTH/YEAR: _____ / 20 _____				PRE-TRIP INSPECTION ON UNIT: _____			POST-TRIP INSPECTIONS ARE TO BE PERFORMED AFTER A.M. AND P.M. ROUTES ARE COMPLETED.			
Day	Odometer Reading	Fuel	Oil	Defect Report ("Nil" or List Defects)	Reported To (List name)	Driver Signature	Repaired (Mechanic Signature)	Date of Repair (Day/Month/Year)	Post-Trip Inspection	
									A.M.	P.M.

**NOTE: SUBMIT TOP COPY OF INSPECTION FORM TO DIVISION OFFICE EVERY 20 OPERATING DAYS.**





**APPENDIX C2**  
**CANADIAN MOTOR VEHICLE SAFETY STANDARDS - CMVSS 111**  
**MIRROR TESTING PROTOCOL**

---

**Annex A (normative)**  
**Mirror testing protocol**

**Note:** This Annex is a mandatory part of this Standard.

**A.1 Test conditions**

For the requirements specified in Clauses A.2 and A.3 to be met, the bus shall be tested as follows:

- a) The colour of the cylinders shall provide a high contrast with the road surface on which the bus is parked.
- b) Cylinders A, D, and E shall be 0.305 m (1 ft) high and 0.305 m (1 ft) in diameter; cylinders B and C shall be 0.915 m (3 ft) high and 0.305 m (1 ft) in diameter.
- c) The cylinders shall be placed at the following locations, and as shown in Figure A.1, with measurements taken from the centre of the cylinder, as viewed from above:
  - i) Cylinder A shall be placed in front of the bus so that its centre passes through the bus's longitudinal centreline and its top is directly visible through the wiped portion of the windshield at the driver's eye position.
  - ii) Cylinder B shall be placed on the side opposite the driver's side and at a point where the cylinder is entirely visible through the convex mirrors of both Systems A and B on that side so that its centre falls in a vertical plane that is 2 m (6.5 ft) to the right of, and perpendicular to, a vertical plane tangent to the bus's most outboard surface.
  - iii) Cylinder C shall be placed on the driver's side and at a point where the cylinder is entirely visible through the convex mirrors of both Systems A and B on that side so that its centre falls in a vertical plane that is 2 m (6.5 ft) to the left of, and perpendicular to, a vertical plane tangent to the bus's most outboard surface.
  - iv) Cylinders D and E shall be placed so that their centres fall in the vertical plane that passes through the centreline of the bus's rear-wheel axle. Cylinder D shall be placed on the side opposite the driver's side so that its centre falls in a vertical plane that is 2 m (6.5 ft) to the right of the bus's most outboard surface. Cylinder E shall be placed on the driver's side so that its centre falls in a vertical plane that is 2 m (6.5 ft) to the left of the bus's most outboard surface.
- d) For the purposes of Clauses A.2 and A.3, a driver's eye position shall be represented by the left and right eye points as defined in SAE J1050, and shall be at any place within the area defined by a 95<sup>th</sup> percentile eyellipse in accordance with SAE J941, with the following adaptations:
  - i) a 50/50 male-to-female ratio shall be used for the male/female mix;
  - ii) the term "heel point" used in SAE J941 and in other documents referenced in J941 shall mean "accelerator heel point" as defined in SAE J1100 (the position of the heel point be that determined by the manufacturer); and
  - iii) "seating reference point (SgRp)" has the same meaning as in SAE J1100.

- e) System A mirror and System B mirrors shall comply with Clauses A.2 and A.3 at any driver's eye position when they are adjusted in accordance with the manufacturer's instructions.
- f) Every mirror shall be adjusted to the driver's eye position in accordance with the manufacturer's recommendations and shall not be moved or readjusted during testing for that eye position but may be readjusted for subsequent tests for different eye positions.
- g) A still or video camera shall be positioned so that its image plane is located at the driver's eye point in such a manner that the reflective surface is visible to the camera through the windows of the bus.
- h) For a specific driver's eye position, the requirements of Clauses A.2 and A.3 shall be satisfied with the still or video camera positioned at the left or right eye point.
- i) The still or video camera shall be supported to allow pivoting in the
  - i) vertical and horizontal planes of its image plane to no greater than the maximum allowable limits of eye rotation specified in SAE J1050; and
  - ii) horizontal plane of its image plane to not greater than the maximum allowable limit of neck rotation specified in SAE J1050, at a point corresponding to the neck pivot point in accordance with SAE J1050, only after the maximum limits of eye rotation have been reached.
- j) All of the still or video camera observations shall be made with the service door of the bus closed and the stop signal arm fully retracted.
- k) For the purposes of Clause A.3.1, the front bumper shall be the forwardmost structural contour of the bumper (excluding the fasteners, protruding discrete bumper stops, and any attached accessories such as crossing control arms, which shall be removed before testing).
- l) Except in the case of a System B mirror installed on a school bus that has a forward control configuration, a mirror shall be installed so that the driver's field of vision through the mirror is not obscured by a portion of the windshield that is not wiped or by any opaque portion of the vehicle structure.
- m) For the purposes of Clause A.3.3, a comparison chart, such as the one shown in Figure A.2, may be used to measure the angular width and angular length of an image of a cylinder, where
  - i) the comparison chart is placed in a vertical plane that contains the image to be evaluated;
  - ii) the plane of the comparison chart is perpendicular to the line of sight;
  - iii) the images of the cylinder and the comparison chart are visible through the camera's viewfinder;
  - iv) a photograph is taken at the driver's eye position; and
  - v) the image of the cylinder is larger than the references shown on the comparison chart.
- n) All camera observations shall be made with the service door of the bus closed and the stop signal arm fully retracted.

## A.2 Side rear-view mirrors

System A shall consist of two sets of mirrors, one on each side of the bus, as follows:

- a) one set of mirrors of one unit magnification, with a reflective surface area of not less than 322.60 cm<sup>2</sup> (50 in<sup>2</sup>), that provides, at the driver's eye position, a field of vision that includes a continuous view rearward of the side of the bus and of the road surface. This view shall begin not farther than 60.93 m (200 ft) rearward of the mirror's surface and extend to the horizon when measured on a level road as illustrated in Figure A.1; and
- b) one set of convex mirrors that provides a field of vision, as illustrated in Figure A.1, that includes continuous and complete views at the driver's eye position, as follows:
  - i) rearward;
  - ii) of the ground;  
**Note:** This view overlaps the field of vision provided by the unit magnification mirror described in Item a).
  - iii) of the side of the bus;
  - iv) of cylinders B and D, placed in accordance with Clause A.1, in the mirror installed on the side opposite the driver's side; and,
  - v) of cylinders C and E, placed in accordance with Clause A.1, in the mirror installed on the driver's side.

The average radius of curvature of the convex mirrors referred Item b) shall be not less than 482 mm (19 in). The radius of curvature at any point shall not deviate by more than 12.5% from the average of any five radius-of-curvature measurements taken at least 6 mm (0.25 in) from the edge of the reflective surface.

## A.3 Crossover mirrors

### A.3.1

System B shall consist of one set of convex mirrors (one mirror on each side of the bus) that provides a field of vision that includes continuous and complete views at the driver's eye position, as shown in Figure A.1, of

- a) the ground from the front bumper forward to a point where direct observation is possible;
- b) the ground and the side of the bus rearward of the front bumper, extending to and overlapping the field of vision provided by the System A convex mirrors;
- c) cylinders A and B, placed in accordance with Clause A.1, in the mirror installed on the side opposite the driver's side; and
- d) cylinders A and C, placed in accordance with Clause A.1, in the mirror installed on the driver's side.

### A.3.2

Each System B mirror shall be installed so that the

- a) distance from the driver's eye position to the centre of the mirror is at least 95.25 cm (37.5 in);
- b) slope of the mirror surface has no discontinuities; and
- c) mirrors shall be below a horizontal plane passing through any driver's eye position.

### A.3.3

In addition to providing the field of vision described in Clause A.3.1, System B mirrors shall also comply with the following requirements concerning the angular size of the reflected images of cylinders A, B, and C:

- a) The shortest angular width of the image shall be not less than 3 min of arc, measured using the following equation:

$$X/D \geq 0.000873$$

where

X = the width of the image of the cylinder on the reflective surface  
D = the distance between the centre point of the driver's eye position and the centre of the reflective surface

0.000873 = the tangent of 3 min of arc

- (b) The shortest angular length of the image shall be not less than 9 min of arc, measured using the following equation:

$$X/D \geq 0.002618$$

where

Y = the length of the image of the cylinder on the reflective surface

D = the distance between the centre point of the driver's eye position and the centre of the reflective surface

0.002618 = the tangent of 9 min of arc

#### **A.3.4**

The images reflected in each System B mirror shall be located not less than 3 min of arc from the edge of the reflective surface, when measured at the driver's eye position.

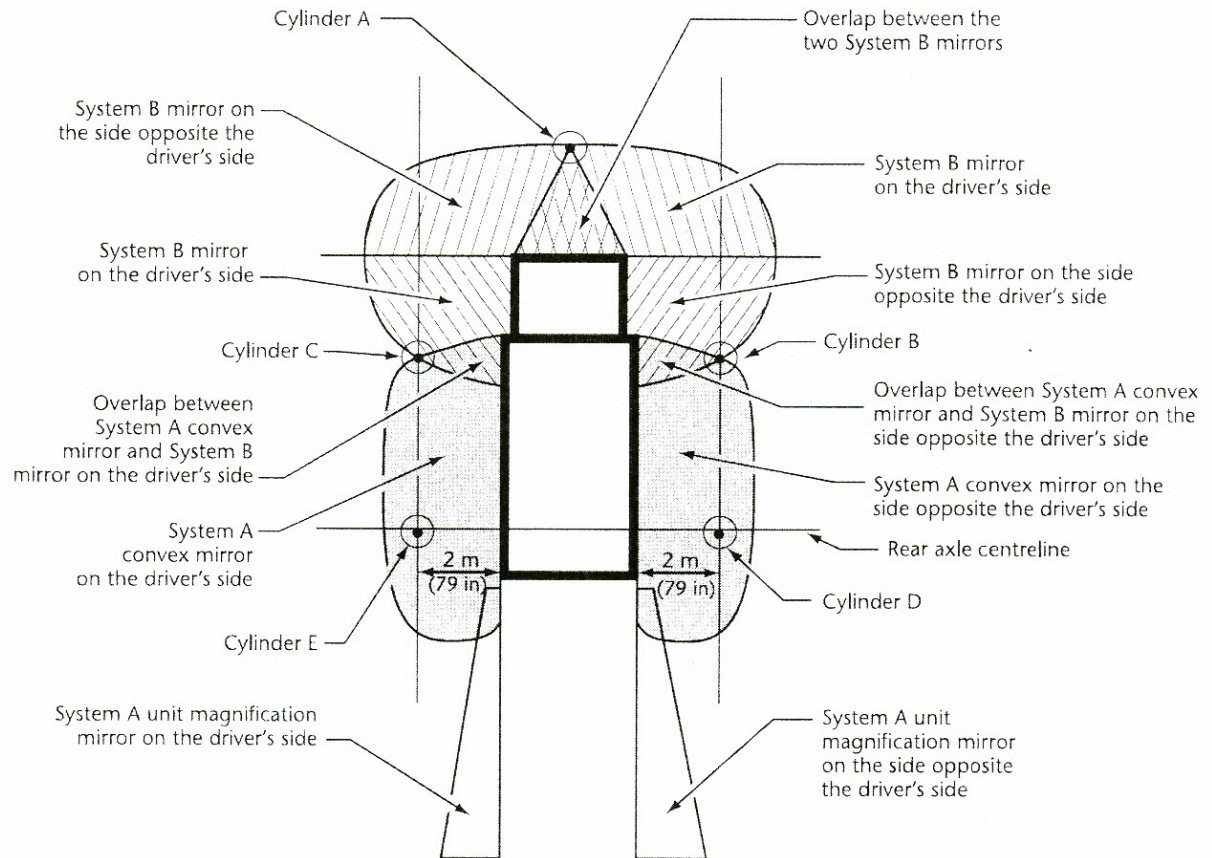

**Note:** Not actual size.

**Figure A.1**  
**Field of view of System A and System B mirrors**  
 (See Clauses A.1, A.2, and A.3.1.)

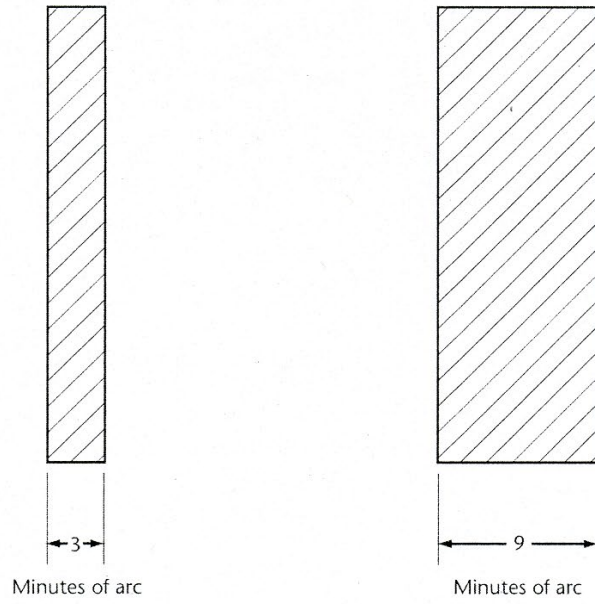

**Figure A.2**  
**Comparison chart**  
(See Clause A.1.)

**APPENDIX C3**

**ENGINE STARTING AND WARM-UP PROCEDURES FOR DIESEL ENGINES**

---

1. Set park brake, place gearshift in neutral, and depress clutch pedal if applicable.
2. Turn the key switch to the "run" position.
3. Notice the **"wait to start"** light. Do not crank the engine until the light goes off. If the engine is warm, the light may not come on. In extreme cold weather, it may be necessary to cycle the glow plugs or air intake heater (AIH) several times.
4. When the light goes out, turn the key to the "start" position. Release the key once the engine has started. When the glow plugs/AIH is hot, the engine is ready to start.
5. If a false start occurs or the engine runs for a short time and stops, turn the key switch to the "off" position, and then back on to the run position. Watch for the **"wait to start light" to** go out and attempt to restart the engine.
6. Check all gauges during the warm-up period. Do not leave the vehicle unattended during the warm-up period. (Refer to your school division's school bus idling policy regarding idling time permitted.)

**Important Notes . . .**

- \* **If the engine fails to start in 30 seconds, release the starter switch and wait two or three minutes to allow the starter motor to cool. If after three attempts the engine will not start, request assistance from service personnel.**
- \* **Do not increase engine speed until the oil pressure gauge indicates normal. Shut the engine down if the gauge does not register oil pressure within 20 seconds.**
- \* **EXPLOSION HAZARD WARNING: Do not use volatile starting aids such as ether, propane, or gasoline in the air intake system. The glow plugs/AIH will ignite the vapours and cause severe engine damage or personal injury.**
- \* **Follow the warm-up procedure as outlined by your school division.**

**Note: These are basic guidelines. Drivers should refer to the operator's manual for additional information or contact service personnel.**





## APPENDIX C4

### MANUAL TRANSMISSIONS - PREVENTIVE MAINTENANCE CHECKS

---

Check that all forward and reverse gears engage smoothly with no unusual metallic noises (clashing), smells (burning clutch), or shifting difficulties.

The clutch is the link between the engine and the transmission of the bus. The clutch connects the engine to the transmission when engaged, and disconnects the engine when the clutch pedal is depressed. The clutch is used extensively when upshifting a manual transmission. In some instances, it is used as a brake rather than a clutch. For example, drivers will stop on an incline and by "feathering" the clutch (letting the clutch part way out) it will hold the bus from rolling back. By so doing, the entire weight of the bus and its passengers is being held by the slipping clutch. This severe slipping generates excessive heat and causes undue wear of the clutch friction plate.

Another clutch component misused by some drivers is the throw-out bearing. The throw-out bearing does not turn when the clutch pedal is released. You have heard the term "riding the clutch". This occurs when the weight of a driver's foot rests on the clutch pedal with enough force to move the throw-out bearing forward until it makes contact with the pressure plate and it spins at the same speed as the engine. This serves no purpose except to increase wear and cause premature destruction of the bearing. The bearing is engineered to last a lifetime and is factory packed in grease sufficient to this usage. Undue use will deplete this grease and the bearing will burn out prematurely.

Ensure the clutch pedal has "freeplay". This refers to the amount of clutch pedal travel between its highest position and the point where you can feel contact being made. This clearance must be maintained to prevent the throw-out bearing from turning. On most equipment, this measurement should be approximately 1½" inches. Due to normal wear of the clutch disc, this clearance will decrease gradually and should be periodically adjusted by the mechanic to maintain proper freeplay.

A clutch assembly will provide trouble-free operation if the clutch is properly maintained and the vehicle is properly driven. Don't ride the clutch; don't use the clutch as a brake on hills; and when shifting, use it briefly and smoothly to achieve maximum clutch component life.

Proper use of the transmission can save wear and tear on not only the gears, but also on the clutch, engine, and brakes. With a manual transmission, always start the vehicle moving in low gear and at a slow rate of speed. This will insure proper lubrication of internal transmission and rear-axle parts and avoid the possibility of lugging the engine or slipping the clutch. As the vehicle's speed increases, progressively shift the transmission to the gear that will maintain the desired road speed. The following pointers should be considered when driving a vehicle with a manual transmission:

- ◆ Under heavy load conditions always start in first gear.
- ◆ On level ground with a four-speed transmission, use first through fourth gears.
- ◆ With a five-speed transmission under light, load conditions use second through fifth gears.
- ◆ When going uphill, downshift to avoid lugging the engine.
- ◆ When going downhill, use the same gear at the same speed that would be required to go uphill. This reduces the need for excessive downhill braking.
- ◆ Stop completely before shifting into first gear or reverse.



**APPENDIX C5**  
**SAMPLE SCHOOL BUS IDLING POLICY**

---

<b>Applicability</b>	This policy applies to the operation of every division-owned and/or contracted school bus.
<b>Rationale</b>	Diesel exhaust from idling school buses can accumulate in and around the bus and pose a health risk, both to children and drivers. Exposure to diesel exhaust can cause lung damage and respiratory problems. Diesel exhaust also exacerbates asthma and existing allergies, and long-term exposure is thought to increase the risk of lung cancer. Idling buses also wastes fuel and financial resources.
<b>Purpose</b>	Eliminate all unnecessary idling by (divisional) school buses such that idling time is minimized in all aspects of school bus operation.
<b>Guidance</b>	<ol style="list-style-type: none"><li>1. When school bus drivers arrive at loading/unloading areas to pick up or drop off passengers they should turn off their buses as soon as possible to eliminate idling time and reduce harmful emissions. The school bus should not be restarted until students are ready to load and there is a clear path to exit the pick-up area. Exceptions include conditions that would compromise passenger safety such as: (a) extreme weather conditions, or (b) the requirements of special needs students.</li><li>2. At the school bus yard, limit idling time during early morning warm-up to what is recommended by the manufacturer - generally 3 to 5 minutes. (In severe cold temperatures - 20 minutes).</li><li>3. Buses should not idle while waiting for students during field trips, extra-curricular activities, or other events where students are transported off school grounds.</li><li>4. In colder weather, schools are directed to provide a space inside the school where bus drivers who arrive early can wait.</li><li>5. In colder weather, if bus warmth is an issue, idling should be kept to a minimum and occur outside the school zone. The "warmed" bus should enter the school zone as close to pick-up time as possible to maintain warmth. There is an expectation that students will be ready to load when the bus arrives.</li><li>6. All drivers shall receive a copy of this bulletin at the beginning of each school year.</li></ol>



## **APPENDIX D1**

### **MANUAL TRANSMISSIONS – DRIVING FUNDAMENTALS**

---

#### **Shifting Gears**

Gear shifting is an element of driving requiring skill and practice. You must learn the best range of speed in changing gears upward and downward, and you must shift gears without losing view of the road. Tachometer readings may vary depending on the type of engine, transmission, gear ratio, and terrain. Downshift at a speed that will not make the engine RPM exceed governed speed.

Be sure you know the gear positions on your school bus. Check the chart on the lever knob or dash, or ask your supervisor.

#### **Fuel Economy**

For most school bus vehicles, maximum fuel economy can be obtained when road speed results in an engine, RPM that is 75% of maximum engine governed speed. When using any gear for a period of time (1 - 3 minutes), select the gear that will allow the engine to run at about 2700 RPM (75% of 3600 = 2700 RPM for gasoline engines). (Refer to engine manufacturer's recommendations for diesel engines.)

#### **Starting Procedures**

1. Ensure the park brake is on.
2. Depress the clutch pedal.
3. Shift the gear lever into starting gear. For average terrain and load, this should be second gear, although load and/or terrain may dictate use of first gear. Never start out in a gear higher than second as this places undue load, wear on the clutch, and will lug the engine.
4. Depress the service brake.
5. Release the park brake lever. If a ratchet type, pull the brake lever slightly back to release pressure.
6. Release the clutch gradually to the friction point and hold. At the same time release the service brake and depress the accelerator slightly to increase power and prevent stalling.
7. Gradually, release the clutch the remainder of the way and at the same time gradually increase your speed.
8. Remove your foot from the clutch pedal and keep your foot off the clutch pedal until you are ready to depress it again.
9. Increase vehicle speed before shifting to a higher gear.
10. Shift to the next gear. After depressing the clutch pedal and releasing the accelerator, make the shift. Release the clutch smoothly but more quickly than in starting gear and depress the accelerator smoothly and quickly to prevent loss of vehicle speed. Always remove your foot from the clutch pedal after completing a shift.
11. Proceed in this gear until proper speed is reached before shifting to the next gear.

Never skip a gear in up or down shifting as this causes engine and clutch wear. Shift up or down as necessary to prevent engine lugging or excessive engine RPM. Never allow the engine to pull heavily going uphill, in a turn, or on a curve. Lugging an engine will cause the valves and pistons to overheat, actually burning away parts of the valve and piston and destroying the engine. Don't let the engine over-speed on a downgrade. In preparation for, and prior to going downhill, shift into the gear that would be used in going up the same hill.

### **Making Right Turns**

1. Activate the right turn signal at least 30 metres/100 feet before the turn. On highways, signal at least 150 metres/500 feet before turning.
2. Reduce speed and downshift to the proper gear needed to execute the turn.
3. Position the bus to the right edge of the lane.
4. Check traffic signals and/or signs, and watch for pedestrians and vehicles positioned between the right side of the bus and the curb.
5. Check the right mirror and execute the turn smoothly without strain on the engine. Enter the right-most lane available and cancel the turn signal. Accelerate and move into the right lane as soon as possible. Remember to always signal a lane change.
6. Never, shift gears or depress the clutch during a turn.

### **Making Left Turns**

1. Activate the left turn signal at least 30 metres/100 feet before the turn. On highways, signal at least 150 metres/500 feet before turning.
2. Reduce speed and downshift to the proper gear needed to execute the turn.
3. Position the bus to the left edge of the lane. Check for a clear right of way. Vehicles making a left turn DO NOT have the right of way. Check traffic signals and/or signs, and watch for pedestrians and other vehicles. Use both outside mirrors and check especially carefully for vehicles attempting to pass the bus on the left side. If it is necessary for you to stop before making the turn, keep the front wheels straight and the brake pedal depressed. This stopping procedure will prevent your bus from being shoved into the path of oncoming traffic if you are struck from the rear.
4. Check the left mirror and execute the turn smoothly without strain on the engine. Enter the roadway in the left-most lane available and cancel the turn signal.
5. After completion of a left turn onto a multiple lane highway, accelerate and move into the right lane as soon as possible. Remember to always use the turn signal on a lane change.

### **Stopping When in a Low Gear or at 16 KMH (10 MPH) or Less**

1. Release the accelerator and when speed decreases to 8 - 5 KMH (5 - 3 MPH), depress the clutch pedal.
2. Apply the brakes gradually by increasing pressure.
3. To prevent jerking, reduce the brake pressure slightly, but not completely, just before coming to a stop.
4. Place the gearshift lever in the neutral position.
5. Engage the clutch and remove your foot from the clutch pedal.

## **Stopping When in Cruising Gear**

1. Release the accelerator and depress the brake pedal.
2. When the minimum speed is obtained for any gear, downshift to the next lower gear. The lower gear will tend to reduce heat build-up and excessive brake wear. Do not downshift more than two gears.
3. Downshifting can be very effective and smooth when third gear is used for the slowing action in a 5-speed transmission, and second gear in a 4-speed transmission. Example: When in fourth gear of a 5-speed transmission approaching a stop, downshift only one gear using third gear to slow the bus.

## **Starting on a Hill (Upgrade)**

When it is necessary to keep the bus from rolling backward on a hill, braking should never be done by "holding" the bus with the clutch and accelerator.

- ◆ Keep your right foot on the brake, your left foot depressing the clutch, and the shift lever in gear.
- ◆ Move your right foot to the accelerator and start normally, timing the clutch release, and brake release carefully to avoid stalling or rolling backward.
- ◆ It may be necessary to start in first gear if the hill is steep.

## **Stopping on a Hill (Upgrade)**

- ◆ Check following traffic.
- ◆ Apply the brake lightly for a smooth stop.
- ◆ Depress the clutch with your left foot; shift into neutral.
- ◆ Hold the bus with the service brake.
- ◆ Allow an extra safety margin between the bus and the vehicle ahead on an upgrade.

## **Stopping on a Hill (Downgrade)**

Stop as you would on an upgrade, except also downshift to reduce speed as you see the need to stop. On a downgrade, the transmission is in the same gear as it would be to power the bus up the hill.





**School Bus Traffic Offence Report**

*(print legibly and fill out all applicable lines)*

School Division: \_\_\_\_\_

Contractor: \_\_\_\_\_

**\*\* (for private contractors please indicate school division working for at time of offence) \*\***

Address: \_\_\_\_\_

Division Ph: \_\_\_\_\_

Bus/Unit #: \_\_\_\_\_

School Bus Driver Name: \_\_\_\_\_

Driver Ph: \_\_\_\_\_ (provide best number to be reached at)

**\*\*\* Information will not be disclosed, but is imperative to be included for police and Crown prosecutors to contact you \*\*\***

## Offence Information - please be as accurate as possible

Report Date / Time: \_\_\_\_\_

Completed by: \_\_\_\_\_

Bus video / imagery: (circle) YES NO

Occurrence Date: \_\_\_\_\_

Time: \_\_\_\_\_

Location (indicate nearest cross street): \_\_\_\_\_

\*\*\*\*\*

How was the vehicle identified? – (please circle)

By driver at time of offence / by driver after reviewing video

Vehicle Involved: License \_\_\_\_\_ Prov. \_\_\_\_\_

Type of Vehicle: SUV Truck Van Car M/C Semi

Description: (if available) 4 door 2 door Hatchback Other: \_\_\_\_\_

Color: \_\_\_\_\_

Make/Model (if known): \_\_\_\_\_

Identifying Marks: \_\_\_\_\_

.....

Was the driver observed at the time of offence? Yes No

Was the driver observed via video / imagery? Yes No

Driver description (if available): M or F Age: \_\_\_\_ Hair: \_\_\_\_\_ Other: \_\_\_\_\_

\*\*\*\*\*

\*\*\*\*\*

Verified Warning Lamps Working at both Pre-Trip / Post trip inspection Yes No

Direction of Vehicle Travelling: N S E W Street: \_\_\_\_\_

Bus Direction Facing: N S E W Street: \_\_\_\_\_

Bus Action: Loading or Unloading No. of Passengers: \_\_\_\_\_ Ages/Gr: \_\_\_\_\_

Amber Pre-warn Lights activated Y N Duration/Distance: \_\_\_\_\_

Bus Red Lights Flashing and Stop Sign Out: Y N How Long Activated \_\_\_\_\_

Any Obstructions of Stop Sign/Light: Y N (if so describe) \_\_\_\_\_

Was the offender (please circle) lone vehicle in line of traffic

Approximate speed \_\_\_\_\_ km / hr

\*\*\*\*\*

Road Way: 1 Way 2 Way Multi-Lane Divided Divided - Multi-Lane

Road Type: Hard Surface Gravel

Conditions: Dry Wet Icy Snow covered Muddy Other: \_\_\_\_\_

Weather: Clear Rain Snow Fog Dusty Other: \_\_\_\_\_

Visibility: Day Dawn Dusk Dark Street Lighted

\*\*\*\*\*

Narrative (describe occurrence):

---



---



---



---



---

Any notes taken please attach. If more space needed for narrative attach paper.

**Diagram of Occurrence:** (attach on separate sheet if needed)



**N**

By signing below, I declare the above information of the traffic offense are correct and may be used in court. Furthermore, I understand that by submitting this form I may be required to provide testimony in court regarding this offence.

**Driver Signature:** \_\_\_\_\_ **Date:** \_\_\_\_\_

.....  
**ADMINISTRATION:**

Video verified Yes No    Time/Date stamp correct: Yes No

Report reviewed and approved by: \_\_\_\_\_ (print clearly)

Signature: \_\_\_\_\_ Date: \_\_\_\_\_

**APPENDIX D3**  
**THE HIGHWAY TRAFFIC ACT – RAILWAY CROSSINGS**

---

SPECIAL STOPS

**Definitions 134(1)** *The following definitions apply in this section.*

**"flag person"** *includes a crew member of a railway train who, in connection with the train's operation, directs traffic or warns people on a highway.*

**"uncontrolled railway crossing"** *means a railway crossing at which traffic is not controlled by a "stop" or "arrêt" sign, an electrical or mechanical traffic control device, a crossing gate or a flag person, but does not include an industrial spur railway crossing within a restricted speed area.*

**Stopping at railway crossings 134(2)** *The driver of a vehicle approaching a railway crossing shall stop the vehicle before proceeding across the crossing if*

- (a) a "stop" or "arrêt" sign is erected at the crossing; (b) a clearly visible electrical or mechanical traffic control device at the crossing is signalling the proximity or passing of a railway train; (c) a crossing gate is lowered or partly lowered, or a flag person is signalling the proximity or passing of a railway train; or (d) a railway train is in dangerous proximity to the crossing and is giving an audible signal or is visible.

**Stopping at uncontrolled railway crossings**

134(3) *Without limiting the application of subsection (2), a driver must also stop before proceeding across (a) a controlled or uncontrolled railway crossing if the driver is driving a school bus, whether or not it is carrying passengers; or (b) an uncontrolled railway crossing if the driver is driving (i) a bus carrying passengers for compensation, or (ii) a vehicle designed or used to carry flammable liquid or gas, whether or not it is empty.*

**Additional requirements for particular vehicles**

134(4) *While a vehicle described in subsection (3) is stopped as required by subsection (2) or (3), the driver must (a) look in both directions along the railway track for an approaching railway train; (b) listen for signals indicating the approach of a railway train; and (c) if the vehicle is a bus or school bus, open the door of the vehicle.*

**Required stopping distances — certain buses and trucks**

134(5) *In a case mentioned in subsection (2) or clause (3)(b), the driver of a vehicle mentioned in subclause (3)(b)(i) or (ii) must stop the vehicle (a) not less than 5 m from the rail of the crossing nearest the vehicle's front if the crossing is in a restricted speed area; or (b) not less than 15 m from the rail of the crossing nearest the vehicle's front in any other case.*

**Required stopping distances — school buses**

134(5.1) *In a case mentioned in subsection (2) or clause (3)(a), the driver of a school bus must stop it at the distance from the railway crossing prescribed in the regulations about school buses made under The Public Schools Act, whether or not (a) the school in connection with which the school bus is operated is a school to which that Act applies; and (b) those regulations apply to the school bus in the absence of this subsection.*

### **Proceeding across a railway crossing**

134(6) After stopping, the driver shall not proceed unless he or she can do so safely and without stopping before clearing the crossing, and (a) in a case described in clause (2)(b), unless (i) the electrical or mechanical traffic control device is no longer signalling the proximity or passing of a railway train, or (ii) a peace officer or flag person directs the driver to proceed;(b) in a case described in clause (2)(c), unless (i) the crossing gate is completely raised or the flag person is no longer signalling the proximity or passing of a railway train, or (ii) a peace officer or flag person directs the driver to proceed; and (c) in a case described in clause (2)(d), unless the railway train is no longer in dangerous proximity to the crossing.

### **Proceeding when train is stopped**

134(7) Despite clause (6)(a), a driver who stops at a railway crossing because an electrical or mechanical traffic control device is signalling the proximity of a railway train may proceed across the crossing if the train is stopped, or is not in close proximity to the crossing, and if he or she can do so safely and without stopping before clearing the crossing.

### **Changing gear while crossing track prohibited**

135 The driver of a vehicle described in clause 134(3)(a), (b) or (c) shall not (a) cross the track of a railway crossing in a gear that he or she will need to change while crossing the track; or (b) change gears while crossing the track.

### **Stopping vehicle within railway crossing prohibited**

135.1 No person shall stop a vehicle (a) within a railway crossing; or (b) in a location where any part of the vehicle is over a track in a railway crossing.

## **Loading and Unloading at Turnarounds**

More student fatalities occur while getting on or off a school bus each year than as passengers inside a school bus. Data shows that students are more likely to be fatally injured or injured by their own bus than vehicles passing by. As a result, knowing what to do before, during, and after loading or unloading students is critical. You are required as the driver, to have a full understanding of the procedure to use and confirmed by your division.

### **Turnaround Bus Stops (if applicable in your division)**

The turnaround procedure is more prevalent in rural areas. If you are required to perform a turnaround, students must be on the bus before proceeding any manoeuvre. The reason for this is the student's visibility to the driver should not be compromised and it is a major hazard if the student cannot be seen. Driver is to confirm the turnaround procedure to be use with the local school division.

The need for a turnaround at a designated pick-up/drop-off location (residence) can sometimes be avoided with proper route planning, or by extending a route to an alternate turnaround location. In situations without an alternative where a turnaround must be performed, there are several determining factors to consider:

1. The bus should be clearly visible for 150 metres in both directions
2. Road and weather conditions (e.g. surfaces, widths, angles, slopes, obstructions)
3. Traffic volume
4. School bus driver's visibility and capabilities
5. Size of the school bus and possible damage to a turnaround location

Keeping these factors in mind, there are various ways to perform a turnaround. Each turnaround situation is unique; therefore, the school division's transportation supervisor should be consulted regarding each turnaround procedure. As a driver, you have the responsibility to inform your supervisor when a turnaround presents a hazard. The following three methods provide guidelines for performing a turnaround.

### **Method 1: Drive In and Reverse Out**

Where possible and safe to do so at a turnaround location, driving forward into a driveway or approach. This procedure gives the school bus driver the best field of view of a student's location as they are being picked up or dropped off. This method ensures that students are not in the danger zones or blind spots of the driver. In addition, students are not required to cross the roadway.

This method requires that the driveway or approach being turned onto is sufficient for the size of the bus, will not sustain significant damage from the large vehicle, and that sight lines are suitable for the school bus driver to reverse safely. Traffic volumes

should be such that the school bus driver has the opportunity to complete the turnaround safely.

### **Benefits To Driving In, Reversing Out . . .**

- Students are not required to cross a roadway - they are in full view of the school bus driver and do not have to enter the danger zone.
- Through road, traffic is not required to stop for the flashing loading lights/stop arm.
- During morning loading procedures, students are on the school bus while reversing is performed.
- During afternoon drop-off procedures, the student exits the school bus and heads directly towards their residence, away from the school bus, in full view of the driver.

### **Method 2: Turnaround Performed Elsewhere**

Where possible and safe to do so, this method can be performed away from the student's designated stop location. It would require a safe/sufficient turnaround not too far from the designated stop. Traffic volumes and visibility should be such that the bus driver can perform the turnaround safely. With this method, students would be picked up/dropped off as with any regular roadside pick-up/drop-off. In some cases, it may be best for students to be loaded prior to the turnaround. As a driver, you must consult with your supervisor on the safest procedure.

Once at the turnaround location use the following procedure to safely execute the manoeuvre:

- Move the bus to a position on the roadway one-bus length ahead of the driveway or approach where you will back the bus to complete the turnaround.
- Activate hazard-warning lights.
- Check traffic front and rear. Ensure there is a sufficient gap in traffic to permit the backing manoeuvre.
- Back into the driveway or approach using the outside rear-view mirrors.
- Once the backing manoeuvre is complete and you are ready to drive forward signal your intent to turn and proceed onto the roadway when safe to do so.

### **Benefits To Performing the Turnaround Elsewhere . . .**

- Potentially a more accessible/safer turnaround location may be selected.
- Students are never around the exterior of the school bus while reversing.
- The school bus driver is using standard loading/unloading procedures.
- Students are not exposed or required to enter the danger zones around the school bus while the bus is reversing



### **Method 3: Reverse Turnaround at Designated Stop Location during Loading/ Unloading**

Method Three involves the school bus reversing into a driveway or approach at the designated stop to load/unload students and then re-entering the roadway from where it came. If this method must be used, procedures can be put in place to increase student safety.

Where the school bus must reverse into a turnaround with students present, it is important that students be loaded prior to the reverse turnaround. Where students are exiting the school bus, the entire turnaround procedure can be performed and once the bus has returned to the roadway students can exit the school bus to a safe location. Students can then be directed to wait for the bus to leave before proceeding.

In special circumstances, if students enter or exit the school bus in mid-turnaround, students must be instructed to wait in a safe location (out of the danger zone) while the bus is starting the reverse turnaround. Then, once stopped and receiving the signal from the driver, the students may proceed to enter the bus. It is important to note that with this loading/unloading procedure the school bus will be reversing in the presence of students, therefore increasing the risk to students who may be entering the danger zone on the side of the school bus and/or immediately behind the school bus. The school bus driver's view is limited in these areas therefore extreme caution must be taken. As students exit the bus they are to be instructed to wait in the safe location until, the bus is off the driveway. Refer to Unit D Making a Turnaround section for more details.



## **APPENDIX F1**

### **MANUAL TRANSMISSIONS – BRAKE LOSS**

---

You are driving along the roadway, you step on the brake pedal to slow down or stop, and the pedal sinks slowly to the floor. What should you do?

1. Pump the brake pedal. If only partial failure has occurred, pumping the brake pedal may achieve partial braking force.
2. Downshift through the gears. Allow the engine compression to slow you down and stay on the road. Select a clear path for leaving the stream of traffic and guide the bus to the shoulder of the road. On buses equipped with a manual park brake, gradually apply the park brake to bring the bus to a complete stop. It should be noted that on some newer school buses, the park brake might not be applied while the bus is in motion. Check with service personnel.
3. If you must leave the road to avoid a crash, select a path that will minimize injury and property damage. Look for something to sideswipe that will slow you down - a roadside bush, snow bank, guardrail, even parked cars. If you must go into a steep ditch, try to enter at an angle, which will not cause the bus to overturn.
4. If the brakes fail in an urban area in heavy traffic, turn off the ignition to kill the engine. With the transmission in gear and the clutch engaged, apply the park brake.



## School Bus Driver Electrical Safety

### Dealing with an electrical accident

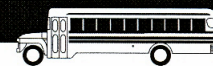

### Prevention

The best way to prevent accidental contact with power lines is to check carefully for hazards **before** you drive your route at the start of a new term. This is most important if you are going to be on a new route.

1. **Be sure you can turn safely** in either a farm yard or school yard. Make sure you can back up or make a loop turn without coming into contact with guy wires or poles.

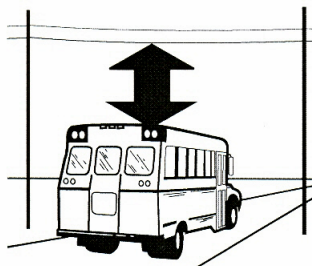

2. **Check clearances** between overhead power lines and the top of the bus. If a hydro pole is leaning, it could mean that the line is lowered enough to come into contact with your school bus. Report such a situation to Manitoba Hydro as soon as possible.

### Contact with an Energized Power Line

Should your school bus accidentally come into contact with an energized power line, **take these steps**:

1. Use your radio to call for assistance or have someone outside the bus go for help.
2. If safe to do so, back the bus away from contact with the lines.
3. If you can't back away from contact, remain on the bus. You and your passengers could be exposed to danger of electrocution if you try to leave the bus.
4. Keep others at least 15 metres or 50 feet away from the accident site.
5. **Never** touch a wire. All wires are energized.



### Contact with a Power Line and Fire

Should your bus come into contact with a power line that causes a fire on the bus, **here are the steps to follow**:

1. Try to back away from the contact with power lines.
2. Next evacuate the bus. To do this have the students hop clear of the bus. Make sure their arms are kept tightly at their sides. Tell them to jump clear without touching the bus and the ground at the same time. They must land with their feet together and hop with their feet still together a safe distance away from the bus.
3. Keep the students together in a group. Keep students and onlookers away from the site.
4. Be sure someone calls Hydro for assistance.

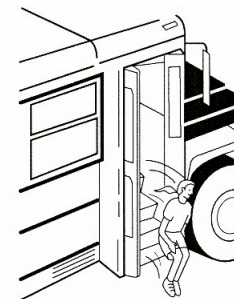

### Encountering an Accident

If you come across a vehicle that has come into contact with power lines – and someone is still in the vehicle – there is only one course of action to take.

**GET HELP AS QUICKLY AS POSSIBLE.**

**DO NOT TOUCH THE VICTIM OR THE VEHICLE.**

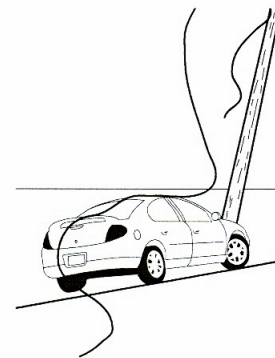

This information contained herein is published as a convenient reference for Manitoba Hydro customers and is distributed without charge. While every effort has been made to provide accurate and complete information, Manitoba Hydro does not warrant the accuracy or efficiency thereof. Manitoba Hydro will not be liable for any loss, costs, damage or injury whatsoever, resulting from the use of this material.

*Cette information existe également en français*



# School Bus Accident Report

School Bus Accident Reports are to be submitted to the Pupil Transportation Unit (PTU) whenever a school bus is involved in a major accident.

The school bus driver involved in the accident should complete the Report (with assistance if required), and it should be reviewed by the school division transportation supervisor or designate for accuracy.

Submit the completed report to PTU by email to [ptu@gov.mb.ca](mailto:ptu@gov.mb.ca) or by fax at 204-948-2154.

**Report Submitted By:**

---

Name and Position

---

School Division

---

Date (DD-MM-YYYY)

**GENERAL ACCIDENT INFORMATION**

School Bus Unit Number: \_\_\_\_\_

Accident Date: \_\_\_\_\_ Day of Week: M T W Th F Sa Su

Accident Location (e.g. street, highway number, driver's residence): \_\_\_\_\_

Town/City: \_\_\_\_\_ **OR**  On rural route

Time of Accident: \_\_\_\_\_  a.m.  p.m. Number of Students on Bus (excluding driver): \_\_\_\_\_

Type of Bus:  Van (Type A1)  Van (Type A2)  Handi-Transit (Type A1)  Conventional (Type C)  Flat nose (Type D)

School Bus Use at Time of Accident:  Regular route  Maintenance/Fueling  Special education  Off duty  Field trip  Other (specify) \_\_\_\_\_

**SCHOOL BUS DRIVER INFORMATION**

Driver's Name: \_\_\_\_\_

School Bus Driver Experience:

Less than 1 year  3-5 years  More than 10 years  
 1-2 years  6-10 years

Number of school bus accidents in past three years: \_\_\_\_\_

Did driver receive 24 hours of school bus operator instruction prior to being certified?

Yes  No

Has driver received eight hours of inservicing in the past 12 months?  Yes  No

**AT TIME OF ACCIDENT**

Posted speed limit: \_\_\_\_\_ km/h **OR**  Not applicable

Approximate speed of bus: \_\_\_\_\_ km/h **OR**  Stopped

Was driver wearing seat belt?  Yes  No  Driver off bus at time of accident

Is bus strobe light equipped?  Yes  No Was it activated at time of accident?  Yes  No

Were the police notified?  Yes  No Was a police report completed?  Yes  No

1. Accident involved school bus and:

- |   |  |
|---|--|
| <input type="checkbox"/> Another motor vehicle        | <input type="checkbox"/> Pedestrian            |
| <input type="checkbox"/> School bus only              | <input type="checkbox"/> Cyclist               |
| <input type="checkbox"/> Fixed object (specify) _____ | <input type="checkbox"/> Train                 |
| <input type="checkbox"/> Animal                       | <input type="checkbox"/> Other (specify) _____ |

2. Amount of damage to all property involved (i.e. vehicles and/or other objects):

- No damage                       \$1,000 or less                       More than \$1,000

3. Did accident occur at an intersection?

- Yes                       No

4. Type of collision between vehicles or objects:

- |                                     |  |
|-------------------------------------|--|
| <input type="checkbox"/> Angle      | <input type="checkbox"/> One vehicle backing   |
| <input type="checkbox"/> Head on    | <input type="checkbox"/> Rollover              |
| <input type="checkbox"/> Rear end   | <input type="checkbox"/> Other (specify) _____ |
| <input type="checkbox"/> Side swipe |  |

5. Direction of vehicles at time of accident:

- |  |   |
|--|---|
| <input type="checkbox"/> Angle, both moving              | <input type="checkbox"/> One vehicle stopped            |
| <input type="checkbox"/> Same direction, both moving     | <input type="checkbox"/> Single vehicle accident        |
| <input type="checkbox"/> Opposite direction, both moving | <input type="checkbox"/> Vehicle direction not a factor |

6. Contributing Circumstance(s):

Bus Driver Actions

- Improper speed
- Failed to yield right of way
- Failed to obey stop sign
- Failed to obey traffic signal
- Crossed centre line
- Improper passing
- Improper turning
- Improper backing
- Followed too closely

Other Circumstances

- Actions of other driver
- Obstructed view
- Weather conditions/visibility
- Vehicle defect (specify) \_\_\_\_\_
- Road conditions (specify) \_\_\_\_\_
- Other circumstance (specify) \_\_\_\_\_

7. Weather Conditions/Visibility:

- |   |  |
|---|--|
| <input type="checkbox"/> Clear          | <input type="checkbox"/> Snow/sleet            |
| <input type="checkbox"/> Cloud/overcast | <input type="checkbox"/> Haze/smoke            |
| <input type="checkbox"/> Rain           | <input type="checkbox"/> Exhaust fog           |
| <input type="checkbox"/> Fog            | <input type="checkbox"/> Other (specify) _____ |

8. Road Surface:

- Pavement                       Gravel                       Dirt

9. Road Condition:

- |                                |  |
|--------------------------------|--|
| <input type="checkbox"/> Dry   | <input type="checkbox"/> Snow packed           |
| <input type="checkbox"/> Wet   | <input type="checkbox"/> Potholes/ruts         |
| <input type="checkbox"/> Muddy | <input type="checkbox"/> Under repair          |
| <input type="checkbox"/> Icy   | <input type="checkbox"/> Other (specify) _____ |

10. Lighting:

- |                                   |  |
|-----------------------------------|--|
| <input type="checkbox"/> Dawn     | <input type="checkbox"/> Dark                            |
| <input type="checkbox"/> Daylight | <input type="checkbox"/> Dark, artificially illumination |
| <input type="checkbox"/> Dusk     |  |

11. Identify point of impact.

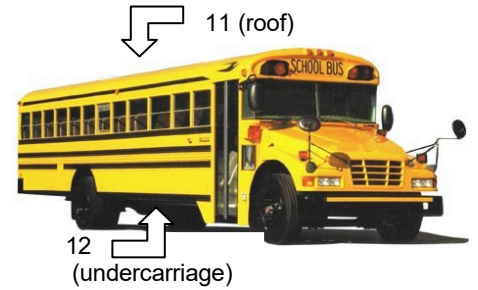
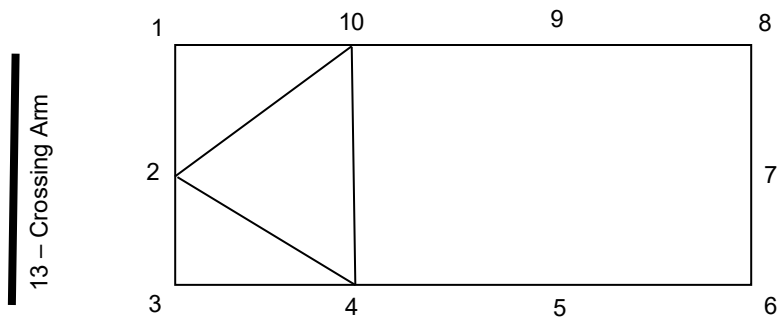

14 No impact/other circumstance. What? \_\_\_\_\_

12. Please provide a brief description of the accident, and if it assists with the explanation, complete the accident sketch below.

---

---

---

---

---

---

---

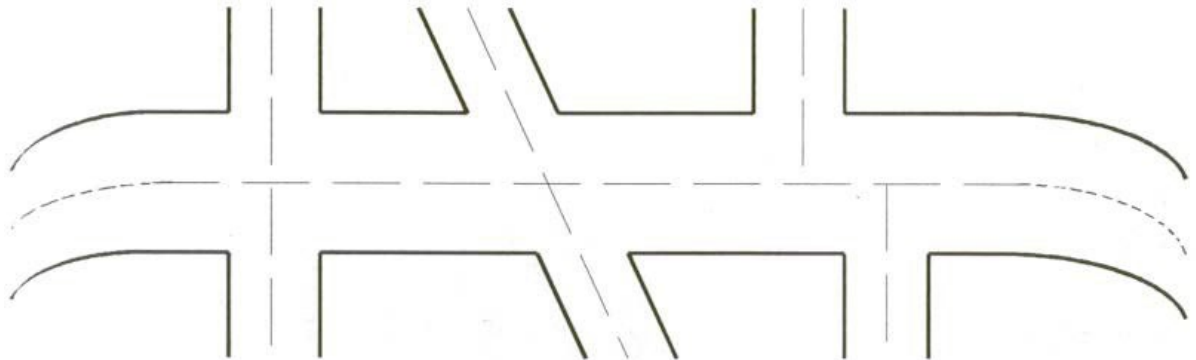



**COMPLETE ONLY IF ACCIDENT OCCURRED WHILE LOADING/UNLOADING**

13. At time of accident, was the bus:

- Entering the loading area     Stopped in the loading area     Leaving the loading area

14. Did a “don’t pass law” violation occur?

- Yes                       No

15. Was anyone injured in this accident?

- Yes                       No

Was the pupil/other person injured in the loading area:

- Struck by the bus             Struck by another vehicle             Other circumstance (specify) \_\_\_\_\_

**COMPLETE ONLY IF ACCIDENT INVOLVED A PEDESTRIAN/CYCLIST**

16. Direction of bus at time of accident:

- Straight                                       Backing  
 Turning right                               Bus stopped  
 Turning left                                       Other (specify) \_\_\_\_\_

17. At time of accident, the pedestrian/cyclist was:

- On the side of the road                       In a crosswalk  
 In the roadway                                       Other (specify) \_\_\_\_\_

**COMPLETE ONLY IF ACCIDENT RESULTED IN INJURY**

Severity of Injury	Number of Injured ON Bus			Number of Injured OFF Bus		
	Students	Driver	Other Passengers	Students	Driver	Other Passengers
Minor						
Moderate						
Serious						
Fatal						



## **Driver's First Response before Performing an Evacuation**

- Remain calm, do not panic
- Secure the bus by setting the park brake, placing the transmission in neutral and turning the ignition key to accessory position. If your radio is on at all times, turn ignition key to off position and remove key.
- Remind students to remain calm and stay seated
- Assess the situation and what action to take
- Radio dispatch with details of incident - nature of situation, location of bus and if assistance is required. Police, Fire or Ambulance.
- Hang the two-way radio mic out the driver's window. This is only necessary if your two-way radio works with ignition key removed and the cord is long enough
- Remove the ignition key if not already done so
- Identify a safe location for students to meet 30M/100ft from bus. Look for an object such as a tree, fence post, building etc.
- Check for injured students if necessary
- Announce clearly, the evacuation procedure and evacuation start point (front or back of bus)
- **Driver is the last one out after ensuring all students are off the bus**

## **Front Service Door Evacuation**

- Instruct students to evacuate using the front service door
- Captain/Leader to exit first and confirm the safety location to lead remaining students
- Students to leave all belongings on bus
- Remind students to use handrails when exiting
- Students to exit quickly from either front or back of bus (pending on scenario) using the zipper pattern at 2 - 2½ second intervals (one side, other side, next row)
- Proceed directly to the 30M safe point and stay in group setting
- Driver to walk through the bus verifying all students have evacuated
- Grab first aid kit, manifest and join students
- If cell phone present contact division on status of incident

**Rear Emergency Exit Door Evacuation**

- Instruct students to evacuate using the rear emergency exit door
- Identify a safe location for students to meet 30M from bus. Look for an object such as a tree, fence post, building etc.
- Captain/Leader to confirm the safe location to lead remaining students to safety
- The leader will open the rear emergency door, exit and ready to lead passengers to a safe location as pointed out by the driver
- The two helpers will take their positions, one on each side of the rear door, to assist passengers out of the bus in a safe, orderly manner
- Students to leave all belongings on bus
- Depending on scenario start evacuation from back or front - one side at a time or alternating sides at 2 – 2½ second intervals
- Helpers will present a hand, palm upwards, and avoid grasping or locking fingers of exiting passengers
- Student to sit to the edge and grasp the helper's hand and scoot out of the bus (this is known as a sit and scoot method)
- Each passenger should be two steps away from the rear of the bus before the next person exits.
- Proceed directly to the 30M safe point and stay in group setting
- Driver to walk through the bus verifying all students have evacuated
- Grab first aid kit, manifest and join students
- If cell phone present contact division on status of incident

**Split Door Evacuation**

- Follow procedures from front and rear door evacuations
- Driver will position themselves at the mid-way point of the bus
- Direct students in the front half to exit through the front service door
- Direct the students in the back half to exit through the rear door
- If cell phone is present contact division on status of incident

The split door evacuation is to be used when the driver determines that the bus needs to be evacuated quickly due to the bus stopped on a railway crossing or other immediate danger to students.