Senior 1

Cluster 4: Exploring the Universe

Overview

This cluster leads students through an exploration of the universe, beginning with observational astronomy and ending with a critical look at issues surrounding space science and technology. Students

- observe and locate visible celestial objects. This knowledge provides them with an appreciation for the relevance of astronomy to various peoples.
- develop an understanding of the origin, evolution, and organization of the components of the universe.
- research and study Canada's involvement in international space exploration and evaluate the impact of space science and technologies in terms of their benefits and risks to the human race.

PRESCRIBED LEARNING OUTCOMES
<i>Students will...</i>
<p>S1-4-01 Use a coordinate system to locate visible celestial objects, and construct an astrolabe to determine the position of these objects.</p> <p>Include: altitude, azimuth.</p> <p>GLO: C2, C3, D6</p>
Skills and Attitudes Outcomes
<p>S1-0-1b. Select and justify various methods for finding the answers to specific questions. (Math: S1: A-1) GLO: C2</p> <p>S1-0-3b. Identify probable mathematical relationships between variables. GLO: C2</p> <p>S1-0-4e. Work cooperatively with group members to carry out a plan, and troubleshoot problems as they arise. (ELA: S1: 3.1.3, 5.2.2) GLO: C2, C4, C7</p> <p>S1-0-4f. Assume the responsibilities of various roles within a group and evaluate which roles are most appropriate for given tasks. (ELA: S1: 5.2.2) GLO: C2, C4, C7</p> <p>S1-0-5a. Select and use appropriate methods and tools for collecting data or information. GLO: C2; TFS: 1.3.1</p> <p>S1-0-5b. Estimate and measure accurately using Système International (SI) and other standard units. Include: SI conversions. GLO: C2</p> <p>S1-0-5c. Record, organize, and display data using an appropriate format. Include: labelled diagrams, graphs, multimedia (ELA: S1: 4.1.1, 4.1.2) GLO: C2, C5; TFS: 1.3.1, 3.2.2</p> <p>S1-0-6a. Reflect on prior knowledge and experiences to develop new understanding. (ELA: S1: 4.2.1) GLO: C2, C3, C4</p> <p>S1-0-6b. Identify and suggest explanations for discrepancies in data. <i>Examples: sources of error...</i> (ELA: S1: 3.3.3) GLO: C2</p> <p>S1-0-7a. Draw a conclusion that explains the results of an investigation. Include: cause and effect relationships, alternative explanations, supporting or rejecting the hypothesis or prediction. (ELA: S1: 3.3.4) GLO: C2, C5, C8</p>

SUGGESTIONS FOR INSTRUCTION

(2 HOURS)

➤ **Entry-Level Knowledge**

In Grade 6, students identified technological tools and devices that were designed specifically or indirectly for celestial observations and the exploration of space.

➤ **Notes for Instruction**

Check for prior knowledge using activities from the *Senior Years Science Teachers' Handbook (SYSTH)*, pages 9.6, 9.24, 9.25.

Instill in students a curiosity about space by allowing them to *directly* observe the sky. Encourage students to look at the sky both during the school day and at night to learn to recognize several space objects and their patterns of movement. Obviously, the Sun and Moon are easily recognized and would be the best objects to start with, but students should also learn how to find key stars such as Polaris and some of the major planets. Students will design an instrument to make altitude and azimuth measurements in an angular coordinate system that can be used by a local observer to locate astronomical objects in the sky. Students will develop an understanding of how this coordinate system works by using an instrument designed and constructed for the purpose of accurately determining the positions of easily recognizable celestial objects.

➤ **Student Learning Activities**

Laboratory Activity S1-0-1b, 3b, 4e, 4b, 5a, 5c, 6a, 6b, 7a

Astrolabe Construction and Outdoor Observation: Students or pairs of students construct astrolabes to estimate the angles of elevation of objects above the horizon. Additionally, they will use a compass to determine the azimuth correctly. For example, students can determine the altitude and azimuth of the Moon when it is visible during class time, noting the time of day that the observations were made.

(See Appendix 4.1 for a complete outline of materials, procedures, and construction hints.)

Students gain practice and precision with the astrolabe during daytime hours by locating objects in their immediate vicinity, such as treetops, buildings, etc. Students then attempt to determine the altitudes and azimuths of objects in the sky. It is recommended that students sight the Moon first because of its size and daytime visibility. (See Appendix 4.2)

(continued)

SUGGESTIONS FOR ASSESSMENT

SUGGESTED LEARNING RESOURCES

Rubrics/Checklists

The following rubrics are provided for Appendices 4.1 and 4.2; however, these are intended to serve only as a guide. Rubrics are most effective when designed and created collectively by discussion and consensus PRIOR to the class activity.

Astrolabe:

- Some descriptors are purposely very general to encourage students and teachers to insert their own.
- Emphasize accuracy, design, construction, etc., depending on the skills of the students (e.g., measurement or sighting accuracy).

Rubric for Astrolabe Construction

Performance Level	Criteria
5	Astrolabe can be used to determine the elevation of a viewed object with a high degree of precision and accuracy. It has been well constructed.
4	Astrolabe can be used to determine the elevation of a viewed object but not accurately. It has been well constructed.
3	Astrolabe can be used to determine the elevation of a viewed object but not accurately. It has not been well constructed.
2	Astrolabe does not measure altitude but has been carefully constructed.
1	Astrolabe does not measure altitude and is poorly constructed with little effort and care taken.

Caution: Solar Observations

Students need a reminder that direct observation of the Sun is dangerous, even with a filter apparatus. Solar images should always be projected onto a screen if using optical aids. Even under obscured conditions, solar infrared (IR) can cause retinal damage to the eye when observing directly.

(continued)

Science 9

Activity 13.5: Measuring Angles in the Sky, pp. 408–09

BLM 13.5a: “Properties of the Planets in the Solar System”

BLM 13.5b: Make Your Own Astrolabe

Sciencepower 9

Activity 13.2: The Celestial Movie, pp. 432–33

BLM 13-1: Quiz: “What Can You See with the Unaided Eye?”, p. 434

BLM 13-4: Height of Polaris in the Sky

BLM 13-5 Extension Activity: “Making a Star Map”

Appendices

4.1 Student Learning Activity
Astrolabe Construction

4.2 Student Learning Activity
Locating Celestial Objects Using a System of Coordinates

SYSTH

9.6, 9.24, 9.25 Tapping into Prior Knowledge

PRESCRIBED LEARNING OUTCOMES

Students will...

(continued)
S1-4-01 Use a coordinate system to locate visible celestial objects, and construct an astrolabe to determine the position of these objects.

Include: altitude, azimuth.

GLO: C2, C3, D6

SUGGESTIONS FOR INSTRUCTION

(2 HOURS)

➤ **Student Learning Activities (continued)**

A diagram displaying the use of the student astrolabe to determine angle of elevation appears below. Model the use of an astrolabe with a celestial object like the Moon.

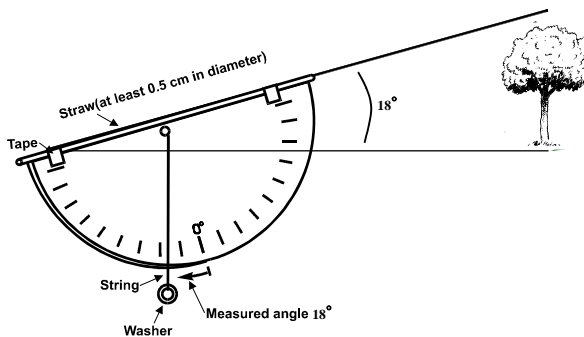

As a first approximation for measuring angles on the sky, encourage students to use a “hand-angle technique.” The diagrams presented below demonstrate how simple hand positions can be used to estimate angle measures on the sky.



When your hand is stretched out, your small finger will measure approximately 1° of space.

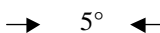

Three fingers as shown at left will measure approximately 5° when your hand is outstretched.

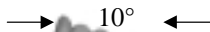

A fist as shown at left will measure approximately 10° when your hand is outstretched.



The index finger to the small finger at left will measure approximately 15° when your hand is outstretched.



Two fists will measure approximately 20° when your hand is outstretched.



The thumb to the small finger will measure approximately 25° when your hand is outstretched.

SUGGESTIONS FOR ASSESSMENT

SUGGESTED LEARNING RESOURCES

Rubric for Outdoor Observation

Performance Level	Criteria
5	Student determines, with a high degree of precision and accuracy, the altitude and azimuth of at least four celestial objects visible in the night sky.
4	Student determines, with some accuracy, the altitude and azimuth of at least three celestial objects visible in the night sky.
3	Student determines, with some accuracy, the altitude and azimuth of at least two celestial objects visible in the night sky.
2	Student determines, with little accuracy, the altitude and azimuth of at least one celestial object visible in the night sky.
1	Student is not able to locate and measure any celestial objects visible in the night sky.

PRESCRIBED LEARNING OUTCOMES
<i>Students will...</i>
<p>S1-4-02 Observe the motion of visible celestial objects and organize collected data.</p> <p><i>Examples: graph sunrise and sunset data, track the position of the Moon and planets over time, maintain a log of changes in the night sky...</i></p> <p>GLO: C2, C5, C6, D6</p>
Skills and Attitudes Outcomes
<p>S1-0-1b. Select and justify various methods for finding the answers to specific questions. (Math: S1: A-1) GLO: C2</p> <p>S1-0-3b. Identify probable mathematical relationships between variables. <i>Examples: relationship between current and resistance...</i> GLO: C2</p> <p>S1-0-4e. Work cooperatively with group members to carry out a plan, and troubleshoot problems as they arise. (ELA: S1: 3.1.3, 5.2.2) GLO: C2, C4, C7</p> <p>S1-0-4f. Assume the responsibilities of various roles within a group and evaluate which roles are most appropriate for given tasks. (ELA: S1: 5.2.2) GLO: C2, C4, C7</p> <p>S1-0-5a. Select and use appropriate methods and tools for collecting data or information. GLO: C2; TFS: 1.3.1</p> <p>S1-0-5b. Estimate and measure accurately using Système International (SI) and other standard units. Include: SI conversions. GLO: C2</p> <p>S1-0-5c. Record, organize, and display data using an appropriate format. Include: labelled diagrams, graphs, multimedia (ELA: S1: 4.1.1, 4.1.2) GLO: C2, C5; TFS: 1.3.1, 3.2.2</p> <p>S1-0-6a. Reflect on prior knowledge and experiences to develop new understanding. (ELA: S1: 4.2.1) GLO: C2, C3, C4</p> <p>S1-0-6b. Identify and suggest explanations for discrepancies in data. <i>Examples: sources of error...</i> (ELA: S1: 3.3.3) GLO: C2</p> <p>S1-0-7a. Draw a conclusion that explains the results of an investigation. Include: cause and effect relationships, alternative explanations, supporting or rejecting the hypothesis or prediction. (ELA: S1: 3.3.4) GLO: C2, C5, C8</p>

SUGGESTIONS FOR INSTRUCTION

(4 HOURS)

➤ **Entry-Level Knowledge**

In Grade 6, students made rough observations of planets and constellations to identify movement across the night sky. However, they did not measure the position of the objects over time.

➤ **Notes for Instruction**

Check for prior knowledge using activities from *SYSTH*, pages 9.6, 9.24, 9.25.

This learning outcome is best accomplished with activities that relate to the recording and analysis of observations of the suggested celestial objects. Emphasize the careful observations and recording of data over time, and the plotting of data in a *graphical mode*. Hopefully, students will then take their observations and link them to the more abstract graphical representations to form a coherent explanation of the motions of celestial objects.

➤ **Student Learning Activities**

Laboratory Activity

Observation of the Sun's Position: Students will use indirect techniques for observing the Sun in order to collect and record data about its position in the sky. For instance, in order to determine its height above the horizon (altitude), a metre stick can be used to cast a shadow. Its length is then measured, and a simple trigonometric relation can compute the angle.

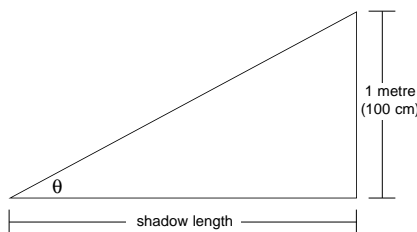

$$\text{Tangent of altitude angle} = \frac{1 \text{ metre}}{\text{shadow length (m)}}, \text{ or}$$

$$\tan \theta = \frac{1}{\text{shadow length (m)}}$$

(continued)

SUGGESTIONS FOR ASSESSMENT

SUGGESTED LEARNING RESOURCES

Rubrics/Checklists

Assess students' logbooks, data tables, and graphs using the Checklist of Graphing Skills. (See *SYSTH*, page 2.16)

Teacher Background

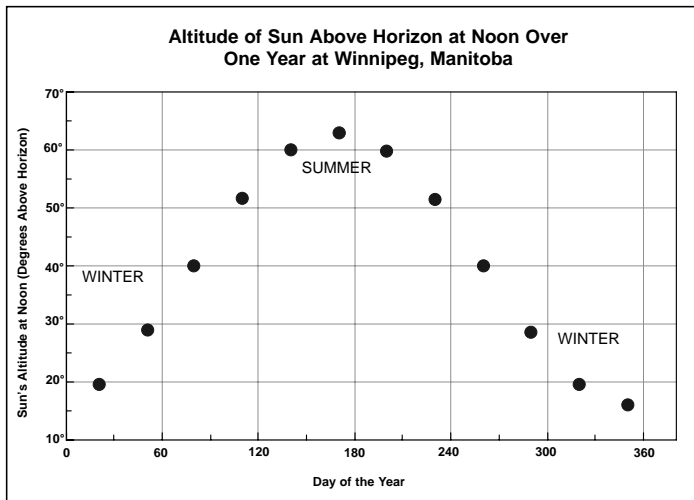

Sample Solar Observation Graph

The data required to produce this plot could come from the students' own astrolabe measurements (with all due safety precautions for the eyes) over the course of the year's lunch hours. The astrolabe could be held close to the ground, then oriented such that the shadow of the straw cannot be seen (alignment with the Sun). Then, the altitude of the Sun could be read carefully, and recorded in a logbook. For the interested teacher and students, it is instructive to determine the amplitude of this "wave" that you see here — it works out to exactly 23.5 degrees, which is the current axial tilt of our home planet.

Science 9

Activity 13.8: Observing the Night Sky, pp. 414–15,

Activity 13.7a: Blackline Master Seasonal Star Map

Investigation 13.2: Sunrise and Sunset (page 403), and Blackline Master 13.2: Sunrise and Sunset Times from 45 Degrees Latitude (Toronto)

Activity 13.4: Recognizing Constellations, pp. 406–07

Activity 13.7: A Seasonal Star Map, pp. 412–13

Sciencepower 9

BLM 13-5: Making a Star Map

BLM 13-6: Observing Motions of the Planets

BLM 15-1: Pattern of Stars in the Sky

BLM 15-13: Finding the Andromeda Galaxy with Binoculars

SYSTH

2.16 Checklist of Graphing Skills

9.6, 9.24, 9.25 Tapping into Prior Knowledge

Other Resources

"Canadian Skies" poster available free of charge from margaret.kennedy@nrc.ca

(continued)

PRESCRIBED LEARNING OUTCOMES
<i>Students will...</i>
(continued)
S1-4-02 Observe the motion of visible celestial objects and organize collected data. <i>Examples: graph sunrise and sunset data, track the position of the Moon and planets over time, maintain a log of changes in the night sky...</i>
GLO: C2, C5, C6, D6

SUGGESTIONS FOR INSTRUCTION

(4 HOURS)

➤ **Student Learning Activities (continued)**

Students may also estimate using the “hand-angle” technique if proper safety precautions for the eyes are in place. Collected data can then be plotted onto a graph as outlined in Appendix 4.3.

Observation of the Moon: Students directly observe the Moon at the same time over several days or evenings. Students estimate its altitude and azimuth, record their observations (e.g., students could chart the altitude and azimuth of the Moon at the same time [say, 8 p.m. each day] over a 14-day period from New Moon to Full Moon), and then plot graphs of

- Altitude vs. Day of Observation (see sample graph at right)
- Azimuth vs. Day of Observation
- Altitude vs. Azimuth (over the course of weeks or months)

Students then analyze their results, and predict the location of the Moon at a particular time, or whether it will be visible at all. Similar activities could be done with the planets Venus, Mars, Jupiter, and Saturn over a period of weeks or months. The number of celestial objects viewed and the degree of recording, plotting, and analysis would be determined by available time, interest, and the skill level of the class.

Students’ Extension Activity: Use a spreadsheet and a plotting program to illustrate and analyze their data.

SUGGESTIONS FOR ASSESSMENT

SUGGESTED LEARNING RESOURCES

Teacher Background

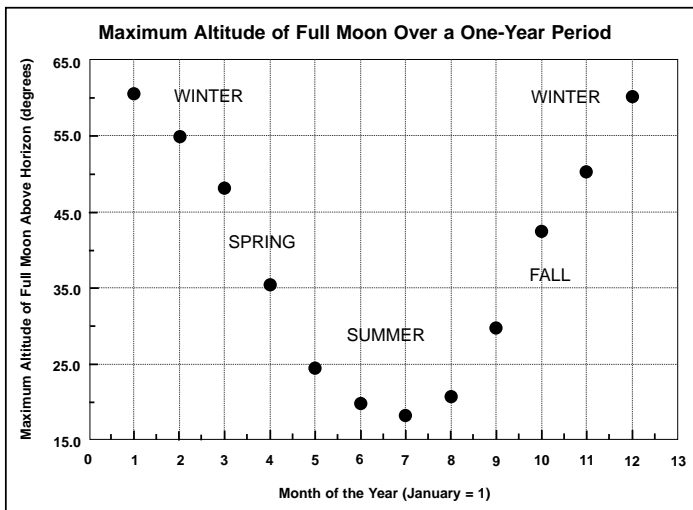

Sample Lunar Observation Graph

If one were to record data on the maximum height of the Moon in the sky on a series of evenings over the course of a year, a rather interesting result would emerge. The Moon is higher in the sky during the winter in the Northern Hemisphere, and is significantly lower in the sky during the summer months. This is because of the superposition of two opposing geometries: the inclination of the Earth’s axis with respect to its orbit around the Sun, and the inclination of the Moon’s orbital path around the Earth with respect to the Equator. Historically, and for ancient cultures, it was fortuitous to have the Moon dominating the night sky at a time when the hours of daylight were shortened.

Ask students, “Could this unique situation have an influence on the ocean tides?” This may explain why the Swampy Cree of northern Manitoba refer to the moon as “tipiskaw pissim” or “night Sun,” rather than giving it a separate planetary significance.

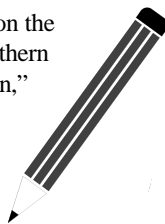

Appendices

- 4.3 Student Learning Activity
Observing and Charting the
Motions of Celestial Objects
- 4.4 Student Learning Activity
Motion of the Sun as Seen from
Earth

Multimedia

Starry Night Backyard. planetarium software

PRESCRIBED LEARNING OUTCOMES
<i>Students will...</i>
<p>S1-4-03 Investigate how various cultures used knowledge of the position and motion of visible celestial objects for navigation.</p> <p><i>Example: Aboriginal ceremonies linked to seasonal star positions...</i></p> <p>GLO: A4, B1, B2, D6</p>
Skills and Attitudes Outcomes
<p>S1-0-1b. Select and justify various methods for finding the answers to specific questions. (Math: S1: A-1) GLO: C2</p> <p>S1-0-3b. Identify probable mathematical relationships between variables. <i>Examples: relationship between current and resistance...</i> GLO: C2</p> <p>S1-0-5a. Select and use appropriate methods and tools for collecting data or information. GLO: C2; TFS: 1.3.1</p> <p>S1-0-5b. Estimate and measure accurately using Système International (SI) and other standard units. Include: SI conversions. GLO: C2</p> <p>S1-0-5c. Record, organize, and display data using an appropriate format. Include: labelled diagrams, graphs, multimedia (ELA: S1: 4.1.1, 4.1.2) GLO: C2, C5; TFS: 1.3.1, 3.2.2</p> <p>S1-0-6a. Reflect on prior knowledge and experiences to develop new understanding. (ELA: S1: 4.2.1) GLO: C2, C3, C4</p> <p>S1-0-6b. Identify and suggest explanations for discrepancies in data. <i>Examples: sources of error...</i> (ELA: S1: 3.3.3) GLO: C2</p> <p>S1-0-7a. Draw a conclusion that explains the results of an investigation. Include: cause and effect relationships, alternative explanations, supporting or rejecting the hypothesis or prediction. (ELA: S1: 3.3.4) GLO: C2, C5, C8</p>

SUGGESTIONS FOR INSTRUCTION

(2 HOURS)

➤ **Entry-Level Knowledge**

In Grade 6, students described how people from various cultures, past and present, applied astronomy to their daily lives.

➤ **Notes for Instruction**

Check for prior knowledge using activities from *SYSTH*, pages 9.6, 9.24, 9.25.

It is important for students to recognize that “navigation” is not exclusive to travel at sea. Aboriginal communities of the interior plains utilized the seasonal positions of stars and constellations in a ceremonial way. They had a sophisticated knowledge of the link between seasonal events, such as the solstices and equinoxes, and the star positions that heralded them.

Due to precession (a gyroscopic effect of the Moon’s gravitational attraction to the Earth’s tidal bulge), the Earth’s axis traces out a circle — a cycle that requires about 26,000 years. One result of this is that the North Pole star (“the star that always stands in one place,” according to the Lakota people) changes to whatever stars align with the Earth’s axis at that time. Right now, Polaris is about 0.75° away from true north; in 3,000 B.C., it was Thuban (a star in Draco), and in 14,000 A.D., it will be Vega in the constellation Lyra. For many centuries, no distinct North Pole star could be used to determine the four directions. The timing of certain sun dances has been steadily delayed as precession alters the navigation points in the sky, and knowledgeable elders know of these changes.

➤ **Student Learning Activities**

Student Research/Reports

Students or pairs of students investigate a culture that used visible celestial objects for navigation (e.g., Greek, Roman, Polynesian, Nordic, Inuit, Aboriginal people of North America, Chinese, etc).

The investigation should include more than one source of information, and more than one type of source (books, Internet, CD-ROMs, encyclopedias, etc.). The written report that the students produce should include a list of their sources, or bibliography (ELA: S1:3.3.2). If time allows, the students could also do a class presentation.

SUGGESTIONS FOR ASSESSMENT

SUGGESTED LEARNING RESOURCES

Research Report/Presentation

Students or student groups research a particular culture that made use of astronomical objects for navigation. Reports can be presented as

- written reports
- oral presentations
- posters
- pamphlets
- information technology presentations
- multimedia presentations
- storytelling or dramatic presentation

Textbooks, library reference materials, Internet sites, and other print and electronic media can be used for research and presentations.

Teacher, peer, or self assessment can be used.

Science 9

Star Constellations, pp. 400–01

Case Study 13.6: Different Views of the Sky, pp. 410–11

BLM 13.6 Floor Plan of Stonehenge

Sciencepower 9

Teacher’s Resource Binder: Assessment and Evaluation Handbook

Assessment Checklist 10:

General Presentation Checklist

Assessment Checklist 20:

Oral Presentation

Assessment Checklist 26:

Writing in Science

What Our Ancestors Saw, pp. 430–31

BLM 13-8: Movement of the Circumpolar Stars

Appendices

5.2 Rubric for the Assessment of Class Presentations

5.3 Rubric for the Assessment of a Research Project

SYSTH

9.6, 9.24, 9.25 Tapping into Prior Knowledge

PRESCRIBED LEARNING OUTCOMES

SUGGESTIONS FOR INSTRUCTION

Students will...

(continued)

S1-4-03 Investigate how various cultures used knowledge of the position and motion of visible celestial objects for navigation.

Example: Aboriginal ceremonies linked to seasonal star positions...

GLO: A4, B1, B2, D6

SUGGESTIONS FOR ASSESSMENT

SUGGESTED LEARNING RESOURCES

Teacher Background

Early Navigation

The need to travel from one place to another became important as ancient cultures gathered into larger groups and settled in towns. The need for food was satisfied when hunters left their settlements, hunted their food, and easily returned to their homes because they remained in familiar territory. As the need for trade with other cultures became important, travel then took people much longer distances away from their home. Overland trade was still relatively easy since the travellers used well-established routes that were easily followed.

Societies that located on the edge of water naturally used the sea as their method of transportation. Initially, boats would travel within sight of shore so that they could fish and carry on commerce with nearby groups. Familiar landmarks, such as rocks or shoals, could have been used to mark locations and routes back and forth from home base. The sea left no trail as land travel did; as a result, the landmarks would be memorized and passed on from one generation to the next. Using sighted landmarks could be dangerous for sailors if the sightings were lost or obscured by fog or sudden storms. Even with these restrictions placed upon them, sailors were able to establish trade routes to distant ports.

Some nations that were able to travel long distances include the Phoenicians and Egyptians. In addition to trade, the nations that were able to navigate successfully over water were able to conquer other countries, increasing their power and wealth.

Seafarers began to use celestial objects to help navigate their ships. They noticed different shapes of star groupings, called constellations, which they could memorize and use as indicators from which they could determine the direction they were heading. Gradually, stars and the Sun became the “landmarks” used for navigation.

Constellations, which are groups of stars, were recognized early in the history of civilization. The Phoenicians, for example, identified and named most of the constellations we know today, and they did it 4,000 years ago! The constellations were given different names by different nations, but they were usually named after gods or familiar animals. The constellations can be used as signposts, as they direct one’s view to particular parts of the sky and help identify individual stars.

The change from having to remain within land view to being able to travel across oceans had a profound impact on travel, trade, and the exchange of ideas. Suddenly, people could travel huge distances with little effort. Trade was taking place between Egypt and the island of Crete, a distance of 500 kilometres, on a regular basis around 2500 BCE. By 600 BCE, Phoenicians were importing tin from Cornwall, England. The Vikings had established routes to England, Greenland, and even North America by the 10th century. Polynesian seamen, considered the best in the world, were able to emigrate all the way from the Marquesas islands to Hawaii, a distance of 3700 kilometres, by 400 AD.



PRESCRIBED LEARNING OUTCOMES
<i>Students will...</i>
<p>S1-4-04 Compare and contrast historical perspectives on the relationship between Earth and space. Include: geocentric model, heliocentric model. GLO: A2, A4, B2, E2</p>
Skills and Attitudes Outcomes
<p>S1-0-4e. Work cooperatively with group members to carry out a plan, and troubleshoot problems as they arise. (ELA: S1: 3.1.3, 5.2.2) GLO: C2, C4, C7</p> <p>S1-0-4f. Assume the responsibilities of various roles within a group and evaluate which roles are most appropriate for given tasks. (ELA: S1: 5.2.2) GLO: C2, C4, C7</p> <p>S1-0-7a. Draw a conclusion that explains the results of an investigation. Include: cause and effect relationships, alternative explanations, supporting or rejecting the hypothesis or prediction. (ELA: S1: 3.3.4) GLO: C2, C5, C8</p> <p>S1-0-8c. Describe examples of how scientific knowledge has evolved in light of new evidence, and the role of technology in this evolution. GLO: A2, A5</p> <p>S1-0-8e. Discuss how peoples of various cultures have contributed to the development of science and technology. GLO: A4, A5</p>

SUGGESTIONS FOR INSTRUCTION

(3 HOURS)

➤ **Entry-Level Knowledge**

In Grade 6, students were introduced to descriptive models of how the Earth’s position was explained by earlier pre-scientific and scientific cultures. Students gained a perspective of how these early models were questioned and, as a consequence, evolved over time to become the Sun-centred model of today. The terms geocentric (Earth-centred) and heliocentric (Sun-centred) will now replace the less sophisticated terms used in the Grade 6 Space cluster.

In addition, students should now have their knowledge base extended to investigations of non-western views of the Earth in the cosmos. Particular attention should be paid to North American Aboriginal, Asian, and Mesopotamian cosmologies.

➤ **Notes for Instruction**

Check for prior knowledge using activities from *SYSTH*, pages 9.6, 9.24, 9.25.

➤ **Student Learning Activities**

Student Research/Reports S1-0-4e, 4f, 7a, 8c, 8e

The Great Dialogue: Students divide themselves into two opposing world views — the “Ptolemaics” or “Aristotelians,” and the “Copernicans.” Each group gathers evidence to support their respective views (e.g., each group accounts for the rising and setting of the Sun, the motions of the Moon and planets over successive months, the seasons, retrograde motion of Mars, and other celestial phenomena). The two groups then debate the strengths and shortcomings of each model. (See *SYSTH*, pages 4.19, 4.20, and 4.21)

The Trial of Galileo Revisited: Students involve themselves in their own “dialogue concerning two world systems,” as Galileo so aptly put it four centuries ago, by recreating the trial of Galileo under the Holy Office of the Inquisition. Students play the roles of the central characters, and consider the sociological, religious, and cosmological struggles between vested interests of the times to better understand the key concepts related to the Earth and its position relative to other objects in the solar system.

SUGGESTIONS FOR ASSESSMENT

SUGGESTED LEARNING RESOURCES

Rubrics/Checklists

Rubrics and checklists can be used for self, peer, or teacher assessment. See the Suggested Learning Resources column for specific examples.

Written Quiz/Test**Students**

- complete a Compare and Contrast or Concept Relationship frame comparing the Ptolemaic and Copernican models of the cosmos in terms of their advantages and disadvantages for explaining the motions of planets. (See *SYSTH*, page 10.21)
- describe situations in which one of the two competing models is more advantageous than the other in explaining certain phenomena related to planetary motions.
- prepare a Concept Map illustrating the relationship between the geocentric and heliocentric models of the solar system.

Teacher Background

The transition from a geocentric to the acceptance of a heliocentric model of the solar system is generally accepted as an example of a scientific revolution in astronomical thought, which led to a major shift in scientific world views. It is also an example of how scientific knowledge has evolved in light of new evidence, and the role of technology (telescope) in this evolution. Students should have the opportunity to experience as many facets of this revolution as possible, from the individuals involved, to their vested interests, politics, religious beliefs, and observations.

The geocentric model is often referred to as a “Ptolemaic model” in honour of the Greek philosopher, astronomer, and geographer Claudius Ptolemaeus (ca. 85–165 AD). Other geocentric schemes are attributed to Aristotle (384–322 BCE) and Tycho Brahe (d. 1601). All of these models attached themselves to a belief in “crystalline spheres” within which heavenly bodies were embedded. The elegance, functionality, and problem-solving power of the geocentric model allowed it to direct the science of astronomy for over 1500 years. Though eventually abandoned, it is important to recognize that virtually all observations from Earth are more readily acceptable to students operating within a pre-Renaissance view of the cosmos.

The heliocentric model is referred to as the Copernican model since it was first popularized by Nicolaus Copernicus (1473–1543), a Polish astronomer who is considered to be the founder of modern astronomy. It is noteworthy that the heliocentric model dates from early Greek astronomy with Aristarchus of Samos.

Brief Biographies of Selected Historical Figures:

Aristotle: *Sciencepower 9*, p. 435
Science 9, pp. 82, 144

Ptolemy: *Sciencepower 9*, p. 436

Galileo: *Sciencepower 9*, p. 437
Science 9, pp. 430, 438–39

Copernicus: *Sciencepower 9*, p. 436
Science 9, p. 438

Sciencepower 9

13.3 Modeling Celestial Motion,
pp. 435–42

Activity: Explaining Retrograde
Motion in the Earth-
Centred Model, p. 437

Activity: Viewing Jupiter’s Moons,
p. 438

Pause and Reflect, p. 439

Investigation 13-B:
Explaining Retrograde Motion in the
Sun-Centred Model, pp. 440–41

BLM 13-9 Motion of the Sun in the
Earth-Centred Model

BLM 13-10 Seasonal Height of the
Sun in the Earth-Centred
Model

BLM 13-11 Angle of the Sun in the
Sun-Centred Model

BLM 13-13 Path of the Earth Around
the Sun

BLM 13-14 The Moon’s Motion

SYSTH

4.19–4.21 Debate Guidelines

9.6, 9.24–25 Tapping into Prior
Knowledge

10.24 Building a Scientific
Vocabulary

PRESCRIBED LEARNING OUTCOMES
<i>Students will...</i>
<p>S1-4-05 Explain the apparent motion of the Sun, stars, planets, and the Moon as seen from Earth.</p> <p>Include: daily rising and setting, seasonal constellations, retrograde motion.</p> <p>GLO: D4, D6, E2</p>
Skills and Attitudes Outcomes
<p>S1-0-1a. Propose questions that could be tested experimentally. (ELA: S1: 3.1.2) GLO: C2</p> <p>S1-0-1b. Select and justify various methods for finding the answers to specific questions. (Math: S1: A-1) GLO: C2</p> <p>S1-0-2a. Select and integrate information obtained from a variety of sources. Include: print, electronic, specialists, other resource people. (ELA: S1: 3.1.4, 3.2.3; Math: S1-B-1, 2; TFS 2.2.1) GLO: C2, C4, C6; TFS: 1.3.2, 4.3.4</p> <p>S1-0-2c. Summarize and record information in a variety of forms. Include: paraphrasing, quoting relevant facts and opinions, proper referencing of sources. (ELA: S1: 3.3.2) GLO: C2, C4, C6; TFS: 2.3.1, 4.3.4</p> <p>S1-0-3c. Plan an investigation to answer a specific scientific question. Include: materials, variables, controls, methods, safety considerations. GLO: C1, C2</p> <p>S1-0-5a. Select and use appropriate methods and tools for collecting data or information. GLO: C2; TFS: 1.3.1</p> <p>S1-0-5c. Record, organize, and display data using an appropriate format. Include: labelled diagrams, graphs, multimedia (ELA: S1: 4.1.1, 4.1.2) GLO: C2, C5; TFS: 1.3.1, 3.2.2</p> <p>S1-0-6a. Reflect on prior knowledge and experiences to develop new understanding. (ELA: S1: 4.2.1) GLO: C2, C3, C4</p> <p>S1-0-6b. Identify and suggest explanations for discrepancies in data. <i>Examples: sources of error...</i> (ELA: S1: 3.3.3) GLO: C2</p> <p>S1-0-7a. Draw a conclusion that explains the results of an investigation. Include: cause and effect relationships, alternative explanations, supporting or rejecting the hypothesis or prediction. (ELA: S1: 3.3.4) GLO: C2, C5, C8</p> <p>S1-0-8c. Describe examples of how scientific knowledge has evolved in light of new evidence, and the role of technology in this evolution. GLO: A2, A5</p>

SUGGESTIONS FOR INSTRUCTION
(4 HOURS)

➤ **Entry-Level Knowledge**

In Grade 6, students used models and/or simulations to explain the interrelationships among the Earth, Moon, and Sun with respect to phenomena that included solar and lunar eclipses, tides, the seasons, day and night cycles, and lunar phases.

➤ **Notes for Instruction**

Students examine more subtle motions — particularly *retrograde motions* that are observed in the planets more distant from the Sun than Earth. Additionally, students should also develop a stronger conceptual understanding of what underlies these “apparent” motions, and be prepared to observe these motions over time outdoors and with planetarium software.

Activate students’ prior knowledge/experience by asking the following questions: Have you ever noticed that a Full Moon in winter is higher in the sky than one in mid-summer? Can this be easily observed or explained?

➤ **Student Learning Activities**

Visual Displays S1-0-1b, 6a

Students create a “flip-motion” book that illustrates *retrograde motion*, and contains approximately 25 pages of stiff paper, securely stapled at one end with small planet diagrams on each page that appear to move like an animated filmstrip when the pages are flipped.

Student Research/Reports S1-0-2a, 5a, 5c, 6a, 6b, 7a

Observations of the motions of planets like Mars and Jupiter over a period of time ranging from days to weeks can illustrate retrograde motion if their positions with respect to the Earth are favourable for this. Students consult astronomy periodicals for precise locations of Mars and Jupiter. By collecting and plotting position data on a simplified seasonal star chart, students observe retrograde motion against the background of “fixed stars.” Students can also graph data manually (or with software) to see the motion more clearly. Planetarium-type software can be used to visually reinforce this phenomenon.

(continued)

SUGGESTIONS FOR ASSESSMENT

SUGGESTED LEARNING RESOURCES

By observing and plotting the location of the Moon over a series of days, weeks, or perhaps months, students explain the Moon's motion. Teachers can refer to the graphs prepared by students earlier (See S1-4-02) or use the sample graphs in Appendix 4.7. (See below for teacher reference graph)

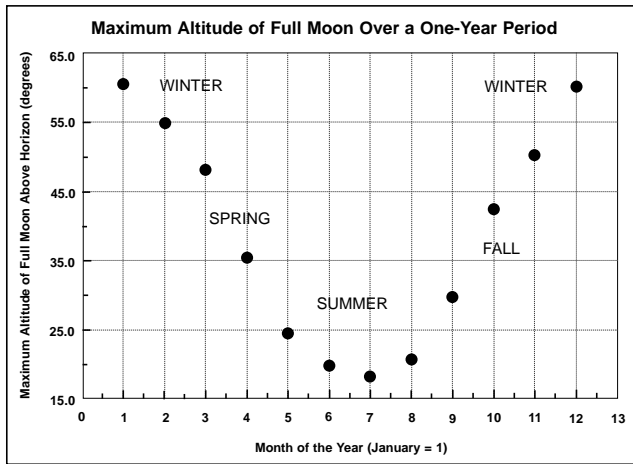

Students also account for the changes in motion of the Sun and answer the following questions:

- On which day(s) does the Sun rise exactly in the east and set exactly in the west? (Vernal and Autumnal Equinoxes)
- Do we attach any significance to these dates? (beginning of spring and fall).

The position of sunset over the year is not always due west. In fact, the Sun sets in the west only twice per year, and these dates can be seen where the azimuth is 270°.

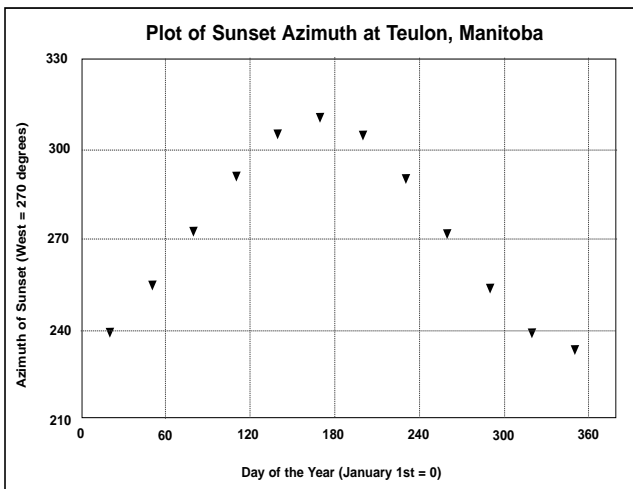

(continued)

Science 9

Activity 13.3 The Effects of Planetary Motion, pp. 404–05

Activity 13.4 Recognizing Constellations, pp. 406–07

Activity 13.7 A Seasonal Star Map, pp. 412–13

Sciencepower 9

BLM 13-3 Path of the Sun and Its Height above the Horizon at Noon

BLM 13-5 Making a Star Map

BLM 13-6 Observing Motions of the Planets

BLM 13-7 Positions of Mars

BLM 13-12 Hours of Daylight in Northern Canada in the Sun-Centred Model

BLM 13-13 Path of Earth Around the Sun

BLM 13-14 The Moon's Motion

BLM 13-15 Motions of Mars and Jupiter

Appendices

4.5 Student Learning Activity Monitoring the Retrograde Motion of the Planet Mars

4.7 Teacher Support Material Sample Plots of Astronomical Data for Teacher Reference, and Databases for Objects

(continued)

PRESCRIBED LEARNING OUTCOMES

Students will...

(continued)

S1-4-05 Explain the apparent motion of the Sun, stars, planets, and the Moon as seen from Earth.

Include: daily rising and setting, seasonal constellations, retrograde motion.

GLO: D4, D6, E2

SUGGESTIONS FOR INSTRUCTION

(4 HOURS)

➤ **Student Learning Activities (continued)**

Visual Displays S1-0-1a, 1b, 2c, 3c, 8c

Students use an analysis of retrograde motion as the basis for developing actual working models of how both the geocentric and heliocentric systems accounted for this phenomenon (e.g., dynamic geometry software could be used in modelling these motions).

Journal Writing

Consider the following analogy for retrograde motion:

Runners are in a race around an oval track. Each runner represents a planet, with some running on the inside tracks and others on the outside tracks. If all of the runners (planets) were to have the same starting positions, explain why the inner track runners would observe retrograde motion by watching their competitors in the outside lanes. Is this a good analogy for the planets in the solar system?

SUGGESTIONS FOR ASSESSMENT

SUGGESTED LEARNING RESOURCES

Often, it is the planet Mars' retrograde motions that are observed, tracked, and plotted. After students have completed Appendix 4.5 on the retrograde motions of Mars, they can compare their plots to the one represented here.

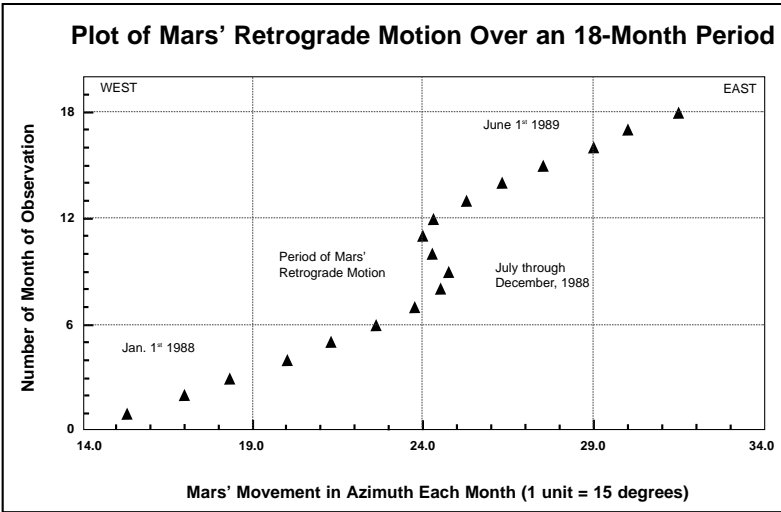

Multimedia

Starry Night: Deluxe Edition or *Skyglobe 4.0 for Windows*, available as shareware at www.maa.mhn.de.

Canadian Skies poster available free of charge from margaret.kennedy@nrc.ca

PRESCRIBED LEARNING OUTCOMES
<i>Students will...</i>
<p>S1-4-06 Differentiate between units of measure used for astronomical distances, and perform simple calculations using these units.</p> <p>Include: astronomical unit, light-year.</p> <p>GLO: C2, D6</p>
Skills and Attitudes Outcomes
<p>S1-0-5a. Select and use appropriate methods and tools for collecting data or information. GLO: C2; TFS: 1.3.1</p> <p>S1-0-5b. Estimate and measure accurately using Système International (SI) and other standard units. Include: SI conversions. GLO: C2</p> <p>S1-0-5c. Record, organize, and display data using an appropriate format. Include: labelled diagrams, graphs, multimedia (ELA: S1: 4.1.1, 4.1.2) GLO: C2, C5; TFS: 1.3.1, 3.2.2</p> <p>S1-0-6b. Identify and suggest explanations for discrepancies in data. <i>Examples: sources of error...</i> (ELA: S1: 3.3.3) GLO: C2</p>

SUGGESTIONS FOR INSTRUCTION

(2 HOURS)

➤ **Notes for Instruction**

Observing and studying the cosmos presents a new set of problems when it comes to students appreciating the *scales* involved with measurement. The distances of even nearby celestial objects are vast — particularly at the scales of interstellar and intergalactic (between galaxies) distances. Help students appreciate the magnitude of the measurements involved, and the need for new units of measure.

Develop students’ understanding that because of the vastness of space, special units are required to measure the distances between celestial objects such as stars. Historically, the distances in our solar system were the first to be estimated, followed by distances outside of our solar system. Once students have been introduced to both units (astronomical units and light-years) the Compare and Contrast frame from *SYSTH* (page 10.24) could be used.

Astronomers have developed convenient units of measure to accommodate and reduce interstellar and intergalactic distances to manageable numbers. In the solar system, for instance, the standard unit of measure is the astronomical unit (A.U.), which is the mean distance between the Sun and the Earth (approximately 1.5×10^8 km). Hence, the distances to the planets can be determined using convenient numbers that are less than 50. For example, the distance from the Sun to Jupiter is about 5.0 A.U.

Distances between the stars (interstellar) are measured using the light-year (l.y.), which is equivalent to the distance travelled by a photon of light in a vacuum (space) in the course of one solar year (365.25 days). At a velocity of 300,000 km/second, a light-year is on the order of 10 trillion kilometres (1.0×10^{13} km). To use an example, the distance from our Sun to its nearest star system (Alpha Centauri) is 4.28 light-years. This is a much more convenient measure than, say, 63,000 astronomical units or its equivalent in kilometres.

SUGGESTIONS FOR ASSESSMENT

SUGGESTED LEARNING RESOURCES

Written Test/Quiz

Students answer questions such as:

- Is the term “light-year” used for interplanetary or interstellar distances?
- What would an “interstudent” distance be, and what would be the most appropriate unit of measure?
- A star is estimated by astronomers to be 570 A.U. from the Sun. Would the equivalent distance in light-years be greater or lesser than 570? Explain.
- A model of planet formation for the Solar System predicts that a planet should be at a distance of 3.0 A.U. from the Sun. What objects are found at this distance from the Sun?

Journals

Students compose at least five questions about measuring distances and space travel and send them to teachers, classmates, or a local astronomer, asking them to assess the quality of their questions and our present ability to answer the questions.

Science 9

Activity 14.3 Using Triangles to Measure Distances, pp. 442–43

Activity 14.4 Distances in Space, pp. 444–45

Activity 14.5 Scaling the Universe, pp. 446–47

Sciencepower 9

BLM 15.1 Measuring Distance in the Cosmos, pp. 488–94

Investigation 15-A:
Using Triangulation to Measure an Unknown Distance, pp. 492–93

BLM 15-2 Finding Earth’s Size

BLM 15-3 Measuring Distance to the Moon

BLM 15-4 Triangulation

BLM 15-5 Astronomical Distance Units

BLM 15-8 Distances in our Galaxy

BLM 15-12 Astronomical Numbers: Scientific Notation

PRESCRIBED LEARNING OUTCOMES
<i>Students will...</i>
<p>S1-4-07 Compare and contrast scientific and cultural perspectives on the origin and evolution of the universe. GLO: A1, A2, A4, D6</p>
Skills and Attitudes Outcomes
<p>S1-0-2a. Select and integrate information obtained from a variety of sources. Include: print, electronic, specialists, other resource people. (ELA: S1: 3.1.4, 3.2.3; Math: S1-B-1, 2; TFS 2.2.1) GLO: C2, C4, C6; TFS: 1.3.2, 4.3.4</p> <p>S1-0-2b. Evaluate the reliability, bias, and usefulness of information. (ELA: S1: 3.2.3, 3.3.3) GLO: C2, C4, C5, C8; TFS: 2.2.2, 4.3.4</p> <p>S1-0-2c. Summarize and record information in a variety of forms. Include: paraphrasing, quoting relevant facts and opinions, proper referencing of sources. (ELA: S1: 3.3.2) GLO: C2, C4, C6; TFS: 2.3.1, 4.3.4</p> <p>S1-0-8c. Describe examples of how scientific knowledge has evolved in light of new evidence, and the role of technology in this evolution. GLO: A2, A5</p> <p>S1-0-8e. Discuss how peoples of various cultures have contributed to the development of science and technology. GLO: A4, A5</p> <p>S1-0-9a. Appreciate and respect that science and technology have evolved from different views held by women and men from a variety of societies and cultural backgrounds. GLO: A4</p>

SUGGESTIONS FOR INSTRUCTION

(1-1/2 HOURS)

➤ **Notes for Instruction**

Science is based on physical evidence and our best understanding or explanation of that evidence. Help students to appreciate how the explanation of physical evidence varies among different cultures.

➤ **Student Learning Activities**

Student Research/Reports S1-0-2a, 2b, 2c

Students or student groups research the beliefs about the origin and evolution of the universe for one of the cultures suggested.

Note: An awareness of cultural perspectives is required. It is not necessary to compare scientific theories to various cultural beliefs.

Research could take the form of receiving and summarizing the main ideas from previously selected research articles and then displaying the report as a poster, flip chart, or multimedia presentation. (See *SYSTH*, page 12.3)

Teacher Background

Two generally accepted scientific theories of the origin of our universe exist: George Lemaître’s “big bang theory” and Sir Fred Hoyle’s “steady-state theory.” Both theories and evidence for them are discussed in the texts. However, the big bang theory seems to have gathered more followers than the steady-state theory. Although these are the two most accepted scientific views on the origin of the universe, many other beliefs exist in different cultures around the world (i.e., Greek, Roman, Polynesian, Nordic, North American Aboriginal, Chinese, etc.).

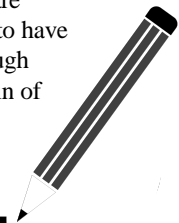

SUGGESTIONS FOR ASSESSMENT

SUGGESTED LEARNING RESOURCES

Written Test/Quiz

Students

- explain the big bang theory, and suggest reasons why it is important for our understanding of the scientific explanation of the origin of the universe.
- use a Compare and Contrast frame to differentiate among pre-science, science, and emerging technologies in terms of their purpose, procedures, and impact on various cultures' understanding of the origin of the cosmos. (See *SYSTH*, page 10.24)
- complete a fact- or issue-based article analysis of a current newspaper or magazine article related to the topic of culturally based views of the universe. (See *SYSTH*, pages 11.30, 11.40–11.41)
- write a newspaper article outlining current research and findings related to the origin of the universe.

Research Report/Presentation S1-0-2a, 2b, 2c

Students or student groups investigate a contribution of a particular culture related to the origin and evolution of the universe. Reports can be presented as

- written reports
- oral presentations
- posters
- pamphlets
- information technology presentations
- cartoon/comic books
- newspaper articles
- Concept Overview or Compare and Contrast frames

Information can be gathered from a variety of sources. Word processing and desktop publishing software can be used for report writing.

Science 9

Activity 15.3: A Model of the Expanding Universe, page 475

Activity 15.4: Evidence of an Expanding Universe, pp. 476–77

Activity 15.5: The Origin of the Universe, pp. 478–79

Sciencepower 9

A number of checklists that will be useful in the assessment of presentation activities:

Checklist 10: General Presentation Checklist

Checklist 20: Oral Presentation

Checklist 21: Poster

Checklist 26: Writing in Science

Activity 15.4: The Formation of the Universe, pp. 506–12

Investigation 15C: Modeling the Expanding Universe (page 505) and BLM 15-1.

SYSTH

3.3 Cooperative Learning and Science

10.15, 10.24 Building a Scientific Vocabulary

11.30, 11.40 Developing Scientific Concepts Using Graphic Displays

12.3 Reading Scientific Information

PRESCRIBED LEARNING OUTCOMES
<i>Students will...</i>
<p>S1-4-08 Differentiate between the major components of the universe.</p> <p>Include: planets, moons, comets and asteroids, nebulae, stars, galaxies, black holes.</p> <p>GLO: D6, E1, E2</p>
Skills and Attitudes Outcomes
<p>S1-0-2a. Select and integrate information obtained from a variety of sources. Include: print, electronic, specialists, other resource people. (ELA: S1: 3.1.4, 3.2.3; Math: S1-B-1, 2; TFS 2.2.1) GLO: C2, C4, C6; TFS: 1.3.2, 4.3.4</p> <p>S1-0-2c. Summarize and record information in a variety of forms. Include: paraphrasing, quoting relevant facts and opinions, proper referencing of sources. (ELA: S1: 3.3.2) GLO: C2, C4, C6; TFS: 2.3.1, 4.3.4</p> <p>S1-0-5c. Record, organize, and display data using an appropriate format. Include: labelled diagrams, graphs, multimedia (ELA: S1: 4.1.1, 4.1.2) GLO: C2, C5; TFS: 1.3.1, 3.2.2</p> <p>S1-0-7e. Reflect on prior knowledge and experiences to develop new understanding. (ELA: S1: 4.2.1) GLO: C2, C3, C4</p> <p>S1-0-8c. Describe examples of how scientific knowledge has evolved in light of new evidence, and the role of technology in this evolution. GLO: A2, A5</p> <p>S1-0-8d. Describe examples of how technologies have evolved in response to changing needs and scientific advances. GLO: A5</p>

SUGGESTIONS FOR INSTRUCTION

(3 HOURS)

➤ **Entry-Level Knowledge**

In Grade 6, students focussed on our solar system and discussed the relative positions of planets, and the general physical differences between them based on their position from the Sun. Students also studied the Moon phases and eclipses.

➤ **Notes for Instruction**

Discussion of all the celestial objects would be time consuming. Help students to differentiate between the various objects, noting their composition, general characteristics, their relative size, and their distance from the Earth. They should have a basic understanding of what each celestial item on the list is, be able to describe its relationship to the solar system, and have a first approximation as to the size of the object and its composition.

Discuss briefly that our Sun is a star, but it may be appropriate to give students the scientific explanation of how a star forms. Most students find this very interesting and want to know how our Sun fits into a star’s life cycle. It is not necessary to discuss the Hertzsprung-Russell Diagram, but some background discussions about star formation from gaseous nebulae and the typical “life cycle” of a star such as our Sun may be appropriate. Students should be made aware that there are many classes (families) of stars, but all are based on three intrinsic properties — their surface temperature, mass, and luminosity.

➤ **Student Learning Activities**

Student Research/Reports S1-0-2a, 2c, 5c, 7e, 8c, 8d

Students or student groups summarize the information about the various celestial objects in a chart.

Students could also show the relationships among the celestial objects using a Web Mind Map (See *SYSTH*, page 11.8), a written summary, an artistic representation, a multimedia presentation, or a flip chart summary.

Visual Displays

Students sketch the shape of our Milky Way galaxy. Beside the galaxy, they sketch our solar system and its planets (proper scale is optional), using an arrow to pinpoint the location of the solar system in the Milky Way galaxy. Students complete the sketch with other correctly placed celestial objects, such as moons, comets, asteroids, nebulae, and stars.

Vocabulary: Because of the depth and richness of the terminologies in this outcome, an organizer may be necessary. Try using Appendix 4.8: The Great Astronomical Word Explosion.

SUGGESTIONS FOR ASSESSMENT

SUGGESTED LEARNING RESOURCES

Science 9

BLM 4-269

Sciencepower 9

13.4: Surveying the Solar System,
pp. 443–56

Investigation 13-C:

Consulting the Planetary Expert: You,
pp. 446–52

BLM 13-16 Planet Database

BLM 13-17 Planet Information
Sheet

Activity 4.7: Survey of the Cosmos

Appendices

4.8 Student Learning Activity
The Great Astronomical Word
Explosion

SYSTH

11.8 Developing Scientific
Concepts Using Graphic
Displays

PRESCRIBED LEARNING OUTCOMES
<i>Students will...</i>
<p>S1-4-09 Explain how various technologies have extended our ability to explore and understand space.</p> <p><i>Examples: robotics, Canadarm, Hubble telescope, Lunar Rover, shuttle, space station, Sojourner Rover, Pathfinder, and Galileo space probes...</i></p> <p>GLO: A5, B1, B2, D6</p>
Skills and Attitudes Outcomes
<p>S1-0-2a. Select and integrate information obtained from a variety of sources. Include: print, electronic, specialists, other resource people. (ELA: S1: 3.1.4, 3.2.3; Math: S1-B-1, 2; TFS 2.2.1) GLO: C2, C4, C6; TFS: 1.3.2, 4.3.4</p> <p>S1-0-2b. Evaluate the reliability, bias, and usefulness of information. (ELA: S1: 3.2.3, 3.3.3) GLO: C2, C4, C5, C8; TFS: 2.2.2, 4.3.4</p> <p>S1-0-2c. Summarize and record information in a variety of forms. Include: paraphrasing, quoting relevant facts and opinions, proper referencing of sources. (ELA: S1: 3.3.2) GLO: C2, C4, C6; TFS: 2.3.1, 4.3.4</p> <p>S1-0-7e. Reflect on prior knowledge and experiences to develop new understanding. (ELA: S1: 4.2.1) GLO: C2, C3, C4</p> <p>S1-0-8c. Describe examples of how scientific knowledge has evolved in light of new evidence, and the role of technology in this evolution. GLO: A2, A5</p> <p>S1-0-8d. Describe examples of how technologies have evolved in response to changing needs and scientific advances. GLO: A5</p> <p>S1-0-8e. Discuss how peoples of various cultures have contributed to the development of science and technology. GLO: A4, A5</p> <p>S1-0-9a. Appreciate and respect that science and technology have evolved from different views held by women and men from a variety of societies and cultural backgrounds. GLO: A4</p>

SUGGESTIONS FOR INSTRUCTION
(2 HOURS)

➤ **Entry-Level Knowledge**

In Grade 6, students focussed on human endeavours in space. Significant emphasis was placed on the technologies and spacecraft uniquely suited to habitation and research in that environment. Students examined how astronauts meet their basic needs in space, the societal impacts arising from space exploration, and the materials and technologies that emerged as a result of sending humans into space. In Senior 1, the new emphasis, however, will be the exploration via robotic, uninhabited spacecraft within the solar system.

➤ **Notes for Instruction**

New space probe endeavours are continuously being planned by various space agencies. Expose students to current reports of space exploration through websites, newspapers, magazines, etc. Students then use fact-based article analysis frames to analyze the information.

➤ **Student Learning Activities**

Collaborative Teamwork S1-0-2a, 2b, 8c, 8d

Student groups create a scrapbook of relevant newspaper and magazine articles and describe, using annotations, the connection to the learning outcome and the background knowledge needed to understand the articles.

Journal Writing S1-0-7e

Students complete a fact- or issue-based article analysis of a current newspaper or magazine article related to the topic of technologies and the exploration of space. (See *SYSTH*, pages 11.30, 11.40–11.41)

Students prepare a glossary of new words related to space exploration technologies.

Student Research S1-0-2a, 2c, 8e, 9a

Students engage in independent research of known Canadian and international contributions in this area, for instance

- the Canadarm for the Space Shuttle
- the International Space Station
- recent advances with the Hubble space telescope
- the Apollo program to the lunar surface
- the Mars Pathfinder/Sojourner Rover mission
- the Galileo mission to Jupiter and its largest moons
- the Cassini mission to Saturn and its moon Titan
- Jupiter’s moon Europa and the search for new life

SUGGESTIONS FOR ASSESSMENT

SUGGESTED LEARNING RESOURCES

Rubrics/Checklists

Rubrics or checklists can be used for peer-, self-, or teacher-assessment.

Written Quiz/Test

Students

- describe the International Space Station, and suggest reasons why it is important for understanding human endeavour in space.
- use a Compare and Contrast frame to differentiate between science and technology in terms of their purpose, procedures, and products related to the acquisition of new information about the cosmos. (See *SYSTH*, pages 10.15, 10.24)
- complete a fact- or issue-based article analysis of a current newspaper or magazine article related to the topic. (See *SYSTH*, pages 11.31, 11.40)
- write a newspaper article outlining current research and findings related to the topic.

Research Report/Presentation S1-0-2a, 2b, 2c

Students or student groups investigate a particular contribution to space exploration. Reports can be presented as

- written reports
- information technology presentations
- oral presentations
- cartoon/comic books
- posters
- newspaper articles
- pamphlets

Information can be gathered from a variety of sources. Word processing and desktop publishing software can be used for report writing.

Journals

Assess journal entries using a Journal Evaluation form. (See *SYSTH*, page 13.21)

Science 9

13.12: Probes to the Planets, p. 422

14.6: Telescopes, pp. 448–50
The Hubble Deep Field,
pp. 480–81

15.7: How Astronomers Use
Computers, pp. 482–83

Sciencepower 9

BLM 16-28 Terms and Acronyms

BLM 13-24 The Voyager Probes

BLM 15-11 Hubble Deep Field
Photograph

BLM 16-8 The Use of Space

BLM 16-9 Placing a Satellite in Orbit

BLM 16-11 Geosynchronous Satellites

BLM 16-15 Race to the Moon

SYSTH

10.15, 10.24 Building a Scientific
Vocabulary

11.30, 11.31
11.40–11.41 Developing Scientific
Concepts Using
Graphic Displays

13.21 Writing to Learn
Science

PRESCRIBED LEARNING OUTCOMES
<i>Students will...</i>
<p>S1-4-10 Investigate ways in which Canada participates in space research and in international space programs, and then use the decision-making process to address a related issue.</p> <p><i>Examples: International Space Station, Canadarm...</i></p> <p>GLO: A3, A4, B2, C4</p>
Skills and Attitudes Outcomes
<p>S1-0-1c. Identify STSE issues which could be addressed. GLO: C4</p> <p>S1-0-1d. Identify stakeholders and initiate research related to an STSE issue. (ELA: S1: 3.1.4, 4.4.1) GLO: C4</p> <p>S1-0-2a. Select and integrate information obtained from a variety of sources. Include: print, electronic, specialists, other resource people. (ELA: S1: 3.1.4, 3.2.3; Math: S1-B-1, 2; TFS 2.2.1) GLO: C2, C4, C6; TFS: 1.3.2, 4.3.4</p> <p>S1-0-2b. Evaluate the reliability, bias, and usefulness of information. (ELA: S1: 3.2.3, 3.3.3) GLO: C2, C4, C5, C8; TFS: 2.2.2, 4.3.4</p> <p>S1-0-2c. Summarize and record information in a variety of forms. Include: paraphrasing, quoting relevant facts and opinions, proper referencing of sources. (ELA: S1: 3.3.2) GLO: C2, C4, C6; TFS: 2.3.1, 4.3.4</p> <p>S1-0-3d. Summarize relevant data and consolidate existing arguments and positions related to an STSE issue. (ELA: S1: 1.2.1, 3.3.1, 3.3.2) GLO: C4; TFS: 2.3.1, 4.3.4</p> <p>S1-0-3e. Determine criteria for the evaluation of an STSE decision. <i>Examples: scientific merit; technological feasibility; social, cultural, economic, and political factors; safety; cost; sustainability...</i> GLO: B5, C1, C3, C4</p> <p>S1-0-8d. Describe examples of how technologies have evolved in response to changing needs and scientific advances. GLO: A5</p>

SUGGESTIONS FOR INSTRUCTION

(3 HOURS)

➤ Entry-Level Knowledge

In K–8 Science, students experienced the design process, but may not have had any experience with formal decision-making processes.

➤ Notes for Instruction

Discuss surveillance satellites and Canada’s involvement in space research, while guiding students through the decision-making process.

The Decision-Making Model, as presented in the *Senior 1 Science Framework*, outlines the steps that could be followed. Model the process at first, giving concrete examples. Remember that it is the process as much as the final decision that is important. Use the 0 Cluster (Skills Outcomes) as a guide to the Decision-Making Model.

➤ Student Learning Activities

Class Discussion S1-0-1c

Students brainstorm a list of STSE issues that could be addressed. For example:

- Should the cost of Canada’s contribution to a space research program exceed the amount of money spent on health care?
- Should the cost of Canada’s contribution to a space research program exceed the amount of money spent on education?
- Should humans be sent into space when the risks and costs are so extreme?
- Should space research be funded only when the research has a direct, tangible benefit to quality of life?

Note: It is important that information for the issue be readily available. Federal organizations may be able to supply some data, but some issues will depend on student opinion and may be more difficult to process.

Student Research/Reports S1-0-1d, 3d, 3e,

Students or student groups brainstorm to identify stakeholders and initiate research related to the STSE issue (e.g., ask an expert like a local MP, use the Internet to ask an expert, perform a general Internet search, etc.).

Students summarize relevant data and consolidate existing arguments and positions related to the selected STSE issue. Students may need assistance to identify two opposing points of view so that their research will have a defined focus.

Students determine which criteria will be used to evaluate the STSE decision (e.g., scientific merit; technological feasibility; social, cultural, economic, and political factors; safety; cost; etc.).

SUGGESTIONS FOR ASSESSMENT

SUGGESTED LEARNING RESOURCES

Rubrics/Checklists

Rubrics or checklists can be used for peer-, self-, or teacher-assessment.

Journals

Students

- complete a Word Cycle of terms related to space exploration. (See *SYSTH*, page 10.21)
- write an essay defending their opinion of the merits of pursuing a particular mission in space, whether inhabited or robotic.
- complete a fact- or issue-based article analysis of a current newspaper or magazine about issues surrounding the human exploration of space or long-distance flights to other planets. (See *SYSTH*, pages 11.30–11.31)
- write a newspaper article outlining current research and findings related to the topic.

Assess journal entries using a Journal Evaluation form. (See *SYSTH*, page 13.21)

Research Report/Presentation

Students or student groups investigate a particular application/issue. Reports can be presented as

- written reports
- oral presentations
- posters
- pamphlets
- information technology presentations
- debates
- newspaper articles
- dramatic presentations
- multimedia presentations

Information can be gathered from a variety of sources. Word processing and desktop publishing software can be used for report writing. Computer-based presentations should be strongly encouraged.

Science 9

14.2: Explore an Issue — Who Owns the Solar System?, pp. 440–41

16.3: Earth-Orbit Satellites, pp. 492–95

16.4: Case Study — Radarsat, p. 496

16.6: The International Space Station, pp. 498–99

Sciencepower 9

16.3: Issues in Space Exploration, pp. 536–40

Ask an Expert, pp. 550–51

Issue Analysis: Merits of Space Travel Using Astronauts, pp. 552–53

BLM 16-1 International Space Station

BLM 16-18 Issues in Space Exploration

BLM 16-24 Astronaut Biographies- Investigation 16C

Appendices

4.9 Student Learning Activity Weighing the Benefits and Risks of Space Exploration

4.10 Student Learning Activity Canadian Projects in the Space Sciences

5.6 Rubric for the Assessment of a Decision-Making Process Activity

SYSTH

10.21 Building a Scientific Vocabulary

11.30–11.31 Developing Scientific Concepts Using Graphic Displays

13.21 Journal Evaluation

PRESCRIBED LEARNING OUTCOMES
<i>Students will...</i>
<p>S1-4-11 Evaluate the impact of space science and technologies in terms of their benefits and risks to humans.</p> <p><i>Examples: search for extraterrestrial life and habitat, remote sensing, predictions of potentially catastrophic impacts, colonization of space by only a few countries...</i></p> <p>GLO: A3, B1, B2, B5</p>
Skills and Attitudes Outcomes
<p>S1-0-1c. Identify STSE issues which could be addressed. GLO: C4</p> <p>S1-0-1d. Identify stakeholders and initiate research related to an STSE issue. (ELA: S1: 3.1.4, 4.4.1) GLO: C4</p> <p>S1-0-2a. Select and integrate information obtained from a variety of sources. Include: print, electronic, specialists, other resource people. (ELA: S1: 3.1.4, 3.2.3; Math: S1-B-1, 2; TFS 2.2.1) GLO: C2, C4, C6; TFS: 1.3.2, 4.3.4</p> <p>S1-0-2c. Summarize and record information in a variety of forms. Include: paraphrasing, quoting relevant facts and opinions, proper referencing of sources. (ELA: S1: 3.3.2) GLO: C2, C4, C6; TFS: 2.3.1, 4.3.4</p> <p>S1-0-2d. Review effects of past decisions and various perspectives related to an STSE issue. <i>Examples: government's, public, environmentalists', and First Nations' positions.</i> (ELA: S1: 3.2.2) GLO: B1, C4; TFS: 1.3.2, 4.3.4</p> <p>S1-0-3d. Summarize relevant data and consolidate existing arguments and positions related to an STSE issue. (ELA: S1: 1.2.1, 3.3.1, 3.3.2) GLO: C4; TFS: 2.3.1, 4.3.4</p> <p>S1-0-5a. Select and use appropriate methods and tools for collecting data or information. GLO: C2; TFS: 1.3.1</p> <p>S1-0-5c. Record, organize, and display data using an appropriate format. Include: labelled diagrams, graphs, multimedia (ELA: S1: 4.1.1, 4.1.2) GLO: C2, C5; TFS: 1.3.1, 3.2.2</p> <p>S1-0-7a. Draw a conclusion that explains the results of an investigation. Include: cause and effect relationships, alternative explanations, supporting or rejecting the hypothesis or prediction. (ELA: S1: 3.3.4) GLO: C2, C5, C8</p>

SUGGESTIONS FOR INSTRUCTION

(1-1/2 HOURS)

➤ Entry-Level Knowledge

In Grade 6, students identified technological devices placed in space that helped humans learn more about the Earth.

➤ Notes for Instruction

Teachers may find students making a significant contribution to this topic. The suggested examples of space research should be examined carefully for their benefits and risks to humans and the impact of space science and technologies on society. Students should be able to describe several positive and negative aspects and thereby gain a richer understanding of the issues involved.

Extend the suggested list of examples to reflect your own experience and the experience of your class.

Consult the popular media (motion pictures, television, periodicals, and websites) for examples, as they regularly cover these topics. Students can learn important lessons that will help them sort out good science from trivial, pseudoscientific portrayals.

The Decision-Making Model, as presented in the *Senior 1 Science Framework*, outlines the steps that could be followed. At first, model the process, then act as a guide.

➤ Student Learning Activities

Journal Writing S1-0-1c, 1d, 2c, 2d, 3d, 6d, 7b, 7c, 7d

Students reflect on the pros and cons of

- searching the heavens for radio frequency signals indicative of communicating civilizations.
- the use of near-Earth space by a few industrialized nations.

Students complete a fact- or issue-based article analysis of a current newspaper or magazine article related to one of the examples given in this outcome. The risks associated with Earth-crossing comets and asteroids are often popular in the media. (See *SYSTH*, pages 11.30–11.31, 11.40)

Students compose fictitious accounts of mission to other worlds, including the type of environments encountered, atmospheric composition, geology, potential for novel life forms, etc. A RAFTS format could be used. Students are to be as scientifically credible as possible with the elements in their stories.

(continued)

SUGGESTIONS FOR ASSESSMENT

SUGGESTED LEARNING RESOURCES

Research Report/Presentation

Students or student groups investigate an example of a space research technology that has been demonstrated to be potentially beneficial/harmful to the environment on Earth. Reports can be presented as

- written reports
- oral presentations
- posters
- pamphlets
- information technology presentations

Extraterrestrial Laboratory Report

Students prepare a report outlining the results from a recent probe sent to one of the moons of an outer planet (e.g., Saturn or Neptune), including an argument supporting the return to that world for further research.

Visual Display

Students or student groups prepare visual displays of the most recent events in space exploration, outlining both the successful missions and those that ended in failure. Displays may include

- posters
- diagrams
- information technology presentations
- concept maps
- models of the spacecraft involved
- technical data

Written Test/Quiz

Students answer the following questions:

- What is SETI? Describe its goals and some of the scientific/technological efforts that are involved in its mission.
- What experiments would you set up in order to test a planet's surface materials for "hostile" organisms that could contaminate the Earth's biosphere?
- What risks are posed to the Earth from what are known as "near-Earth objects?" Should we develop a space-based defense system to shield ourselves from such objects?
- Will we face the same fate as the dinosaurs from the risks of being on "spaceship Earth?" Support your answer with evidence.

Science 9

Activity 16.9 Spin-offs from the Space Industry, p 506

Investigation 16.11:
Experimenting in Free-Fall
Conditions, p. 510

Activity 16.12 Explore an Issue —
Our Future in Space,
p. 511

Sciencepower 9

BLM 16-20 Viking's Tests for Life
on Mars

BLM 16-21 Messages to Space

BLM 16-22 SETI: the Arecibo
Message

BLM 16-23 Who Might be Picking
Up Earth's Signals?

BLM 16-2 The Effect of Celestial
Bodies on Earth

BLM 16-11 Geosynchronous
Satellites

BLM 16-15 Race to the Moon

BLM 16-17 Space Exploration
Spin-offs

BLM 16-19 Joseph Kittinger —
The Man Who Fell to
Earth

BLM 16-20 Viking's Tests for Life
on Mars

BLM 16-27 Space Resumé

BLM 16-28 Terms and Acronyms

SYSTH

11.30–11.31

11.40 Developing Scientific
Concepts Using
Graphic Displays

13.23 Writing to Learn Science

(continued)

PRESCRIBED LEARNING OUTCOMES
<i>Students will...</i>
(continued) S1-4-11 Evaluate the impact of space science and technologies in terms of their benefits and risks to humans. <i>Examples: search for extraterrestrial life and habitat, remote sensing, predictions of potentially catastrophic impacts, colonization of space by only a few countries...</i> GLO: A3, B1, B2, B5
Skills and Attitudes Outcomes
S1-0-3e. Determine criteria for the evaluation of an STSE decision. <i>Examples: scientific merit; technological feasibility; social, cultural, economic, and political factors; safety; cost; sustainability...</i> GLO: B5, C1, C3, C4 S1-0-3f. Formulate and develop options which could lead to an STSE decision. GLO: C4 S1-0-4d. Use various methods for anticipating the impacts of different options. <i>Examples: test run, partial implementation, simulation, debate...</i> GLO: C4, C5, C6, C7 S1-0-5d. Evaluate, using pre-determined criteria, different STSE options leading to a possible decision. Include: scientific merit; technological feasibility; social, cultural, economic, and political factors; safety; cost; sustainability. (ELA: S1: 3.3.3) GLO: B5, C1, C3, C4; TFS: 1.3.2, 3.2.3 S1-0-7b. Select the best option and determine a course of action to implement an STSE decision. GLO: B5, C4 S1-0-7c. Implement an STSE decision and evaluate its effects. GLO: B5, C4, C5, C8 S1-0-7d. Reflect on the process used to arrive at or to implement an STSE decision, and suggest improvements. (ELA: S1: 5.2.4) GLO: C4, C5

SUGGESTIONS FOR INSTRUCTION
(1-1/2 HOURS)

➤ **Student Learning Activities (continued)**

Problem Solving

Students complete a learning activity based on Drake’s Equation. (See Appendix 4.6)

Collaborative Teamwork S1-0-1c, 1d, 2d, 3d, 5d, 7b

Students prepare and present mock interviews with people who have been involved in research into the existence of extraterrestrial life (SETI) (e.g., Dr. Frank Drake, Director of the SETI Institute, and the late Dr. Carl Sagan).

Students hold a mock Royal Commission on the issue of Canadian involvement in the development and deployment of space-based weapons systems. Students identify the issue and stakeholders, break into groups representing the stakeholders, research the issue from their point of view, and present their briefs as public hearings. Class discussions are held after all briefs have been presented, and recommendations for a course of action are developed. The Decision-Making Model from the *Senior 1 Science Framework* could be used in this learning activity.

Class Discussion S1-0- 3e, 3f, 4d, 5d

Students debate the pros and cons of investing in the potential applications available from the development of new space-related materials, instruments, and related technologies.

SUGGESTIONS FOR ASSESSMENT

SUGGESTED LEARNING RESOURCES

Appendices

- 4.6 Student Learning Activity
The Search for Extraterrestrial Intelligence — the Drake Equation
- 4.9 Student Learning Activity
Weighing the Benefits and Risks of Space Exploration

Teacher Background

The search for extraterrestrial life (SETI) is an excellent example of how serious science can be distorted and corrupted by popularized accounts. The UFO debate is just one such situation. It may be instructive for students to know that the SETI program is a well-funded attempt at scanning the heavens for transmissions that may originate from past or presently communicating intelligent lifeforms. One of the founding members of the SETI research community, Dr. Frank Drake, developed an interesting probability relationship that has become known as the Drake Equation. By entering values for certain parameters in this equation, one can determine within statistical error the number of intelligent, communicating civilizations in our galaxy.

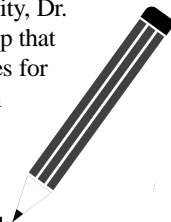

NOTES