

# Grade 11 Chemistry

A Foundation for  
Implementation

# ***GRADE 11 CHEMISTRY***

*A Foundation for Implementation*

**2006**

Manitoba Education, Citizenship and Youth

## **Manitoba Education, Citizenship and Youth Cataloguing in Publication Data**

530.0712      Grade 11 chemistry : a foundation for implementation

ISBN 0-7711-3438-X

1. Chemistry—Study and teaching (Secondary)—Manitoba. 2. Chemistry—Curricula. 3. Chemistry—Study and teaching (Secondary). I. Manitoba. Manitoba Education, Citizenship and Youth.

Copyright © 2006, the Crown in Right of Manitoba as represented by the Minister of Education, Citizenship and Youth. Manitoba Education, Citizenship and Youth, School Programs Division, 1970 Ness Avenue, Winnipeg, Manitoba R3J 0Y9.

Every effort has been made to acknowledge original sources and to comply with copyright law. If cases are identified where this has not been done, please notify Manitoba Education, Citizenship and Youth. Errors or omissions will be corrected in a future edition. Sincere thanks to the authors and publishers who allowed their original material to be adapted or reproduced.

This document is also available on the Manitoba Education, Citizenship and Youth website at <<http://www.edu.gov.mb.ca/k12/cur/science/scicurr.html>>.

## ACKNOWLEDGEMENTS

Manitoba Education, Citizenship and Youth gratefully acknowledges the contributions of the following individuals in the development of *Grade 11 Chemistry: A Foundation for Implementation*.

### Principal Writer

George D. Bush                      Consulting Science Educator                      Winnipeg, Manitoba

### Chemistry Education and Senior Curriculum Advisor

Brian Lewthwaite                      Faculty of Education                      University of Manitoba

### Members of the Manitoba Development Team for *Grade 11 Chemistry: A Foundation for Implementation*

Madeleine Asselin	Collège Louis-Riel	Division scolaire franco-manitobaine
George D. Bush	Consulting Science Educator	Winnipeg, Manitoba
Kelly Choy	Minnedosa Collegiate	Rolling River S.D.
Kris Coulter	St. John's High School	The Winnipeg S.D.
Claude Garand	Education Program	The University of Winnipeg (until January 2004)
Leona Groot	Gimli High School	Evergreen S.D.
Jennifer Kirk	Balmoral Hall School	Independent Schools
Kent Lewarne	Pilot Mound School	Prairie Spirit S.D.
Angela Russenholt	J.H. Bruns Collegiate	Louis Riel S.D.
Rick Wiebe	John Taylor Collegiate	St. James-Assiniboia S.D.

### Graphics Design

Rick Wiebe                      John Taylor Collegiate                      St. James-Assiniboia S.D.

### Kindergarten to Grade 12 Science Steering Committee

Ron Banister	Manitoba Teachers' Society	The Winnipeg S.D.
Sharon Burns	Manitoba Association of Parent Councils	
Randy Cielen	Springfield Collegiate	Sunrise S.D.
Paul D. Cuthbert	Manitoba Association of School Superintendents	Evergreen S.D.
J. David Graham	Health and Applied Sciences	Red River College
Kay Harvey	Manitoba Association of School Trustees	Sunrise S.D.
Veronica Klassen	Wapanohk-Eastwood Community School	Mystery Lake S.D. (until June 2003)
Derrick Pokrant	Science Teachers' Association of Manitoba	River East-Transcona S.D. (since October 2002)

**Kindergarten to Grade 12 Science Steering Committee (continued)**

G. Gordon Robinson	Faculty of Science	University of Manitoba (until September 2002)
Rick Skarban	Councils for School Leadership	Mystery Lake S.D.
Deb Spelchak	Glenlawn Collegiate	Division scolaire Louis-Riel
Dawn L. Sutherland	Education Program	The University of Winnipeg (until June 2003)

**School Programs Division Staff**

Lee-Ila Bothe	Coordinator	Document Production Services Instruction, Curriculum and Assessment Branch
Diane Cooley	Acting Director	Instruction, Curriculum and Assessment Branch
Sandra Drummond	Administrative Assistant	Development Unit Instruction, Curriculum and Assessment Branch
Lynn Harrison	Desktop Publisher	Document Production Services Instruction, Curriculum and Assessment Branch
Susan Letkemann	Publications Editor	Document Production Services Instruction, Curriculum and Assessment Branch
John James Murray	Project Leader	Development Unit Instruction, Curriculum and Assessment Branch
Aileen Najdich	Project Manager	Development Unit Instruction, Curriculum and Assessment Branch

**Bureau de l'éducation française Division Staff**

Jean-Vianney Auclair	Director	Bureau de l'éducation française (until January 2006)
Danièle Dubois-Jacques	Consultant	Bureau de l'éducation française

# CONTENTS

---

## Acknowledgements *iii*

## Introduction **1**

- Background 1
- Vision for Scientific Literacy 1
- Goals for Canadian Science Education 2
- Beliefs about Learning, Teaching, and Assessing Science 2
- Changing Emphases in Science 3
- Processes That Engage Students in Science Learning 5

## Section 1: Manitoba Foundations for Scientific Literacy **1**

- The Five Foundations 3
- Nature of Science and Technology 4
- Science, Technology, Society, and the Environment (STSE) 6
- Scientific and Technological Skills and Attitudes 9
- Essential Science Knowledge 12
- The Unifying Concepts 13
- Kindergarten to Grade 10 Science Topic Chart 15

## Section 2: Implementation of Grade 11 Chemistry **1**

- The Senior Years Student and the Science Learning Environment 3
- Effective Teaching in Chemistry: What the Research Says to Teachers 14
- Unit Development in Chemistry 17
- A View of Chemistry Education: Toward Modes of Representation 18
- The Modes of Representation 18
- Toward an Instructional Philosophy in Chemistry 25

## Section 3: Assessment in Grade 11 Chemistry **1**

- Classroom Assessment 3
- Planning for Assessment 3
- Characteristics of Effective Assessment 4
- Managing Classroom Assessment 8
- Changing Emphases in Assessment 10
- Types of Assessment 11

## Section 4: Document Organization **1**

- Document Organization and Format 3
- Guide to Reading the Learning Outcomes and the Document Format 3
- Sample Two-Page Layout 6
- General Learning Outcomes 8
- Cluster 0: Skills and Attitudes Outcomes 10
- Specific Learning Outcomes 13

**Grade 11 Chemistry 1**

Topic 1: Physical Properties of Matter 1

Topic 2: Gases and the Atmosphere 1

Topic 3: Chemical Reactions 1

Topic 4: Solutions 1

Topic 5: Organic Chemistry 1

**Appendices 1**

**Topic 1 Appendices 1**

Appendix 1.1: Demonstrating Diffusion on the Overhead Projector 3

Appendix 1.2: A “Real” Water Fountain 5

Appendix 1.3: Popping the Kernel: Modelling the States of Matter 6

Appendix 1.4: Kinetic Energy Distribution 10

Appendix 1.5: Bond Types and Conductivity 11

Appendix 1.6: Chemistry Review Form 15

Appendix 1.7: Making Fingerprints Visible 16

Appendix 1.8: Probeware Investigation: Determining Melting Points 17

Appendix 1.9: Vapour Pressure with Pop 22

Appendix 1.10: Measuring the Vapour Pressure of a Liquid 24

Appendix 1.11: Forces between Particles 27

Appendix 1.12: Freezing by Boiling 31

Appendix 1.13: Gas Laws: Temperature and Pressure Changes 32

Appendix 1.14: Chemistry Is Super: “Bingo” Review Game 36

**Topic 2 Appendices 1**

Appendix 2.1: Can You Vacuum Pack a Person? 3

Appendix 2.2: A Historical Timeline of the Measurement of Pressure 4

Appendix 2.3: The Drinking Bird 7

Appendix 2.4: Make Your Own Cartesian Diver 10

Appendix 2.5: Charles’s Law: The Temperature-Volume Relationship in Gases 14

Appendix 2.6: Charles’s Law 16

Appendix 2.7: Charles’s Law Lab 17

Appendix 2.8: Applications of Gases in Our Lives 19

Appendix 2.9: Review Game 22

**Topic 3 Appendices 1**

Appendix 3.1: Calculating Average Atomic Mass 3

Appendix 3.2: Don’t Be an Isotope: Get the Facts on Isotopes 5

Appendix 3.3: Isotopes Used in Medicine and Climatology 9

Appendix 3.4: The Importance and Application of Isotopes 10

Appendix 3.5: Names, Formulas, and Charges of Some Common Ions 18

Appendix 3.6: Ionic Name Game 19

Appendix 3.7: Stoichiometry: The Formula of a Precipitate 20

Appendix 3.8: Indications of Chemical Reactions 26

Appendix 3.9: Determining the Molar Mass of a Gas 31

Appendix 3.10: Gas Density Table 35

Appendix 3.11: Creative Mole: Writing Activity 36

- Appendix 3.12: The Stoichiometry of Gasoline: Internet Research Activity 37
- Appendix 3.13: How to Solve a Limiting Reactant Problem 38
- Appendix 3.14: The Behaviour of Solid Copper Immersed in a Water Solution of the Compound Silver Nitrate 39
- Appendix 3.15: A Quantitative Investigation of the Reaction of a Metal with Hydrochloric Acid 43
- Appendix 3.16: Stoichiometry: Reactants, Products, and Enthalpy Changes 48

**Topic 4 Appendices 1**

- Appendix 4.1: Polar and Non-polar Substances 3
- Appendix 4.2: Why Don't Water and Oil Mix? 7
- Appendix 4.3: Constructing a Solubility Curve 8
- Appendix 4.4: Unsaturated, Saturated and Supersaturated Solutions 13
- Appendix 4.5: Crystals and Crystal Growing 15
- Appendix 4.6: Solubility Curve 17
- Appendix 4.7: The Effects of Salt and Antifreeze on the Melting Point of Ice 18
- Appendix 4.8: The Effect of Antifreeze on the Boiling Point of Water 19
- Appendix 4.9: Heat Transfer: I Scream, You Scream, We All Scream for Ice Cream 20
- Appendix 4.10: The Effect of Salt on the Melting Point of Ice 22
- Appendix 4.11: A WebQuest for Solubility Units 25
- Appendix 4.12: Solutions: A Scavenger Hunt 26

**Topic 5 Appendices 1**

- Appendix 5.1: Underwater Fireworks 3
- Appendix 5.2: Preparation of Esters 6
- Appendix 5.3: Organic Model-Building Presentation 9
- Appendix 5.4: Esters: Flavours and Fragrances 10

**General Appendices 1**

- Appendix 6: Scientific Communication 3
- Appendix 7: Research 11
- Appendix 8: Assessment 17
- Appendix 9: Developing Assessment Rubrics in Science 23
- Appendix 10: Assessment Rubrics 29
- Appendix 11: General and Specific Learning Outcomes 39

**Bibliography 1**





# INTRODUCTION

## Background

*Grade 11 Chemistry: A Foundation for Implementation* presents student learning outcomes for Grade 11 Chemistry. These learning outcomes are the same for students in the English, French Immersion, Français, and Senior Years Technology Education Programs, and result from a partnership involving two divisions of Manitoba Education, Citizenship and Youth: School Programs Division and Bureau de l'éducation française Division.

Student learning outcomes are concise descriptions of the knowledge and skills [and attitudes] that students are expected to learn in a course or grade in a subject area (Manitoba Education and Training, *A Foundation for Excellence* 14).

Manitoba's student learning outcomes for Grade 11 Chemistry are based, in part, on those found within the *Common Framework of Science Learning Outcomes K to 12: Pan-Canadian Protocol for Collaboration on School Curriculum* (Council of Ministers of Education, Canada) and on those developed as components of the 1998 Manitoba Transitional Curricula. The former, commonly referred to as the *Pan-Canadian Science Framework*, was initiated under the Pan-Canadian Protocol for Collaboration on School Curriculum (1995). It was developed by educators from Manitoba, Saskatchewan, Alberta, British Columbia, the Northwest Territories, the Yukon Territory, Ontario, and the Atlantic Provinces.

*Grade 11 Chemistry: A Foundation for Implementation* provides the basis for learning, teaching, and assessing chemistry in Manitoba. This document also serves as a starting point for future development of curriculum support documents, related teacher support materials, learning resources, assessment tools, and professional learning for teachers. This document also complements the *Pan-Canadian Science Framework* by providing support for its implementation, including suggestions for instruction and assessment.

## Vision for Scientific Literacy

Factors such as global interdependence, rapid scientific and technological innovation, the need for a sustainable environment, economy, and society, and the pervasiveness of science and technology in daily life reinforce the importance of scientific literacy. Scientifically literate individuals can more effectively interpret information, solve problems, make informed decisions, accommodate change, and achieve new understandings. Science education makes possible the development of the foundations necessary to develop a functional scientific literacy and assists in building stronger futures for Canada's young people.

The *Pan-Canadian Science Framework* and *Grade 11 Chemistry: A Foundation for Implementation* support and promote an attainable and realistic vision for scientific literacy.

The [*Pan-Canadian Science Framework*] is guided by the vision that all Canadian students, regardless of gender or cultural background, will have an opportunity to develop scientific literacy. Scientific literacy is an evolving combination of the science-related attitudes, skills, and knowledge students need to develop inquiry, problem-solving, and decision-making abilities, to become lifelong learners, and to maintain a sense of wonder about the world around them.

Diverse learning experiences based on the [*Pan-Canadian Science Framework*] will provide students with many opportunities to explore, analyze, evaluate, synthesize, appreciate, and understand the interrelationships among science, technology, society, and the environment that will affect their personal lives, their careers, and their future (Council of Ministers of Education, Canada 4).

### **Goals for Canadian Science Education**

Several goals promoting the achievement of scientific literacy within Canadian science education were developed as part of the *Pan-Canadian Science Framework*. These goals are addressed through the Manitoba science curricula. It is hoped that science education will

- encourage students at all levels to develop a rational sense of wonder and curiosity about scientific and technological endeavours
- enable students to use science and technology to acquire new knowledge and to solve problems, so they may improve the quality of their own lives and the lives of others
- prepare students to address science-related societal, economic, ethical, and environmental issues critically
- provide students with a proficiency in science that creates opportunities for them to pursue progressively higher levels of advanced study, prepares them for science-related occupations, and engages them in science-related activities appropriate to their interests and abilities
- develop in students of varying aptitudes and interests a knowledge of the wide variety of careers related to science, technology, and support for the natural and human environments

### **Beliefs about Learning, Teaching, and Assessing Science**

To promote a rational, achievable approach to developing scientific literacy among future citizens, it is crucial to recognize how students learn, how science can best be taught, and how learning can be assessed. Students are curious, active learners who have individual interests, abilities, and needs. They come to school with prior knowledge and various personal and cultural experiences that generate a range of attitudes and beliefs about science and life, and connections between these realms.

Students learn most effectively – in a Piagetian sense – when their study of science is rooted in concrete learning experiences related to a particular context or situation, and applied to their world of experiences, where appropriate. Ideas and understandings that students develop should be progressively extended and reconstructed as students grow in their experiences and in their ability to conceptualize more deeply. Learning involves the process of linking newly constructed understandings with prior knowledge, and then adding new contexts and experiences to current understandings. It is increasingly important that chemistry educators draw professional attention to how fundamental research in learning theory will affect their efforts in the science classroom.

### Changing Emphases in Science

Student learning outcomes in Grade 11 Chemistry encompass changing emphases in *science education content delivery* and changing emphases to promote *inquiry*, as envisioned in the *National Science Education Standards* (National Research Council 113).

<b>Changing Emphases in Science Education Content Delivery</b>	
The <i>National Science Education Standards</i> envision change throughout the system. The science content standards [or student learning outcomes] encompass the following changes in emphases:	
<b>Less Emphasis On</b>	<b>More Emphasis On</b>
Knowing scientific facts and information	Understanding scientific concepts and developing abilities of inquiry
Studying subject matter disciplines (physical, life, earth sciences) for their own sake	Learning subject matter disciplines in the context of inquiry, technology, science in personal and social perspectives, and history and nature of science
Separating science knowledge and science process	Integrating all aspects of science content
Covering many science topics	Studying a few fundamental science concepts
Implementing inquiry as a set of processes	Implementing inquiry as instructional strategies, abilities, and ideas to be learned

**Changing Emphases in Science Education Content Delivery:** Reprinted with permission from *National Science Education Standards*. Copyright © 1996 by the National Academy of Sciences, courtesy of the National Academies Press, Washington, DC.

<b>Changing Emphases to Promote Inquiry</b>	
<p>The <i>National Science Education Standards</i> envision change throughout the system. The science content standards [or student learning outcomes] encompass the following changes in emphases:</p>	
<b>Less Emphasis On</b>	<b>More Emphasis On</b>
Activities that demonstrate and verify science content	Activities that investigate and analyze science questions
Investigations confined to one class period	Investigations over extended periods of time
Process skills out of context	Process skills in context
Individual process skills such as observation or inference	Using multiple process skills—manipulation, cognitive, procedural
Getting an answer	Using evidence and strategies for developing or revising an explanation
Science as exploration and experiment	Science as argument and explanation
Providing answers to questions about science content	Communicating science explanations
Individuals and groups of students analyzing and synthesizing data without defending a conclusion	Groups of students often analyzing and synthesizing data after defending conclusions
Doing a few investigations in order to leave time to cover large amounts of content	Doing more investigations in order to develop understanding, ability, values of inquiry, and knowledge of science content
Concluding inquiries with the result of the experiment	Applying the results of experiments to scientific arguments and explanations
Management of materials and equipment	Management of ideas and information
Private communication of student ideas and conclusions to teacher	Public communication of student ideas and work to classmates

**Changing Emphases to Promote Inquiry:** Reprinted with permission from *National Science Education Standards*. Copyright © 1996 by the National Academy of Sciences, courtesy of the National Academies Press, Washington, DC.

## Processes That Engage Students in Science Learning

Development of increased scientific literacy is supported by instructional environments that engage students in the following:

- **Science inquiry:** Students are encouraged to converse, ask penetrating questions, and then seek to explore their own constructed explanations alongside scientific explanations through guided research, writing, and planned investigations.
- **Problem solving:** Students apply their acquired expertise and knowledge in novel, often unforeseeable, ways.
- **Decision making:** As students identify rich, large-context problems, questions, or issues related to the human and robotic exploration of the universe, they pursue new knowledge that will assist them in making informed, rational, defensible decisions that are rooted in the societal and humanistic domains within which science practice operates.
- **The nature of science:** Students appreciate and value the understanding that science operates with the consent of personal, social, political, environmental, and multicultural orientations of the global society. Moreover, there are consequences when science circumvents its responsibilities among these societal contexts.
- **Science-related skills:** Examples of science-related skills include initiating, planning, performing, recording, analyzing, interpreting, communicating, and team building. All these skills have central importance in learning the dimensions of science. It is important that science students of today not be taught the myth of a single, specifiable “scientific method” that leads to a superior “truth” about the material world. If there is indeed an objective “reality,” philosophers of science often agree that it may be difficult to define, or perhaps may be unknowable. Nevertheless, the methods of science systematically permit new knowledge domains to be constructed, and that knowledge is often robust and durable.
- **Science content knowledge:** Transmission of science content is no longer considered to be the primary outcome of science teaching. Science knowledge is actively constructed from existing and emerging personal and social knowledge. Creative, integrative, and interdisciplinary linkages should be balanced with the traditional “disciplinary focus” of teaching and learning in chemistry. Unifying concepts among traditional, bounded, restricted disciplines now give way to, and add form and substance to, new views of exploration among the sciences that are holistic and interdisciplinary.

Through these processes, students discover the significance of science in their lives and come to appreciate the interrelatedness of science, technology, society, and the environment. Each of these processes can be a starting point for science learning, and may encompass the exploration of new ideas, the development of specific investigations, and the application of ideas that are learned.

To achieve the vision of a scientific literacy for all according to personal interests and inclinations, students could become increasingly more engaged in the planning, development, and evaluation of their own learning experiences. They should have opportunities to work cooperatively with other students, to initiate investigations, to communicate their findings, and to complete projects that demonstrate their learning in a personal, although peer-reviewed, manner.

At the beginning of instructional design, teachers and students should identify expected student learning outcomes and establish performance criteria. It is important that these criteria correspond with provincial learning outcomes. This communication between students and teachers helps identify clearly what needs to be accomplished, thereby assisting in the learning process (see the rubrics in Appendix 10).

When students are aware of expected learning outcomes, they will be more focused on their learning, and may be more likely to assess their own progress. Furthermore, they can participate in creating appropriate assessment and evaluation criteria. Assessment methods must be valid, reliable, and fair to students.

# SECTION 1:

## MANITOBA FOUNDATIONS FOR SCIENTIFIC LITERACY

---

The Five Foundations	3
Nature of Science and Technology	4
Science, Technology, Society, and the Environment (STSE)	6
Scientific and Technological Skills and Attitudes	9
Essential Science Knowledge	12
The Unifying Concepts	13
Kindergarten to Grade 10 Science Topic Chart	15





# MANITOBA FOUNDATIONS FOR SCIENTIFIC LITERACY

## The Five Foundations

To develop scientifically literate students, Manitoba science curricula are built upon five foundations for scientific literacy that have been adapted from the *Pan-Canadian Science Framework* to address the needs of Manitoba students:

- Nature of Science and Technology
- Science, Technology, Society, and the Environment (STSE)
- Scientific and Technological Skills and Attitudes
- Essential Science Knowledge
- Unifying Concepts

The following conceptual organizer illustrates the five foundations for scientific literacy representing the goals of science learning from Kindergarten to Grade 12 in Manitoba.

## Manitoba Science Curriculum Conceptual Organizer

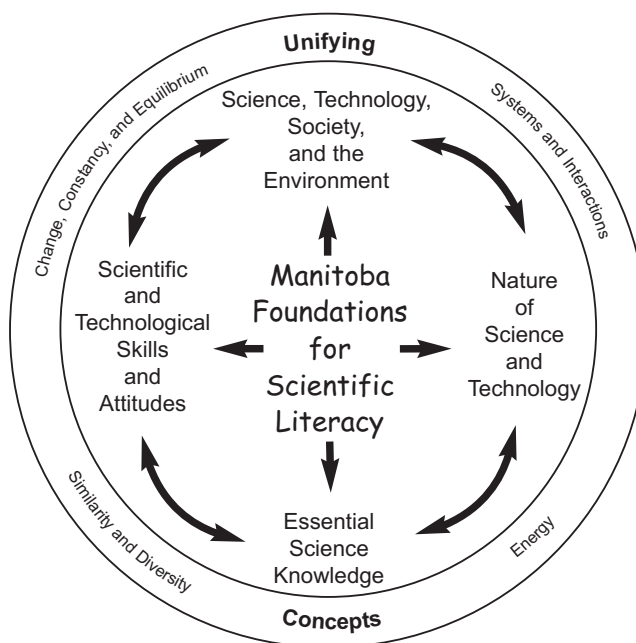

These foundations, which are described in more detail on the following pages, have led to the development of the general learning outcomes identified for Grade 11 Chemistry.

## Nature of Science and Technology

Students learn that science and technology are creative human activities with long histories in all cultures. Science is a way of learning about the universe. This learning stems from curiosity, creativity, imagination, intuition, exploration, observation, replication of experiments, interpretation of evidence, and debate over that evidence and its interpretations. Scientific activity involves predicting, interpreting, and explaining natural and human-made phenomena. Many historians, sociologists, and philosophers of science presently argue that there is no definable, set procedure for conducting a scientific investigation. Rather, they see science as driven by a combination of theoretical concerns, knowledge, experiments, and processes anchored in the physical world.

Producing science knowledge is an intrinsically collective endeavour. There is no such thing as stand-alone science done in isolation. Scientists submit models and solutions for the assessment of their peers, who judge their logical, rational and experimental soundness through reference to the body of existing knowledge and modes of representation (Larochelle and Désautels 235).

Scientific theories are being tested, modified, and refined continually as new knowledge and theories supersede existing knowledge bases. Scientific debate, both on new observations and on hypotheses that challenge accepted knowledge, involves many participants with diverse backgrounds. This highly complex interplay, which has occurred throughout history, is animated by theoretical discussions; experimentation; social, cultural, economic, and political influences; personal biases; and the need for peer recognition and acceptance. Students will realize that while some of our understandings about how the world works are due to revolutionary scientific developments, many of our understandings result from the steady and gradual accumulation of knowledge. History demonstrates, however, that great advances in scientific thought have completely uprooted certain disciplines, transplanting practitioners and theoreticians alike into an entirely new set of guiding assumptions. Such scientific revolutions, as discussed by Thomas S. Kuhn in his influential *The Structure of Scientific Revolutions*, constitute exemplars that can energize the science teaching enterprise – particularly in chemistry education.

Technology results mainly from proposing solutions to problems arising from human attempts to adapt to the external environment. Technology may be regarded as “a tool or machine; a process, system, environment, epistemology, and ethic; the systematic application of knowledge, materials, tools, and skills to extend human capabilities” (Manitoba Education and Training, *Technology As a Foundation Skill Area 1*). Technology refers to much more than the knowledge and skills related to computers and their applications. Technology is based on the knowledge of concepts and skills from other disciplines (including science), and is the application of this knowledge to meet an identified need or to solve a problem using materials, energy, and tools (including computers). Technology also has an influence on processes and systems, on society, and on the ways people think, perceive, and define their world.

Grade 11 Chemistry emphasizes both the distinctions and relationships between science and technology. The following illustration shows how science and technology differ in purpose, procedure, and product, while at the same time relating to each other.

### Science and Technology: Their Nature and Interrelationships

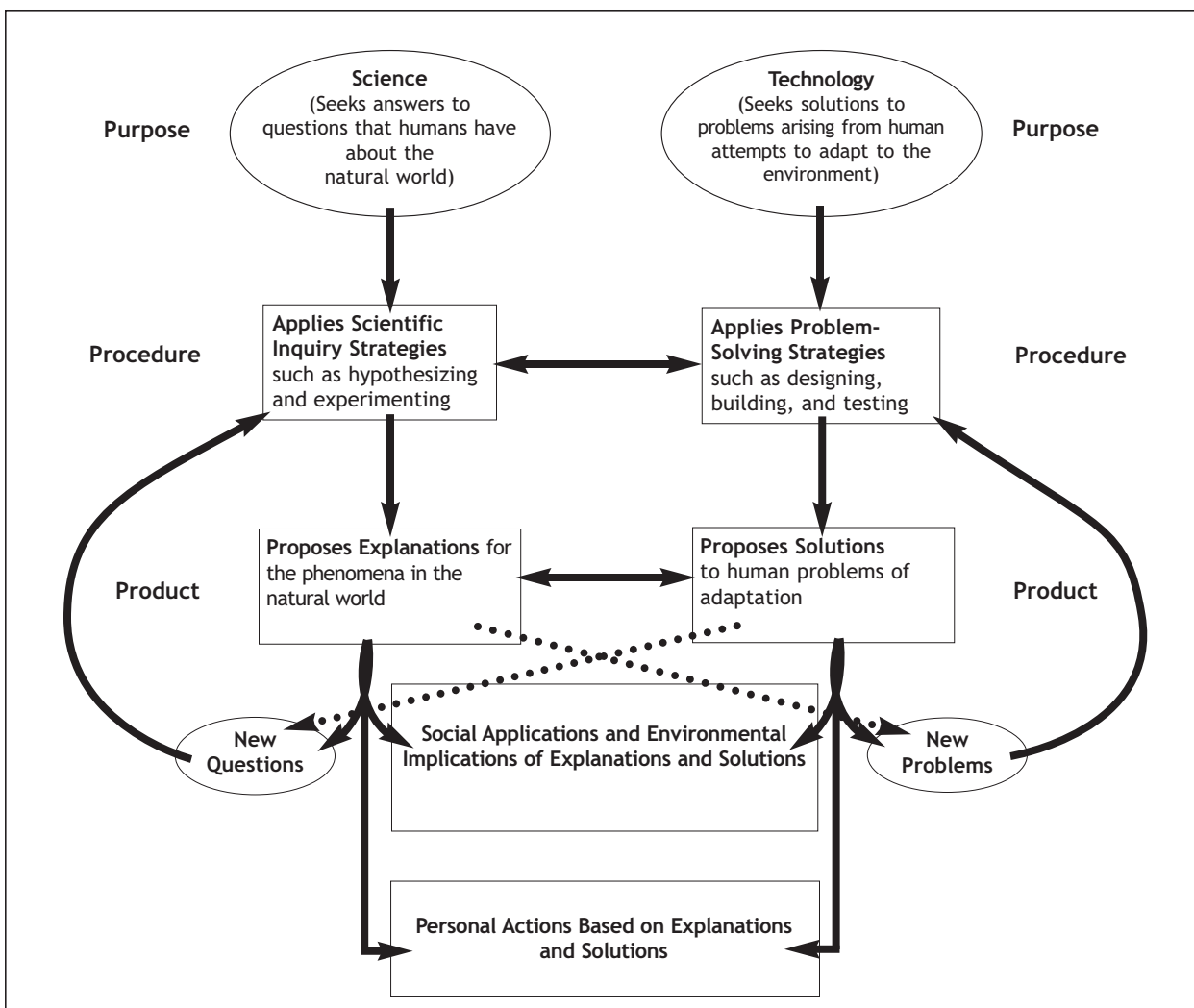

**Science and Technology: Their Nature and Interrelationships:** Adapted, with permission, from Rodger W. Bybee, *et al.*, *Science and Technology Education for the Elementary Years: Frameworks for Curriculum and Instruction* (Rawley, MA: The NETWORK, Inc., 1989).

The following general learning outcomes (GLOs) have been developed to define expectations related to the Nature of Science and Technology foundation area. (For a complete listing of the general and specific learning outcomes, see Appendix 11.)

---

### **Nature of Science and Technology General Learning Outcomes**

As a result of their Senior Years science education, students will:

- A1** Recognize both the power and limitations of science as a way of answering questions about the world and explaining natural phenomena.
  - A2** Recognize that scientific knowledge is based on evidence, models, and explanations, and evolves as new evidence appears and new conceptualizations develop.
  - A3** Distinguish critically between science and technology in terms of their respective contexts, goals, methods, products, and values.
  - A4** Identify and appreciate contributions made by women and men from many societies and cultural backgrounds that have increased our understanding of the world and brought about technological innovations.
  - A5** Recognize that science and technology interact with and advance one another.
- 

### **Science, Technology, Society, and the Environment (STSE)**

Understanding the complex interrelationships among science, technology, society, and the environment is an essential component of fostering increased scientific literacy. By studying the historical context, students come to appreciate ways in which cultural and intellectual traditions have influenced the questions and methodologies of science, and how science, in turn, has influenced the wider world of ideas.

Today, most scientists work in industry, where projects are more often driven by societal and environmental needs than by pure research. Many technological solutions have evoked complex social and environmental issues. Students recognize the potential of scientific literacy to inform and empower decision making of individuals, communities, and society as a whole.

Scientific knowledge is necessary, but not sufficient, for understanding the relationships among science, technology, society, and the environment. To understand these relationships fully, it is essential that students consider the values related to science, technology, society, and the environment.

### **Sustainable Development as a Decision-Making Model**

As a component of achieving scientific literacy, students must also develop an appreciation for the importance of sustainable development. Sustainable development is a decision-making model that considers the needs of both present and future generations, and integrates and balances the *health and well-being of the community, the environment, and the impact of economic activities*.

- *Sustainable human health and well-being* is characterized by people coexisting harmoniously within local, national, and global communities, and with nature. A sustainable society is one that is physically, psychologically, spiritually, and socially healthy. The well-being of individuals, families, and communities is of considerable importance.

- A *sustainable environment* is one in which the life-sustaining processes and natural resources of the Earth are conserved and regenerated.
- A *sustainable economy* is one that provides equitable access to resources and opportunities. It is characterized by development decisions, policies, and practices that respect cultural realities and differences, and do not exhaust the Earth's resources. A sustainable economy is evident when decisions, policies, and practices are carried out to minimize their impact on the Earth's resources and to maximize the regeneration of the natural environment.
- Decisions or changes related to any one of the three components – human health and well-being, the environment, or the economy – have a significant impact on the other two components and, consequently, on our *quality of life*. Decision making must take into account all three components to ensure an equitable, reasonable, and sustainable quality of life for all.

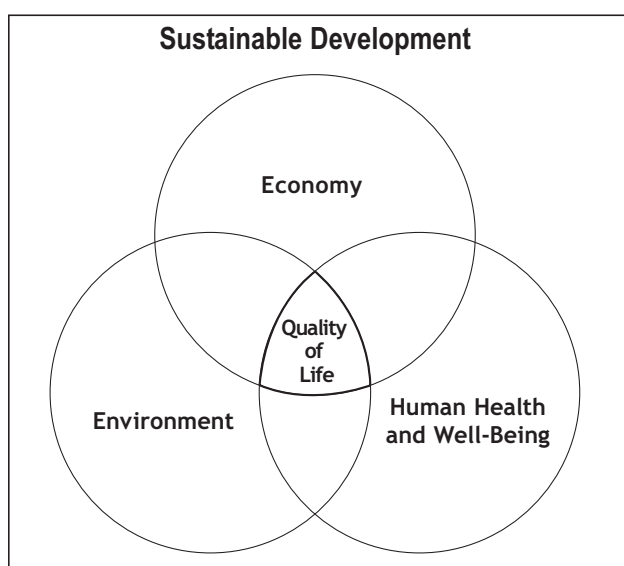

Educators are encouraged to consult *Education for a Sustainable Future* (Manitoba Education and Training), a document that outlines ways of incorporating precepts, principles, and practices to foster appropriate learning environments that would help direct students toward a sustainable future. The document is available online at <http://www.edu.gov.mb.ca/k12/docs/support/future>.

### **Sustainable Development, Social Responsibility, and Equity**

Sustainable development supports principles of social responsibility and equity. Williams believes that the concept of equity is essential to the attainment of sustainability. This includes equity among nations, within nations, between humans and other species, as well as between present and future generations.

Sustainable development is, at the same time, a decision-making process, a way of thinking, a philosophy, and an ethic. Compromise is an important idea that underlies the decision-making process within a sustainable development approach. In order to achieve the necessary balance among human health and well-being, the environment, and the economy, some compromises will be necessary.

There can be no greater contribution or more essential element to long-term environmental strategies leading to sustainable development that respects the environment... than the education of future generations in matters relating to the environment (UNESCO).

Public awareness and understanding of the concept of sustainable development and its practices are essential. If we are to change our way of life we must equip present and future generations with the knowledge and training to put sustainable development into effect (Manitoba Sustainability Development Coordination Unit 19).

As students advance from grade to grade, they identify STSE interrelationships and apply decision-making skills in increasingly demanding contexts, such as the following:

- **Complexity of understanding:** from simple, concrete ideas to abstract ideas; from limited knowledge of science to more in-depth and broader knowledge of science and the world
- **Applications in context:** from contexts that are local and personal to those that are societal and global
- **Consideration of variables and perspectives:** from one or two that are simple to many that are complex
- **Critical judgement:** from simple right or wrong assessments to complex evaluations
- **Decision making:** from decisions based on limited knowledge, made with the teacher's guidance, to decisions based on extensive research that are made independently and involve personal judgement

The following GLOs have been developed to define expectations related to the STSE foundation area.

---

### **Science, Technology, Society, and the Environment (STSE) General Learning Outcomes**

As a result of their Senior Years science education, students will:

- B1** Describe scientific and technological developments—past and present—and appreciate their impact on individuals, societies, and the environment, both locally and globally.
  - B2** Recognize that scientific and technological endeavours have been and continue to be influenced by human needs and the societal context of the time.
  - B3** Identify the factors that affect health, and explain the relationships among personal habits, lifestyle choices, and human health, both individual and social.
  - B4** Demonstrate a knowledge of and personal consideration for a range of possible science- and technology-related interests, hobbies, and careers.
  - B5** Identify and demonstrate actions that promote a sustainable environment, society, and economy, both locally and globally.
-

## Scientific and Technological Skills and Attitudes

A science education that strives for developing scientific literacy must engage students in answering questions, solving problems, and making decisions. These processes are referred to as scientific inquiry, technological problem solving (the design process), and decision making (see the following chart). While the skills and attitudes involved in these processes are not unique to science, they play an important role in the development of scientific understandings and in the application of science and technology to new situations.

<b>Processes for Science Education</b>			
	<b>Scientific Inquiry</b>	<b>Technological Problem Solving (Design Process)</b>	<b>Decision Making</b>
<b>Purpose:</b>	Satisfying curiosity about events and phenomena in the natural world.	Coping with everyday life, practices, and human needs.	Identifying different views or perspectives based on varying information.
<b>Procedure:</b>	What do we know? What do we want to know?	How can we do it? Will it work?	What are the alternatives or consequences? Which choice is best at this time?
<b>Product:</b>	Knowledge about events and phenomena in the natural world.	An effective and efficient way to accomplish a task or meet a need.	A defensible decision in a particular circumstance.

	<b>Scientific Question</b>	<b>Technological Problem</b>	<b>STSE Issue</b>
<b>Example:</b>	Why does my coffee cool so quickly?  <i>An Answer:</i> Heat energy is transferred by conduction, convection, and radiation to the surrounding environment.	How can I keep my coffee hot?  <i>A Solution:</i> A foam cup will keep liquids warm for a long time. So will an insulated cup.	Should we use foam cups or ceramic mugs for our meeting?  <i>A Decision:</i> Since we must use disposable cups for the meeting, we will choose a biodegradable type.

**Processes for Science Education:** Adapted with permission of the Minister of Education, Province of Alberta, Canada, 2006.

A description of each of these *processes* follows. *Attitudes*, which are an important element of each process, are also examined, and are treated as indicators along the pathway of student achievement. Hence, attitudes are to be modelled by teachers and students, but are not formally assessed in the same manner as other specific learning outcomes.



### Scientific Inquiry

Scientific inquiry is a way of learning about the universe. It involves posing questions and searching for explanations of phenomena. Although no single “scientific method” exists, students require certain skills to participate in science-related experiences using a variety of appropriate methods.

Skills such as questioning, observing, inferring, predicting, measuring, hypothesizing, classifying, designing experiments, and collecting, analyzing, and interpreting data are fundamental to scientific inquiry – as are attitudes such as curiosity, skepticism, and creativity. These skills are often represented as a cycle. This cycle involves posing questions, generating possible explanations, and collecting and analyzing evidence to determine which of these explanations is most useful and accurate in accounting for the phenomena under investigation. New questions may arise to reignite the cycle. It must be noted, however, that many scientific inquiries (past and present) do not necessarily follow a set sequence of steps, nor do they always start at the “beginning” of the cycle; scientists can be creative and responsive to scientific challenges as they arise.

### Technological Problem Solving

Technological problem solving seeks solutions to problems arising from human attempts to adapt to or change the environment. In Kindergarten to Grade 8 science, students have been developing these skills using a cycle of steps called the *design process*. This design process includes the proposing, creating, and testing of prototypes, products, and techniques in an attempt to reach an optimal solution to a given problem. Feedback and evaluation are built into this cycle. In Senior Years science, these technological problem-solving skills are incorporated into a *decision-making process*.

### STSE Issues and Decision Making

Students, as individuals and global citizens, are required to make decisions. Increasingly, the types of issues they face demand an ability to apply scientific and technological knowledge, processes, and products to the decisions they make related to STSE. The decision-making process involves a series of steps, which may include

- clarifying the issue
- critically evaluating all available research
- generating possible courses of action
- making a thoughtful decision
- examining the impact of the decision
- reflecting on the process

Students should be actively involved in decision-making situations as they progress through their science education. Not only are decision-making situations important in their own right, but they also provide a relevant context for engaging in scientific inquiry, problem solving, and the study of STSE relationships (as shown in the following illustration).

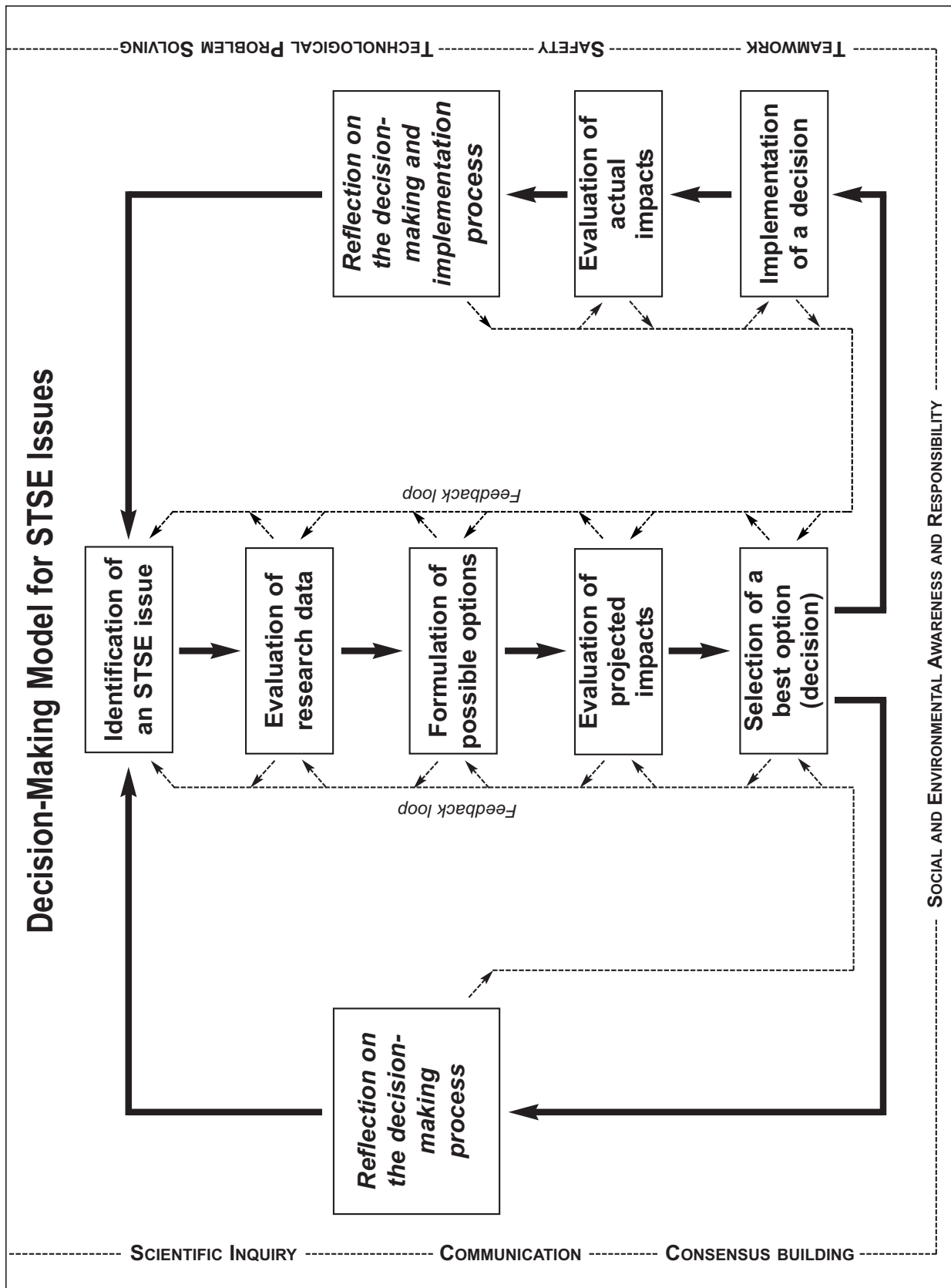

**Decision-Making Model for STSE Issues:** Reproduced from Introduction-12 of *Senior 2 Science: A Foundation for Implementation*. Copyright © 2003 by Manitoba Education and Youth.

## Attitudes

Attitudes refer to generalized aspects of behaviour that are modelled for students. Attitudes are not acquired in the same way as skills and knowledge. They cannot be observed at any particular moment, but are evidenced by regular, unprompted manifestations over time. Development of attitudes is a lifelong process that involves the home, the school, the community, and society at large. The development of positive attitudes plays an important role in students' growth, affecting their intellectual development and creating a readiness for responsible application of what they learn.

The following GLOs have been developed to define expectations related to the Scientific and Technological Skills and Attitudes foundation area.

---

## Scientific and Technological Skills and Attitudes General Learning Outcomes

As a result of their Senior Years science education, students will:

- C1** Recognize safety symbols and practices related to scientific and technological activities and to their daily lives, and apply this knowledge in appropriate situations.
- C2** Demonstrate appropriate scientific inquiry skills when seeking answers to questions.
- C3** Demonstrate appropriate problem-solving skills when seeking solutions to technological challenges.
- C4** Demonstrate appropriate critical thinking and decision-making skills when choosing a course of action based on scientific and technological information.
- C5** Demonstrate curiosity, skepticism, creativity, open-mindedness, accuracy, precision, honesty, and persistence, and appreciate their importance as scientific and technological habits of mind.
- C6** Employ effective communication skills and use information technology to gather and share scientific and technological ideas and data.
- C7** Work cooperatively and value the ideas and contributions of others while carrying out scientific and technological activities.
- C8** Evaluate, from a scientific perspective, information and ideas encountered during investigations and in daily life.

---

## Essential Science Knowledge

The subject matter of science includes theories, models, concepts, and principles that are essential to an understanding of life sciences, physical sciences, and Earth and space sciences. Content is a vehicle for essential learnings (Drake), and it will be increasingly important for students of chemistry to make interdisciplinary connections among the following.

- **Life sciences:** This study deals with the growth and interactions of life forms within their environment in ways that reflect their uniqueness, diversity, genetic continuity, and changing nature. Life sciences include the study of organisms (including humans and cells), ecosystems, biodiversity, biochemistry, and biotechnology.

- **Physical sciences:** Primarily associated with chemistry and physics, the physical sciences deal with matter, energy, and forces. Matter has structure, and interactions exist among its components. Energy links matter to gravitational, electromagnetic, and nuclear forces of the universe. The laws of conservation of mass and energy, momentum, and charge are addressed by physical science.
- **Geosciences and the space sciences:** These studies provide students with local, global, and universal perspectives. Earth exhibits form, structure, and patterns of change, as does our surrounding solar system and the physical universe beyond. Earth and space sciences include fields of study such as geology, hydrology, meteorology, and astronomy.

The following GLOs have been developed to define expectations related to the Essential Science Knowledge foundation area.

---

### Essential Science Knowledge General Learning Outcomes

As a result of their Senior Years science education, students will:

- D1** Understand essential life structures and processes pertaining to a wide variety of organisms, including humans.
- D2** Understand various biotic and abiotic components of ecosystems, as well as their interaction and interdependence within ecosystems and within the biosphere as a whole.
- D3** Understand the properties and structures of matter, as well as various common manifestations and applications of the actions and interactions of matter.
- D4** Understand how stability, motion, forces, and energy transfers and transformations play a role in a wide range of natural and constructed contexts.
- D5** Understand the composition of the Earth's atmosphere, hydrosphere, and lithosphere, as well as the processes involved within and among them.
- D6** Understand the composition of the universe, the interactions within it, and the implications of humankind's continued attempts to understand and explore it.

---

### The Unifying Concepts

An effective way to create linkages within and among science disciplines is to use unifying concepts—the key ideas that underlie and integrate all science knowledge and extend into areas such as mathematics and social studies. Unifying concepts help students construct a more holistic, systems-related understanding of science and its role in society.

The following four unifying concepts were used in the development of Grade 11 Chemistry:

- **Similarity and diversity:** The concepts of similarity and diversity provide tools for organizing our experiences with the world. Beginning with informal experiences, students learn to recognize attributes of materials, organisms, and events that help to make useful distinctions between and among them. Over time, students adopt accepted procedures and protocols for describing and classifying objects, organisms, and events they encounter, thus enabling them to share ideas with others and to reflect on their own experiences.

- **Systems and interactions:** An important part of understanding and interpreting the world is the ability to think about the whole in terms of its parts and, alternately, about parts in terms of how they relate to one another and to the whole. A system is a collection of components that interact with one another so that the overall effect is often different from that of the individual parts, even when these are considered together. Students will study both natural and technological systems.
- **Change, constancy, and equilibrium:** The concepts of constancy and change underlie most understandings of the natural and technological world. Through observations, students learn that some characteristics of living things, materials, and systems remain constant over time, whereas others change. Through formal and informal studies, students develop an understanding of the processes and conditions in which change, constancy, and equilibrium take place.
- **Energy:** The concept of energy provides a conceptual understanding that brings together many aspects of natural phenomena, materials, and the processes of change. Energy, whether transmitted or transformed, is the driving force of both movement and change. Students learn to describe energy in terms of its effects and, over time, develop a concept of energy as something inherent within the interactions of materials, the processes of life, and the functions of systems.

The following GLOs have been developed to define expectations related to the Unifying Concepts foundation area.

---

### **Unifying Concepts General Learning Outcomes**

As a result of their Senior Years science education, students will:

- E1** Describe and appreciate the similarity and diversity of forms, functions, and patterns within the natural and constructed world.
  - E2** Describe and appreciate how the natural and constructed world is made up of systems and how interactions take place within and among these systems.
  - E3** Recognize that characteristics of materials and systems can remain constant or change over time, and describe the conditions and processes involved.
  - E4** Recognize that energy, whether transmitted or transformed, is the driving force of both movement and change, and is inherent within materials and in the interactions among them.
-

## Kindergarten to Grade 10 Science Topic Chart

The following table provides a quick reference to the different thematic clusters from Kindergarten to Grade 10 Science. It allows teachers to examine, at a glance, students' previous exposure to scientific knowledge in different areas. The chemistry-related content clusters are grey-shaded for reference.

	Cluster 0	Cluster 1	Cluster 2	Cluster 3	Cluster 4
Kindergarten	Overall Skills and Attitudes (To Be Integrated into Clusters 1 to 4)	Trees	Colours	Paper	---
Grade 1		Characteristics and Needs of Living Things	The Senses	Characteristics of Objects and Materials	Daily and Seasonal Changes
Grade 2		Growth and Changes in Animals	Properties of Solids, Liquids, and Gases	Position and Motion	Air and Water in the Environment
Grade 3		Growth and Changes in Plants	Materials and Structures	Forces That Attract or Repel	Soils in the Environment
Grade 4		Habitats and Communities	Light	Sound	Rocks, Minerals, and Erosion
Grade 5		Maintaining a Healthy Body	Properties of and Changes in Substances	Forces and Simple Machines	Weather
Grade 6		Diversity of Living Things	Flight	Electricity	Exploring the Solar System
Grade 7		Interactions within Ecosystems	Particle Theory of Matter	Forces and Structures	Earth's Crust
Grade 8		Cells and Systems	Optics	Fluids	Water Systems
Grade 9		Reproduction	Atoms and Elements	Nature of Electricity	Exploring the Universe
Grade 10		Dynamics of Ecosystems	Chemistry in Action	In Motion	Weather Dynamics

## NOTES

## SECTION 2:

# IMPLEMENTATION OF GRADE 11 CHEMISTRY

---

The Senior Years Student and the Science Learning Environment	3
Effective Teaching in Chemistry: What the Research Says to Teachers	14
Unit Development in Chemistry	17
A View of Chemistry Education: Toward Modes of Representation	18
The Modes of Representation	18
Toward an Instructional Philosophy in Chemistry	25





# IMPLEMENTATION OF GRADE 11 CHEMISTRY

## The Senior Years Student and the Science Learning Environment

Each year, teachers are called upon to make a myriad of decisions regarding course content, learning materials and resources, and instructional and assessment methods. Successful learning is more likely to occur if these decisions are informed by teachers' understanding of their students and the ways they learn.

Teachers seeking to learn about their students need to be knowledgeable in various areas, including the following:

- **How people learn:** In recent decades, cognitive psychology, brain-imaging technology, and multiple intelligences theory have transformed our understanding of learning. Ongoing professional learning is important to teachers as they seek to update their knowledge of the processes of learning.
- **Ways in which student populations are changing:** The students whom teachers encounter today are different in many respects from students a generation ago. Students are more likely to be living with a single parent or stepfamily. More have part-time jobs. Students are more sophisticated in their knowledge and use of information technology, and much of their understanding of the world comes from television. Classrooms are more likely to be ethnically diverse.
- **Developmental characteristics of students:** The characteristics of adolescent learners have many implications for teachers.
- **The unique qualities of each student:** Family relationships, academic and life experiences, personality, interests, learning approaches, socio-economic status, and rate of development all influence a student's ability to learn. Teachers can gain an understanding of the unique qualities of each student only through daily interaction, observation, and assessment.

## Characteristics of Grade 11 Learners

For many students, Grade 11 is a stable and productive year. Many Grade 11 students have developed a degree of security within their peer group and a sense of belonging in school. They show increasing maturity in dealing with the freedoms and responsibilities of late adolescence: romantic relationships, part-time jobs, and a driver's licence. In Grade 11, most students have a great deal of energy and a growing capacity for abstract and critical thinking. Many are prepared to express themselves with confidence and to take creative and intellectual risks. The stresses and preoccupations of preparing for graduation, post-secondary education, or full-time jobs are still a year away. For many students, Grade 11 may be the most profitable academic year of the Senior Years.

---

**Characteristics of Grade 11 Learners:** Adapted from Section 1-4 and 1-5 of *Senior 3 English Language Arts: A Foundation for Implementation*. Copyright © 1999 by Manitoba Education and Training.

Although many Grade 11 students handle their new responsibilities and the demands on their time with ease, others experience difficulty. External interests may seem more important than school. Because of their increased autonomy, students who previously had problems managing their behaviour at school may now express their difficulties through poor attendance, alcohol and drug use, or other behaviours that place them at risk.

Students struggling to control their lives and circumstances may make choices that seem to teachers to be contrary to their best interests. Communication with the home and awareness of what their students are experiencing outside school continue to be important for Grade 11 teachers. Although the developmental variance evident in previous years has narrowed, students in Grade 11 can still change a great deal in the course of one year or even one semester. Teachers need to be sensitive to the dynamic classroom atmosphere and recognize when shifts in interests, capabilities, and needs are occurring, so they can adjust learning experiences for their students.

The following chart identifies some common characteristics of late adolescence observed in educational studies (Glatthorn; Maxwell and Meiser; Probst) and by Manitoba teachers, and discusses the implications of these characteristics for teachers.

<b>Grade 11 Learners: Implications for Teachers</b>	
<b>Characteristics of Grade 11 Learners</b>	<b>Significance for Grade 11 Teachers</b>
<b>Cognitive Characteristics</b>	
<ul style="list-style-type: none"> <li>• Most Grade 11 learners are capable of abstract thought and are in the process of revising their former concrete thinking into fuller understanding of principles.</li> <li>• Students are less absolute in their reasoning, more able to consider diverse points of view. They recognize that knowledge may be relative to context.</li> <li>• Many basic learning processes have become automatic by Grade 11, freeing students to concentrate on complex learning.</li> <li>• Students have a clearer self-understanding and have developed specialized interests and expertise. They need to connect what they are learning to the world outside the school. Chemistry must be seen as valuable and necessary.</li> </ul>	<ul style="list-style-type: none"> <li>• Teach to the big picture. Help students forge links between what they already know and what they are learning. Be cognizant of individual differences and build bridges for students who think concretely.</li> <li>• Focus on developing problem-solving and critical thinking skills, particularly those related to STSE and decision making.</li> <li>• Identify the knowledge, skills, and strategies that students already possess, and build the course around new challenges. Through assessment, identify students who have not mastered learning processes at Grade 11 levels and provide additional assistance and support.</li> <li>• Use strategies that enhance students' metacognition. Encourage students to develop scientific skills through exploring areas of interest. Cultivate classroom experts and invite students with individual interests to enrich the learning experience of the class.</li> </ul>

*(continued)*

**Grade 11 Learners: Implications for Teachers:** Adapted from Section 1-5 to 1-7 of *Senior 3 English Language Arts: A Foundation for Implementation*. Copyright © 1999 by Manitoba Education and Training.

<b>Grade 11 Learners: Implications for Teachers (continued)</b>	
<b>Characteristics of Grade 11 Learners</b>	<b>Significance for Grade 11 Teachers</b>
<b>Psychological and Emotional Characteristics</b>	
<ul style="list-style-type: none"> <li>• It is important for Grade 11 students to see that their autonomy and emerging independence are respected. They need a measure of control over what happens to them in school.</li> <li>• Students are preparing for senior leadership roles within the school and may be more involved with leadership in their communities.</li> <li>• Students need to understand the purpose and relevance of practices, policies, and processes. They may express their growing independence through a general cynicism about authority and institutions.</li> <li>• Grade 11 students have a clearer sense of identity than they had previously and are capable of being more reflective and self-aware. Some students are more willing to express themselves and disclose their thoughts and ideas.</li> </ul>	<ul style="list-style-type: none"> <li>• Provide choice. Allow students to select many of the resources they will explore and the forms they will use to demonstrate their learning. Collaborate with students in assessment. Teach students to be independent learners. Gradually release responsibility to students.</li> <li>• Provide students with leadership opportunities within the classroom and with a forum to practise skills in public speaking and group facilitation.</li> <li>• Use students' tendency to question social mores to help them develop critical thinking. Negotiate policies and demonstrate a willingness to make compromises. Use students' questions to fuel classroom inquiry.</li> <li>• Provide optional and gradual opportunities for self-disclosure. Invite students to explore and express themselves through their work. Celebrate student differences.</li> </ul>
<b>Physical Characteristics</b>	
<ul style="list-style-type: none"> <li>• Many Grade 11 students have reached adult physical stature. Others, particularly males, are still in a stage of extremely rapid growth and experience a changing body image and self-consciousness.</li> <li>• By Grade 11, students are better able to sit still and concentrate on one learning task for longer periods, but they still need interaction and variety. They have a great deal of energy.</li> <li>• Grade 11 students still need more sleep than adults do, and may come to school tired as a result of part-time jobs or activity overload.</li> </ul>	<ul style="list-style-type: none"> <li>• Be sensitive to the risk students may feel in public performances and increase expectations gradually. Provide students with positive information about themselves.</li> <li>• Put physical energy to the service of active learning instead of trying to contain it. Provide variety; change the pace frequently; use kinesthetic learning experiences.</li> <li>• Be aware that inertia or indifference may be the result of fatigue. Work with students and families to set goals and plan activities realistically so that school work assumes a higher priority.</li> </ul>

*(continued)*

<b>Grade 11 Learners: Implications for Teachers (continued)</b>	
<b>Characteristics of Grade 11 Learners</b>	<b>Significance for Grade 11 Teachers</b>
<b>Moral and Ethical Characteristics</b>	
<ul style="list-style-type: none"> <li>• Grade 11 students are working at developing a personal ethic, rather than following a prescribed set of values and code of behaviour.</li> <li>• Students are sensitive to personal or systemic injustice but are increasingly realistic about the factors affecting social change.</li> <li>• Students are shifting from an egocentric view of the world to one centred in relationships and community. They are able to recognize different points of view and adapt to difficult situations.</li> <li>• Students are becoming realistic about the complexities of adult responsibilities but resist arbitrary authority.</li> </ul>	<ul style="list-style-type: none"> <li>• Explore the ethical meaning of situations in life and in scientific contexts. Provide opportunities for students to reflect on their thoughts in discussion, writing, or representation.</li> <li>• Explore ways in which decision-making activities can effect social change, and link to the continuum of science, technology, society, and the environment.</li> <li>• Provide opportunities for students to make and follow through on commitments and to refine their interactive skills.</li> <li>• Explain the purpose of every learning experience. Enlist student collaboration in developing classroom policies. Strive to be consistent.</li> </ul>
<b>Social Characteristics</b>	
<ul style="list-style-type: none"> <li>• By Grade 11, certain individuals will take risks in asserting an individual identity. Many students, however, continue to be intensely concerned with how peers view their appearance and behaviour. Much of their sense of self is drawn from peers, with whom they may adopt a “group consciousness,” rather than from making autonomous decisions.</li> <li>• Adolescents frequently express identification with peer groups through slang, musical choices, clothing, body decoration, and behaviour.</li> <li>• Crises of friendship and romance, and a preoccupation with relationships, can distract students from academics.</li> <li>• Students begin to recognize teachers as individuals and welcome a personal connection.</li> </ul>	<ul style="list-style-type: none"> <li>• Ensure that the classroom has an accepting climate. Model respect for each student. Use learning experiences that foster student self-understanding and self-reflection. Challenge students to make personal judgements about situations in life and in their natural environment.</li> <li>• Foster a classroom identity and culture. Ensure that every student is included and valued. Structure learning so that students can interact with peers, and teach strategies for effective interaction.</li> <li>• Open doors for students to study personal relationships in science (for example, through biographies of scientists). Respect confidentiality, except where a student’s safety is at risk.</li> <li>• Nurture and enjoy a relationship with each student. Try to find areas of common interest with each one. Respond with openness, empathy, and warmth.</li> </ul>

### Fostering a Will to Learn: Creating Links between Language and Science

Experiences of intense involvement are optimal opportunities to teach engagement in learning, and teachers should try to ensure they happen frequently in the classroom. Not every learning task, however, can be intrinsically rewarding to every learner. Being a successful learner also requires a high degree of what Corno and Randi call “sustained voluntary effort” – an attitude expressed in committing oneself to less interesting tasks, persisting in solving problems, paying conscientious attention to detail, managing time, self-monitoring, and making choices between competing values, such as the desire to do well on a homework assignment and the desire to spend the evening with friends. The willingness to make this sustained effort constitutes motivation.

Motivation is a concern of teachers, not only because it is essential to classroom learning, but also because volition and self-direction are central to lifelong learning. Science courses seek to teach students how to interpret and analyze science concepts, and to foster the desire to do so. Motivation is not a single factor that students either bring or do not bring to the classroom. It is multi-dimensional, individual, and often comprises both intrinsic and extrinsic elements. Students hold certain presuppositions about science learning that affect the way they learn. Teachers can promote certain attitudes and skills to facilitate students’ engagement in each learning task, while recognizing and affirming entry-level abilities.

In considering how they can foster motivation, teachers may explore students’ appreciation of the value (intrinsic and extrinsic) of learning experiences and their belief about their likelihood of success. Good and Brophy suggest that these two elements can be expressed as an equation; the effort students are willing to expend on a task is a product of their expectation of success and of the value they ascribe to success.

<b>Expectancy</b> (the degree to which students expect to be able to perform the tasks successfully if they apply themselves)	<b>x</b>	<b>Value</b> (the degree to which students value the rewards of performing a task successfully)	<b>=</b>	<b>Motivation</b>
--	----------	--	----------	-------------------

Teachers may, therefore, want to focus on ensuring that students are able to succeed if they apply reasonable effort, and on helping students recognize the value of classroom learning experiences. The following chart provides teachers with suggestions for fostering motivation.

---

**Fostering a Will to Learn:** Adapted from Section 1-8 of *Senior 3 English Language Arts: A Foundation for Implementation*. Copyright © 1999 by Manitoba Education and Training.

<b>Fostering Motivation</b>	
<b>Ways to Foster Expectations of Success</b>	<b>Best Practice and Research</b>
<ul style="list-style-type: none"> <li>• Help students to develop a sense of self-efficacy.</li> </ul>	<ul style="list-style-type: none"> <li>• Schunk and Zimmerman found that students who have a sense of self-efficacy are more willing to participate, work harder, persist longer when they encounter difficulties, and achieve at a higher level than students who doubt their learning capabilities.</li> <li>• Teachers foster student self-efficacy by recognizing that each student can succeed and by communicating that belief to the student. Silver and Marshall found that a student's perception that he or she is a poor learner is a strong predictor of poor performance, overriding natural ability and previous learning. All students benefit from knowing that the teacher believes they can succeed and will provide the necessary supports to ensure that learning takes place.</li> <li>• Teachers also foster a sense of self-efficacy by teaching students that they can learn how to learn. Students who experience difficulty often view the learning process as mysterious and outside their control. They believe that others who succeed in school do so entirely because of natural, superior abilities. It is highly motivating for these students to discover that they, too, can learn and apply the strategies that successful students use when learning.</li> </ul>
<ul style="list-style-type: none"> <li>• Help students to learn about and monitor their own learning processes.</li> </ul>	<ul style="list-style-type: none"> <li>• Research shows that students with high metacognition (students who understand how they learn) learn more efficiently, are more adept at transferring what they know to other situations, and are more autonomous than students who have little awareness of how they learn. Teachers enhance metacognition by embedding, into all aspects of the curriculum, instruction in the importance of planning, monitoring, and self-assessing. Turner found that teachers foster a will to learn when they support "the cognitive curriculum with a metacognitive and motivational one" (199).</li> </ul>
<ul style="list-style-type: none"> <li>• Assign tasks of appropriate difficulty, communicating assessment criteria clearly and ensuring that students have clear instruction, modelling, and practice so they can complete the tasks successfully.</li> </ul>	<ul style="list-style-type: none"> <li>• Ellis <i>et al.</i> found that systemic instruction helps students to learn strategies they can apply independently.</li> </ul>
<ul style="list-style-type: none"> <li>• Help students to set specific and realistic personal goals and to learn from situations where they do not attain their goals. Celebrate student achievements.</li> </ul>	<ul style="list-style-type: none"> <li>• Research shows that learning is enhanced when students set goals that incorporate specific criteria and performance standards (Foster; Locke and Latham).</li> <li>• Teachers promote goal-setting skills by working in collaboration with students in developing assessment strategies and rubrics (see Section 3: Assessment in Grade 11 Chemistry and Appendix 9).</li> </ul>

(continued)

**Fostering Motivation:** Adapted from Section 1-9 to 1-10 of *Senior 3 English Language Arts: A Foundation for Implementation*. Copyright © 1999 by Manitoba Education and Training.

<b>Fostering Motivation (continued)</b>	
<b>Ways to Foster Expectations of Success</b>	<b>Best Practice and Research</b>
<ul style="list-style-type: none"> <li>• Offer choices</li> </ul>	<ul style="list-style-type: none"> <li>• Intrinsic motivation is closely tied to students' self-selection of topics, texts, learning activities, and creative forms. Teachers may involve students in the choice of a topic for thematic development. Support students in the search for learning resources that are developmentally appropriate and of high interest, and encourage students to bring the world views they value into the classroom. Self-selection allows students to build their learning on the foundation of their personal interests and enthusiasm.</li> </ul>
<ul style="list-style-type: none"> <li>• Set worthwhile academic objectives.</li> </ul>	<ul style="list-style-type: none"> <li>• Rather than asking students to execute isolated skills or perform exercises that are without context, embed instruction in meaningful events and activities that simulate real-world settings, and ensure that students share performances and products with a peer audience.</li> </ul>
<ul style="list-style-type: none"> <li>• Help students to learn about and monitor their own learning processes.</li> </ul>	<ul style="list-style-type: none"> <li>• In teaching specific learning strategies, focus on the usefulness of each strategy for making information meaningful, or for expressing ideas of importance to students. Emphasize the importance of science to the richness and effectiveness of students' lives, and de-emphasize external rewards and consequences such as marks.</li> </ul>
<ul style="list-style-type: none"> <li>• Ensure that scientific experiences are interactive.</li> </ul>	<ul style="list-style-type: none"> <li>• A community that encourages students to share their learning with each other values science. Teachers who model curiosity, enthusiasm, and pleasure in learning science-related concepts, and who share their experiences, foster motivation for scientific literacy.</li> </ul>

### **Creating a Stimulating Learning Environment**

A vital science class grows out of, and is reflected in, a stimulating and inviting physical environment. While the resources and physical realities of classrooms vary, a well-equipped science classroom offers or contains a variety of resources that help stimulate learning. It is helpful to involve students in the classroom design.

Ways to create a stimulating learning environment include the following:

- **Flexible seating arrangements:** Use movable desks or tables to design seating arrangements that reflect a student-centred philosophy and that allow students to interact in various configurations.
- **A media-rich environment:** Have a classroom library of books for self-selected reading. The classroom library may include science periodicals, newspaper articles, newsletters, Internet articles, science-fiction literature, and students' published work. It may also include a binder of student reviews and recommendations, and may be decorated by student-designed posters or book jackets. Classroom reference materials could include dictionaries/encyclopedias of science, books of facts, software and CD-ROM titles, past examinations collated into binders, and manuals.
- **Access to electronic equipment:** Provide access to a computer, television, videocassette recorder, DVD-ROM, and video camera, if possible.



- **Wall displays:** Exhibit posters, Hall of Fame displays, murals, banners, and collages that celebrate student accomplishments. Change these regularly to reflect student interests and active involvement in the science classroom.
- **Display items and artifacts:** Have models, plants, photographs, art reproductions, maps, newspaper and magazine clippings, fossils, musical instruments, and so on, in your classroom to stimulate inquiry and to express the link between the science classroom and the larger world.
- **Communication:** Post checklists, processes, and strategies to facilitate and encourage students' independent learning. Provide a bulletin board for administrative announcements and schedules.
- **Well-equipped and safe laboratory:** Provide regular access to a well-equipped and safe science lab to foster the development of critical lab skills.

### Language Learning Connected to Science

Science curricula involve all aspects of language and literacy development. Halliday suggests that as students actively use the language arts, they engage in three kinds of language learning, which can be linked to broader scientific literacy (cited in Strickland and Strickland 203).

- **Students learn language:** Language learning is a social process that begins at infancy and continues throughout life. Language-rich environments enhance and accelerate the process. Terminology-rich science has a role in new language development.
- **Students learn through language:** As students listen, read, or view, they focus primarily on making meaning from the text at hand. Students use language to increase their knowledge of the world.
- **Students learn about language:** Knowledge of language and how it works is a subject in and of itself; nevertheless, science as a discipline of inquiry relies on a particular use of language for effective communication. Consequently, students also focus on the language arts and their role when applied to science.

Scientific literacy learning is dynamic and involves many processes. The following graphic identifies some of the dynamic processes that form the foundation for effective literacy learning in science classrooms.

## Dynamic Processes in Literacy Learning Integrated into Science

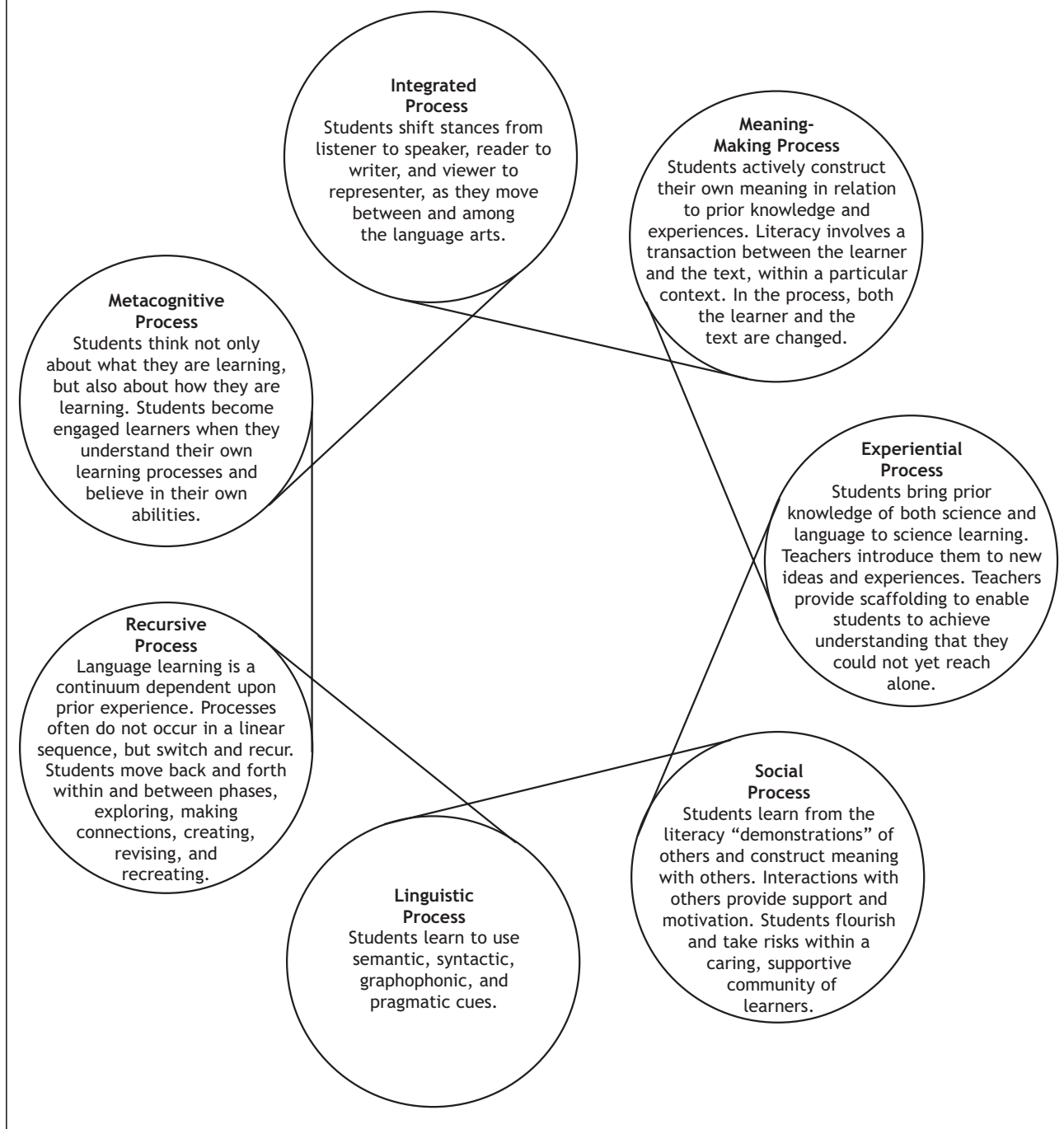

**Dynamic Processes in Literacy Learning Integrated into Science:** Adapted from Overview-11 of *Senior 2 English Language Arts: A Foundation for Implementation*. Copyright © 1998 by Manitoba Education and Training.

### **Ethical Issues**

The development of topics within Grade 11 Chemistry should lead to issues and questions that go beyond the traditional curriculum. For example, medical biochemistry, or the implementation of international protocols related to the prospects of global climate change, raises questions of ethics, values, and responsible use of the products of the physical sciences. The environmental consequences of the industrial applications of chemistry, or the atmospheric chemistry of climate change, raise issues of considerable importance, as do the topics of nuclear waste disposal and weapons procurement. These are among the important issues that science is often called upon for advice. As students and teachers address these issues, they will naturally be drawn to the study of the underlying scientific concepts. Students should realize that science only provides the background for making informed personal and social decisions, and that, as informed decision makers, they may have an impact on society and the world. Students of chemistry are not immune to the importance of these aspects of science in a modern, post-industrial world.

Some students and parent(s) may express concern because the perspectives of current science conflict with personal systems of belief. These individuals have a right to expect that science and the public education system will respect those beliefs, although this does not preclude such issues from arising in the classroom. Teachers should explain to students that science is one way of learning about the universe and our unique place embedded in it, and that other explanations, in addition to those of the traditional Western sciences, have been put forth—particularly in the realm of cosmogony.

### **Diversity in the Classroom**

Students come from a variety of backgrounds and have distinct learning requirements, learning and thinking approaches, and prior knowledge and experiences. Their depth of prior knowledge varies, reflecting their experiences inside and outside the classroom. Some entry-level knowledge held by students may be limited or incorrect, impeding new learning. For new learning to occur, it is important for teachers to activate students' prior knowledge, to correct misconceptions, and to encourage students to relate new information to prior experiences.

Manitoba's cultural diversity provides opportunities for embracing a wealth of culturally significant references and learning resources in the Senior Years science classroom. Students from various backgrounds bring socially constructed meanings, references, and values to science learning experiences, as well as their unique learning approaches. As noted in *Senior Years Science Teachers' Handbook*, "To be effective, the classroom must reflect, accommodate, and embrace the cultural diversity of its students" (Manitoba Education and Training 7.13).

In addition, cultural influences can affect how students think about science: reasoning by analogy or by strict linear logic; memorization of specific correct responses or generalizations; problem solving by induction or by deduction; or needing to learn through hands-on apprenticeship to gain one aspect of a skill before moving on to the next step (Kolodny). Cultural prohibitions permeate some societies; for example, values that discourage assertiveness, outspokenness, and competitiveness in some cultures can result in behaviour that can be interpreted as being indifferent, having nothing to say, or being unable to act decisively (Hoy; National Research Council). The problems engendered by these cultural differences are often beyond the ability of teachers of advanced courses to handle on their own. In many such cases, support from other members of the school staff is essential.

### **Learning Resources**

Traditionally, the teaching of science in Senior Years has largely been a textbook-centred enterprise. The use of a single textbook as the sole resource for the teaching and learning of science severely restricts the development of knowledge, skills and strategies, and attitudes that are critical for today's students. Furthermore, it promotes the idea that all answers are enshrined in a textbook. The successful implementation of Grade 11 Chemistry depends on a resource-based learning approach, in which textbooks are used only as one of many reference sources. Research suggests that we should provide a wide range of learning resources for structuring teaching and learning experiences. These include human resources, textbooks, magazines/journals, films, audio and video recordings, computer-based multimedia resources, the Internet, and other materials.

Resources referenced in this curriculum include print reference materials such as *Senior Years Science Teachers' Handbook: A Teaching Resource* (Manitoba Education and Training) and *Science Safety: A Kindergarten to Senior 4 Resource Manual for Teachers, Schools, and School Divisions* (Manitoba Education and Training). In addition, numerous articles from the chemistry education research community are recommended to teachers.

The choice of learning resources, such as text(s), multimedia learning resources (including video, software, CD-ROMs, microcomputer-based laboratory [MBL] probeware, calculator-based laboratory [CBL] probeware), and websites, will depend on the topic, the local situation, the reading level of students, the background of the teacher, community resources, and availability of other materials. A concerted effort should be made to use appropriate learning resources from a wide variety of sources, as not all curricular outcomes can be achieved by using any one resource in the study of a particular topic.

---

### **Selecting Learning Resources**

For information on selecting learning resources for Grade 11 and Grade 12 Chemistry, see the Manitoba Education, Citizenship and Youth website at: <<http://www.edu.gov.mb.ca/k12/learnres/bibliographies.html>>.

---

## Implementing the Curriculum

Chemistry curricula in the past have focused primarily on presenting a breadth of knowledge (that is, a large amount of content) deemed essential, and on the mathematical manipulation of algorithms. While the Grade 11 Chemistry curriculum continues to be concerned with students gaining relevant knowledge and with providing appropriate mathematical treatment of concepts, it is also concerned both with fostering the development of various skills (context-based process skills, decision-making skills, problem-solving skills, laboratory experimental skills, critical thinking skills, independent learning skills) and with effecting a change of viewpoint. A strong focus of Grade 11 Chemistry is to link science to the experiential life of students.

By offering a multidisciplinary focus where appropriate, Grade 11 Chemistry provides a new set of foundations for fostering increased scientific literacy. Consisting of 28 general learning outcomes (GLOs), each linked with a number of specific learning outcomes (SLOs), the Grade 11 Chemistry curriculum will build upon what students know and are able to do as a result of their studies in Kindergarten to Grade 10 Science (see Kindergarten to Grade 10 Science Topic Chart at the end of Section 1: Manitoba Foundations for Scientific Literacy).

Grade 11 Chemistry assumes *110 hours* of instructional time, and is designed to include formal assessments, field excursions, and related co-curricular efforts.

## Effective Teaching in Chemistry: What the Research Says to Teachers

### Findings of Research on How Students Learn

A number of summaries of the instructional implications of recent research on learning are provided below. The National Research Council report *How People Learn: Brain, Mind, Experience, and School: Expanded Edition* (Bransford, Brown, and Cocking) can be adapted and elaborated specifically for the study of chemistry. That report leads to the following implications for effective chemistry instruction.

- 1. Effective teachers draw out and work with students' current understandings, including those understandings students bring with them to the course and those they develop as the course progresses.**

There is an emerging consensus in science education research, including a substantial body of work specific to introductory chemistry, that, to be effective, instruction must elicit, engage, and respond substantively to student understandings (Champagne, Gunstone, and Klopfer; Clement; Hake; Hestenes, Wells, and Swackhamer; McDermott and Redish). There are now a number of examples of curricula and materials designed to support interaction with students' prior understandings, and there is evidence that these approaches can achieve progress in understanding that is not possible for most students with traditional methods.

**2. Effective teachers address students' metacognitive skills, habits, and epistemologies.**

Students need to understand not only the concepts of chemistry, but also the nature of knowledge and learning (Hammer; Hewson; McDermott; Reif and Larkin; White and Frederiksen). Many students arrive at chemistry courses, including advanced-treatment courses such as Chemistry Advanced Placement (AP), expecting to learn by memorizing formulas disconnected from each other, as well as from the students' experiences of the physical world. Effective instruction challenges these expectations, helping students to see chemistry learning as a matter of identifying, applying, and refining their current understanding. Students learn to examine assumptions hidden in their reasoning; to monitor the quality and consistency of their understanding; to formulate, implement, critique, and refine models of physical phenomena; and to make use of a spectrum of appropriate representational tools. By the end of a chemistry course, students develop a rich sense of the coherent, principled structure of chemistry and are both able and inclined to apply those principles in unfamiliar situations. In short, effective instruction should work toward the objectives identified in Section 1: Manitoba Foundations for Scientific Literacy.

**3. Effective teachers are sophisticated diagnosticians of student knowledge, reasoning, and participation.**

How teachers respond to student thinking depends critically on what they perceive in that thinking, on what they interpret to be the strengths and weaknesses of the students' understanding and approach. Effective teachers continually gather information to support this ongoing assessment from several different sources: written work on assignments, tests, and quizzes; classroom discussions; and contact with students outside the classroom. They ask students to explain their reasoning throughout their work, particularly through the appropriate and measured use of differentiated instruction techniques. Upon gaining new insights into student understanding, effective teachers adapt their instructional strategies and assessments.

**4. Effective teachers teach a smaller number of topics in greater depth, providing many examples in which the same concept is at work.**

This is a common refrain in findings from education research, often expressed in the slogan "less is more." In part, this finding is an implication of the previous two: drawing out and working with student understandings and addressing metacognitive skills and habits all take time, and this necessitates a reduction in the breadth of coverage. Education research also suggests that coming to understand a concept requires multiple encounters in a variety of contexts. This finding is reflected across this chemistry curriculum, drawing on the "spiralling" approach that revisits prior knowledge in new ways, or at an increased level of sophistication.

### **Making Interdisciplinary Connections in the Chemistry Classroom**

An important issue for a field as ancient as chemistry is how it adapts to the needs of society in a given place and time. The field of chemistry today faces a period of transition.

- A period in which technology and knowledge-based industries are the primary drivers of the national economy has begun.
- A period in which other areas of science, such as microbiology and genetics, will undergo rapid progress has also begun.
- The increasing availability, power, and sophistication of computational hardware and software will make possible novel quantitative descriptions of the physical universe. Society in general appears to be rapidly becoming more and more knowledge based. Enormous quantities of information are instantly available on ubiquitous computers.

Teachers of chemistry will need to be able to apply the body of knowledge developed within chemistry to totally new areas. In other words, chemistry teachers will be asked to become more interdisciplinary; they will have to apply their special knowledge and methods to problems that cross the boundaries of traditional disciplines.

On the other hand, the topics that possess several features that naturally allow students to begin to confront interdisciplinary issues are welcome, and align more closely to the new emphases outlined in Section 2: Manitoba Foundations for Scientific Literacy. First, there is the provision for interdisciplinary options (such as biomedical chemistry, historical chemistry, the nature of science as seen through chemistry) that teachers may choose to create.

Collaborative group work of students creates its interdisciplinary dimension through ownership of a collaborative scientific investigation. Such projects can easily involve applying knowledge and methods from several different scientific fields. Increased interdisciplinary content could be added to chemistry courses by developing more contexts such as the biomedical chemistry option mentioned above. Alternatively, the enriched chemistry course might choose to explore examples illustrating how fundamental physical principles apply to a wide variety of areas. For example, the elastic properties of DNA molecules might be used to discuss the range of validity of Hooke's law for spring forces. Biological cell membranes could be used to construct interesting examples of electrical potential differences and electric fields. In agreement with the National Research Council's *National Science Education Standards* (NSES), Manitoba Education, Citizenship and Youth encourages teachers to include some experiences with the interdisciplinary applications of chemistry when implementing the chemistry curriculum.

## Unit Development in Chemistry

Grade 11 Chemistry is driven by specific learning outcomes that can be arranged in a variety of groupings. This design empowers teachers to plan appropriate learning experiences based on the nature of their students, school, and community. Teachers are encouraged to seek their own instructional design with the new curriculum, to share approaches and experiences with colleagues, and to use an integrated interdisciplinary focus to develop and extend student experiences and understandings in new ways.

Working with bigger ideas can allow for a more in-depth inquiry. Organizing around a problem or theme will generally present information in the context of real-world applications (Willis). For instance, the treatment of vector analysis or free-body diagrams—usually taught in isolation as discrete mastery skills—could be better served by presenting these concepts at the time when the context will demand their use. Throughout the year, provide students with opportunities to uncover concepts from among the sciences in a substantial way, and to make coherent connections among them to chemistry.

Science deals with major themes in which people are already interested or can readily be interested: life and living things, matter, the universe, information, the “made-world.” A primary reason, therefore, for teaching science to young people is to pass on to them some of this knowledge about the material world, simply because it is both interesting and important—and to convey the sense of excitement that scientific knowledge brings (Millar and Osborne 7).

For teachers adopting a “thematic” or “big ideas from chemistry” approach to organizing the course, choosing an effective theme is critical to the success of such a pathway. Involving students in the selection of a theme (or the important subcomponents of a compulsory topic) will encourage and motivate them by recognizing their interests.

A theme should

- be broad enough for students to find personal areas of interest
- promote learning
- have substance and apply to the real world
- have relevant materials readily available
- be meaningful and age-appropriate
- have depth
- integrate across the disciplines of chemistry, biology, physics, and geosciences
- fascinate students (Willis)



## A View of Chemistry Education: Toward Modes of Representation

Ask your students to respond, in one sentence, to the question, “what is chemistry?” Responses tend to describe previous experiences with chemistry content: “chemistry is molecular motion,” or “chemistry is the study of energy and matter,” or “chemistry is like physics with lots of math in it,” or, from an educator’s standpoint, “chemistry is an understanding of particulate representations not visible to us.” Other responses are more global: “chemistry is the study of the makeup of the universe,” or “chemistry is the science of all things.” The relationship of mathematics to chemistry is predominant; a common lament is “chemistry is math” or “chemistry is figuring out the simple things in everyday life in a mathematically complex way” at the Senior Years. These responses indicate that students see mathematics as *the* process of chemistry. Many see chemistry as an important aspect of their preparation for an uncertain future, but with a varying sense of what chemistry really is and what it could do for them.

What is chemistry? Although answers vary, a common theme exists if we consider the various branches of chemistry and the underlying principles. Chemistry can also be considered as including *particulate representations* in the world we perceive around us. However, those relationships are embedded in visual, social, and historical contexts – a set of lenses through which the relationships are perceived and acted upon. For instance, we contemplate “something interesting,” and then build models to identify fundamental characteristics to determine how they interact and influence each other. From these relationships we are able to predict the behaviour of other “interesting things” that have the same or similar parameters. A major component of chemistry, then, is the study of relationships in a variety of different forms. What makes the study of chemistry so difficult for so many is that relationships can be represented in many different ways – and too often are shown in just one manifestation, the mathematical symbolic relationship.

### The Modes of Representation

The modes of representing relationships include the following:

- macroscopic (visual) mode
- numerical mode
- graphical mode
- symbolic mode
- particulate mode

To facilitate teaching and learning, it is important to understand the various modes of representation and their relationship to each other.

### Macroscopic (Visual) Mode

To illustrate the modes of representation, consider an example making use of the physical properties of gases under changes in pressure. Initially, a single book is placed on top of syringe apparatus (see illustration below). If we then enlarge the scope of the picture by adding other books, we can perceive that a relationship is emerging relating the amount of mass added to the syringe (that is, compressing the gas within the syringe) and the amount of compression in the gas sample. This is what we would call the *macroscopic (visual)* mode of representing a relationship. Its basis is in the “real” world of sense perception and our associated perceptions of how this “world” operates.

In the macroscopic (visual) mode, we suggest a relationship between two variables and then test our hypothesis by observation and experimentation. In the present case, as the downward force increases with the addition of more books, the syringe depresses in some easily observed proportional manner. Sometimes we can even determine the exact relationship. In this case, we can place a hypothetical “straight edge” to line up in a straight line across the syringes, and certainly this does seem to indicate that there is a predictable relationship.

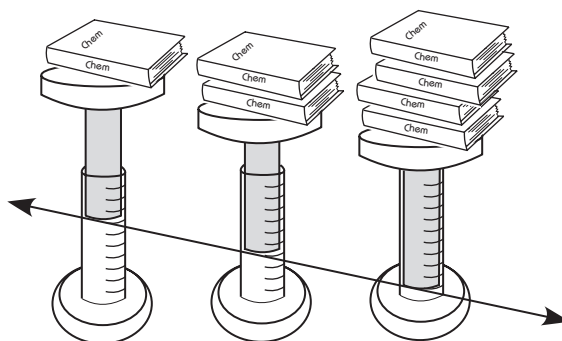

The macroscopic (visual) mode of representation embodies more than conjecture and observation. It incorporates critical and creative thinking as we build and modify models of nature that act as a foundation for our investigations. The “real” world is conceptualized by a set of guiding assumptions we imagine to be true. We may internalize a model to aid this conceptualization, and then we test this model using experiments. A successful model has explanatory and predictive capabilities. A model may incur discrepant events, which may force us to reconsider and modify our model. Our model may be falsified, in which case we abandon the model in search of a more complete and accurate model. For instance, the model of electric charge provides a foundation for the examination of electric phenomena. Historically, the fluid and particle models of charge accounted for experimental observations. However, as our ideas about the structure of matter evolved, the particle model provided a more reliable, predictive, and robust explanatory model.

Although we can make some general descriptions of relationships (e.g., as pressure increases, volume decreases), we cannot always determine an exact relationship using the macroscopic (visual) mode of representation. Therefore, we *quantify* the characteristics and compare the numbers. This is called the *numerical* mode of representation.

### Numerical Mode

In the *numerical* mode of representation, we *operationally define* fundamental properties and use measurement to collect data. In the case here, the pressure exerted on the gas is operationally defined as “changes in the position of the syringe” and is something we can readily see with the eyes. If there is no pressure applied, we see no change in the position of the syringe, and greater force implies greater pressure exerted on the air within the syringe. We can then examine the data to determine an exact relationship. The numerical mode dictates an understanding of proportioning and numerical patterns (e.g., if pressure [P] doubles, volume [V] is halved, and if P triples, V is reduced to a third of the original volume, and so on). This suggests a direct proportion, and we can then formulate a representative “law” describing the predictable behaviour of confined gas samples or other phenomena of interest. However, in most cases that students and researchers are involved in, the collection of data results in systematic errors. Determining the relationship by simple inspection of the data can be very difficult. A picture, however, is worth a thousand numbers to us. Graphing the data usually gives a clearer picture of the relationship. It could be looked upon, for students, as a preparation for examining closely a “picture of the numbers” (the graph).

The following data table is an example of a numerical mode that is of importance to us at Grade 11 – to identify a *direct relationship* if that is the case, or an *inverse relationship* such as in the example here (volume and pressure in a gas sample):

Volume and Pressure in a Gas	
Volume (mL)	Pressure (mmHg)
30.5	739.8
20.3	1122.4
15.2	1493.8
10.2	2232.0

## Graphical Mode

The *graphical* mode of representation is a mathematical picture of the relationship. Fortunately, there are a limited number of pictures one needs to know to determine relationships. In fact, at the introductory Grade 11 Chemistry level, it is only necessary to know three pictures that derive from mathematical relationships: a straight line, a power curve, and an inverse curve. By adjusting the data to “straighten the curve,” we can determine the exact relationship and formulate a law that can be represented in a symbolic manner.

For our purposes here, there can be no better example of the power of mathematical modelling than that from the relationship between the volume of a gas sample and the pressure it exerts on the walls of a container. We, of course, know this as Boyle’s Law, but it is instructive to view this from the point of view of students and our discussion here of modes of representation. Below is a graphical representation of numerical data from a fictitious student lab experience based on Robert Boyle’s original data:

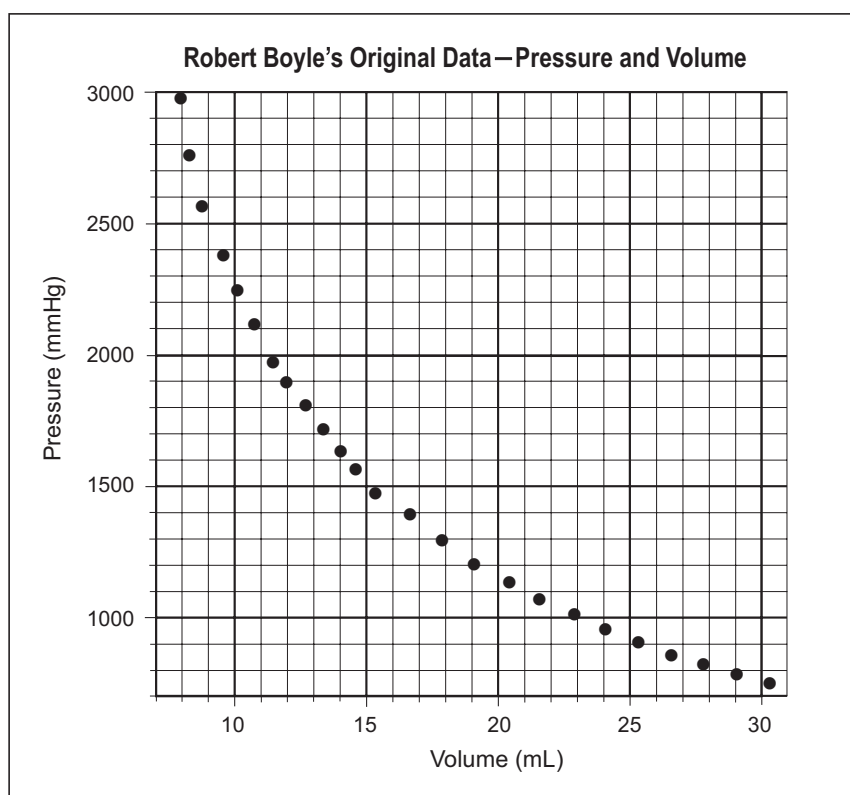

We would expect two things to arise from a discussion of this “picture.” First, the relationship is inverse in some way (as one variable gets larger, the responding variable gets smaller). Second, the inverse behaviour is not “one to one”; that is, it is not a linear relationship. We cannot expect that either volume or pressure can increase or decrease indefinitely in realistic terms. In order to “tease out” or model the physical law that explains this behaviour of gases under pressure, students are instructed in the techniques for *curve straightening* at Grade 11. This technique directly links the *graphical* and *symbolic* modes of representation.

Let's see how this is accomplished. Our initial mathematical model states, using the present example with gases, that some sort of inverse relationship exists between volume and pressure. Expressing this as follows is a good starting point:

Pressure goes down as volume goes up.

$$P \propto \frac{1}{V}$$

or

$$P = k \cdot V^{-1}$$

The implication is that if we replot that data, but this time plot the *inverse of volume* against pressure, a new relationship should become visible:

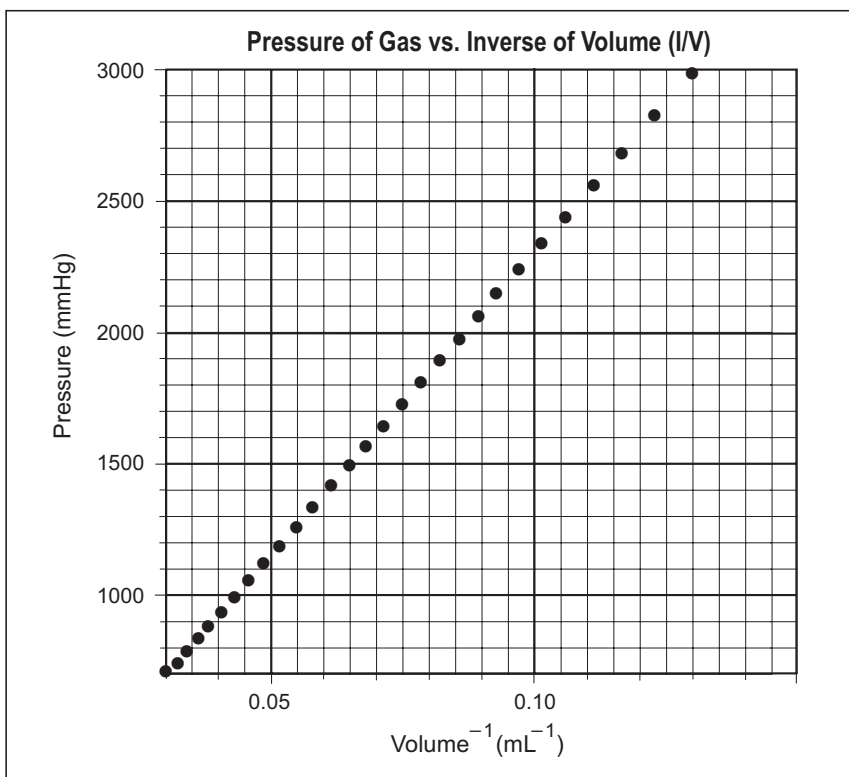

### Symbolic Mode

The fourth mode of representation is the *symbolic* mode. To continue with our example using Boyle's Law, we represent the relationship between the pressure and volume of a gas as an *algebraic* relationship, which can be applied to other physical events that are similar in nature. When we look again at the last graph plotting the inverse of volume with pressure, it is clearly evident that a direct relationship exists between these two quantities. It would be very easy to determine a line of "best fit" for this graph, determine the slope of that line, and close off the discussion with the statement of a fundamental physical law.

If  $P = k \cdot V^{-1}$ , then  $P \cdot V = \text{a constant } (k)$ .

We then can state Boyle's Law as the product of pressure and volume as being a constant....

Thus far, we have represented relationships in four different modes: macroscopic (visual), numerical, graphical, and symbolic. In our model of chemistry education, students should be afforded the opportunity to function in each mode of representation to demonstrate growing understanding and mastery of these modes conceptually.

### Parciculate Mode

Now, we will discuss a fifth mode of representation: *particulate* representations. Throughout Grade 11 Chemistry, students will regularly involve themselves with modelling chemical phenomena. This will include building ball-and-stick models, using software simulations, or drawing pictures of events that are occurring at the nanometre scale and are beyond our spatial constraints. For instance, we could illustrate the gas sample featured in this discussion in this manner:

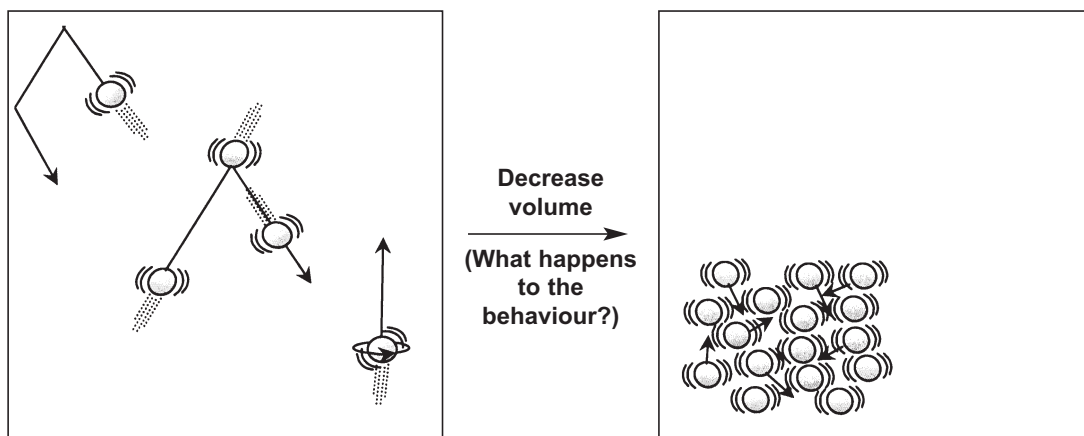

### **The Importance of the Modes of Representation**

It is easy to become caught up in a single mode of representation, especially the symbolic mode, when teaching and learning chemistry. Students often complain about the number of calculations in their chemistry course, or question their purpose. They dutifully memorize equations and notation, learn to substitute for variables, and arrive at numerical solutions. Students and teachers can easily become trapped exclusively within the symbolic mode of representation. Instruction using the symbolic mode is easy because little or no preparation is required. The teacher, already grounded in mathematical principles, only needs to derive an equation algebraically. This “out of context” treatment of relationships between the physical/conceptual (i.e., visual mode variables) and the symbolic presents tremendous difficulties for most students, including those students who are apparently mathematically competent.

Meaningful connections between the symbolic and physical/conceptual modes are difficult to make in a decontextualized setting. Many teachers, whose own instruction in chemistry may have been primarily in the symbolic mode, may never have mediated their own conceptual difficulties. Students taught exclusively in the symbolic mode often know how to arrive at “cookbook” answers, but they rarely understand the chemistry or retain the concepts. In fact, their difficulties rarely focus on chemistry. Confusion appears because of notation, similar types of equations, various algebraic representations of formulas, and calculations. As soon as physical concepts are necessary, as in word problems beyond the “plug and slug” variety, success rates decrease dramatically. Research in chemistry education indicates that many advanced students experience difficulties when operating in the physical/conceptual domain, but do calculations with apparent ease and success. This, of course, may not be surprising if students’ instruction has been almost exclusively in the symbolic mode of representation.

Students need to develop their understanding of relationships more completely, and develop skills in each mode of representation. Students should be able to transfer between modes both fluidly and with facility. Moving through the modes is not necessarily done in consecutive order. A “real scientist” can begin investigations in any mode and transfer easily through any combination of modes. Students who demonstrate a complete understanding of physical/conceptual relationships should be able to move from mode to mode in any order.

While fluency with the modes of representation provides a solid foundation for chemistry education, it is, of itself, not complete when portraying the nature of scientific activity. Albert Einstein, while developing his theory of relativity, conceptualized a hypothesis and then deduced a series of laws symbolically from a set of fundamental assumptions about time and space. He left it to others to observe, and then refute or confirm his propositions. Historical perspectives, and an understanding of the nature of science, will move students toward a more philosophically valid treatment of chemistry.

### Summing up the Modes of Representation for Chemistry Teachers

**Macroscopic (Visual):** Encourage students to discuss the representations they see and experience.

**Numerical:** Use student-generated measurements—always in the context of activities.

**Graphical:** Carefully plot graphs; get the “picture of the numbers,” not “this is a picture of the world.”

**Symbolic:** Emphasize the concept first, and then initially apply formulas as word definitions. Only then work “type” problems using formulas. Ideally, formulas are memorized only in certain instances.

**Particulate:** Frequently make use of physical models that explain or illustrate the invisible world of molecular structure and behaviour. Attempt to connect physical phenomena with the underlying micro-scale movements of *particles*.

### Toward an Instructional Philosophy in Chemistry

Teaching Grade 11 Chemistry with a focus on both content and processes naturally allows for the use of a variety of instructional strategies. These strategies include the collection and analysis of data from both laboratory work and field work, group and individual instruction, a diversity of questioning techniques, decision-making, problem-solving, and design-process activities, and a resource-based approach to learning. Senior Years science programming should foster critical thinking skills and promote the integration of knowledge and the application of facts to real-life situations. Scientific concepts from other Senior Years science courses may become part of the subject matter as the Grade 11 Chemistry course develops in the classroom. This approach is a valuable and useful means of reinforcing and validating scientific concepts as having relevant and contextual applications.

Chemistry is, in part, a way of thinking that has rules for judging the validity of answers applicable to everyday life. It is an intense human activity, full of trial and error that is influenced by cultural priorities and humanistic perspectives. The myth of total objectivity that often permeates scientific dialogue also needs to be exposed and discussed. Among the natural sciences, “scientific truth” is no longer viewed as an objective reality awaiting discovery; rather, it is placed in the context of something always to be sought. In recognition of the tentative nature of current knowledge claims, “scientific truth” is not a goal that can be reached in absolute terms, but can remain as one of the hallmarks of the traditions of scientific practice.

Students should be encouraged to make distinctions between what is observable and testable, as well as develop the ability to consider the abstract deductions, models, and themes that derive from evolving scientific research and thinking.



Conceptual knowledge in science can also be integrated with principles from other disciplines. The inclusion of social, historical, and political implications in the study of chemistry provides students with opportunities to develop a facility to communicate ideas effectively through verbal and written expression. Finally, students will benefit from opportunities to develop an awareness of the options available to them for careers and vocations in the wide diversity of sciences.

Grade 11 Chemistry, as a component of young people’s whole educational experience, will assist in preparing them for a full and satisfying life. This curriculum will sustain and develop the curiosity of young people about the natural world around them, and build their confidence in their ability to inquire into its behaviour, now and in the future. It seeks to foster a sense of wonder, enthusiasm, and interest in science so that young people will feel confident and competent to engage with everyday scientific and technological applications and solutions.

As students study a range of topics through various sub-disciplines of chemistry, they will develop a broad, general understanding of the important ideas and explanatory frameworks of the field as a whole, including the procedures of scientific inquiry that have had a major impact on our material environment and on our culture. They will develop an appreciation for why these ideas are valued and the underlying rationale for decisions that they may wish, or may be advised, to take in everyday contexts, both now and in later life. They will be able to understand, and respond critically to, media reports of issues with a science (particularly a chemistry-related) component. Finally, students will feel empowered to hold and express personal viewpoints on issues with a science component that enter the arena of public debate, and perhaps to become actively involved in some of these issues (Millar and Osborne 12).

### Results-Based Learning

In results-based learning, the programming focus is on what students know and can do, rather than on what material is “covered.” The learning outcomes are an elaboration of the knowledge, strategies, and skills and attitudes expected of each Grade 11 Chemistry student. All programming decisions are directed toward addressing the gap between the students’ present level of performance and the performance specified in the learning outcomes.

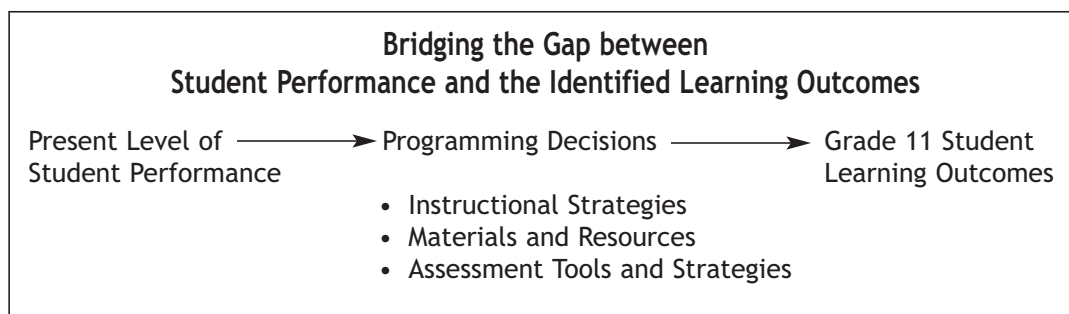

**Results-Based Learning:** Adapted from Section 2-3 of *Senior 3 English Language Arts: A Foundation for Implementation*. Copyright © 1999 by Manitoba Education and Training.

The student learning outcomes are not taught separately or in isolation. Nor are they taught consecutively in the order in which they appear in the curriculum documents. Most lessons or units draw on knowledge, skills and strategies, and attitudes addressed in several or all general learning outcomes. In the process of planning, teachers are encouraged to identify the learning outcomes they intend to assess, and link all assessment to the specific learning outcomes.

In implementing results-based curricula, experienced teachers may find that they use many of the instructional strategies and resources they have used previously. However, the nature of results-based learning will reshape their programming in several ways:

- Planning is ongoing throughout the semester or year because instruction is informed by learning requirements that become evident through continuous assessment.
- Some learning outcomes, especially skills and attitudes outcomes, are addressed repeatedly in different ways throughout the school semester or year. As students develop new scientific knowledge, skills and strategies, and attitudes, they need to practise and refine those they have previously experienced.

### **Varied Instructional Approaches**

Teachers wear a number of different “pedagogical hats,” and change their teaching styles in relation to the cognitive gains, attitudes, and skills demanded of the task at hand (Hodson). In planning instruction for Grade 11 Chemistry, teachers may draw upon a repertoire of instructional approaches and methods and use combinations of these in each unit and lesson. Many suggestions are contained in this document.

Instructional approaches may be categorized as

- direct instruction
- indirect instruction
- experiential learning
- independent study
- interactive instruction

Most teachers draw from all these categories to ensure variety in their classroom learning experiences, to engage students with various intelligences and a range of learning approaches, and to achieve instructional goals.

---

**Varied Instructional Approaches:** Adapted from Section 2-4 of *Senior 3 English Language Arts: A Foundation for Implementation*. Copyright © 1999 by Manitoba Education and Training.

The following diagram displays instructional approaches and suggests some examples of methods within each approach. Note that the approaches overlap.

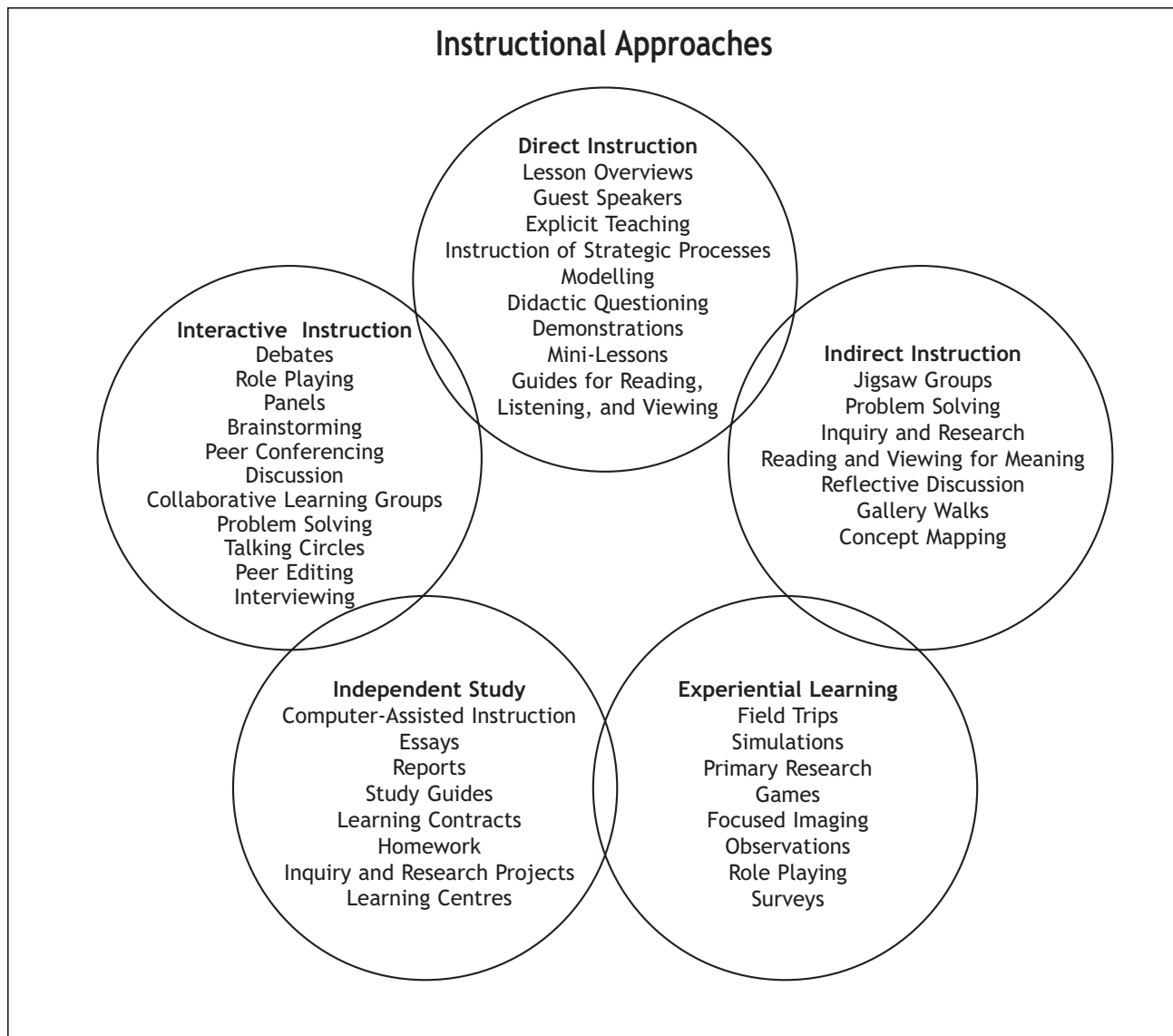

**Instructional Approaches:** Adapted from Saskatchewan Education, *Instructional Approaches: A Framework for Professional Practice* (Regina, SK: Saskatchewan Education, 1991) 20. Adapted by permission of Saskatchewan Learning.

## Instructional Approaches

In selecting instructional approaches and methods, teachers consider which combination will assist students in achieving the learning outcomes targeted for a particular lesson or unit. Teachers consider the advantages and limitations of the approaches and methods, as well as the interests, knowledge, skills, and attitudes of their students. Some of these elements are represented in the following chart.

<b>Instructional Approaches: Roles, Purposes, and Methods</b>				
<b>Instructional Approaches</b>	<b>Roles</b>	<b>Purposes/Uses</b>	<b>Methods</b>	<b>Advantages/Limitations</b>
<b>Direct Instruction</b>	<ul style="list-style-type: none"> <li>• Highly teacher-directed</li> <li>• Teacher uses didactic questioning to elicit student involvement</li> </ul>	<ul style="list-style-type: none"> <li>• Providing information</li> <li>• Developing step-by-step skills and strategies</li> <li>• Introducing other approaches and methods</li> <li>• Teaching active listening and note making</li> </ul>	Teachers: <ul style="list-style-type: none"> <li>• Explicit teaching</li> <li>• Lesson overviews</li> <li>• Guest speakers</li> <li>• Instruction of strategic processes</li> <li>• Lecturing</li> <li>• Didactic questioning</li> <li>• Demonstrating and modelling prior to guided practice</li> <li>• Mini-lessons</li> <li>• Guides for reading, listening, and viewing</li> </ul>	<ul style="list-style-type: none"> <li>• Effective in providing students with knowledge of steps of highly sequenced skills and strategies</li> <li>• Limited use in developing abilities, processes, and attitudes for critical thinking and interpersonal learning</li> <li>• May encourage passive, not active learning</li> </ul>
<b>Indirect Instruction</b>	<ul style="list-style-type: none"> <li>• Mainly student-centred</li> <li>• Teacher's role shifts to facilitator, supporter, resource person</li> <li>• Teacher monitors progress to determine when intervention or another approach is required</li> </ul>	<ul style="list-style-type: none"> <li>• Activating student interest and curiosity</li> <li>• Developing creativity and interpersonal skills and strategies</li> <li>• Exploring diverse possibilities</li> <li>• Forming hypotheses and developing concepts</li> <li>• Solving problems</li> <li>• Drawing inferences</li> </ul>	Students: <ul style="list-style-type: none"> <li>• Observing</li> <li>• Investigating</li> <li>• Inquiring and researching</li> <li>• Jigsaw groups</li> <li>• Problem solving</li> <li>• Reading and viewing for meaning</li> <li>• Reflective discussion</li> <li>• Concept mapping</li> </ul>	<ul style="list-style-type: none"> <li>• Active involvement an effective way for students to learn</li> <li>• High degree of differentiation and pursuit of individual interests possible</li> <li>• Excellent facilitation and organizational skills required of teachers</li> <li>• Some difficulty integrating focused instruction and concepts of content</li> </ul>

(continued)

**Instructional Approaches: Roles, Purposes, and Methods:** Adapted from Section 2-5 and 2-6 of *Senior 3 English Language Arts: A Foundation for Implementation*. Copyright © 1999 by Manitoba Education and Training.

<b>Instructional Approaches: Roles, Purposes, and Methods (continued)</b>				
<b>Instructional Approaches</b>	<b>Roles</b>	<b>Purposes/Uses</b>	<b>Methods</b>	<b>Advantages/Limitations</b>
<b>Interactive Instruction</b>	<ul style="list-style-type: none"> <li>• Student-centred</li> <li>• Teacher forms groups, teaches and guides small-group skills and strategies</li> </ul>	<ul style="list-style-type: none"> <li>• Activating student interest and curiosity</li> <li>• Developing creativity and interpersonal skills and strategies</li> <li>• Exploring diverse possibilities</li> <li>• Forming hypotheses and developing concepts</li> <li>• Solving problems</li> <li>• Drawing inferences</li> </ul>	Students participating in: <ul style="list-style-type: none"> <li>• Discussions</li> <li>• Sharing</li> <li>• Generating alternative ways of thinking and feeling</li> <li>• Decision making</li> <li>• Debates</li> <li>• Role-playing</li> <li>• Panels</li> <li>• Brainstorming</li> <li>• Peer conferencing</li> <li>• Collaborative learning groups</li> <li>• Problem solving</li> <li>• Talking circles</li> <li>• Interviewing</li> <li>• Peer editing</li> </ul>	<ul style="list-style-type: none"> <li>• Increase of student motivation and learning through active involvement in groups</li> <li>• Key to success is teacher's knowledge and skill in forming groups, instructing, and guiding group dynamics</li> <li>• Effective in assisting students' development of life skills in cooperation and collaboration</li> </ul>
<b>Experiential Instruction</b>	<ul style="list-style-type: none"> <li>• Student-centred</li> <li>• Teacher's role may be to design the order and steps of the process</li> </ul>	<ul style="list-style-type: none"> <li>• Focusing on processes of learning rather than on products</li> <li>• Developing students' knowledge and experience</li> <li>• Preparing students for direct instruction</li> </ul>	Students participating in: <ul style="list-style-type: none"> <li>• Learning activities</li> <li>• Field trips</li> <li>• Simulations</li> <li>• Primary research</li> <li>• Games</li> <li>• Focused imaging</li> <li>• Role-playing</li> <li>• Surveys</li> <li>• Sharing observations and reflections</li> <li>• Reflecting critically on experiences</li> <li>• Developing hypotheses and generalizations in new situations</li> </ul>	<ul style="list-style-type: none"> <li>• Increase in student understanding and retention</li> <li>• Additional resources and time required for hands-on learning</li> </ul>
<b>Independent Study</b>	<ul style="list-style-type: none"> <li>• Student-centred</li> <li>• Teacher's role to guide or supervise students' independent study, teach knowledge, skills, and strategies that students require for independent learning, and provide adequate practice</li> </ul>	<ul style="list-style-type: none"> <li>• Accessing and developing student initiative</li> <li>• Developing student responsibility</li> <li>• Developing self-reliance and independence</li> </ul>	Students participating in: <ul style="list-style-type: none"> <li>• Inquiry and research projects</li> <li>• Using a variety of approaches and methods</li> <li>• Computer-assisted instruction</li> <li>• Essays and reports</li> <li>• Study guides</li> <li>• Learning contracts</li> <li>• Homework</li> <li>• Learning centres</li> </ul>	<ul style="list-style-type: none"> <li>• Students grow as independent, lifelong learners</li> <li>• Student maturity, knowledge, skills, and strategies important to success</li> <li>• Student access to resources essential</li> <li>• Approach flexible (may be used with individual students while other students use other approaches)</li> </ul>

### Linking Instructional Approaches with Specific Instructional Strategies

The interactions of the five instructional approaches just discussed can be linked to more specific strategies commonly found within this curriculum document. Although not exhaustive, the instructional strategies that follow may be used with Grade 11 Chemistry as starting points toward a broader array of strategically used classroom learning experiences with students.

#### *Direct Instruction*

- **Teacher demonstrations:** Demonstrations, such as discrepant events, may be used to arouse student interest and allow for visualization of phenomena. Demonstrations can activate prior knowledge and generate discussion around learning outcomes.
- **Community connections:** Field trips and guest speakers may provide students with opportunities to see science applied in their community and in local natural environments.
- **Prior knowledge activities:** Students learn best when they are able to relate new knowledge to what they already know. Brainstorming, KWL (Know, Want to know, Learned) charts, and Listen-Think-Pair-Share (see *SYSTH*, Chapter 9)\* are just a few of the strategies that may be used to activate and assess students' prior knowledge.

#### *Indirect Instruction*

- **Class discussion (teacher facilitated):** Discussions may be used in a variety of ways. They may spark interest in a topic or learning outcome, activate prior knowledge by inviting speculation on why certain events occur, or generate ideas for solutions to problems.
- **Collaborative teamwork:** Instructional strategies, such as the Jigsaw or Roundtable (see *SYSTH*, 3.19, 3.20, and Appendix 6), encourage students to learn from one another and to develop teamwork skills. The use of cooperative learning activities may lead to increased understanding of content and improved thinking skills.

#### *Interactive Instruction*

- **Class discussion (student facilitated):** Student-led discussions may be used with groups of students who are amenable to this form of interaction once procedures have been well developed in advance. They may spark interest in a topic or learning outcome, activate prior knowledge by inviting speculation on why certain events occur, or generate ideas for solutions to problems.
- **Debates:** Debates draw upon students' own positions on STSE issues. When carefully structured, debates may be used to encourage students' consideration of societal concerns and the opinions of others, and improve their communication and research skills.

---

\* For a discussion of these and other instructional strategies, see *Senior Years Science Teacher's Handbook* (Manitoba Education and Training) – abbreviated as *SYSTH* in this document.

### *Experiential Learning*

- **Student research/reports:** Learning projects that involve student research are among the most effective ways to individualize instruction in a diverse classroom. These learning activities provide students with opportunities to develop their research skills as they gather, process, and evaluate information.
- **Problem-based learning (PBL):** PBL is a curricular design that centres on an authentic problem. Students are assigned roles and presented with a problem that has no single, clear-cut solution. Students acquire content knowledge as they work toward solving the problem.
- **Journal writing:** Science journal writing allows students to explore and record various aspects of their experiences in science class. By sorting out their thoughts on paper or thinking about their learning (metacognition), students are better able to process what they are learning.
- **Laboratory activities:** Laboratory activities, whether student- or teacher-designed, provide students with opportunities to apply their scientific knowledge and skills related to a group of learning outcomes. Students will appreciate the hands-on experience of *doing* science, as opposed to a sense of just learning about science.

### *Independent Study*

- **WebQuests:** A WebQuest is an inquiry-oriented activity in which most or all of the information used by learners comes from resources on the Internet. WebQuests are designed to use learners' time well, to focus on using information rather than looking for it, and to support learners' thinking at the levels of analysis, synthesis, and evaluation.
- **Visual displays:** When students create visual displays, they make their thinking visible. Generating diagrams, concept maps, posters, and models provides students with opportunities to represent abstract information in a more concrete form.

### **Phases of Learning**

When preparing instructional plans and goals, many teachers find it helpful to consider three learning phases:

- **activating** (preparing for learning)
- **acquiring** (integrating and processing learning)
- **applying** (consolidating learning)

These phases are not entirely linear but are a useful way of thinking and planning. A variety of activating, acquiring, and applying strategies are discussed in *Success for All Learners: A Handbook on Differentiating Instruction* and in *Senior Years Science Teachers' Handbook* (Manitoba Education and Training).

---

**Phases of Learning:** Adapted from Section 2-6 to 2-8 of *Senior 3 English Language Arts: A Foundation for Implementation*. Copyright © 1999 by Manitoba Education and Training.

### *Activating (Preparing for Learning)*

One of the strongest indications of how well students will comprehend new information is their prior knowledge of the subject. Some educators observe that more student learning occurs during this activating phase than at any other time. In planning instruction and assessment, teachers develop student learning experiences and select strategies for activating their students' prior knowledge. Using these activating strategies, the learning experiences then provide information about the extent of students' prior knowledge of the topic to be studied, their knowledge of and familiarity with the context in which that knowledge was acquired, and their knowledge of and proficiency in applying skills for learning.

Learning experiences that draw on students' prior knowledge

- help students relate new information, skills, and strategies to what they already know and can do (e.g., if a text includes unfamiliar vocabulary, students may not recognize the connection between what they know and the new material being presented)
- allow teachers to recognize misconceptions that might make learning difficult for students
- allow teachers to augment and strengthen students' knowledge base when students do not possess adequate prior knowledge and experience to engage with new information and ideas
- help students recognize gaps in their knowledge
- stimulate curiosity and initiate the inquiry process that will direct learning

### *Acquiring (Integrating and Processing Learning)*

In the second phase of learning, students engage with new information and integrate it with what they already know, adding to and revising their previous knowledge. Part of the teacher's role in this phase is to present this new information or to help students access it from various resources.

Since learning is an internal process, however, facilitating learning requires more of teachers than simply presenting information. In the acquiring phase, teachers instruct students in strategies that help them make meaning of information, integrate it with what they already know, and express their new understanding. In addition, teachers monitor these processes to ensure that learning is taking place, using a variety of instruments, tools, and strategies such as observations, conferences, and examination of student work.

In practice, within an actual lesson or unit, the acquiring phase of learning may include a series of steps and strategies, such as

- setting the purpose (e.g., discrepant events, lesson overviews, learning logs, Admit Slips)
- presenting information (e.g., lab demonstrations, guest speakers, mini-lessons, active reading)
- processing information (e.g., note making, group discussions, journals, visual representations)



- modelling (e.g., role-playing, demonstrations)
- checking for understanding (e.g., quizzes, informal conferences)

### *Applying (Consolidating Learning)*

New learning that is not reinforced is soon forgotten. The products and performances by which students demonstrate new learning are not simply required for assessment; they have an essential instructional purpose in providing students with opportunities to demonstrate and consolidate their new knowledge, skills and strategies, and attitudes. Students also need opportunities to reflect on what they have learned and to consider how new learning applies to new situations. By restructuring information, expressing new ideas in another form, or integrating what they have learned in science with concepts from other subject areas, students strengthen and extend learning.

To ensure that students consolidate new learning, teachers plan various learning experiences involving

- reflection (e.g., journals, Exit Slips)
- closure (e.g., sharing of products, debriefing on processes)
- application (e.g., inquiry, design process)

### **Differentiating Instruction**

How can Senior Years science teachers meet each student's learning requirements and still make learning experiences challenging and meaningful for all? One way to help all students achieve the identified student learning outcomes is to differentiate the instructional strategies. Grade 11 Chemistry makes reference to a variety of field-validated strategies for differentiating instruction. Most have been taken from the support document *Senior Years Science Teachers' Handbook* (Manitoba Education and Training).

Through differentiating instruction, teachers can

- activate students' prior knowledge
- accommodate multiple intelligences and the variety of learning and thinking approaches
- help students interpret, apply, and integrate information
- facilitate the transfer of knowledge, skills and strategies, and attitudes to students' daily lives
- challenge students to realize academic and personal progress and achievement

Differentiating instruction does not mean offering different programming to each student. Classroom experiences can be differentiated by offering students choices and by varying instructional and assessment strategies to provide challenging and effective learning experiences for all. Ideas for differentiating instruction are provided in *Senior Years Science Teachers' Handbook* and in *Success for All Learners: A Handbook on Differentiating Instruction* (Manitoba Education and Training).

### **Promoting Strategic Learning**

Many of the tasks science students perform are problem-solving tasks, such as finding sources of information for an inquiry project, making meaning of a difficult text, or organizing a body of information. To solve problems, students require a strategic mindset; when confronted with a problem, students survey a number of possible strategies, select the one that seems likely to work best for the situation, and try an alternative method if the first one does not produce results.

Strategic learners in the sciences need to have not only a strategic mindset, but also a repertoire of strategies for making meaning, for processing information, and for expressing ideas and information effectively. Whereas skills are largely unconscious mental processes that learners use in accomplishing learning tasks, strategies are systematic and conscious plans, actions, and thoughts that learners select or invent and adapt to each task. Strategies are often described as “knowing what to do, how to do it, when to do it, and why it is useful.”

### ***Scaffolding: Supporting Students in Strategic Learning***

Many scientific tasks involve a complex interaction of skills. The most effective way to learn, however, is not by breaking down the tasks into manageable parts and teaching the skills separately and in isolation. In fact, this approach may be counterproductive. Purcell-Gates uses the analogy of learning to ride a bicycle, a skill that requires children to develop an intuitive sense of balance while also learning to pedal and steer. Children do not learn to ride a bicycle by focusing on only one of these skills at a time. Instead, they observe others who can ride a bicycle successfully, and then make an attempt themselves. In the early stages of learning to ride, a child counts on someone to provide support—to hold the bicycle upright while the child mounts, to keep a hand on the seat to stabilize the bicycle for the first few metres, and to coach and encourage. Gradually, these supports are withdrawn as the rider becomes more competent. Eventually, the process becomes automatic, and the rider is no longer aware of the skills being performed.

Providing this sort of support in teaching is called “scaffolding,” based on the work of Wood, Bruner, and Ross. Teachers scaffold by

- structuring tasks so that learners begin with something they can do
- reducing the complexity of tasks
- calling students’ attention to critical features of the tasks
- modelling steps
- providing sufficient guided and independent practice

---

**Promoting Strategic Learning:** Adapted from Section 2-8 of *Senior 3 English Language Arts: A Foundation for Implementation*. Copyright © 1999 by Manitoba Education and Training.

In a sense, each learning strategy is an external support or scaffold. At first, working with a new strategy may be challenging and the main focus of students' attention. Eventually, students use the strategy automatically and rely on it as a learning tool. Students gradually internalize the process of the strategy. They begin to adjust and personalize the process and to apply the thinking behind the strategy automatically.

In strategic instruction, teachers observe and monitor students' use of a strategy for a time, intervening where necessary. Students vary in the length of time they require scaffolding. In this respect, strategic instruction is also a useful tool for differentiation. Struggling learners may work with simplified versions of a strategy, and they may continue to use the supports of a strategy (for example, a graphic organizer for laboratory reports) after other students have internalized the process.

Strategic instruction works best when teachers pace the instruction of new strategies carefully (so that students have time to practise each one), and when they teach a strategy in the context of a specific task of relevant scientific experience.

# SECTION 3:

## ASSESSMENT IN GRADE 11 CHEMISTRY

---

Classroom Assessment	3
Planning for Assessment	3
Characteristics of Effective Assessment	4
Managing Classroom Assessment	8
Changing Emphases in Assessment	10
Types of Assessment	11



# ASSESSMENT IN GRADE 11 CHEMISTRY

## Classroom Assessment

Classroom assessment is an integral part of science instruction. Assessment could be described as the “systematic process of gathering information about what a student knows, is able to do, and is learning to do” (Manitoba Education and Training, *Reporting on Student Progress and Achievement* 5). The primary purpose of classroom assessment is not to evaluate and classify student performance, but to inform teaching and improve learning, and to monitor student progress in achieving year-end learning outcomes.

Rather than emphasizing the recall of specific, detailed and unrelated “facts,” [assessment in science] should give greater weight to an assessment of a holistic understanding of the major scientific ideas and a critical understanding of science and scientific reasoning (Millar and Osborne 25).

Classroom assessment is broadly defined as any activity or experience that provides information about student learning. Teachers learn about student progress not only through formal tests, examinations, and projects, but also through moment-by-moment observation of students in action. They often conduct assessment through instructional activities.

Much of students’ learning is internal. To assess students’ science knowledge, skills and strategies, and attitudes, teachers require a variety of tools and approaches. They ask questions, observe students engaged in a variety of learning activities and processes, and examine student work in progress. They also engage students in peer-assessment and self-assessment activities. The information that teachers and students gain from assessment activities informs and shapes what happens in the classroom; assessment always implies that some action will follow.

To determine whether student learning outcomes have been achieved, student assessment must be an integrated part of teaching and learning. Assessment of student learning involves careful planning and systematic implementation.

## Planning for Assessment

Assessment purposes, approaches, and tools should be developed with instructional approaches during the planning of the unit. In developing assessment tasks and methods, teachers determine

- what they are assessing
- why they are assessing
- how the assessment information will be used
- who will receive the assessment information
- what assessment activities or tasks will allow students to demonstrate their learning in authentic ways

## Characteristics of Effective Assessment

Effective assessment helps focus effort on implementing strategies to facilitate learning both inside and outside the classroom. Effective assessment is

- congruent with instruction and integral to it
- ongoing and continuous
- based on authentic tasks and meaningful science-learning processes and contexts
- based on criteria that students know and understand and that appeal to their strengths
- a collaborative process involving students
- multi-dimensional and uses a wide range of tools and methods
- focused on what students have learned and can do

### Effective Assessment Is Congruent with (and Integral to) Instruction

Assessment requires teachers to be aware continually of the purpose of instruction: What do I want my students to learn? What can they do to show that they have learned it?

How teachers assess depends on what they are assessing—whether they are assessing declarative knowledge, procedural knowledge, or attitudes and habits of mind.

- **Declarative knowledge:** If teachers wish to measure fact-based recall, declarative knowledge is the most straightforward dimension of learning to measure using traditional tools. The purpose of fostering scientific literacy, however, is not met if students simply memorize the declarative knowledge related to science; what is more important is whether students understand and are able to apply this knowledge. For example, it is more important that they understand the purposes and effects of biodiversity, that they respond to and interpret what biodiversity means for them personally and environmentally, and that they use terminology with ease to enrich their scientific communication skills, and represent—rather than reproduce—a definition of biodiversity. The challenge teachers face is to design tools that test the application of declarative knowledge.
- **Procedural knowledge:** Tools that are designed to test declarative knowledge cannot effectively assess skills and processes. For example, rather than trying to infer student processes by looking at final products, teachers assess procedural knowledge by observing students in action, by discussing their strategies with them in conferences and interviews, and by gathering data from student reflections, such as journals.

---

**Characteristics of Effective Assessment:** Adapted from Section 2-10 to 2-14 of *Senior 3 English Language Arts: A Foundation for Implementation*. Copyright © 1999 by Manitoba Education and Training.

- **Attitudes and habits of mind:** Attitudes and habits of mind cannot be assessed directly. They are implicit in what students do and say. Assessment tools typically describe the behaviours that reflect the attitudes and habits of scientifically literate individuals. They identify the attitudes and habits of mind that enhance science-related language learning and use, and provide students with the means to reflect on their own internal processes. For example, rather than assigning global marks for class participation, teachers assess learning outcomes related to students' effective contributions to large and small groups.

Assessment is intended to inform students of the programming emphases and to help them focus on important aspects of learning. If teachers assess only the elements that are easiest to measure, students may focus only on those things. For example, if science courses place a high value on collaboration, creativity, and divergent thinking (learning outcomes that may be more difficult to measure), then assessment tools and processes must reflect those values. The ways teachers assess (what and how) inform students of what is considered important in learning.

### **Effective Assessment Is Ongoing and Continuous**

Assessment that is woven into daily instruction offers students frequent opportunities to gain feedback, to modify their learning approaches and methods, and to observe their progress. Teachers provide informal assessment by questioning students and offering comments. They also conduct formal assessments at various stages of a project or unit of study.

Continuous assessment provides ongoing opportunities for teachers to review and revise instruction, content, process emphases, and learning resources.

### **Effective Assessment Is Based on Authentic Tasks and Meaningful Science-Learning Processes and Contexts**

Assessment tasks in science should be authentic and meaningful – tasks worth mastering for their own sake, rather than tasks designed simply to demonstrate student proficiency for teachers and others. Through assessment, teachers discover whether students can use knowledge, processes, and resources effectively to achieve worthwhile purposes. Therefore, teachers design tasks that replicate the context in which knowledge will be applied in the world beyond the classroom.

For example, authentic science writing tasks employ the forms used by a wide range of people (for example, scientists, journalists, filmmakers, poets, novelists, publicists, speakers, technical writers, engineers, and academics). As often as possible, students write, speak, or represent their ideas for real audiences and for real purposes. In developing assessment tasks, teachers may consider providing students with the resources people use when performing the same tasks in real-life situations related to issues in science.

Authentic assessment tasks are tests not only of the information students possess, but also of the way their understanding of a subject has deepened, and of their ability to apply learning. They demonstrate to students the relevance and importance of learning. Performance-based tests are also a way of consolidating student learning. The perennial problem teachers have with “teaching to the test”



is of less concern if tests are authentic assessments of student knowledge, skills and strategies, and attitudes.

### **Effective Assessment Is Based on Criteria That Students Know and Understand and That Appeal to Their Strengths**

Assessment criteria must be clearly established and made explicit to students before an assignment or a test so that students can focus their efforts. In addition, whenever possible, students need to be involved in developing assessment criteria. Appendix 9: Developing Assessment Rubrics in Science describes a process for creating assessment rubrics in collaboration with students.

Students should also understand clearly what successful accomplishment of each proposed task looks like. Models of student work from previous years and other exemplars assist students in developing personal learning goals.

Each assessment task should test only those learning outcomes that have been identified to students. This means, for example, that laboratory skills tests need to be devised and marked to gather information about students' laboratory skills, not their ability to express ideas effectively when writing a laboratory report.

### **Effective Assessment Is a Collaborative Process Involving Students**

The ultimate purpose of assessment is to enable students to assess themselves. The gradual increase of student responsibility for assessment is aimed at developing students' autonomy as lifelong learners. Assessment should decrease, rather than foster, students' dependence on teachers' comments for direction in learning and on marks for validation of their accomplishments.

Assessment enhances students' metacognition. It helps them make judgements about their own learning, and provides them with information for goal setting and self-monitoring.

Teachers increase students' responsibility for assessment by

- requiring students to select the products and performances to demonstrate their learning
- involving students in developing assessment criteria whenever possible (This clarifies the goals of a particular assignment and provides students with the vocabulary to discuss their own work.)
- involving students in peer assessment, informally through peer conferences and formally using checklists
- having students use tools for reflection and self-assessment at every opportunity (e.g., self-assessment checklists, journals, identification and selection of goals, self-assessment of portfolio items)
- establishing a protocol for students who wish to challenge a teacher-assigned mark (Formal appeals are valuable exercises in persuasive writing, and provide opportunities for students to examine their performance in light of the assessment criteria.)

### Effective Assessment Is Multi-Dimensional and Uses a Wide Range of Tools and Methods

Assessment in science must recognize the complexity and holistic nature of learning for scientific literacy. To compile a complete profile of each student's progress, teachers gather data using many different means over numerous occasions. Student profiles may involve both students and teachers in data gathering and assessment.

The following chart identifies areas for assessment and some suggested assessment instruments, tools, and methods.

<b>Data-Gathering Profile</b>			
<b>Observation of Processes</b>		<b>Observation of Products and Performances</b>	
Teacher: <ul style="list-style-type: none"> <li>• Checklists</li> <li>• Conferences and interviews</li> <li>• Anecdotal comments and records</li> <li>• Reviews of drafts and revisions</li> <li>• Oral presentations</li> <li>• Rubrics and marking scales</li> </ul>	Students: <ul style="list-style-type: none"> <li>• Journals</li> <li>• Self-assessment instruments and tools (e.g., checklists, rating scales, progress charts)</li> <li>• Peer-assessment instruments and tools (e.g., peer-conference records, rating scales)</li> </ul>	Teacher: <ul style="list-style-type: none"> <li>• Written assignments</li> <li>• Demonstrations</li> <li>• Presentations</li> <li>• Seminars</li> <li>• Projects</li> <li>• Portfolios</li> <li>• Student journals and notebooks</li> <li>• Checklists</li> <li>• Rubrics and marking scales</li> </ul>	Students: <ul style="list-style-type: none"> <li>• Journals</li> <li>• Self-assessment instruments and tools</li> <li>• Peer-assessment instruments and tools</li> <li>• Portfolio analysis</li> </ul>
<b>Classroom Tests</b>		<b>Divisional and Provincial Standards Tests</b>	
Teacher: <ul style="list-style-type: none"> <li>• Paper-and-pencil tests (e.g., teacher-made tests, unit tests, essay-style tests)</li> <li>• Performance tests and simulations</li> <li>• Rubrics and marking scales</li> </ul>	Students: <ul style="list-style-type: none"> <li>• Journals</li> <li>• Self-assessment instruments and tools</li> </ul>	Teacher marker: <ul style="list-style-type: none"> <li>• Rubrics and marking scales</li> </ul>	

### Effective Assessment Focuses on What Students Have Learned and Can Do (Not on What They Have Not Learned or Cannot Do)

Assessment must be equitable; it must offer opportunities for success to every student. Effective assessment demonstrates the knowledge, skills and strategies, and attitudes of each student and the progress the student is making, rather than simply identifying deficits in learning.

To assess what students have learned and can do, teachers need to use a variety of strategies and approaches, such as the following:

- Use a wide range of instruments to assess the multi-dimensional expressions of each student's learning, avoiding reliance upon rote recall or memorization.

- Provide students with opportunities to learn from feedback and to refine their work, recognizing that not every assignment will be successful, nor will it become part of a summative evaluation.
- Examine several pieces of student work in assessing any particular learning outcome to ensure that data collected are valid bases for making generalizations about student learning.
- Develop complete student profiles by using information from both learning-outcome-referenced assessment, which compares a student's performance to predetermined criteria, and self-referenced assessment, which compares a student's performance to her or his prior performance.
- Avoid using assessment for purposes of discipline or classroom control. Ryan, Connell, and Deci found that assessment that is perceived as a tool for controlling student behaviour, meting out rewards and punishments rather than providing feedback on student learning, reduces student motivation.

Students are sometimes assigned a mark of zero for incomplete work. Averaging a zero into the student's mark, however, means the mark no longer communicates accurate information about the student's achievement of science learning outcomes. Unfinished assignments signal personal or motivational problems that need to be addressed in appropriate and alternative ways.

- Allow students, when appropriate and possible, to choose how they will demonstrate their competence.
- Use assessment tools appropriate for assessing individual and unique products, processes, and performances.

### **Managing Classroom Assessment**

Assessment is one of the greatest challenges science teachers face. The practices that make science classrooms vital and effective (promoting student choice, assessing processes, and assessing the subjective aspect of learning) make assessment a complex matter.

Systems and supports that may assist teachers in managing assessment include

- dispensing with ineffectual means of assessment
- using time savers
- sharing the load
- taking advantage of technology
- establishing systems of recording assessment information

A discussion of these suggestions follows.

---

**Managing Classroom Assessment:** Adapted from Assessment-9 to -10 of *Senior 2 English Language Arts: A Foundation for Implementation*. Copyright © 1998 by Manitoba Education and Training.

**Dispensing with Ineffectual Means of Assessment**

Teachers need to question the efficacy, for example, of writing lengthy commentaries on summative assessment of student projects. Detailed comments are best provided as formative assessment (when students can make immediate use of the feedback) and shared orally in conferences (which provide opportunities for student-teacher discussion).

The time spent in assessment needs to be learning time, both for the teacher and the student.

**Using Time Savers**

Many effective assessment tools are time savers. Developing checklists and rubrics is time-consuming; however, well-written rubrics may eliminate the need to write extensive comments, and may mean that student performances can be assessed largely during class time.

**Sharing the Load**

While the ultimate responsibility for assessment rests with the teacher, student self-assessment also provides a wealth of information. Collaborating with students to generate assessment criteria is part of effective instruction. Grade 11 students may develop checklists and keep copies of their own goals in an assessment binder for periodic conferences. Students may be willing to contribute work samples to be used as models in other classes.

Collaborating with other teachers in creating assessment tools saves time and provides opportunities to discuss assessment criteria.

**Taking Advantage of Technology**

Electronic tools (e.g., audiotapes, videotapes, and computer files) can assist teachers in making and recording observations. Word processors allow teachers to save, modify, and reuse task-specific checklists and rubrics.

**Establishing Systems for Recording Assessment Information**

Collecting data from student observations is especially challenging for Senior Years teachers, who may teach several classes of students in a given semester or term. Teachers may want to identify a group of students in each class for observation each week. Binders, card files, and electronic databases are useful for record keeping, as are self-adhesive notes recording brief observations on student files, which can later be transformed into anecdotal reports.

Teachers may also want to develop comprehensive forms for listing the identified learning outcomes, and for recording data.

## Changing Emphases in Assessment

This view of effective assessment in science for Manitoba is reflective of changes in emphases in science education at the national level and is congruent with international changes in science education. The following chart summarizes some of the changes in the *assessment of student learning*, as envisioned in *National Science Education Standards* (National Research Council).

<b>Changing Emphases in Assessment of Student Learning</b>	
The <i>National Science Education Standards</i> envision change throughout the system. The assessment standards encompass the following changes in emphases:	
<b>Less Emphasis On</b>	<b>More Emphasis On</b>
Assessing what is easily measured	Assessing what is most highly valued
Assessing discrete knowledge	Assessing rich, well-structured knowledge
Assessing scientific knowledge	Assessing scientific understanding and reasoning
Assessing to learn what students do not know	Assessing to learn what students do understand
Assessing only achievement	Assessing achievement and opportunity to learn
End-of-term assessments by teachers	Students engaged in ongoing assessment of their work and that of others
Development of external assessment by measurements experts alone	Teachers involved in the development of external assessments

**Changing Emphases in Assessment of Student Learning:** Reprinted with permission from *National Science Education Standards*. Copyright © 1996 by the National Academy of Sciences, courtesy of the National Academies Press, Washington, DC.

## Types of Assessment

Assessment can be formative, summative, or diagnostic:

- **Formative assessment** is given during the instructional unit and provides students and teachers with information about students' progress in accomplishing identified learning outcomes. Formative assessment also evaluates the effectiveness of instructional programming content, methods, sequence, and pace.
- **Summative assessment** (evaluation) is based on an interpretation of the assessment information collected and is given at the end of an instructional unit. It helps determine the extent of each student's achievement of identified learning outcomes. Evaluation should be based on a variety of assessment information. Summative assessment is used primarily to measure student achievement, to report to parent(s) or guardian(s), students, and other stakeholders, or to measure the effectiveness of instructional programming.
- **Diagnostic assessment** is given before instruction and determines student understanding of topics before learning takes place.

## Assessment Strategies

A range of assessment strategies can be used in the chemistry classroom, including those described below. The same strategy can be used for both formative and summative assessment, depending on the purpose of the assessment. Teachers are encouraged to develop their own assessment for Senior Years science based on their students' learning requirements and the identified student learning outcomes.

- **Observation:** Observation of students is an integral part of the assessment process. It is most effective when focused on skills, concepts, and attitudes. Making brief notes on index cards, self-adhesive notes, or grids, as well as keeping checklists, helps teachers maintain records of continuous progress and achievement.
- **Interviews:** Interviews allow teachers to assess an individual's understanding and achievement of the student learning outcome(s). Interviews provide students with opportunities to model and explain their understandings. Interviews may be formal and informal. Posing science-related questions during planned interviews enables teachers to focus on individual student skills and attitudes. Students reveal their thinking processes and use of skills and strategies when they are questioned about how they solved problems or answered science questions. Using a prepared set of questions ensures that all interviews follow a similar structure. It is important to keep a record of student responses and/or understandings.
- **Group/peer assessment:** Group assessment gives students opportunities to assess how well they work within a group. Peer assessment gives them opportunities to reflect on one another's work, according to clearly established criteria. During the peer-assessment process, students must reflect on their own understanding in order to evaluate the performance of another student.

---

**Types of Assessment:** Reprinted from pages 48-50 of *Senior 2 Science: A Foundation for Implementation*. Copyright © 2003 by Manitoba Education and Youth.

- **Self-assessment:** Self-assessment is vital to all learning and, therefore, integral to the assessment process. Each student should be encouraged to assess her or his own work. Students apply known criteria and expectations to their work and reflect on results to determine their progress toward the mastery of a specific learning outcome. Participation in setting self-assessment criteria and expectations helps students to see themselves as scientists and problem solvers. It is important that teachers model the self-assessment process before expecting students to assess themselves.
- **Science journal entries:** Science journal writing provides students with opportunities to reflect on their learning and to demonstrate their understanding using pictures, labelled drawings, and words. These journal entries can be powerful tools of formative assessment, allowing teachers to gauge a student's depth of understanding.
- **Rubrics/checklists:** Rubrics and checklists are tools that identify the criteria upon which student processes, performances, or products will be assessed. They also describe the qualities of work at various levels of proficiency for each criterion. Rubrics and checklists may be developed in collaboration with students.
- **Visual displays:** When individuals or groups of students prepare visual displays, they are involved in processing information and producing a knowledge framework. The completed work (e.g., poster, concept map, diagram, model) is the product with which teachers can determine what their students are thinking.
- **Laboratory reports:** Laboratory reports allow teachers to gauge the ability of students to observe, record, and interpret experimental results. These tools can aid teachers in determining how well students understand the content.
- **Pencil-and-paper tasks:** Quizzes can be used as discrete assessment tools, and tests can be larger assessment experiences. These written tasks may include items such as multiple-choice questions, completion of a drawing or labelled diagram, problem solving, or long-answer questions. Ensure that both restricted and extended expository responses are included in these assessment devices.
- **Research reports/presentations:** Research projects allow students to achieve the learning outcomes in individual ways. Assessment should be built into the project at every stage, from planning, to researching, to presenting the finished product.
- **Performance assessment/student demonstrations:** Performance tasks provide students with opportunities to demonstrate their knowledge, thinking processes, and skill development. The tasks require the application of knowledge and skills related to a group of learning outcomes. Performance-based tests do not test the information students possess, but the way their understanding of a subject has been deepened, and their ability to apply their learning in a simulated performance. A scoring rubric that includes a scale for the performance of the task helps organize and interpret evidence. Rubrics allow for a continuum of performance levels associated with the task being assessed.

### Performance-Based Assessment Approaches

The following performance-based assessment approaches and strategies can be used to assess student knowledge and skills:

- **Interpretation of media reports of science:** Short pieces extracted from newspapers could be used to assess the following: whether pupils understand the scientific content of the piece; whether they can identify and evaluate the possible risks and quality of the evidence presented; whether they can offer well-thought-out reactions to the claims; and, finally, whether they can give their opinions about future action that could be taken by individuals, governments, or other bodies.
- **Demonstration of an understanding of the major explanatory stories of science:** Questions should seek to examine observable results such as the following: whether students have understood, for example, what the particle model of matter is; whether they can give a short account of it; whether they can use it to explain everyday phenomena; and whether they can explain why it is an important idea in science.
- **Asking and answering questions based on data:** Such questions should assess students' abilities to represent data in a variety of ways; to formulate and interpret the messages that can be extracted from data; and to detect errors and dishonesty in the way data are presented or selected. The ability to manipulate and interpret data is a core skill that is of value, not only in science, but also in a wide range of other professions and contexts.
- **Recognizing the role of evidence:** At the heart of scientific rationality is a commitment to evidence. Contemporary science confronts the modern citizen with claims that are contested and uncertain. Questions based on historical or contemporary examples can be used to investigate students' understanding of the role of evidence in resolving competing arguments between differing theoretical accounts.

**Performance-Based Assessment Approaches:** Adapted from Robin Millar and Jonathan Osborne, eds., *Beyond 2000: Science Education for the Future* (London, UK: King's College, 1998) 26. Adapted by permission of the authors.



## NOTES

# SECTION 4:

## DOCUMENT ORGANIZATION

---

Document Organization and Format	3
Guide to Reading the Learning Outcomes and the Document Format	3
Sample Two-Page Layout	6
General Learning Outcomes	8
Cluster 0: Skills and Attitudes Outcomes	10
Specific Learning Outcomes	13



# DOCUMENT ORGANIZATION

---

## Document Organization and Format

The suggestions for instruction and assessment contained within *Grade 11 Chemistry: A Foundation for Implementation* provide teachers with strategies for assisting students in achieving the general and specific learning outcomes identified for this curriculum. The instructional and assessment suggestions offer teachers a range of strategies from which to select appropriate directions with students. Although they are not prescriptive, the strategies presented can be considered starting points from which teachers can include their own initiatives, style, and effective techniques to foster learning.

The topic-related and general appendices found at the end of this document provide additional information on student learning activities, teacher support materials related to instruction and assessment, and a variety of assessment rubrics. These complementary resources are closely linked to the learning outcomes and to the skills and attitudes, and are designed to support, facilitate, and enhance student learning.

At-a-glance listings of the general learning outcomes, skills and attitudes outcomes, and specific learning outcomes for Grade 11 Chemistry are provided at the end of this section of this document, as well as in Appendix 11.

## Guide to Reading the Learning Outcomes and the Document Format

The specific learning outcomes identified for Grade 11 Chemistry are organized according to five “thematic” topics:

- Topic 1: Physical Properties of Matter
- Topic 2: Gases and the Atmosphere
- Topic 3: Chemical Reactions
- Topic 4: Solutions
- Topic 5: Organic Chemistry

The suggested strategies for implementing the curricular outcomes within each chemistry topic include the following components:

- **Specific Learning Outcomes (SLOs):** The SLOs identified in the headers outline the intended learning to be achieved by the student by the end of the course. They include the SLOs related to the particular chemistry topic, in addition to the learning outcomes related to Cluster 0: Skills and Attitudes, selected to correspond to the Suggestions for Instruction.
- **General Learning Outcome (GLO) Connections:** The GLOs, found in the footers, provide links across the entire scope of the Kindergarten to Grade 12 continuum of learning in science. These GLOs provide connections to the Five Foundations for Scientific Literacy that guide all Manitoba science curricula in all science discipline areas.

- **Suggestions for Instruction:** The instructional strategies relate directly to the achievement of the SLOs identified in the headers.
  - **Entry-Level Knowledge:** Students will have prior knowledge in relation to some learning outcomes. Identification of students' entry-level knowledge, where included, links instructors to key areas of the science curriculum from previous years, providing information about where students should be in relation to the present learning outcomes. Prior knowledge activities can then be used to provide students with a rationale about what is to come, or to provide a refreshment of conceptual or procedural knowledge that has lapsed over time.
  - **Student Activities:** Student learning activities are suggested for all learning outcomes. The examples of teacher-facilitated instructional strategies presented in this document are designed to be student-centred, engaging the learner directly in some contextual way.
- **Teacher Notes:** Incorporated throughout the document as needed, these notes provide teachers with definitions and content background (often beyond what students are required to know), planning hints, special-interest material, cautions and safety information, and depth of treatment on certain issues related to the identified learning outcomes.
- **Suggestions for Assessment:** These suggestions offer strategies for assessing students' achievement of the specific learning outcomes.
- **Learning Resources Links:** The links to additional chemistry resources are intended to guide and support instruction, the learning process, and student assessment. While only titles, authors, and page references are provided in the Learning Resources Links for the specific learning outcome(s), the complete bibliographic information is cited below (as well as in the Bibliography of this document). It is important to recognize that new editions of standard texts in the field of chemistry can be expected about every two years – often with minimal changes to content. The editions of learning resources identified in this document include those that were used directly in the preparation of *Grade 11 Chemistry: A Foundation for Implementation*. Teachers are encouraged to seek out newer versions of texts considered as “standards in the field.”

The following resources are cited most frequently in the **Learning Resources Links**.

Brown, Theodore E., H. Eugene LeMay, and Bruce E. Bursten. *Chemistry: The Central Science*. 9th ed. Upper Saddle River, NJ: Pearson Education/Prentice Hall, 2003.

Chang, Raymond. *Chemistry*. 4th ed. Boston, MA: McGraw-Hill Higher Education, 1991.

*CRC Handbook of Chemistry and Physics: A Ready-Reference Book of Chemical and Physical Data*. Cleveland, OH: CRC Press, annual publication.

Davies, Lucille, Maurice Di Giuseppe, Ted Gibb, Milan Sanader, and Angela Vavitsas. *Nelson Chemistry 12: College Preparation*. Ontario Edition. Toronto, ON: Thomson Nelson, 2003.

Dingrando, Laurel, Kathleen (Gregg) Tallman, Nichols Hainen, and Cheryl Wistrom. *Glencoe Chemistry: Matter and Change*. Columbus, OH: Glencoe/McGraw-Hill, 2005.

- Glencoe Chemistry: Matter and Change: CBL Laboratory Manual – Teacher Edition*. Columbus, OH: Glencoe/McGraw-Hill, n.d.
- Glencoe Chemistry: Matter and Change: Laboratory Manual – Teacher Edition*. Columbus, OH: Glencoe/McGraw-Hill, 2005.
- Glencoe Chemistry: Matter and Change: Small-Scale Laboratory Manual – Teacher Edition*. Columbus OH: Glencoe/McGraw-Hill, 2005.
- Holmquist, Dan, and Donald Volz. *Chemistry with Calculators*. Portland, OR: Vernier, n.d. Available online at <<http://www.vernier.com/chemistry/>>.
- . *Chemistry with Computers*. Portland, OR: Vernier, n.d. Available online at <<http://www.vernier.com/chemistry/>>.
- Jenkins, Frank, Hans van Kessel, Lucille Davies, Oliver Lantz, Patricia Thomas, and Dick Tompkins. *Nelson Chemistry 11*. Ontario Edition. Toronto, ON: Nelson Thomson Learning, 2002.
- LeMay, Eugene H., Herbert Beall, Karen M. Robblee, and Douglas C. Brouwer. *Prentice Hall Chemistry: Connections to Our Changing World*. Upper Saddle River, NJ: Pearson Education/Prentice Hall, 2002.
- Manitoba Education and Training. *Senior Years Science Teachers' Handbook: A Teaching Resource*. Winnipeg, MB: Manitoba Education and Training, 1997.
- Mustoe, Frank, Michael P. Jansen, Ted Doram, John Ivanco, Christina Clancy, and Anita Ghazariansteja. *McGraw-Hill Ryerson Chemistry*. Combined Atlantic Edition. Toronto, ON: McGraw-Hill Ryerson, 2004.
- . *McGraw-Hill Ryerson Chemistry 11*. Ontario Edition. Toronto, ON: McGraw-Hill Ryerson, 2001.
- PASCO Scientific. Online Science Experiments: <[http://www.pasco.com/experiments/chemistry/november\\_2001/home.html](http://www.pasco.com/experiments/chemistry/november_2001/home.html)>
- PASCO Scientific. *PASPort Explorations in Chemistry Lab Manual*. Roseville, CA: PASCO, n.d. Available online at <<http://www.pasco.com/hsmanuals/ps2808.html>>.
- Phillips, John S., Victor S. Strozak, and Cheryl Wistrom. *Chemistry: Concepts and Applications*. Columbus, OH: Glencoe/McGraw-Hill, 2005.
- Silberberg, Martin S. *Chemistry: The Molecular Nature of Matter and Change*. Boston, MA: McGraw-Hill Higher Education, 2003.
- Slater, A., and G. Rayner-Canham. *Microscale Chemistry Laboratory Manual*. Reading, MA: Addison-Wesley, 1994.
- van Kessel, Hans, Frank Jenkins, Lucille Davies, Donald Plumb, Maurice Di Giuseppe, Oliver Lanz, and Dick Tompkins. *Nelson Chemistry 12*. Ontario Edition. Toronto, ON: Thomson Nelson, 2003.
- Vernier Software and Technology. *Chemistry*. <<http://www.vernier.com/chemistry/>>
- Wilbraham, Antony C., Dennis D. Staley, Michael S. Matta, and Edward L. Waterman. *Prentice Hall Chemistry*. Upper Saddle River, NJ: Pearson Prentice Hall, 2005.
- Zumdahl, Steven S. *Introductory Chemistry: A Foundation*. 4th ed. Boston, MA: Houghton Mifflin, 2004.
- Zumdahl, Steven S., and Susan A. Zumdahl. *Chemistry*. 6th ed. Boston, MA: Houghton Mifflin, 2003.
- Note:** For information on selecting learning resources for Grade 11 and Grade 12 Chemistry, see the Manitoba Education, Citizenship and Youth website at: <<http://www.edu.gov.mb.ca/k12/learnres/bibliographies.html>>.

## Sample Two-Page Layout

The following clarification on reading the document format is based on a sample two-page layout from *Grade 11 Chemistry: A Foundation for Implementation*.

GRADE 11 CHEMISTRY • Topic 5: Organic Chemistry

---

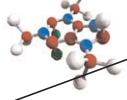

**SPECIFIC LEARNING OUTCOME**  
**C11-5-07:** Name, draw, and construct structural models of isomers for alkanes up to six-carbon atoms.  
 Include: condensed structural formulas

(0.5 hour)

---

SLO: C11-5-07

**SUGGESTIONS FOR INSTRUCTION**

**Entry-Level Knowledge**  
 Students are not expected to have any entry-level knowledge other than their current knowledge of organic IUPAC nomenclature.

**TEACHER NOTES**  
 Students should build these molecular models using techniques similar to those used for the previous learning outcome (C11-5-06).  
  
*Structural isomers* are compounds having the same molecular formula, C<sub>5</sub>H<sub>12</sub>, but a different structural formula.

*Example:*

<i>n</i> -pentane	CH <sub>3</sub> CH <sub>2</sub> CH <sub>2</sub> CH <sub>2</sub> CH <sub>3</sub>
2-methylbutane	$\begin{array}{c} \text{CH}_3\text{CHCH}_2\text{CH}_3 \\   \\ \text{CH}_3 \end{array}$
2,2-dimethylpropane	$\begin{array}{c} \text{CH}_3 \\   \\ \text{CH}_3\text{CCH}_3 \\   \\ \text{CH}_3 \end{array}$

---

**General Learning Outcome Connections**

**GLO B1:** Describe scientific and technological developments—past and present—and appreciate their impact on individuals, societies, and the environment, both locally and globally.

**GLO B2:** Recognize that scientific and technological endeavours have been and continue to be influenced by human needs and the societal context of the time.

**GLO D1:** Understand essential life structures and processes pertaining to a wide variety of organisms, including humans.

**GLO D3:** Understand the properties and structures of matter, as well as various common manifestations and applications of the actions and interactions of matter.

**GLO E1:** Describe and appreciate the similarity and diversity of forms, functions, and patterns within the natural and constructed world.

---

22 - Topic 5: Organic Chemistry

**Icon indicates chemistry topic.**

**Specific learning outcome (SLO) statements define what students are expected to achieve by the end of Grade 11 Chemistry.**

**The first alpha-numeric code indicates course (Grade 11 Chemistry); second digit indicate topic number; and third digit(s) indicate(s) specific learning outcome number.**

**Suggested instructional time allotment for treatment of the specific learning outcome(s).**

**Suggestions for student learning experiences relate directly to the attainment of the specific learning outcome(s).**

**Notes provide teachers with background information, definitions, planning hints, special-interest material, and depth of treatment on certain issues. Safety information and cautions are often included.**

**Include: Indicates a mandatory component of the specific learning outcome, or a defined set of limitations.  
 Examples: Provide ideas of what could be included (non-mandatory). No examples occur in this learning outcome.**

**General learning outcome (GLO) statements connect learning to the Manitoba Foundations for Scientific Literacy.**

Skills and attitudes learning outcomes define expectations across all topics in Grade 11 Chemistry.

## GRADE 11 CHEMISTRY • Topic 5: Organic Chemistry

**SKILLS AND ATTITUDES OUTCOME**

**C11-O-U1:** Use appropriate strategies and skills to develop an understanding of chemical concepts.

*Examples: analogies, concept frames, concept maps, manipulatives, particulate representations, role-plays, simulations, sort-and-predict frames, word cycles...*

Structural isomers will have the same molar mass but differing physical and chemical properties. The number of isomers that are possible for a given molecular formula increases rapidly with the number of carbon atoms.

Number of Carbon Atoms	Number of Isomers
4	2
5	3
6	5
10	75
40	62,491,178,805,831

**Activity**

Have students try to draw all the possible structures for heptane,  $C_7H_{16}$ . That should keep them busy for a while!

While other kinds of isomerism (beyond structural) could be addressed, they are not discussed in Grade 11 Chemistry (they are reserved for advanced-level study).

**SUGGESTION FOR ASSESSMENT****Paper-and-Pencil Task**

Students should be able to use an example to illustrate and explain isomers.

**LEARNING RESOURCES LINKS**

*Chemistry* (Chang 981)  
*Chemistry* (Zumdahl and Zumdahl 1045)  
*Chemistry: The Central Science* (Brown, et al. 988)  
*Chemistry: Concepts and Applications* (Phillips, Strozak, and Wistrom 628)  
*Chemistry: The Molecular Nature of Matter and Change* (Silberberg 623)  
*Glencoe Chemistry: Matter and Change* (Dingrando, et al. 717)  
*Introductory Chemistry: A Foundation* (Zumdahl 579)  
*McGraw-Hill Ryerson Chemistry, Combined Atlantic Edition* (Mustoe, et al. 326)  
*McGraw-Hill Ryerson Chemistry 11, Ontario Edition* (Mustoe, et al. 539)  
*Nelson Chemistry 11, Ontario Edition* (Jenkins, et al. 529)  
*Nelson Chemistry 12, Ontario Edition* (van Kessel, et al. 13, 814)  
*Prentice Hall Chemistry: Connections to Our Changing World* (LeMay, et al. 820)

Suggested strategies relate directly to assessing student achievement of the specific learning outcome(s).

Links indicate the titles, authors, and page references (or URLs) where SLO-related content is treated within the various learning resources.



## General Learning Outcomes

General learning outcomes (GLOs) provide connections to the Five Foundations for Scientific Literacy that guide all Manitoba science curricula in all science discipline areas.

### Nature of Science and Technology

As a result of their Senior Years science education, students will:

- A1** Recognize both the power and limitations of science as a way of answering questions about the world and explaining natural phenomena.
  - A2** Recognize that scientific knowledge is based on evidence, models, and explanations, and evolves as new evidence appears and new conceptualizations develop.
  - A3** Distinguish critically between science and technology in terms of their respective contexts, goals, methods, products, and values.
  - A4** Identify and appreciate contributions made by women and men from many societies and cultural backgrounds that have increased our understanding of the world and brought about technological innovations.
  - A5** Recognize that science and technology interact with and advance one another.
- 

### Science, Technology, Society, and the Environment (STSE)

As a result of their Senior Years science education, students will:

- B1** Describe scientific and technological developments—past and present—and appreciate their impact on individuals, societies, and the environment, both locally and globally.
  - B2** Recognize that scientific and technological endeavours have been and continue to be influenced by human needs and the societal context of the time.
  - B3** Identify the factors that affect health, and explain the relationships among personal habits, lifestyle choices, and human health, both individual and social.
  - B4** Demonstrate knowledge of and personal consideration for a range of possible science- and technology-related interests, hobbies, and careers.
  - B5** Identify and demonstrate actions that promote a sustainable environment, society, and economy, both locally and globally.
-

**Scientific and Technological Skills and Attitudes**

As a result of their Senior Years science education, students will:

- C1 Recognize safety symbols and practices related to scientific and technological activities and to their daily lives, and apply this knowledge in appropriate situations.
  - C2 Demonstrate appropriate scientific inquiry skills when seeking answers to questions.
  - C3 Demonstrate appropriate problem-solving skills when seeking solutions to technological challenges.
  - C4 Demonstrate appropriate critical thinking and decision-making skills when choosing a course of action based on scientific and technological information.
  - C5 Demonstrate curiosity, skepticism, creativity, open-mindedness, accuracy, precision, honesty, and persistence, and appreciate their importance as scientific and technological habits of mind.
  - C6 Employ effective communication skills and use information technology to gather and share scientific and technological ideas and data.
  - C7 Work cooperatively and value the ideas and contributions of others while carrying out scientific and technological activities.
  - C8 Evaluate, from a scientific perspective, information and ideas encountered during investigations and in daily life.
- 

**Essential Science Knowledge**

As a result of their Senior Years science education, students will:

- D1 Understand essential life structures and processes pertaining to a wide variety of organisms, including humans.
  - D2 Understand various biotic and abiotic components of ecosystems, as well as their interaction and interdependence within ecosystems and within the biosphere as a whole.
  - D3 Understand the properties and structures of matter, as well as various common manifestations and applications of the actions and interactions of matter.
  - D4 Understand how stability, motion, forces, and energy transfers and transformations play a role in a wide range of natural and constructed contexts.
  - D5 Understand the composition of the Earth's atmosphere, hydrosphere, and lithosphere, as well as the processes involved within and among them.
  - D6 Understand the composition of the universe, the interactions within it, and the implications of humankind's continued attempts to understand and explore it.
-

### Unifying Concepts

As a result of their Senior Years science education, students will:

- E1** Describe and appreciate the similarity and diversity of forms, functions, and patterns within the natural and constructed world.
  - E2** Describe and appreciate how the natural and constructed world is made up of systems and how interactions take place within and among these systems.
  - E3** Recognize that characteristics of materials and systems can remain constant or change over time, and describe the conditions and processes involved.
  - E4** Recognize that energy, whether transmitted or transformed, is the driving force of both movement and change, and is inherent within materials and in the interactions among them.
- 

### Cluster 0: Skills and Attitudes Outcomes

In Grade 11 Chemistry, Cluster 0 comprises four categories of specific learning outcomes that describe the skills and attitudes involved in scientific inquiry and the decision-making process for Science, Technology, Society, and the Environment (STSE) issues. From Grades 5 to 10, students develop scientific inquiry through the development of a hypothesis/prediction, the identification and treatment of variables, and the formation of conclusions. Students begin to make decisions based on scientific facts and refine their decision-making skills as they progress through the grades, gradually becoming more independent. Students also develop key attitudes, an initial awareness of the nature of science, and other skills related to research, communication, the use of information technology, and cooperative learning.

In Grade 11 Chemistry, students continue to use scientific inquiry as an important process in their science learning, but also recognize that STSE issues require a more sophisticated treatment through the decision-making process.

Teachers should select appropriate contexts to introduce and reinforce scientific inquiry, the decision-making process, and positive attitudes within the thematic topics (Topics 1 to 5) throughout the school year. To assist in planning and to facilitate curricular integration, many specific learning outcomes within the Skills and Attitudes cluster can link to specific learning outcomes in other subject areas.

### Demonstrating Understanding

**C11-0-U1** Use appropriate strategies and skills to develop an understanding of chemical concepts.

*Examples: analogies, concept frames, concept maps, manipulatives, particulate representations, role-plays, simulations, sort-and-predict frames, word cycles...*

**C11-0-U2** Demonstrate an understanding of chemical concepts.

*Examples: use accurate scientific vocabulary, explain concepts to others, compare and contrast concepts, apply knowledge to new situations and/or contexts, create analogies, use manipulatives...*

---

**Scientific Inquiry**

- C11-0-S1** Demonstrate work habits that ensure personal safety and the safety of others, as well as consideration for the environment.  
Include: knowledge and use of relevant safety precautions, Workplace Hazardous Materials Information System (WHMIS), emergency equipment
- C11-0-S2** State a testable hypothesis or prediction based on background data or on observed events.
- C11-0-S3** Design and implement an investigation to answer a specific scientific question.  
Include: materials, independent and dependent variables, controls, methods, safety considerations
- C11-0-S4** Select and use scientific equipment appropriately and safely.  
*Examples: volumetric glassware, balance, thermometer...*
- C11-0-S5** Collect, record, organize, and display data using an appropriate format.  
*Examples: labelled diagrams, graphs, multimedia applications, software integration, probeware...*
- C11-0-S6** Estimate and measure accurately using Système International (SI) and other standard units.  
Include: SI conversions, significant figures
- C11-0-S7** Interpret patterns and trends in data, and infer and explain relationships.
- C11-0-S8** Evaluate data and data-collection methods for accuracy and precision.  
Include: discrepancies in data, sources of error, percent error
- C11-0-S9** Draw a conclusion based on the analysis and interpretation of data.  
Include: cause-and-effect relationships, alternative explanations, supporting or rejecting a hypothesis or prediction
- 

**Research**

- C11-0-R1** Synthesize information obtained from a variety of sources.  
Include: print and electronic sources, specialists, other resource people
- C11-0-R2** Evaluate information obtained to determine its usefulness for information needs.  
*Examples: scientific accuracy, reliability, currency, relevance, balance of perspectives, bias...*
- C11-0-R3** Quote from or refer to sources as required and reference information sources according to an accepted practice.
- C11-0-R4** Compare diverse perspectives and interpretations in the media and other information sources.
- C11-0-R5** Communicate information in a variety of forms appropriate to the audience, purpose, and context.
-

### **Communication and Teamwork**

**C11-0-C1** Collaborate with others to achieve group goals and responsibilities.

**C11-0-C2** Elicit, clarify, and respond to questions, ideas, and diverse points of view in discussions.

**C11-0-C3** Evaluate individual and group processes.

---

### **Decision Making**

**C11-0-D1** Identify and explore a current STSE issue.

*Examples: clarify what the issue is, identify different viewpoints and/or stakeholders, research existing data/information...*

**C11-0-D2** Evaluate implications of possible alternatives or positions related to an STSE issue.

*Examples: positive and negative consequences of a decision, strengths and weaknesses of a position...*

**C11-0-D3** Recognize that decisions reflect values and consider their own values and those of others when making a decision.

*Examples: being in balance with nature, generating wealth, respecting personal freedom...*

**C11-0-D4** Recommend an alternative or identify a position and provide justification.

**C11-0-D5** Propose a course of action related to an STSE issue.

**C11-0-D6** Reflect on the process used by self or others to arrive at an STSE decision.

---

### **Attitudes**

**C11-0-A1** Demonstrate confidence in their ability to carry out investigations in chemistry and to address STSE-related issues.

**C11-0-A2** Value skepticism, honesty, accuracy, precision, perseverance, and open-mindedness as scientific and technological habits of mind.

**C11-0-A3** Demonstrate a continuing, increasingly informed interest in chemistry and chemistry-related careers and issues.

**C11-0-A4** Be sensitive and responsible in maintaining a balance between the needs of humans and a sustainable environment.

---

## Specific Learning Outcomes

The specific learning outcomes (SLOs) identified here constitute the intended learning to be achieved by the student by the end of Grade 11 Chemistry. These statements clearly define what students are expected to achieve and/or be able to perform at the end of course. These SLOs, combined with the Skills and Attitudes SLOs, constitute the source upon which assessment and instructional design are based.

### Topic 1: Physical Properties of Matter

- C11-1-01** Describe the properties of gases, liquids, solids, and plasma.  
Include: density, compressibility, diffusion
- C11-1-02** Use the Kinetic Molecular Theory to explain properties of gases.  
Include: random motion, intermolecular forces, elastic collisions, average kinetic energy, temperature
- C11-1-03** Explain the properties of liquids and solids using the Kinetic Molecular Theory.
- C11-1-04** Explain the process of melting, solidification, sublimation, and deposition in terms of the Kinetic Molecular Theory.  
Include: freezing point, exothermic, endothermic
- C11-1-05** Use the Kinetic Molecular Theory to explain the processes of evaporation and condensation.  
Include: intermolecular forces, random motion, volatility, dynamic equilibrium
- C11-1-06** Operationally define vapour pressure in terms of observable and measurable properties.
- C11-1-07** Operationally define normal boiling point temperature in terms of vapour pressure.
- C11-1-08** Interpolate and extrapolate the vapour pressure and boiling temperature of various substances from pressure versus temperature graphs.
- 

### Topic 2: Gases and the Atmosphere

- C11-2-01** Identify the abundances of the naturally occurring gases in the atmosphere and examine how these abundances have changed over geologic time.  
Include: oxygenation of Earth's atmosphere, the role of biota in oxygenation, changes in carbon dioxide content over time
- C11-2-02** Research Canadian and global initiatives to improve air quality.
- C11-2-03** Examine the historical development of the measurement of pressure.  
*Examples: the contributions of Galileo Galilei, Evangelista Torricelli, Otto von Guericke, Blaise Pascal, Christiaan Huygens, John Dalton, Joseph Louis Gay-Lussac, Amadeo Avogadro...*

- C11-2-04** Describe the various units used to measure pressure.  
Include: atmospheres (atm), kilopascals (kPa), millimetres of mercury (mmHg), millibars (mb)
- C11-2-05** Experiment to develop the relationship between the pressure and volume of a gas using visual, numeric, and graphical representations.  
Include: historical contributions of Robert Boyle
- C11-2-06** Experiment to develop the relationship between the volume and temperature of a gas using visual, numeric, and graphical representations.  
Include: historical contributions of Jacques Charles, the determination of absolute zero, the Kelvin temperature scale
- C11-2-07** Experiment to develop the relationship between the pressure and temperature of a gas using visual, numeric, and graphical representations.  
Include: historical contributions of Joseph Louis Gay-Lussac
- C11-2-08** Solve quantitative problems involving the relationships among the pressure, temperature, and volume of a gas using dimensional analysis.  
Include: symbolic relationships
- C11-2-09** Identify various industrial, environmental, and recreational applications of gases.  
*Examples: self-contained underwater breathing apparatus (scuba), anaesthetics, air bags, acetylene welding, propane appliances, hyperbaric chambers...*
- 

### **Topic 3: Chemical Reactions**

- C11-3-01** Determine average atomic mass using isotopes and their relative abundance.  
Include: atomic mass unit (amu)
- C11-3-02** Research the importance and applications of isotopes.  
*Examples: nuclear medicine, stable isotopes in climatology, dating techniques...*
- C11-3-03** Write formulas and names for polyatomic compounds using International Union of Pure and Applied Chemistry (IUPAC) nomenclature.
- C11-3-04** Calculate the mass of compounds in atomic mass units.
- C11-3-05** Write and classify balanced chemical equations from written descriptions of reactions.  
Include: polyatomic ions
- C11-3-06** Predict the products of chemical reactions, given the reactants and type of reaction.  
Include: polyatomic ions

- C11-3-07** Describe the concept of the mole and its importance to measurement in chemistry.
- C11-3-08** Calculate the molar mass of various substances.
- C11-3-09** Calculate the volume of a given mass of a gaseous substance from its density at a given temperature and pressure.  
Include: molar volume calculation
- C11-3-10** Solve problems requiring interconversions between moles, mass, volume, and number of particles.
- C11-3-11** Determine empirical and molecular formulas from percent composition or mass data.
- C11-3-12** Interpret a balanced equation in terms of moles, mass, and volumes of gases.
- C11-3-13** Solve stoichiometric problems involving moles, mass, and volume, given the reactants and products in a balanced chemical reaction.  
Include: heat of reaction problems
- C11-3-14** Identify the limiting reactant and calculate the mass of a product, given the reaction equation and reactant data.
- C11-3-15** Perform a lab involving mass-mass or mass-volume relations, identifying the limiting reactant and calculating the mole ratio.  
Include: theoretical yield, experimental yield
- C11-3-16** Discuss the importance of stoichiometry in industry and describe specific applications.  
*Examples: analytical chemistry, chemical engineering, industrial chemistry...*
- 

#### **Topic 4: Solutions**

- C11-4-01** Describe and give examples of various types of solutions.  
Include: all nine possible types
- C11-4-02** Describe the structure of water in terms of electronegativity and the polarity of its chemical bonds.
- C11-4-03** Explain the solution process of simple ionic and covalent compounds, using visual, particulate representations and chemical equations.  
Include: crystal structure, dissociation, hydration
- C11-4-04** Explain heat of solution with reference to specific applications.  
*Examples: cold packs, hot packs...*
- C11-4-05** Perform a lab to illustrate the formation of solutions in terms of the polar and non-polar nature of substances.  
Include: soluble, insoluble, miscible, immiscible



- C11-4-06** Construct, from experimental data, a solubility curve of a pure substance in water.
- C11-4-07** Differentiate among saturated, unsaturated, and supersaturated solutions.
- C11-4-08** Use a graph of solubility data to solve problems.
- C11-4-09** Explain how a change in temperature affects the solubility of gases.
- C11-4-10** Explain how a change in pressure affects the solubility of gases.
- C11-4-11** Perform a lab to demonstrate freezing-point depression and boiling-point elevation.
- C11-4-12** Explain freezing-point depression and boiling-point elevation at the molecular level.  
*Examples: antifreeze, road salt...*
- C11-4-13** Differentiate among, and give examples of, the use of various representations of concentration.  
Include: grams per litre (g/L), % weight-weight (% w/w), % weight-volume (% w/v), % volume/volume (% v/v), parts per million (ppm), parts per billion (ppb), moles per litre (mol/L) (molarity)
- C11-4-14** Solve problems involving calculation for concentration, moles, mass, and volume.
- C11-4-15** Prepare a solution, given the amount of solute (in grams) and the volume of solution (in millilitres), and determine the concentration in moles/litre.
- C11-4-16** Solve problems involving the dilution of solutions.  
Include: dilution of stock solutions, mixing common solutions with different volumes and concentrations
- C11-4-17** Perform a dilution from a solution of known concentration.
- C11-4-18** Describe examples of situations where solutions of known concentration are important.  
*Examples: pharmaceutical preparations, administration of drugs, aquaria, swimming-pool disinfectants, gas mixes for scuba, radiator antifreeze...*
- C11-4-19** Describe the process of treating a water supply, identifying the allowable concentrations of metallic and organic species in water suitable for consumption.
-

**Topic 5: Organic Chemistry**

- C11-5-01** Compare and contrast inorganic and organic chemistry.  
Include: the contributions of Friedrich Wöhler to the overturn of vitalism
- C11-5-02** Identify the origins and major sources of hydrocarbons and other organic compounds.  
Include: natural and synthetic sources
- C11-5-03** Describe the structural characteristics of carbon.  
Include: bonding characteristics of the carbon atom in hydrocarbons (single, double, triple bonds)
- C11-5-04** Compare and contrast the molecular structures of alkanes, alkenes, and alkynes.  
Include: trends in melting points and boiling points of alkanes only
- C11-5-05** Name, draw, and construct structural models of the first 10 alkanes.  
Include: IUPAC nomenclature, structural formulas, condensed structural formulas, molecular formulas, general formula  $C_nH_{(2n+2)}$
- C11-5-06** Name, draw, and construct structural models of branched alkanes.  
Include: six-carbon parent chain, methyl and ethyl substituent groups, IUPAC nomenclature
- C11-5-07** Name, draw, and construct structural models of isomers for alkanes up to six-carbon atoms.  
Include: condensed structural formulas
- C11-5-08** Outline the transformation of alkanes to alkenes and vice versa.  
Include: dehydrogenation/hydrogenation, molecular models
- C11-5-09** Name, draw, and construct molecular models of alkenes and branched alkenes.  
Include: six-carbon parent chain, methyl and ethyl substituent groups, IUPAC nomenclature, structural formulas, condensed structural formulas, molecular formulas, general formula  $C_nH_{2n}$
- C11-5-10** Differentiate between saturated and unsaturated hydrocarbons.
- C11-5-11** Outline the transformation of alkenes to alkynes and vice versa.  
Include: dehydrogenation/hydrogenation, molecular models
- C11-5-12** Name, draw, and construct structural models of alkynes and branched alkynes.  
Include: six-carbon parent chain, methyl and ethyl substituent groups, IUPAC nomenclature, structural formulas, condensed structural formulas, molecular formulas, general formula  $C_nH_{2n-2}$
- C11-5-13** Compare and contrast the structure of aromatic and aliphatic hydrocarbons.  
Include: molecular models, condensed structural formulas

- C11-5-14** Describe uses of aromatic hydrocarbons.  
*Examples: polychlorinated biphenyls, caffeine, steroids, organic solvents (toluene, xylene)...*
- C11-5-15** Write condensed structural formulas for and name common alcohols.  
Include: maximum of six-carbon parent chain, IUPAC nomenclature
- C11-5-16** Describe uses of methyl, ethyl, and isopropyl alcohols.
- C11-5-17** Write condensed structural formulas for and name organic acids.  
Include: maximum of six-carbon parent chain, IUPAC nomenclature
- C11-5-18** Describe uses or functions of common organic acids.  
*Examples: acetic, ascorbic, citric, formic, acetylsalicylic (ASA), lactic...*
- C11-5-19** Perform a lab involving the formation of esters, and examine the process of esterification.
- C11-5-20** Write condensed structural formulas for and name esters.  
Include: up to 6-C alcohols and 6-C organic acids, IUPAC nomenclature
- C11-5-21** Describe uses of common esters.  
*Examples: pheromones, artificial flavourings...*
- C11-5-22** Describe the process of polymerization and identify important natural and synthetic polymers.  
*Examples: polyethylene, polypropylene, polystyrene, polytetrafluoroethylene (Teflon®)...*
- C11-5-23** Describe how the products of organic chemistry have influenced quality of life.  
*Examples: synthetic rubber, nylon, medicines, polytetrafluoroethylene (Teflon®)...*
- C11-5-24** Use the decision-making process to investigate an issue related to organic chemistry.  
*Examples: gasohol production, alternative energy sources, recycling of plastics...*
-

# GRADE 11 CHEMISTRY

---

Topic 1: Physical Properties of Matter

Topic 2: Gases and the Atmosphere

Topic 3: Chemical Reactions

Topic 4: Solutions

Topic 5: Organic Chemistry



**TOPIC 1:**  
**PHYSICAL PROPERTIES OF MATTER**

---

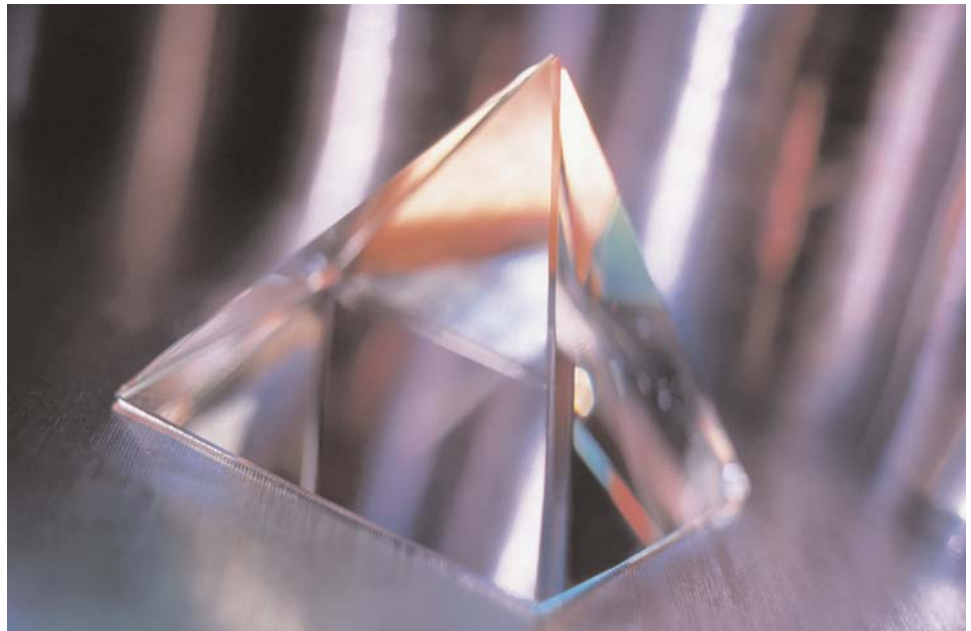



## Topic 1: Physical Properties of Matter

- C11-1-01** Describe the properties of gases, liquids, solids, and plasma.  
Include: density, compressibility, diffusion
- C11-1-02** Use the Kinetic Molecular Theory to explain properties of gases.  
Include: random motion, intermolecular forces, elastic collisions, average kinetic energy, temperature
- C11-1-03** Explain the properties of liquids and solids using the Kinetic Molecular Theory.
- C11-1-04** Explain the process of melting, solidification, sublimation, and deposition in terms of the Kinetic Molecular Theory.  
Include: freezing point, exothermic, endothermic
- C11-1-05** Use the Kinetic Molecular Theory to explain the processes of evaporation and condensation.  
Include: intermolecular forces, random motion, volatility, dynamic equilibrium
- C11-1-06** Operationally define vapour pressure in terms of observable and measurable properties.
- C11-1-07** Operationally define normal boiling point temperature in terms of vapour pressure.
- C11-1-08** Interpolate and extrapolate the vapour pressure and boiling temperature of various substances from pressure versus temperature graphs.

**Suggested Time: 10.0 hours**

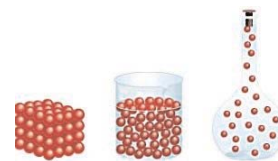



**SPECIFIC LEARNING OUTCOME**

**C11-1-01:** Describe the properties of gases, liquids, solids, and plasma.

Include: density, compressibility, diffusion

(2.0 hours)

SLO: C11-1-01

**SUGGESTIONS FOR INSTRUCTION****Entry-Level Knowledge**

In Grade 7 Science, students were introduced to the particle theory of matter to explain changes of state. The discussion included the absorption or release of energy. Students were also introduced to heating and cooling curves. In Grade 8 Science, students conducted extensive investigations on the properties of fluids, including viscosity, pressure, compressibility, and hydraulics.

**Assessing Prior Knowledge**

Check for student understanding of prior knowledge and review as necessary. Prior knowledge can be reviewed and/or assessed by using any of the KWL (Know, Want to know, Learned) strategies (e.g., Concept Map, Knowledge Chart, Think-Pair-Share) found in Chapter 9 of *Senior Years Science Teachers' Handbook* (Manitoba Education and Training)—hereafter referred to as *SYSTH*.

**TEACHER NOTES**

All the specific learning outcomes in Topic 1 of Grade 11 Chemistry are closely connected to the particulate nature of matter. Review the outcomes, as well as the instructional and assessment suggestions, before starting instruction.

Most students are familiar with three of the four states of matter (i.e., gases, liquids, and solids) through the observations they make in their daily lives. To understand the development of the kinetic molecular model, however, students should review the differences in the states of matter and the processes required to interchange them. If time permits, have students melt, boil, and condense water using observations to discuss the properties of the more common states of matter (e.g., density, volume, shape, compressibility, diffusion). If experimental evidence is not possible, then ask students to recall observations from their past experience and

**General Learning Outcome Connections**

- GLO C6:** Employ effective communication skills and use information technology to gather and share scientific and technological ideas and data.
- GLO C7:** Work cooperatively and value the ideas and contributions of others while carrying out scientific and technological activities.
- GLO C8:** Evaluate, from a scientific perspective, information and ideas encountered during investigations and in daily life.
- GLO D3:** Understand the properties and structures of matter, as well as various common manifestations and applications of the actions and interactions of matter.

**SKILLS AND ATTITUDES OUTCOMES**

**C11-0-R1:** Synthesize information obtained from a variety of sources.

Include: print and electronic sources, specialists, other resource people

**C11-0-U1:** Use appropriate strategies and skills to develop an understanding of chemical concepts.

Examples: analogies, concept frames, concept maps, manipulatives, particulate representations, role-plays, simulations, sort-and-predict frames, word cycles...

knowledge (e.g., boiling water on the stove, sublimation of solid water from washing in sub-zero weather, melting and solidification of candle wax, evaporation of acetone from hands).

Most resources provide a good explanation of the physical characteristics of the most common three states of matter: *gases*, *liquids*, and *solids*. The fourth state, *plasma*, can be simply defined as a gaseous mixture of positive ions and electrons. Due to the unstable nature of these particles, the only way to have a large number of these energetic particles coexisting is at temperatures over 100 million degrees Celsius. The challenge for engineers is to contain high-energy plasmas once they are created (Chang 964).

Plasmas are the most common form of matter in the universe, comprising 99% of the visible universe, but are the least common on Earth. Examples include the aurora borealis, lightning, stars, fluorescent lights, and plasma TVs.

**Discrepant Event Activities**

Discrepant events provide opportunities to illustrate some of the physical properties of the three states of matter. It is not intended that all activities suggested below be done. Select activities and demonstrations appropriate for the class.

1. Add water to the  $\frac{3}{4}$  mark in a eudiometer tube, and then add ethanol to fill the tube completely. Seal the tube and mix contents by carefully inverting the tube. Have students observe the change in volume and explain what they see.
2. **Demonstrating Diffusion on an Overhead Projector** (see Appendix 1.1): Sprinkle a few crystals of paradichlorobenzene into one compartment of a four-quadrant petri dish and a few crystals of iodine into the opposite compartment. Place the petri dish on an overhead projector stage. Add 1 or 2 mL of acetone to one of the remaining quadrants of the petri dish and cover it with the supplied top. Have students observe, record, and explain what happens.
3. **A “Real” Water Fountain** (see Appendix 1.2): Heat a small quantity of water in a 1 L Florence flask to displace the air. When the flask is filled with water vapour or steam, stop the heating. Note that the steam condenses and the pressure inside the flask drops. Cold water from the beaker is then pushed into the flask by atmospheric pressure, with dramatic results. (See diagram.) This event could be used to address learning outcomes C11-2-03 and C11-2-04 and atmospheric pressure.

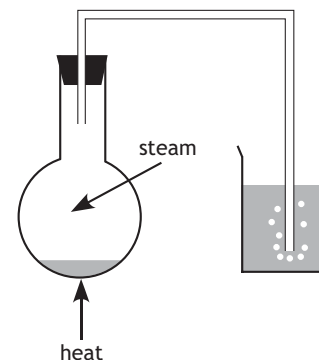

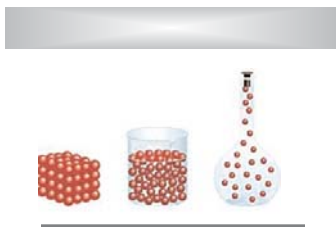
**SPECIFIC LEARNING OUTCOME****C11-1-01:** Describe the properties of gases, liquids, solids, and plasma.

Include: density, compressibility, diffusion

*(continued)***Particulate Activities****Solids**

The motion of particles in a solid can be demonstrated by placing a one metre by one metre square of tape on the floor and having nine student volunteers try to move around in the square. Students should find that their motion is limited to “bumping” into each other.

**Liquids**

The motion of particles in a liquid can be demonstrated using marbles. Spread out the marbles evenly to fill the bottom of a container. The volume they occupy cannot be reduced. When the container is swirled and tipped, the marbles flow out onto a table.

**Gases**

1. The motion of particles in a gas can be demonstrated using an air hockey puck and table. The puck travels in a straight line until it hits the side of the board, and then rebounds in a straight line in a new direction.
2. Use effervescent tablets, water, and a candle to show that a gas can be poured. Alternatively, place dry ice into warm water so that students can “watch” the cooled carbon dioxide vapour fall to the floor.

**Activities/Demonstrations**

It is not intended that all activities/demonstrations be done. Select the activities and demonstrations appropriate for the class.

1. Have students research the densities of a number of metals, liquids, and gases. Ask students to organize them according to densities to illustrate the differences between solids, liquids, and gases. Many websites provide information about the physical properties of elements and compounds. Use the *CRC Handbook of Chemistry and Physics* to find densities.
2. Demonstrate the compressibility of gases using a simple air pump.
3. Put a few drops of any flavouring (e.g., peppermint) into a balloon. Inflate the balloon. Students will be able to smell the flavouring through the rubber as it diffuses through the membrane of the balloon.
4. Open a container of a volatile liquid, such as perfume or butyric acid, somewhere unnoticed in the room and wait for students’ reaction.

**SKILLS AND ATTITUDES OUTCOMES**

**C11-0-R1:** Synthesize information obtained from a variety of sources.

Include: print and electronic sources, specialists, other resource people

**C11-0-U1:** Use appropriate strategies and skills to develop an understanding of chemical concepts.

Examples: analogies, concept frames, concept maps, manipulatives, particulate representations, role-plays, simulations, sort-and-predict frames, word cycles...

---

5. The classical demonstration for quantitative or qualitative diffusion is with ammonium hydroxide and hydrochloric acid. Most textbooks describe a procedure. Basically, a cotton plug soaked with ammonium hydroxide is placed into the end of a 60 cm piece of glass tubing. Another cotton plug soaked with hydrochloric acid is simultaneously placed in the other end of the tube. As the vapours diffuse along the tube, a ring of ammonium chloride is produced where the  $\text{NH}_3$  and  $\text{HCl}$  particles meet. As  $\text{NH}_3$  particles have less mass, the ring of product should be closer to the heavier vapour. (See Dingrando, *et al.* 388.)
- Extension:* By measuring the distance from each plug of cotton to the product formed, a distance ratio can be calculated to establish a relationship between the relative masses of the molecules in question. Using Graham's Law of Diffusion will produce a ratio of 1:5.
6. Have students conduct a heating curve investigation for water to review prior knowledge and to reinforce safety rules in the laboratory. Students could collect data either manually using a thermometer or by using a calculator-based laboratories (CBL) system.
7. **Popping the Kernel: Modelling the States of Matter** (see Appendix 1.3): This simple activity (Hitt, White, and Hanson 39–41) provides students with the opportunity to examine the states and physical properties of matter.

**TEACHER NOTES**

Not all forms of matter can be readily described as solids, liquids, or gases. In the case of liquid crystals, the ability to control the orientation of the molecules contained in the crystals allows industry to produce materials with high strength or unique properties. Liquid crystal displays (LCDs) are used in watches, thermometers, calculators, and laptop computers. (For a discussion of liquid crystals and ceramic materials, see Silberberg 462.)

*Amorphous* (Greek for “without form”) materials have an irregular arrangement of particles. These substances do not have a definite melting point. There are many examples of such materials (e.g., peanut butter, candle wax, cotton candy, glass, rubber, plastic, asphalt). Amorphous carbon is produced from the decomposition of carbon compounds. When animal bones decompose, bone black is produced. It is used as a pigment and in the refining of sugars. The decomposition of coal produces the coke that is used in dry cell batteries.

Teachers may wish to discuss the term *allotropes* – different particle arrangements of the same substance. For example, carbon can exist as tetrahedral crystals (diamond), sheets (graphite), cage-like balls (buckminsterfullerenes), and cage-like tubes (nanotubes).

---

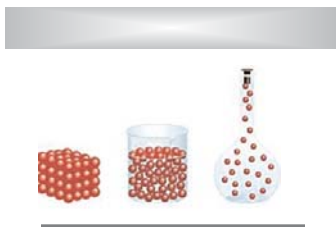

#### SPECIFIC LEARNING OUTCOME

**C11-1-01:** Describe the properties of gases, liquids, solids, and plasma.

Include: density, compressibility, diffusion

(continued)



#### SUGGESTIONS FOR ASSESSMENT

---

##### Research Activity

Have students research and report on plasma TVs, monitors, LCDs, and so on. Use the Rubric for Assessment of Research Skills found in Appendix 10 to assess student work.

##### Knowledge Chart

Provide students with a Knowledge Chart (see *SYSTH* 9.25). Have students complete the chart, including representation of the states of matter.

##### Visual Displays

Have students create models to represent their view of the particles in the four states. Use the Rubric for Assessment of Student Presentation found in Appendix 10 to assess the models.

##### Journal Writing

Many unusual materials are discussed in relation to learning outcome C11-1-01. One of the discussion topics for journal writing might be a commentary on the longevity of plasma TV screens compared to their cost.

#### SKILLS AND ATTITUDES OUTCOMES

**C11-0-R1:** Synthesize information obtained from a variety of sources.

Include: print and electronic sources, specialists, other resource people

**C11-0-U1:** Use appropriate strategies and skills to develop an understanding of chemical concepts.

*Examples: analogies, concept frames, concept maps, manipulatives, particulate representations, role-plays, simulations, sort-and-predict frames, word cycles...*

---

#### LEARNING RESOURCES LINKS

---



*Chemistry* (Chang 434)

*Chemistry* (Zumdahl and Zumdahl 449)

*Chemistry: The Central Science* (Brown, et al. 407)

*Chemistry: Concepts and Applications* (Phillips, Strozak, and Wistrom 339)

*Chemistry: The Molecular Nature of Matter and Change* (Silberberg 419, 462)

*Glencoe Chemistry: Matter and Change* (Dingrando, et al. 384)

*Introductory Chemistry: A Foundation* (Zumdahl 398)

*McGraw-Hill Ryerson Chemistry 11, Ontario Edition* (Mustoe, et al. 417)

*Nelson Chemistry 12, Ontario Edition* (van Kessel, et al. 262)

*Nelson Chemistry 12: College Preparation, Ontario Edition* (Davies, et al. 330)

*Prentice Hall Chemistry: Connections to Our Changing World* (LeMay, et al. 456)

#### Selecting Learning Resources

For additional information on selecting learning resources for Grade 11 and Grade 12 Chemistry, see the Manitoba Education, Citizenship and Youth website at:  
<<http://www.edu.gov.mb.ca/k12/learnres/bibliographies.html>>.



## SPECIFIC LEARNING OUTCOME

**C11-1-02:** Use the Kinetic Molecular Theory to explain properties of gases.

Include: random motion, intermolecular forces, elastic collisions, average kinetic energy, temperature

(1.5 hours)

SLO: C11-1-02

## SUGGESTIONS FOR INSTRUCTION

## Entry-Level Knowledge

As was mentioned for learning outcome C11-1-01, students in earlier grades have been introduced to phases and phase changes in terms of energy transfer and the particle theory of matter.

## TEACHER NOTES

This learning outcome begins to provide an explanation for the existence of particles and the development of a more complete particle model. The Kinetic Molecular Theory was proposed to explain the observable properties of gases. Each chemistry text seems to put a different spin on the theory, as well as variations in the number of postulates.

If gas particles in a container at constant temperature are in constant motion, they must eventually collide with other particles, as well as with the container walls. These particles exert pressure when they collide with the walls of their container. *Pressure* is defined as force per unit area.

Lead students through the following logic:

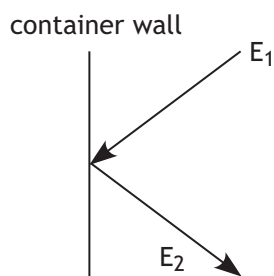

A particle collides with the container wall. Its initial energy is  $E_1$  and its energy after the collision is  $E_2$ .

## General Learning Outcome Connections

- GLO A1:** Recognize both the power and limitations of science as a way of answering questions about the world and explaining natural phenomena.
- GLO A2:** Recognize that scientific knowledge is based on evidence, models, and explanations, and evolves as new evidence appears and new conceptualizations develop.
- GLO D3:** Understand the properties and structures of matter, as well as various common manifestations and applications of the actions and interactions of matter.
- GLO D4:** Understand how stability, motion, forces, and energy transfers and transformations play a role in a wide range of natural and constructed contexts.

**SKILLS AND ATTITUDES OUTCOMES**

**C11-0-U1:** Use appropriate strategies and skills to develop an understanding of chemical concepts.

*Examples: analogies, concept frames, concept maps, manipulatives, particulate representations, role-plays, simulations, sort-and-predict frames, word cycles...*

**C11-0-U2:** Demonstrate an understanding of chemical concepts.

*Examples: use accurate scientific vocabulary, explain concepts to others, compare and contrast concepts, apply knowledge to new situations and/or contexts, create analogies, use manipulatives...*

Three options are possible:

- If  $E_1 > E_2$  then the total energy loss due to all the collisions in the container would result in a pressure drop over time.
- If  $E_1 < E_2$  then the total energy gain of all the collisions would result in a pressure increase.
- If  $E_1 = E_2$  then there would be no loss of energy, the total energy of all the collisions would not change, and the pressure of a gas in a container at a constant temperature would remain constant. A barbecue propane tank is a good example of this phenomenon. If the barbecue is not used, the tank will maintain a constant pressure, provided the temperature is not changed.

For the following two diagrams, the energy of the ball in the first diagram decreases as it collides with the floor, whereas the particle in the second diagram has exactly the same energy after the collision as it did before. These are called *perfectly elastic* or *elastic* collisions.

**Inelastic Collisions** (loss of energy)

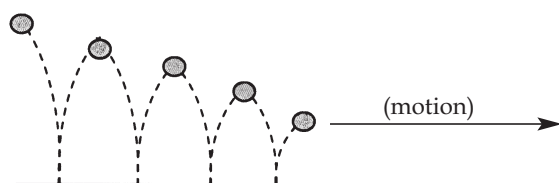

**Elastic Collisions** (no loss of energy)

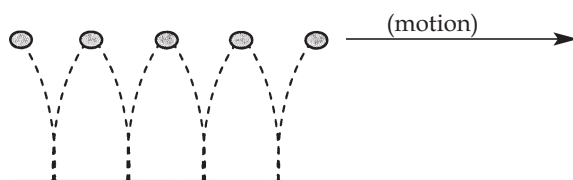

In Grade 11 Chemistry, intermolecular forces should be discussed as general forces and not as three different forces: dipole-dipole forces, London dispersion forces, and hydrogen bonding. A further discussion of intermolecular forces will occur in relation to learning outcomes (C11-1-04, C11-1-05) that address phase changes.

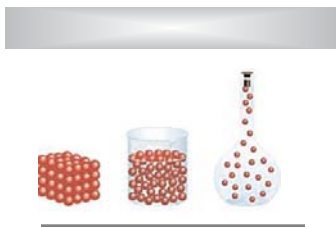

**SPECIFIC LEARNING OUTCOME**

**C11-1-02:** Use the Kinetic Molecular Theory to explain properties of gases.

Include: random motion, intermolecular forces, elastic collisions, average kinetic energy, temperature

(continued)

**Activity/Demonstration**

1. Illustrate the properties of gases with a demonstration. Plug the end of a bicycle pump while pushing in the handle, thereby causing the gas inside the tube to compress.
2. A piece of demonstration equipment called an Atomic Trampoline Kit is available from the Institute for Chemical Education. See *CHEM 13 NEWS* 327 (Feb. 2005): 2.

**Research**

Have students research the three most prominent scientists whose work led to the establishment of the Kinetic Molecular Theory:

- Rudolf Clausius
- James Clerk Maxwell
- Ludwig Boltzmann

Student research could be presented as a written assignment in the form of

- letters between scientists
- bulletin board displays
- technical papers

Graphic representations could include

- diagrams
- posters
- charts

**TEACHER NOTES**

The following diagrams can be found in Appendix 1.4: Kinetic Energy Distribution. The first diagram illustrates how scientists might determine that the particles in a sample of vapour would have a range of speeds. The molten tin vapour is accelerated towards a collimator that produces a narrow beam of particles. The beam is interrupted by a rotating disk  $D_1$  that creates bursts of vapour particles that travel down the evacuated tube towards disk  $D_2$ .

After the disks have rotated many times, the paper attached to  $D_2$  is removed and cut into sections according to the second diagram. The paper slices are carefully massed. The mass of each slice reflects the number of particles landing on each section of the plate. The fastest would land on the sections closer to the slit (i.e., sections 1, 2, 3, etc.).

**SKILLS AND ATTITUDES OUTCOMES**

**C11-0-U1:** Use appropriate strategies and skills to develop an understanding of chemical concepts.

*Examples: analogies, concept frames, concept maps, manipulatives, particulate representations, role-plays, simulations, sort-and-predict frames, word cycles...*

**C11-0-U2:** Demonstrate an understanding of chemical concepts.

*Examples: use accurate scientific vocabulary, explain concepts to others, compare and contrast concepts, apply knowledge to new situations and/or contexts, create analogies, use manipulatives...*

**Rotating disk used to measure atomic or molecular velocities.**

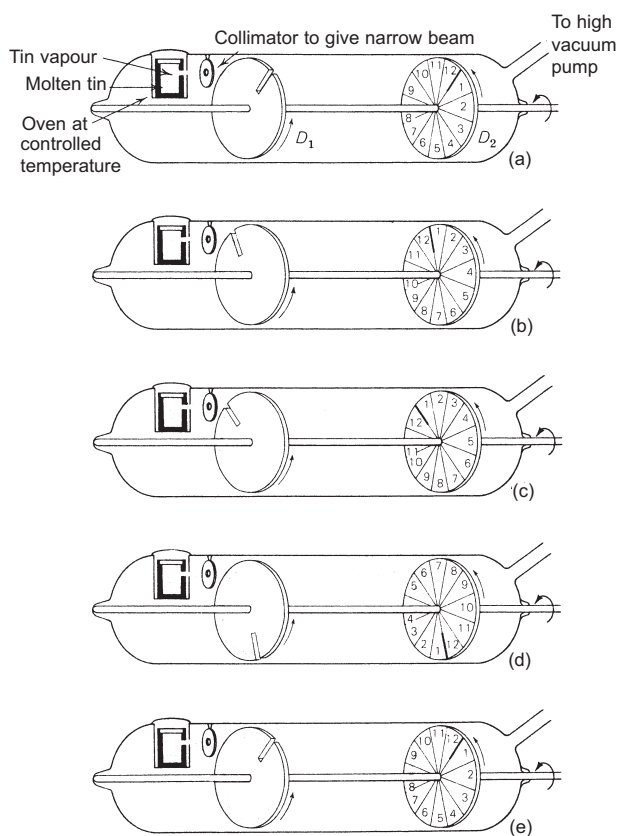

**The relative distribution of atomic or molecular velocities obtained from the rotating disk.**

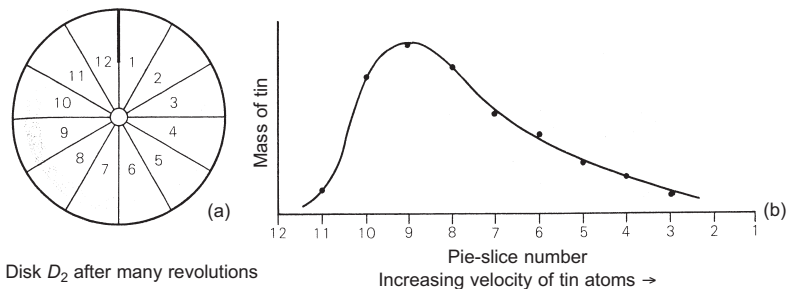

**Figures:** From *Chemistry: Experimental Foundations* by Robert W. Parry, Phyllis M. Dietz, Robert L. Tellefsen, & Luke E. Steiner © 1975 by Prentice Hall. Used by permission of Pearson Education, Inc.

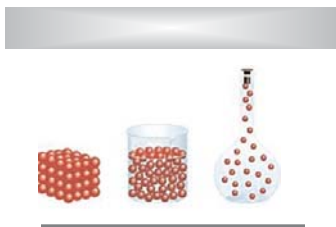
**SPECIFIC LEARNING OUTCOME**

**C11-1-02:** Use the Kinetic Molecular Theory to explain properties of gases.

Include: random motion, intermolecular forces, elastic collisions, average kinetic energy, temperature

(continued)

**TEACHER NOTES**

Once students understand the relationship of the average kinetic energy and temperature, show them what occurs in a sample of gas when the temperature is increased. Ask them to predict what the curve might look like in the rotating disk system if the temperature was increased.

The following diagram illustrates how the number of particles having a speed of  $u_1$  increases as the temperature is increased. Remind students that since  $KE = 1/2 mv^2$ , the diagrams also represent the relative change in average kinetic energies for a sample of gas in which the temperature has been increased. Ask students how they might measure the relative increase in the shaded area between the two diagrams.

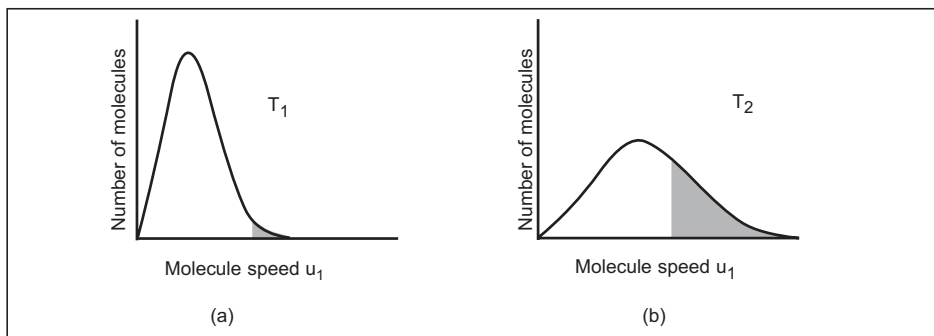

A piece of demonstration equipment called a Stoekle Tube could be used to show how increasing the temperature increases the speed of particles. The tube could also be used for learning outcome C11-1-03 to illustrate how the rate of evaporation is increased by an increase in temperature.

**SUGGESTIONS FOR ASSESSMENT**
**Rubrics/Checklists**

See Appendix 10 for a variety of rubrics and checklists that could be used for assessment.

**Pencil-and-Paper Tasks**

1. Students should be able to provide examples of situations where macroscopic events resemble elastic collisions (e.g., billiards, pool, hockey, super balls, air table, computer games).

### SKILLS AND ATTITUDES OUTCOMES

**C11-0-U1:** Use appropriate strategies and skills to develop an understanding of chemical concepts.

*Examples: analogies, concept frames, concept maps, manipulatives, particulate representations, role-plays, simulations, sort-and-predict frames, word cycles...*

**C11-0-U2:** Demonstrate an understanding of chemical concepts.

*Examples: use accurate scientific vocabulary, explain concepts to others, compare and contrast concepts, apply knowledge to new situations and/or contexts, create analogies, use manipulatives...*

---

2. Students should be able to explain the observable properties of gases using the Kinetic Molecular Model. To encourage students to gain confidence in their own explanations of concepts before explaining them to the class, have them use the following strategies:

- Concept Overview (see template in *Success for All Learners* 6.112)
- Listen-Draw-Pair-Share (*Success for All Learners* 6.97)

### Visual Displays

Student groups could review the postulates of the Kinetic Molecular Theory and display their knowledge in graphic representations such as

- diagrams
- posters
- charts
- bulletin boards

### Journal Writing

Have students provide other examples that would illustrate *perfectly elastic collisions*.

### LEARNING RESOURCES LINKS

---



*Chemistry* (Chang 191)

*Chemistry* (Zumdahl and Zumdahl 212)

*Chemistry: The Central Science* (Brown, et al. 386)

*Chemistry: Concepts and Applications* (Phillips, Strozak, and Wistrom 342)

*Chemistry: The Molecular Nature of Matter and Change* (Silberberg 197)

*Glencoe Chemistry: Matter and Change* (Dingrando, et al. 385)

*Introductory Chemistry: A Foundation* (Zumdahl 383)

*McGraw-Hill Ryerson Chemistry 11, Ontario Edition* (Mustoe, et al. 421)

*Prentice Hall Chemistry: Connections to Our Changing World* (LeMay, et al. 16)

*Success for All Learners* (Manitoba Education and Training 6.97, 6.112)

**SPECIFIC LEARNING OUTCOME**

**C11-1-03:** Explain the properties of liquids and solids using the Kinetic Molecular Theory.

(1.0 hour)

SLO: C11-1-03

**SUGGESTIONS FOR INSTRUCTION****Entry-Level Knowledge**

In Grade 7 Science, students were introduced to the particle theory of matter to explain changes of state. Discussion included the absorption or release of energy as a given phase change occurred. Students were also introduced to heating and cooling curves. There was, however, no discussion of intermolecular forces.

**Assessing Prior Knowledge**

Prior knowledge can be reviewed and/or assessed by using any of the KWL forms (e.g., Concept Map, Knowledge Chart, Think-Pair-Share—see *SYSTH*, Chapter 9).

**TEACHER NOTES**

Most chemistry textbooks relate the properties of solids and liquids to the Kinetic Molecular Theory.

Ask students to relate the properties of liquids and solids to the distances between particles, intermolecular forces of attraction, and the average kinetic energy of the particles. Students should understand that as the temperature increases, random motion increases, causing particles to move further apart and, therefore, reducing the strength of intermolecular forces. The overall reduction in forces holding particles in a particular phase allows phases to change as energy is absorbed. As each element and compound has a unique structure, it is reasonable to deduce that each has unique melting and boiling points.

Wherever possible, students should determine differences in the properties and structure of liquids and solids for themselves. Most textbooks will provide some physical data. The *CRC Handbook of Chemistry and Physics* is another resource.

**General Learning Outcome Connections**

- GLO B3:** Identify the factors that affect health, and explain the relationships among personal habits, lifestyle choices, and human health, both individual and social.
- GLO B5:** Identify and demonstrate actions that promote a sustainable environment, society, and economy, both locally and globally.
- GLO C1:** Recognize safety symbols and practices related to scientific and technological activities and to their daily lives, and apply this knowledge in appropriate situations.
- GLO C2:** Demonstrate appropriate scientific inquiry skills when seeking answers to questions.
- GLO C3:** Demonstrate appropriate problem-solving skills when seeking solutions to technological challenges.
- GLO D3:** Understand the properties and structures of matter, as well as various common manifestations and applications of the actions and interactions of matter.

**SKILLS AND ATTITUDES OUTCOMES**

**C11-0-S1:** Demonstrate work habits that ensure personal safety and the safety of others, as well as consideration for the environment.

Include: knowledge and use of relevant safety precautions, Workplace Hazardous Materials Information System (WHMIS), emergency equipment

**C11-0-S2:** State a testable hypothesis or prediction based on background data or on observed events.

**C11-0-S9:** Draw a conclusion based on the analysis and interpretation of data.

Include: cause-and-effect relationships, alternative explanations, supporting or rejecting a hypothesis or prediction

Encourage students to make lists of the viscosity and density of common substances. A review of the data collected will enable students to relate the unique physical properties to their particulate structure.

Solids can be categorized into two main categories: *crystalline* and *amorphous*. There are four types of crystalline solids:

- covalent network (e.g., diamond, graphite)
- ionic (e.g., NaCl, CaF<sub>2</sub>)
- molecular (e.g., I<sub>2</sub>, S<sub>8</sub>)
- metallic (e.g., Cu, Ag)

Amorphous solids are those that lack a regular three-dimensional arrangement of atoms (e.g., glass, lampblack).

The crystal structures that should be emphasized are those for ionic and molecular solids. Most chemistry texts provide a good description of unit cell structures, lattice structures, and various types of crystal structures. Students should only be exposed to the simplest of crystal structures.

**Ionic Compounds**

Using a microscope, students can examine the macroscopic characteristics of a crystal of salt. They should be able to see the macroscopic regular cubic structure and then extend their findings to the molecular level. Students should understand the concept with relationship to the diagram below.

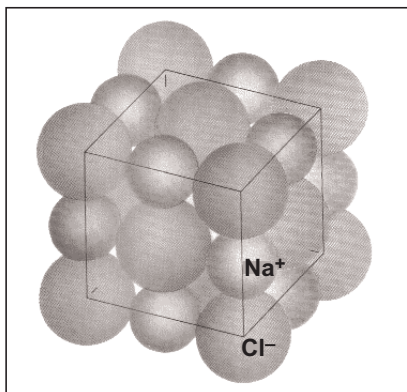

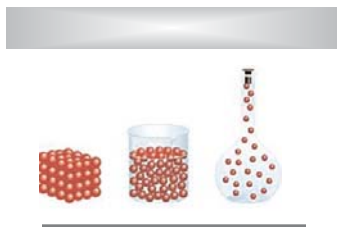

**SPECIFIC LEARNING OUTCOME**

**C11-1-03:** Explain the properties of liquids and solids using the Kinetic Molecular Theory.

(continued)

A sodium and a chloride ion:

**Sodium +1**

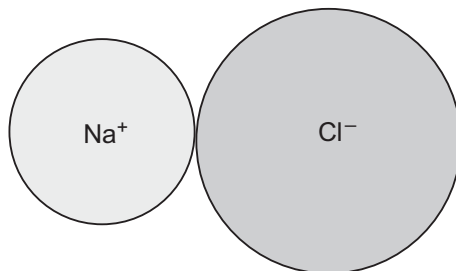

**Chloride -1**

or Na — Cl

**Oppositely charged ions are held together by an electrostatic force of attraction.**

A two-dimensional array of two sodium ions and two chloride ions:

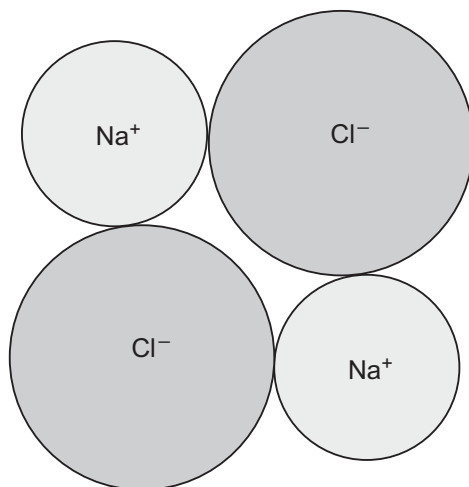

or Na — Cl  
 |        |  
 Cl — Na

**SKILLS AND ATTITUDES OUTCOMES**

**C11-0-S1:** Demonstrate work habits that ensure personal safety and the safety of others, as well as consideration for the environment.

Include: knowledge and use of relevant safety precautions, Workplace Hazardous Materials Information System (WHMIS), emergency equipment

**C11-0-S2:** State a testable hypothesis or prediction based on background data or on observed events.

**C11-0-S9:** Draw a conclusion based on the analysis and interpretation of data.

Include: cause-and-effect relationships, alternative explanations, supporting or rejecting a hypothesis or prediction

A three-dimensional cubic lattice containing sodium and chloride ions:

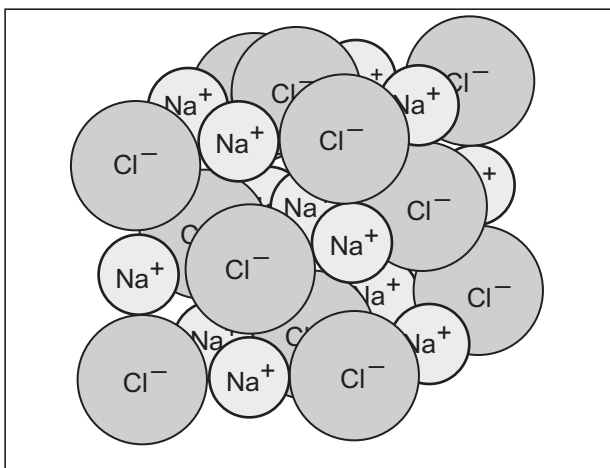

**Covalent Compounds**

Rather than looking at a sugar crystal macroscopically, students can view an electron micrograph picture (or similar representation) of a crystal of sugar. In these compounds, crystals are still formed but the molecules within the crystals are held together by covalent bonds.

**TEACHER NOTES**

*A molecular model of sugar is shown below:*

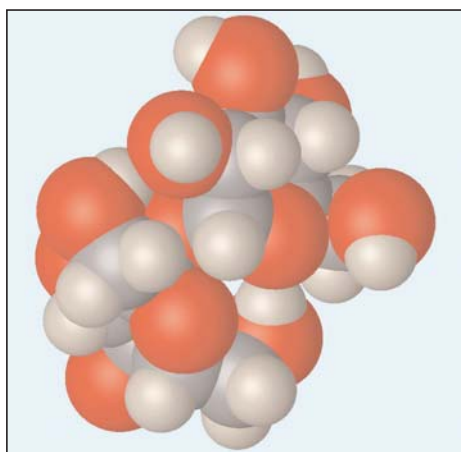



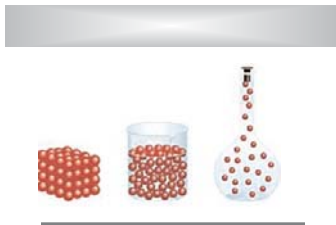

**SPECIFIC LEARNING OUTCOME**

**C11-1-03:** Explain the properties of liquids and solids using the Kinetic Molecular Theory.

(continued)

The *crystal structure of diamond*, one of the allotropic forms of carbon, can be seen below:

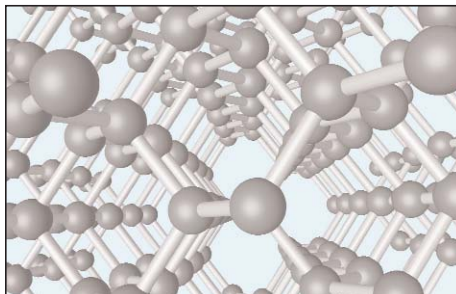

The following articles provide additional information about diamonds and their properties:

- Brubacher, Lew. "Diamonds." *CHEM 13 NEWS* 327 (Feb. 2005): 1, 4-6.
- Clinton, Laura, and Catheryn Lee. "Diamonds in the Snow." *CHEM 13 NEWS* 327 (Feb. 2005): 6-7.

Another allotropic form of carbon is *graphite*, represented in the diagram below:

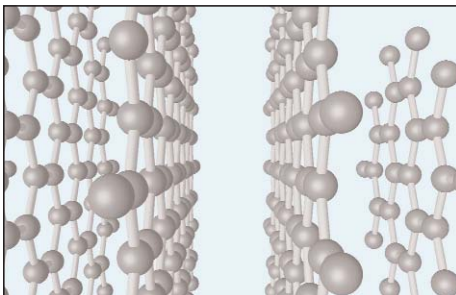

Glass is often defined as an optically transparent fusion product of inorganic material that has been cooled to a solid state without crystallization.

Melting sand normally requires very high temperatures. However, if sodium is added to ordinary sand it acts as a flux to lower the melting point of the silica sand (silicon dioxide,  $\text{SiO}_2$ ) so it can melt and more easily form a "glass." By adding sodium to the mix, the viscosity of a glass can be tuned to specific requirements. The stoichiometry of glass is not fixed and so the addition of various components causes a proportional change in the properties of the glass. The addition of sodium carbonate results in common glass. By adding inorganic elements to the mix, various colours are produced (e.g., gold causes a ruby red colour in the glass,

**SKILLS AND ATTITUDES OUTCOMES**

**C11-0-S1:** Demonstrate work habits that ensure personal safety and the safety of others, as well as consideration for the environment.

Include: knowledge and use of relevant safety precautions, Workplace Hazardous Materials Information System (WHMIS), emergency equipment

**C11-0-S2:** State a testable hypothesis or prediction based on background data or on observed events.

**C11-0-S9:** Draw a conclusion based on the analysis and interpretation of data.

Include: cause-and-effect relationships, alternative explanations, supporting or rejecting a hypothesis or prediction

---

whereas the addition of antimony causes a canary yellow colour. Glass is macroscopically a solid, with melting temperatures from 1000°C to 1500°C. A crystal structure is completely absent due to rapid cooling.

About 800 types of glass are used today. The addition of B<sub>2</sub>O<sub>3</sub> to the mix forms a glass that has a low coefficient of expansion commonly known as borosilicate glass or Pyrex<sup>®</sup>. Glass that contains potassium oxide is so hard that it is used to manufacture glass lenses.

One of the most important uses of glass occurs in the manufacture of optical cable. Because impurities cause so much variation in the properties of glass, the glass used in the formation of optical fibres must be ultra-pure, usually less than 1 ppb. The uniqueness of an optical fibre is that it has total internal reflectance or 100% transmission of the input signal. Optical data travelling along an optical fibre need only be regenerated every 100 km, whereas a similar signal travelling through copper cable must be regenerated every 4 to 6 km. Another interesting comparison is that a copper wire would require 25,000 times as much mass as an optical fibre to send the same data.

It has been suggested that a new use for impervious glass products might be the storage of radioactive byproducts. Currently, thousands of tonnes of highly radioactive materials are stored in a variety of containers all over North America. These containers have been found to be less resistant to age than was once thought. There is now evidence that some of these “safe” containers are leaking. An idea that has recently surfaced is to embed radioactive materials in glass to make them completely impervious to solvents and decay. It has been found that glass can hold up to 30% of its mass as waste materials.

**Laboratory Activity**

The lab activity Bond Types and Conductivity (see Appendix 1.5) asks students to identify the type of bonding based on electrical conductivity and probeware.

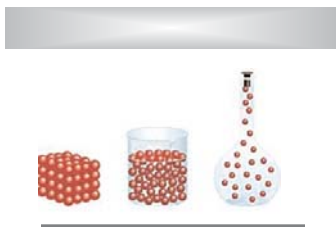

### SPECIFIC LEARNING OUTCOME

**C11-1-03:** Explain the properties of liquids and solids using the Kinetic Molecular Theory.

(continued)

### Activities

Have students:

1. Display various physical data as a spreadsheet and graph, according to the technical expertise and experience of students, and the equipment available to them.
2. Sketch simple crystal shapes.
3. Make a representation of crystals using mini-marshmallows and toothpicks.
4. Draw a concept map of the various types of solids, including examples.
5. Research different types of glasses and their uses. (To assist students with their research, provide them with a copy of Appendix 1.6: Chemistry Article Review Form.)



### SUGGESTIONS FOR ASSESSMENT

---

#### Rubrics/Checklists

See Appendix 10 for a variety of rubrics and checklists that can be used for self-assessment, peer assessment, and teacher assessment.

#### Research Reports

Have students, individually or in small groups, research and report on any of the topics related to learning outcome C11-1-03. The information collected could then be presented as

- written reports
- oral presentations
- bulletin board displays
- multimedia presentations

#### Visual Displays

Students could present their collected material using

- posters
- pamphlets
- bulletin boards
- models

### SKILLS AND ATTITUDES OUTCOMES

**C11-0-S1:** Demonstrate work habits that ensure personal safety and the safety of others, as well as consideration for the environment.

Include: knowledge and use of relevant safety precautions, Workplace Hazardous Materials Information System (WHMIS), emergency equipment

**C11-0-S2:** State a testable hypothesis or prediction based on background data or on observed events.

**C11-0-S9:** Draw a conclusion based on the analysis and interpretation of data.

Include: cause-and-effect relationships, alternative explanations, supporting or rejecting a hypothesis or prediction

---

### Journal Writing

1. Have students write opinions or reflections regarding the storage of radioactive waste by-products in less than safe containers.
2. Have students reflect on the impact that optical fibres have had on electronics and technology.

### LEARNING RESOURCES LINKS

---



*Chemistry* (Chang 443)

*Chemistry* (Zumdahl and Zumdahl 449)

*Chemistry: The Central Science* (Brown, et al. 407)

*Chemistry: Concepts and Applications* (Phillips, Strozak, and Wistrom 344)

*Chemistry: The Molecular Nature of Matter and Change* (Silberberg 419)

*CRC Handbook of Chemistry and Physics* (Weast)

*Glencoe Chemistry: Matter and Change* (Dingrando, et al. 396)

*Introductory Chemistry: A Foundation* (Zumdahl 399)

*Nelson Chemistry 12, Ontario Edition* (van Kessel, et al. 262, 268)

*Nelson Chemistry 12: College Preparation, Ontario Edition* (Davies, et al. 330)

*Prentice Hall Chemistry: Connections to Our Changing World* (LeMay, et al. 467)

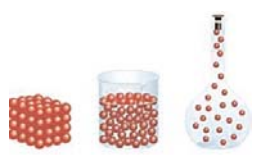

**SPECIFIC LEARNING OUTCOME**

**C11-1-04:** Explain the process of melting, solidification, sublimation, and deposition in terms of the Kinetic Molecular Theory.  
Include: freezing point, exothermic, endothermic

(2.0 hours)

SLO: C11-1-04

**SUGGESTIONS FOR INSTRUCTION**

**Entry-Level Knowledge**

In Grade 7 Science, students were introduced to the particle theory of matter to explain changes of state. Discussion included the absorption or release of energy as a given phase change occurred. Students were also introduced to heating and cooling curves.

Students should have a good understanding of the three major states of matter and phase changes, both from previous science courses and from general experience.

A typical phase diagram illustrating students' prior knowledge might look as follows:

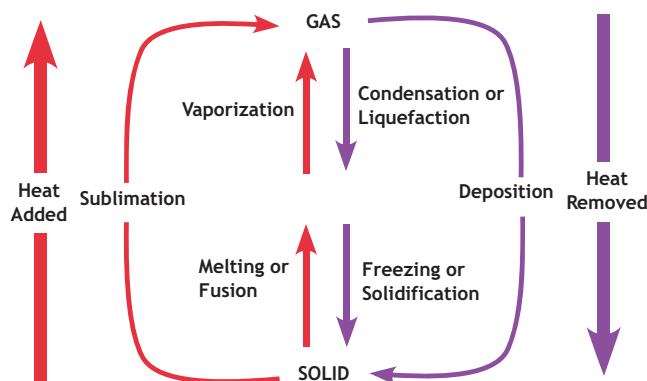

**General Learning Outcome Connections**

- GLO B3:** Identify the factors that affect health, and explain the relationships among personal habits, lifestyle choices, and human health, both individual and social.
- GLO B5:** Identify and demonstrate actions that promote a sustainable environment, society, and economy, both locally and globally.
- GLO C1:** Recognize safety symbols and practices related to scientific and technological activities and to their daily lives, and apply this knowledge in appropriate situations.
- GLO C2:** Demonstrate appropriate scientific inquiry skills when seeking answers to questions.
- GLO C3:** Demonstrate appropriate problem-solving skills when seeking solutions to technological challenges.
- GLO D3:** Understand the properties and structures of matter, as well as various common manifestations and applications of the actions and interactions of matter.
- GLO D4:** Understand how stability, motion, forces, and energy transfers and transformations play a role in a wide range of natural and constructed contexts.
- GLO E4:** Recognize that energy, whether transmitted or transformed, is the driving force of both movement and change, and is inherent within materials and in the interactions among them.

**SKILLS AND ATTITUDES OUTCOMES**

**C11-0-S1:** Demonstrate work habits that ensure personal safety and the safety of others, as well as consideration for the environment.

Include: knowledge and use of relevant safety precautions, Workplace Hazardous Materials Information System (WHMIS), emergency equipment

**C11-0-S2:** State a testable hypothesis or prediction based on background data or on observed events.

**C11-0-S9:** Draw a conclusion based on the analysis and interpretation of data.

Include: cause-and-effect relationships, alternative explanations, supporting or rejecting a hypothesis or prediction

---

**Assessment of Prior Knowledge**

Either question students regarding their prior knowledge or have them complete one of the following:

- Concept Overview sheet (*Success for All Learners* 6.112)
- Knowledge Chart (*Success for All Learners* 6.95)

**TEACHER NOTES**

Introduce the terms *endothermic* and *exothermic processes*. Then ask students whether they can add energy arrows to the diagram they have produced, indicating heat added or heat removed. Students may also be able to sketch heating curves and cooling curves for water.

Before students can fully understand the particle mechanics of phase change, they need to understand the forces that are involved. Students should be able to relate the energy required to cause a solid to change into a liquid to the intermolecular forces of attraction holding the particles together. These forces account for variations in melting point, boiling point, and other characteristic properties of solids, liquids, and gases. During phase changes, the addition of heat energy causes an increase in kinetic energy, which is used to break the forces of attraction between particles so that they can change from one state to the next. Particles that are left behind continue to absorb additional energy from the added heat until they are able to change state.

Most chemistry texts provide a good explanation of phase changes. Emphasize to students that a minimum amount of kinetic energy is required for particles to change to the next phase in order to overcome the intermolecular forces of attraction holding the particles together. This is often called the *threshold energy*. This energy is released for the reverse exothermic phase change. Recall the kinetic energy distribution curve diagrams discussed in the Teacher Notes for learning outcome C11-1-02. Even though the diagrams were derived experimentally for gases, scientists believe they apply to all phases of matter.

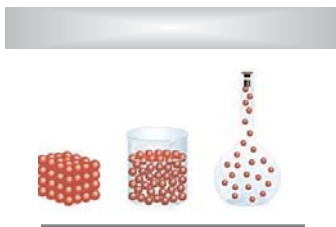

### SPECIFIC LEARNING OUTCOME

**C11-1-04:** Explain the process of melting, solidification, sublimation, and deposition in terms of the Kinetic Molecular Theory.

Include: freezing point, exothermic, endothermic

(continued)

### Demonstration Activities

It is not intended that all demonstration activities should be done. Select activities appropriate for the class. Most students can provide examples of sublimation (e.g., mothballs, solid air fresheners, dry ice).

1. If there is access to a correctly functioning fume hood, demonstrate the gentle warming of a few crystals of solid iodine in a large test tube.
2. The deposition of iodine vapour was used in the past in fingerprint detection. A procedure can be found in Appendix 1.7: Making Fingerprints Visible.
3. Dry ice is an excellent demonstration substance, although it sublimates rapidly even when kept in a freezer.
4. Other solids, such as benzoic acid, will also sublime.
5. If a spare CO<sub>2</sub> fire extinguisher is available and permission is obtained for its use in the school, the cylinder can be partially discharged into a cloth bag. Carefully examine the resulting solid and discuss observations with students.

### Discrepant Event

Place several mothballs or mothball flakes in a small beaker over a very low flame. Secure a round-bottomed flask containing ice water over the beaker. Slowly heat the mothballs until they have all disappeared. Lift the flask to display the crystals that have formed on the bottom of the flask. Have students write down their observations and a conclusion. **Caution:** This event should be performed in a fume hood.

### Laboratory Activities

Ask students to determine the melting point (MP) of a number of solids and then use this information to identify an unknown. For this experiment, see Appendix 1.8: Probeware Investigation: Determining Melting Points.

Any of the following solids could be used for this lab:

- stearic acid           MP 69.6°C
- palmitic acid       MP 63.0°C
- thymol               MP 50.0°C
- maleic anhydride   MP 53.0°C
- cinnamic acid       MP 42.0°C

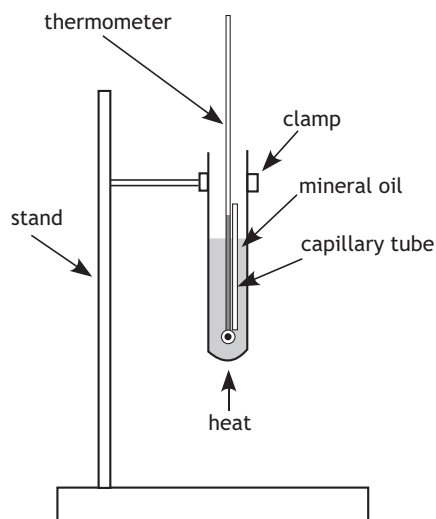

**SKILLS AND ATTITUDES OUTCOMES**

**C11-0-S1:** Demonstrate work habits that ensure personal safety and the safety of others, as well as consideration for the environment.

Include: knowledge and use of relevant safety precautions, Workplace Hazardous Materials Information System (WHMIS), emergency equipment

**C11-0-S2:** State a testable hypothesis or prediction based on background data or on observed events.

**C11-0-S9:** Draw a conclusion based on the analysis and interpretation of data.

Include: cause-and-effect relationships, alternative explanations, supporting or rejecting a hypothesis or prediction

---

**Research Activities**

Have students research the following:

1. Research freeze-drying, or cryogenics. The information could be presented as a poster, an article, a *PowerPoint* presentation, a class presentation, or a debate. Cryogenics will be discussed again when students are introduced to Charles's Law, Kelvin, and absolute zero.
2. Research the mean average temperatures of interior and coastal regions to determine the moderating effect of large bodies of water.
3. Research the operation of simple cooling devices (e.g., camp cooler – canvas bag that, when filled with water, keeps cool from the evaporation of water from the canvas) and other devices such as refrigerators and air conditioners

**SUGGESTIONS FOR ASSESSMENT**

---

**Laboratory Reports**

The demonstrations and events outlined for learning outcome C11-1-04 could be assessed as either formal lab reports using the Laboratory Report Format (see *SYSTH* 14.12) or by using questions and answers from the data collected from the various activities.

**Paper-and-Pencil Tasks**

Students should be able to use the Kinetic Molecular Theory to explain how melting, solidification, sublimation, and deposition occur.

**Research Reports**

Student research and reports could be presented as

- written reports
- oral presentations
- bulletin board displays
- multimedia presentations

The research assignments could be assessed using any of the rubrics designed specifically for research projects (see Appendix 10).



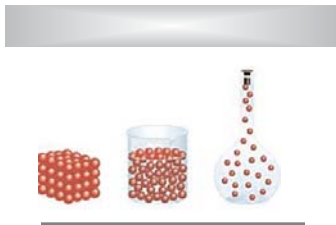

### SPECIFIC LEARNING OUTCOME

**C11-1-04:** Explain the process of melting, solidification, sublimation, and deposition in terms of the Kinetic Molecular Theory.  
Include: freezing point, exothermic, endothermic

(continued)

---

### LEARNING RESOURCES LINKS

---



*Chemistry* (Chang 462)

*Chemistry* (Zumdahl and Zumdahl 489)

*Chemistry: The Central Science* (Brown, et al. 407)

*Chemistry: Concepts and Applications* (Phillips, Strozak, and Wistrom 364)

*Chemistry: The Molecular Nature of Matter and Change* (Silberberg 419)

*Chemistry with Computers* (Holmquist and Volz, Freezing and Melting of Water) – Available from Vernier: <<http://www.vernier.com/chemistry/>>

*Glencoe Chemistry: Matter and Change* (Dingrando, et al. 404)

*Glencoe Chemistry: Matter and Change: CBL Laboratory Manual – Teacher Edition* (LAB 3: Melting and Freezing Points, 9)

*Introductory Chemistry: A Foundation* (Zumdahl 401)

*PASPort Explorations in Chemistry Lab Manual* (PASCO Scientific) – Available from PASCO: <<http://www.pasco.com/hsmanuals/ps2808.html>>

*Prentice Hall Chemistry: Connections to Our Changing World* (LeMay, et al. 485)

*Success for All Learners* (Manitoba Education and Training 6.95, 6.112)

**SKILLS AND ATTITUDES OUTCOMES**

**C11-0-S1:** Demonstrate work habits that ensure personal safety and the safety of others, as well as consideration for the environment.

Include: knowledge and use of relevant safety precautions, Workplace Hazardous Materials Information System (WHMIS), emergency equipment

**C11-0-S2:** State a testable hypothesis or prediction based on background data or on observed events.

**C11-0-S9:** Draw a conclusion based on the analysis and interpretation of data.

Include: cause-and-effect relationships, alternative explanations, supporting or rejecting a hypothesis or prediction

---

**NOTES**

**SPECIFIC LEARNING OUTCOMES**

**C11-1-05:** Use the Kinetic Molecular Theory to explain the processes of evaporation and condensation.

Include: intermolecular forces, random motion, volatility, dynamic equilibrium

**C11-1-06:** Operationally define vapour pressure in terms of observable and measurable properties.

(1.5 hours)

SLO: C11-1-05  
SLO: C11-1-06

**SUGGESTIONS FOR INSTRUCTION****Entry-Level Knowledge**

The Kinetic Molecular Theory is discussed in some detail in relation to learning outcome C11-1-04. Students should be familiar with the components of the particle theory and the Kinetic Molecular Theory, and all the related concepts such as average kinetic energy and elastic collisions.

**Assessing Prior Knowledge**

Check for student understanding of prior knowledge and review as necessary. Prior knowledge can be reviewed and/or assessed by using any of the KWL strategies (e.g., Concept Map, Knowledge Chart, Think-Pair-Share—see *SYSTH*, Chapter 9).

**TEACHER NOTES**

Most students are well aware of the process of vaporization, evaporation, and the absorption of energy. Reintroduce these concepts through observation. The following activities will focus students' knowledge and allow them to confirm operational definitions. It is not intended that all activities and discrepant events be done. Select those appropriate for the class.

**Activities**

A number of activities can be done to measure qualitatively the differences in the intermolecular forces in liquids by measuring the relative rates of evaporation. The following liquids are suggested for the first two activities: water, ethanol, methanol, acetone, isopropyl alcohol, and cyclohexane.

1. Swab each liquid onto an impermeable smooth surface and observe the time it takes for the liquid to disappear. **Do not** place on skin.
2. Place a fixed volume of each liquid on a watch glass and record the mass loss as a function of time on a centigram balance.

**General Learning Outcome Connections**

**GLO C3:** Demonstrate appropriate problem-solving skills when seeking solutions to technological challenges.

**GLO D3:** Understand the properties and structures of matter, as well as various common manifestations and applications of the actions and interactions of matter.

**GLO E4:** Recognize that energy, whether transmitted or transformed, is the driving force of both movement and change, and is inherent within materials and in the interactions among them.

**SKILLS AND ATTITUDES OUTCOMES**

**C11-0-S1:** Demonstrate work habits that ensure personal safety and the safety of others, as well as consideration for the environment.

Include: knowledge and use of relevant safety precautions, Workplace Hazardous Materials Information System (WHMIS), emergency equipment

**C11-0-S2:** State a testable hypothesis or prediction based on background data or on observed events.

**C11-0-S9:** Draw a conclusion based on the analysis and interpretation of data.

Include: cause-and-effect relationships, alternative explanations, supporting or rejecting a hypothesis or prediction

---

3. The Vapour Pressure with Pop activity (see Appendix 1.9) involves a volatile liquid and a sealed container. It is possible for students to design variations on this activity. Essentially, a small amount of pentane or other very volatile liquid such as acetone is placed into a tennis-ball can with a plastic lid that closes tightly. When students roll the tube in their hands, they will immediately feel the drop in temperature as the liquid cools. When enough pressure has been created, the cap will fly off with a loud noise. This activity could be modified to be quantitative. The Material Safety Data Sheet for each substance should contain the vapour pressure of the liquid. By calculating the surface area of the tube, the total pressure can be determined. For a typical tennis-ball can and petroleum ether, the pressure is about 60 psi. (See Appendix 1.9 for more details.)

**Discrepant Events**

1. Place one thermometer in the breeze of a fan and place an identical thermometer near the fan but not in the breeze. Ask students to predict which thermometer will show the lowest temperature. Discuss the results. Place some wet cotton gauze around the bulbs of both thermometers and repeat. Discuss the results. Calculator-based laboratories (CBLs) or microcomputer-based laboratories (MBLs) could be used to collect the data. References are provided in the Learning Resources Links.
2. While holding a burning match, quickly blow out a candle that has been burning with a strong flame and place the match in the smoke trail. Have students observe and discuss the results.

**TEACHER NOTES**

In learning outcome C11-1-04, students were introduced to the concept that a minimum amount of energy is required to overcome the intermolecular forces of attraction that hold particles in a crystal structure. If this energy were exceeded, particles would tend to break off from the existing crystal structure and change to the more energetic liquid phase. As the temperature increases, the average kinetic energy (KE) of the solid substance increases and more particles would have enough energy to “escape” and become particles of the liquid phase. The same rationale can be made for liquid particles changing to the gaseous phase.

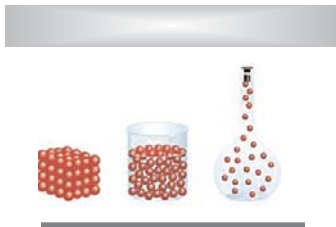

**SPECIFIC LEARNING OUTCOMES**

**C11-1-05:** Use the Kinetic Molecular Theory to explain the processes of evaporation and condensation.

Include: intermolecular forces, random motion, volatility, dynamic equilibrium

**C11-1-06:** Operationally define vapour pressure in terms of observable and measurable properties.

(continued)

*Vaporization* is the process by which a liquid changes to a gas or a vapour. When vaporization occurs only at the surface of a liquid, the process is called *evaporation*. If a sample of liquid is left open to the air, particles at the surface ● may collide with other particles and absorb enough kinetic energy to overcome the forces of attraction and change into the gaseous state. However, if a particle collides with an air particle above it, it may lose energy and become part of the liquid again (see diagram below).

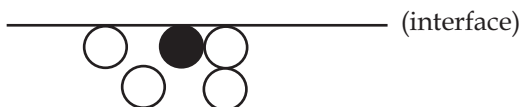

More particles and, therefore, generally greater forces of attraction surround a particle within the liquid, as shown in the following diagram.

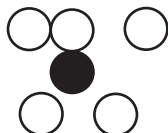

If a particle within the liquid absorbs enough energy to change into a gaseous particle, it is more likely to collide with another liquid particle, lose energy, and return to the liquid state. This argument can be used to explain why evaporation is a surface phenomenon.

Simple experiments show that if the surface area is increased, the rate of evaporation increases. At the surface, two processes are occurring: a rate of evaporation and a rate of condensation as gaseous particles are “recaptured” by the liquid state. If a container of liquid is open, the rate of evaporation will usually exceed the rate of condensation and the level of the liquid will drop as liquid particles move into the gaseous state (see diagram below).

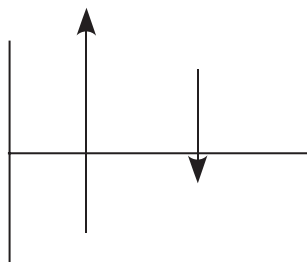

**SKILLS AND ATTITUDES OUTCOMES**

**C11-0-S1:** Demonstrate work habits that ensure personal safety and the safety of others, as well as consideration for the environment.

Include: knowledge and use of relevant safety precautions, Workplace Hazardous Materials Information System (WHMIS), emergency equipment

**C11-0-S2:** State a testable hypothesis or prediction based on background data or on observed events.

**C11-0-S9:** Draw a conclusion based on the analysis and interpretation of data.

Include: cause-and-effect relationships, alternative explanations, supporting or rejecting a hypothesis or prediction

However, if the container is closed, the rate of condensation will eventually equal the rate of evaporation and the level of the liquid will no longer change, if the temperature is kept constant. This is called a *dynamic equilibrium*.

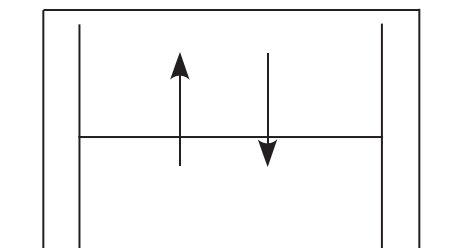
**Class Discussion**

Students could discuss responses to the following questions:

- What would happen if the temperature were changed?
- What would cause the level of liquid in an open container to stop dropping?
- Why do liquids evaporate at different rates?
- What would happen to either the open or closed system if a solid were dissolved in the liquid? (Extension activity)
- Predict what will happen if there are two containers with a solvent sealed inside them. One container contains a solute.

**TEACHER NOTES**

Remind students that when scientists talk about evaporation, vapours are inevitably mentioned. A *vapour* is the gaseous state of a substance that is normally liquid or solid at room temperature. Substances that evaporate rapidly are said to be volatile. They have lower intermolecular forces of attraction that hold particles into the liquid phase. Gasoline, paint thinner, alcohol, and dry-cleaning solvents are all volatile.

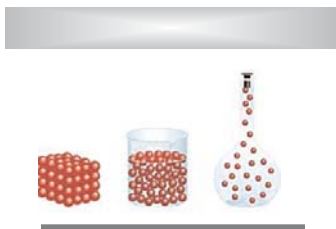
**SPECIFIC LEARNING OUTCOMES**

**C11-1-05:** Use the Kinetic Molecular Theory to explain the processes of evaporation and condensation.

Include: intermolecular forces, random motion, volatility, dynamic equilibrium

**C11-1-06:** Operationally define vapour pressure in terms of observable and measurable properties.

(continued)

**Laboratory Activity**

Have students measure the vapour pressure of a number of liquids (e.g., water, ethanol, methanol, 2-propanol, cyclohexane) at  $\approx 20^{\circ}\text{C}$  and  $0^{\circ}\text{C}$ . Ask students to share results and draw conclusions as a class. The experiment should show that vapour pressure is independent of the amount of liquid in the container. (See Appendix 1.10: Measuring the Vapour Pressure of a Liquid.)

**Calculator-Based Laboratory (CBL) Activities**

1. Vernier has an interesting experiment in which students measure the amount of energy required to evaporate a volatile liquid. By sampling a number of liquids, a relationship is established between the energy absorbed during evaporation and the intermolecular forces within the liquid. See *Chemistry with Calculators* (Holmquist and Volz—Vernier Software, Expt. 9.1).
2. Another lab (see Appendix 1.11: Forces between Particles) uses a pressure sensor and a temperature probe to measure the relative forces of attraction in a selection of volatile liquids.

**Research Activity**

Have student groups research the following topics:

- how the refrigerator, air conditioner, or dehumidifier works
- camp coolers
- vapour pressure of mercury and toxicity
- water vapour in the air

**SUGGESTIONS FOR ASSESSMENT****Rubrics/Checklists**

See Appendix 10 for a variety of rubrics and checklists that can be used for self-assessment, peer assessment, and teacher assessment.

**SKILLS AND ATTITUDES OUTCOMES**

**C11-0-S1:** Demonstrate work habits that ensure personal safety and the safety of others, as well as consideration for the environment.

Include: knowledge and use of relevant safety precautions, Workplace Hazardous Materials Information System (WHMIS), emergency equipment

**C11-0-S2:** State a testable hypothesis or prediction based on background data or on observed events.

**C11-0-S9:** Draw a conclusion based on the analysis and interpretation of data.

Include: cause-and-effect relationships, alternative explanations, supporting or rejecting a hypothesis or prediction

---

**Research Reports**

Student research could be reported or presented either individually or in small groups. The information collected could be presented as

- written reports
- oral presentations
- bulletin board displays
- multimedia presentations

**Visual Displays**

Students could present the material they have collected using

- posters
- pamphlets
- bulletin boards
- models

Each of these presentation styles could be assessed using an appropriate rubric created with students prior to the assignment. Samples of presentation rubrics are provided in Appendix 10.

**Laboratory Reports**

The vapour pressure lab activity could be assessed either as formal lab reports using the Laboratory Report Format (see *SYSTH 14.12*) or by using questions and answers from the data collected from the lab activity.

**Paper-and-Pencil Tasks**

Students should be able to answer questions that relate to the Kinetic Molecular Theory and phase changes. Several questions are included in the Suggestions for Instruction.

**Journal Writing**

The unusual discrepant events suggested for this learning outcome could be included as journal entries.



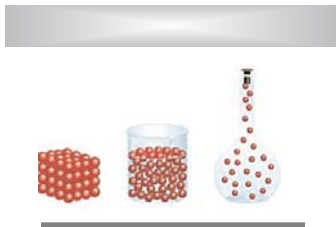

### SPECIFIC LEARNING OUTCOMES

**C11-1-05:** Use the Kinetic Molecular Theory to explain the processes of evaporation and condensation.

Include: intermolecular forces, random motion, volatility, dynamic equilibrium

**C11-1-06:** Operationally define vapour pressure in terms of observable and measurable properties.

(continued)

---

### LEARNING RESOURCES LINKS

---



*Chemistry* (Chang 463)

*Chemistry* (Zumdahl and Zumdahl 483)

*Chemistry: The Central Science* (Brown, et al. 425)

*Chemistry: Concepts and Applications* (Phillips, Strozak, and Wistrom 356)

*Chemistry: The Molecular Nature of Matter and Change* (Silberberg 428)

*Chemistry with Calculators* (Holmquist and Volz) – Available from Vernier:  
<<http://www.vernier.com/chemistry/>>

*Chemistry with Computers* (Holmquist and Volz) – Available from Vernier:  
<<http://www.vernier.com/chemistry/>>

*Glencoe Chemistry: Matter and Change* (Dingrando, et al. 406)

*Glencoe Chemistry: Matter and Change: CBL Laboratory Manual – Teacher Edition*  
(LAB 3: Melting and Freezing Points, 9)

*Glencoe Chemistry: Matter and Change: Laboratory Manual – Teacher Edition*

*Introductory Chemistry: A Foundation* (Zumdahl 408)

*PASPort Explorations in Chemistry Lab Manual* (PASCO Scientific) – Available  
from PASCO: <<http://www.pasco.com/hsmanuals/ps2808.html>>

*Prentice Hall Chemistry: Connections to Our Changing World* (LeMay, et al. 428,  
520)

**SKILLS AND ATTITUDES OUTCOMES**

**C11-0-S1:** Demonstrate work habits that ensure personal safety and the safety of others, as well as consideration for the environment.

Include: knowledge and use of relevant safety precautions, Workplace Hazardous Materials Information System (WHMIS), emergency equipment

**C11-0-S2:** State a testable hypothesis or prediction based on background data or on observed events.

**C11-0-S9:** Draw a conclusion based on the analysis and interpretation of data.

Include: cause-and-effect relationships, alternative explanations, supporting or rejecting a hypothesis or prediction

---

**NOTES**

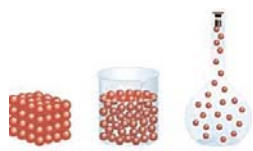

## SPECIFIC LEARNING OUTCOME

**C11-1-07:** Operationally define normal boiling point temperature in terms of vapour pressure.

(0.5 hour)

SLO: C11-1-07

## SUGGESTIONS FOR INSTRUCTION

## Entry-Level Knowledge

In Grade 7 Science, students were introduced to the concept that the boiling point of a pure substance is a characteristic property. No explanation was discussed. The learning outcomes in Topic 1 of Grade 11 Chemistry serve as an introduction to the *normal boiling point*.

## Discrepant Events

It is not intended that all discrepant events be demonstrated. Select those appropriate for the class. Events 3 and 4 are not related to learning outcome C11-1-07 but are entertaining! These events could be used to address Boyle's Law (learning outcome C11-2-05).

1. This demonstration could be used to introduce boiling. After heating water (with boiling beads or chips) in a flat-bottomed flask to boiling, place a one-hole stopper with a thermometer in the flask and invert. Place a cold wet cloth on or pour cold water over the bottom of the flask. Have students observe and discuss the results. If a vacuum pump is available, the demonstration can be done at much lower temperatures. Remember to insert a  $\text{CaCl}_2$  drying tube into the system before turning on the vacuum pump. **Caution:** Do not have students insert thermometers into stoppers.
2. Boil water in a kettle and have students observe the path of the steam. Place a lit candle just under the path of the steam. Have students observe and discuss the results.
3. If a vacuum pump and a bell jar are available, place marshmallows into the chamber and turn on the pump. Have students observe and explain what occurs.
4. If a large plastic syringe is available, the demonstration with marshmallows can still be done if the needle end is plugged.

## General Learning Outcome Connections

- GLO C6:** Employ effective communication skills and use information technology to gather and share scientific and technological ideas and data.
- GLO C8:** Evaluate, from a scientific perspective, information and ideas encountered during investigations and in daily life.
- GLO D3:** Understand the properties and structures of matter, as well as various common manifestations and applications of the actions and interactions of matter.
- GLO E4:** Recognize that energy, whether transmitted or transformed, is the driving force of both movement and change, and is inherent within materials and in the interactions among them.

**SKILLS AND ATTITUDES OUTCOME****C11-0-U2:** Demonstrate an understanding of chemical concepts.

*Examples: use accurate scientific vocabulary, explain concepts to others, compare and contrast concepts, apply knowledge to new situations and/or contexts, create analogies, use manipulatives...*

---

5. A similar demonstration can be done by placing a warm volatile liquid into the syringe and rapidly reducing the pressure. The liquid will begin to boil until the pressure is returned to normal. Have students operationally define boiling in terms of their observations of the preceding events.
6. Demonstrate “freezing by boiling.” If cyclohexane is used in a syringe, the liquid will boil and then freeze. For complete instructions, see Appendix 1.12: Freezing by Boiling.

**Laboratory Activity**

If probeware and computer access is available, students can measure the effect of increased pressure on the boiling point of a liquid. For a full description of this lab activity, see Appendix: 1.13: Gas Laws: Temperature and Pressure Changes.

**TEACHER NOTES**

At low temperatures and low average kinetic energy, only the particles at the surface are able to evaporate into the gaseous state. As the temperature of the liquid increases, however, the number of particles having enough energy to overcome the intermolecular forces of attraction increases so that particles within the liquid are also able to change to gaseous particles. These gaseous particles form micro-bubbles within the liquid. If the vapour pressure of these micro-bubbles is less than the atmospheric pressure above the liquid, then the gas bubbles collapse and the particles within the bubbles return to the liquid state. However, if the vapour pressure of these micro-bubbles equals or exceeds the atmospheric pressure above the liquid, then the bubbles become larger and rise to the surface as the pressure on the bubbles become less.

As the temperature of the liquid increases, more micro-bubbles form because more particles have enough energy to change phase. The temperature at which the vapour pressure of the liquid equals the atmospheric pressure above the liquid is called the *boiling point*. *Normal boiling point* occurs when the atmospheric pressure above the liquid is standard pressure (1 atmosphere, 101.3 kilopascals [kPa], or 760 mm of mercury).

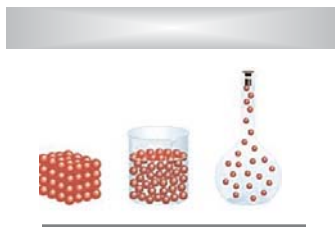

**SPECIFIC LEARNING OUTCOMES**

**C11-1-07:** Operationally define normal boiling point temperature in terms of vapour pressure.

(continued)

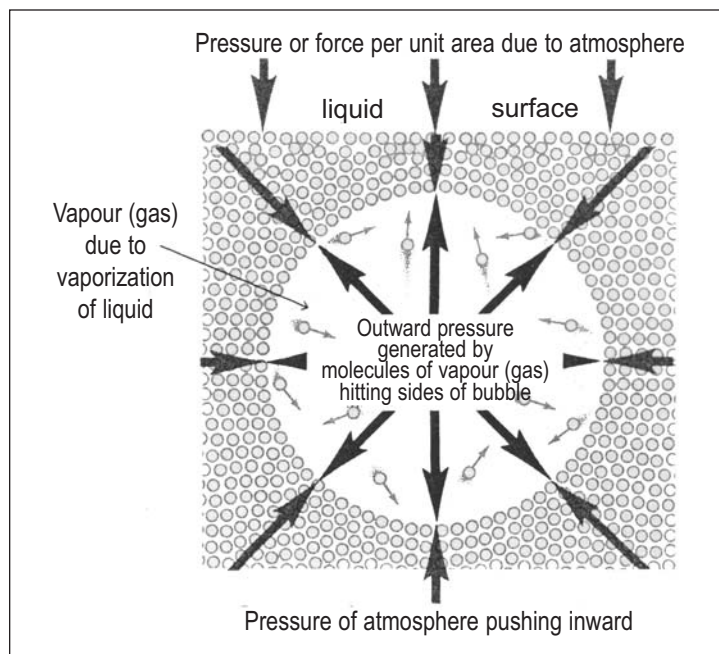

**Bubble in a boiling liquid.**

**Figure:** From *Chemistry: Experimental Foundations* by Robert W. Parry, Phyllis M. Dietz, Robert L. Tellefsen, & Luke E. Steiner © 1975 by Prentice Hall. Used by permission of Pearson Education, Inc.

**Class Discussion**

Wherever possible, have students use the Kinetic Molecular Theory in their explanations for the following discussions.

1. Compare the rates of evaporation for various liquids and correlate these with the vapour pressure and with the normal boiling temperature.
2. Discuss camp cooking at higher elevations.
3. Discuss the operation of a pressure cooker.
4. Predict the effect on boiling point of adding a solute, such as salt (learning outcome C11-4-11).

**SKILLS AND ATTITUDES OUTCOME****C11-0-U2:** Demonstrate an understanding of chemical concepts.

*Examples: use accurate scientific vocabulary, explain concepts to others, compare and contrast concepts, apply knowledge to new situations and/or contexts, create analogies, use manipulatives...*

---

**SUGGESTIONS FOR ASSESSMENT**

---

**Rubrics/Checklists**

See Appendix 10 for a variety of rubrics and checklists that can be used for self-assessment, peer assessment, and teacher assessment.

**Visual Displays**

Students could present their ideas of the boiling process visually in terms of particles. They could use the following to illustrate their ideas:

- posters
- pamphlets
- bulletin boards
- models
- multimedia

**Paper-and-Pencil Tasks**

Ask student to use the Kinetic Molecular Theory to

1. explain the process of boiling
2. explain how boiling would be affected by the addition of a solute to the liquid
3. explain how atmospheric pressure would affect boiling

**Journal Writing**

Have students reflect on the effect of reduced atmospheric pressure on boiling. Would mountaineers be able to boil water close to the top of Mount Everest?

**LEARNING RESOURCES LINKS**

---



*Chemistry* (Chang 464)

*Chemistry* (Zumdahl and Zumdahl 491)

*Chemistry: The Central Science* (Brown, et al. 425)

*Chemistry: Concepts and Applications* (Phillips, Strozak, and Wistrom 358)

*Chemistry: The Molecular Nature of Matter and Change* (Silberberg 428)

*Glencoe Chemistry: Matter and Change* (Dingrando, et al. 406)

*Introductory Chemistry: A Foundation* (Zumdahl 400)

*Prentice Hall Chemistry: Connections to Our Changing World* (LeMay, et al. 483)



## SPECIFIC LEARNING OUTCOME

**C11-1-08:** Interpolate and extrapolate the vapour pressure and boiling temperature of various substances from pressure versus temperature graphs.

(1.5 hours)

SLO: C11-1-08

## SUGGESTIONS FOR INSTRUCTION

## Entry-Level Knowledge

Students may be familiar with the term *vapour*, but not in the context of the Kinetic Molecular Theory and vaporization. Other learning outcomes in Topic 1 of Grade 11 Chemistry have prepared students for learning outcome C11-1-08.

## Assessing Prior Knowledge

Check for student understanding of prior knowledge and review as necessary. Prior knowledge can be reviewed and/or assessed by using any of the KWL strategies (e.g., Concept Map, Knowledge Chart, Think-Pair-Share – see *SYSTH*, Chapter 9).

## TEACHER NOTES

This learning outcome provides students with an opportunity to apply the concepts they have learned in learning outcomes C11-1-05, C11-1-06, and C11-1-07.

The vapour pressure of a given liquid is inversely proportional to the strength of the intermolecular forces of attraction. The vapour pressure is also related to the average kinetic energy of the liquid. Students know that if the pressure above the liquid is decreased to the vapour pressure of the liquid at that temperature, the liquid will boil according to the operational definition of boiling. Students should then understand that liquids will boil at almost any temperature if the atmospheric pressure above the liquid is low enough.

## Activities

1. Have students examine the following data table, Vapour Pressure of Some Liquids. Many chemistry texts provide similar data. If teachers prefer the data in kPa, the following conversion factor can be used:

$$\text{mmHg} \times 0.133322 \text{ kPa/mmHg} = \text{kPa}$$

$$\text{mmHg} \times 1.3579 \times 10^3 \text{ atm/mmHg} = \text{atm}$$

## General Learning Outcome Connections

- GLO A2:** Recognize that scientific knowledge is based on evidence, models, and explanations, and evolves as new evidence appears and new conceptualizations develop.
- GLO C2:** Demonstrate appropriate scientific inquiry skills when seeking answers to questions.
- GLO E2:** Describe and appreciate how the natural and constructed world is made up of systems and how interactions take place within and among these systems.
- GLO E4:** Recognize that energy, whether transmitted or transformed, is the driving force of both movement and change, and is inherent within materials and in the interactions among them.

## SKILLS AND ATTITUDES OUTCOMES

**C11-0-U2:** Demonstrate an understanding of chemical concepts.

*Examples: use accurate scientific vocabulary, explain concepts to others, compare and contrast concepts, apply knowledge to new situations and/or contexts, create analogies, use manipulatives...*

**C11-0-S7:** Interpret patterns and trends in data, and infer and explain relationships.

Vapour Pressures of Some Liquids				
Temp. (°C)	Water (mmHg)	Ethyl Alcohol (mmHg)	Dimethyl Ether (mmHg)	Ethylene Glycol (mmHg)
0	5	12	175	
10	9	24	300	
20	18	44	450	
30	32	79	700	
40	55	135	1000	
50	93	222		
60	149	352		2
70	234	543		4
80	355	813		12
90	526	1187		24
100	760	1693		60

**Reference:** Parry, Robert W., *et al. Chemistry: Experimental Foundations*. Englewood Cliffs, NJ: Prentice-Hall, Inc., 1975. 106.

- Ask students to graph the data either manually using metric graph paper or by using a graphing program. A sample plot appears below.

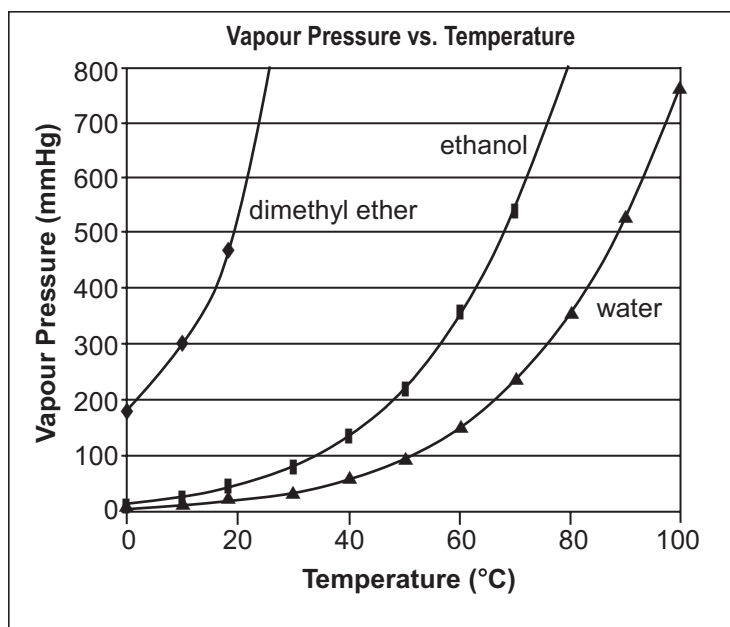



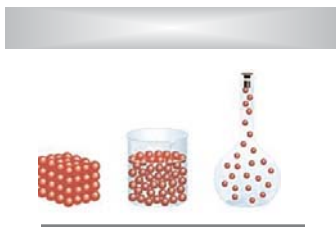

### SPECIFIC LEARNING OUTCOME

**C11-1-08:** Interpolate and extrapolate the vapour pressure and boiling temperature of various substances from pressure versus temperature graphs.

(continued)



### SUGGESTIONS FOR ASSESSMENT

#### Discussion Questions

The following are examples of questions for class discussion:

- What is the vapour pressure (VP) of ethyl alcohol at 40°C? (135 mmHg)
- Which substance would evaporate the slowest at 20°C? Explain your reasoning. (ethylene glycol – lowest VP at any temperature)
- Which substance has the least intermolecular forces of attraction? Explain your reasoning. (dimethyl ether – greatest VP at any temperature)
- List substances in increasing order of intermolecular forces. (dimethyl ether, ethanol, water, ethylene glycol)
- Which substance would have the least viscosity at 20°C? Explain your reasoning. (dimethyl ether – most volatile, least forces)
- Determine the atmospheric pressure required to have dimethyl ether boil at 20°C. (450 mmHg)

#### Topic-Review Activity

An activity game has been designed to review the material in Topic 1: Physical Properties of Matter. For details, see Appendix 1.14: Chemistry Is Super: “Bingo” Review Game.

### LEARNING RESOURCES LINKS



*Chemistry* (Chang 464)

*Chemistry* (Zumdahl and Zumdahl 486)

*Chemistry: The Central Science* (Brown, et al. 425)

*Chemistry: The Molecular Nature of Matter and Change* (Silberberg 428)

**SKILLS AND ATTITUDES OUTCOMES**

**C11-0-U2:** Demonstrate an understanding of chemical concepts.

*Examples: use accurate scientific vocabulary, explain concepts to others, compare and contrast concepts, apply knowledge to new situations and/or contexts, create analogies, use manipulatives...*

**C11-0-S7:** Interpret patterns and trends in data, and infer and explain relationships.

---

**NOTES**



## TOPIC 2: GASES AND THE ATMOSPHERE

---





## Topic 2: Gases and the Atmosphere

- C11-2-01** Identify the abundances of the naturally occurring gases in the atmosphere and examine how these abundances have changed over geologic time.  
Include: oxygenation of Earth's atmosphere, the role of biota in oxygenation, changes in carbon dioxide content over time
- C11-2-02** Research Canadian and global initiatives to improve air quality.
- C11-2-03** Examine the historical development of the measurement of pressure.  
*Examples: the contributions of Galileo Galilei, Evangelista Torricelli, Otto von Guericke, Blaise Pascal, Christiaan Huygens, John Dalton, Joseph Louis Gay-Lussac, Amadeo Avogadro...*
- C11-2-04** Describe the various units used to measure pressure.  
Include: atmospheres (atm), kilopascals (kPa), millimetres of mercury (mmHg), millibars (mb)
- C11-2-05** Experiment to develop the relationship between the pressure and volume of a gas using visual, numeric, and graphical representations.  
Include: historical contributions of Robert Boyle
- C11-2-06** Experiment to develop the relationship between the volume and temperature of a gas using visual, numeric, and graphical representations.  
Include: historical contributions of Jacques Charles, the determination of absolute zero, the Kelvin temperature scale
- C11-2-07** Experiment to develop the relationship between the pressure and temperature of a gas using visual, numeric, and graphical representations.  
Include: historical contributions of Joseph Louis Gay-Lussac
- C11-2-08** Solve quantitative problems involving the relationships among the pressure, temperature, and volume of a gas using dimensional analysis.  
Include: symbolic relationships
- C11-2-09** Identify various industrial, environmental, and recreational applications of gases.  
*Examples: self-contained underwater breathing apparatus (scuba), anaesthetics, air bags, acetylene welding, propane appliances, hyperbaric chambers...*

**Suggested Time: 10.5 hours**



**SPECIFIC LEARNING OUTCOME**

**C11-2-01:** Identify the abundances of the naturally occurring gases in the atmosphere and examine how these abundances have changed over geologic time.

Include: oxygenation of Earth's atmosphere, the role of biota in oxygenation, changes in carbon dioxide content over time

(1.5 hours)

SLO: C11-2-01

**SUGGESTIONS FOR INSTRUCTION****Entry-Level Knowledge**

The following learning outcomes were addressed in Grade 10 Science:

- S2-1-01: Illustrate and explain how carbon, nitrogen, and oxygen are cycled through an ecosystem.
- S2-4-01: Illustrate the composition and organization of the hydrosphere and atmosphere.

**Assessing Prior Knowledge**

Check for student understanding of prior knowledge and review as necessary. Prior knowledge can be reviewed and/or assessed by using any of the KWL strategies (e.g., Concept Map, Knowledge Chart, Think-Pair-Share—see *SYSTH*, Chapter 9).

**TEACHER NOTES**

Most chemistry texts provide a list of the components of the atmosphere, but few of them actually discuss how the composition has changed over geologic time.

It is generally believed that the composition of the atmosphere was dramatically different before life began on Earth than it is today, and was likely dominated by nitrogenous gases and significantly greater amounts of CO<sub>2</sub> than at present. Billions of years ago, the atmosphere consisted mainly of ammonia, methane, and water vapour. It is generally accepted that little free molecular oxygen existed. Ultraviolet radiation from the sun penetrated the relatively dense atmosphere and provided the energy for chemical reactions that eventually led to the emergence of key “biomolecules” (e.g., amino acids) consistent with the foundations of new life on Earth.

**General Learning Outcome Connections**

- GLO B3:** Identify the factors that affect health, and explain the relationships among personal habits, lifestyle choices, and human health, both individual and social.
- GLO B4:** Demonstrate knowledge of and personal consideration for a range of possible science- and technology-related interests, hobbies, and careers.
- GLO D5:** Understand the composition of the Earth's atmosphere, hydrosphere, and lithosphere, as well as the processes involved within and among them.
- GLO E3:** Recognize that characteristics of materials and systems can remain constant or change over time, and describe the conditions and processes involved.

**SKILLS AND ATTITUDES OUTCOMES**

**C11-0-S5:** Collect, record, organize, and display data using an appropriate format.

*Examples: labelled diagrams, graphs, multimedia applications, software integration, probeware...*

**C11-0-R1:** Synthesize information obtained from a variety of sources.

Include: print and electronic sources, specialists, other resource people

**C11-0-R2:** Evaluate information obtained to determine its usefulness for information needs.

*Examples: scientific accuracy, reliability, currency, relevance, balance of perspectives, bias...*

**C11-0-R4:** Compare diverse perspectives and interpretations in the media and other information sources.

**C11-0-R5:** Communicate information in a variety of forms appropriate to the audience, purpose, and context.

---

Origin-of-life models have generally proposed that about 1 billion years after the first primitive organisms emerged, blue-green algae appeared on Earth. These algae converted the existing carbon dioxide and water to free oxygen gas and glucose through the well-known process of *photosynthesis*. These photo-synthesizers were also responsible for helping to bind atmospheric hydrogen into carbonates and water.

Another important source of oxygen was the photo-decomposition of water vapour by ultraviolet light. As the amount of free oxygen increased, an ozone layer began to form high in the stratosphere due to the dissociation of molecular oxygen and subsequent recombination as O<sub>3</sub> (ozone). Ozone proved important in filtering out potentially damaging amounts of ultraviolet radiation and allowing for the development of more complex species. As further carbon was extracted from the atmosphere, early life forms provided a food supply that fuelled the progress of evolution. Through their death and decay, particularly in the world's oceans, early life forms not only laid down vast quantities of fossilized minerals, but also sequestered large quantities of carbon in the form of thick sequences of carbonate rocks. An estimate of the amount of atmospheric carbon that was extracted by this method has been proposed at  $1 \times 10^{13}$  tonnes.

**Activities**

A number of activities that involve graphing carbon dioxide levels over the last two centuries can be found in the appendices of *Senior 2 Science: A Foundation for Implementation* (see Appendix 4.35). A graphing activity from page A205 of this document follows.





## SPECIFIC LEARNING OUTCOME

**C11-2-01:** Identify the abundances of the naturally occurring gases in the atmosphere and examine how these abundances have changed over geologic time.

Include: oxygenation of Earth's atmosphere, the role of biota in oxygenation, changes in carbon dioxide content over time

(continued)

Carbon Dioxide CO <sub>2</sub> Concentrations in the Atmosphere and Temperature Changes (Anomaly) from 1840 to 2000		
Year	CO <sub>2</sub> Concentration (parts per million of volume [ppmv]*)	Temperature Anomaly (°C above/below normal)
1840	280	-0.40
1955	310	-0.05
1960	312	0.00
1965	316	-0.10
1970	320	-0.08
1975	327	-0.08
1980	335	-0.08
1985	345	+0.10
1990	352	+0.15
1995	355	+0.25
2000	360	+0.28

\* 300 ppmv (300 parts per million by volume) is equivalent to 300 CO<sub>2</sub> molecules/1,000,000 molecules of dry air, or, expressed as a percent, 0.03%.

Data courtesy of Environment Canada <<http://www.ec.gc.ca>>. Copyright © 2001.

Students use the data from the table above to plot the year against the concentrations of carbon dioxide to show how the concentrations have changed from 1840 to 2000. The graphs could be drawn manually using graph paper. Another option would be for students to plot their graphs using a plotting program such as *Curve Expert*<sup>®</sup>, *Mathematica*<sup>®</sup>, or *Graphical Analysis 3*<sup>®</sup> by Vernier. Students should gain reinforcement in drawing the “best fit” curve that helps to determine a relationship, and discussing the results of the plot and any correlations that may be evident in the graph. The extent to which the analysis is treated would be determined by the mathematical experience of students in the class and the availability of class time and computer access.



## SUGGESTIONS FOR ASSESSMENT

## Rubrics/Checklists

See Appendix 10 for a selection of rubrics and checklists that can be used for self-assessment, peer assessment, and teacher assessment.

**SKILLS AND ATTITUDES OUTCOMES**

**C11-0-S5:** Collect, record, organize, and display data using an appropriate format.

*Examples: labelled diagrams, graphs, multimedia applications, software integration, probeware...*

**C11-0-R1:** Synthesize information obtained from a variety of sources.

Include: print and electronic sources, specialists, other resource people

**C11-0-R2:** Evaluate information obtained to determine its usefulness for information needs.

*Examples: scientific accuracy, reliability, currency, relevance, balance of perspectives, bias...*

**C11-0-R4:** Compare diverse perspectives and interpretations in the media and other information sources.

**C11-0-R5:** Communicate information in a variety of forms appropriate to the audience, purpose, and context.

---

**Research Reports**

Have students conduct independent research towards achieving the specific learning outcome (C11-2-01) related to the composition of Earth's atmosphere over geologic time. Reporting can be done either individually or in cooperative groups. The information collected could be presented as

- written reports
- oral presentations
- bulletin board displays
- multimedia presentations
- a simulated scientific meeting
- a debate involving contested views on the history of Earth's atmospheric composition

**Visual Displays**

Students could present the material they have collected using

- posters
- pamphlets
- bulletin boards
- models

Each of these presentation styles could be assessed using an appropriate rubric created with students prior to the assignment. A sample of a class presentation rubric is provided in Appendix 10 (also see *SYSTH* 14.15).

**LEARNING RESOURCES LINKS**

---



*Chemistry* (Chang 732)

*Chemistry: The Molecular Nature of Matter and Change* (Silberberg 206)

*McGraw-Hill Ryerson Chemistry 11, Ontario Edition* (Mustoe, et al. 458)

**SPECIFIC LEARNING OUTCOME**

**C11-2-02:** Research Canadian and global initiatives to improve air quality.

(1.0 hour)

SLO: C11-2-02

**SUGGESTIONS FOR INSTRUCTION****Entry-Level Knowledge**

The following learning outcomes were addressed in Grade 10 Science:

- S2-4-07: Investigate and evaluate evidence that climate change occurs naturally and can be influenced by human activities.
- S2-4-08: Discuss potential consequences of climate change.

**Assessing Prior Knowledge**

Check for understanding of prior knowledge and review as necessary. Prior knowledge can be reviewed and/or assessed by using any of the KWL strategies (e.g., Concept Map, Knowledge Chart, Think-Pair-Share – see *SYSTH*, Chapter 9).

**TEACHER NOTES**

Numerous websites, such as those listed below, detail Canadian and global initiatives to mitigate the effects of global warming and its potential connections to overall climate instability.



World Health Organization. Protection of the Human Environment:

<<http://www.who.int/phe/en/>>

This website provides a starting point to research global initiatives related to human health, the environment, and sustaining healthy living.

Natural Resources Canada. Climate Change in Canada. Teacher's Guide:

<[http://adaptation.nrcan.gc.ca/posters/teachers/resourc\\_e.asp](http://adaptation.nrcan.gc.ca/posters/teachers/resourc_e.asp)>

This website offers a series of well-researched poster-style panels that detail the implications of changing climate in various regions of Canada. The posters can be ordered in hard copy for classroom use or viewed online. There are lesson

**General Learning Outcome Connections**

- GLO B5:** Identify and demonstrate actions that promote a sustainable environment, society, and economy, both locally and globally.
- GLO C6:** Employ effective communication skills and use information technology to gather and share scientific and technological ideas and data.
- GLO D5:** Understand the composition of the Earth's atmosphere, hydrosphere, and lithosphere, as well as the processes involved within and among them.
- GLO E2:** Describe and appreciate how the natural and constructed world is made up of systems and how interactions take place within and among these systems.
- GLO E3:** Recognize that characteristics of materials and systems can remain constant or change over time, and describe the conditions and processes involved.

**SKILLS AND ATTITUDES OUTCOMES**

- C11-0-R1:** Synthesize information obtained from a variety of sources.  
 Include: print and electronic sources, specialists, other resource people
- C11-0-R2:** Evaluate information obtained to determine its usefulness for information needs.  
*Examples: scientific accuracy, reliability, currency, relevance, balance of perspectives, bias...*
- C11-0-R4:** Compare diverse perspectives and interpretations in the media and other information sources.
- C11-0-R5:** Communicate information in a variety of forms appropriate to the audience, purpose, and context.
- 

plans for the poster series developed from learning outcomes in the *Common Framework of Science Learning Outcomes K to 12: Pan-Canadian Protocol for Collaboration on School Curriculum* (Council of Ministers of Education, Canada). This Government of Canada website provides information on actions related to clean air.

Environment Canada. Clean Air Online: <<http://www.ec.gc.ca/cleanair-airpur/>>  
 This website describes and provides information on various pollutants, including smog, acid rain, ground-level ozone, particulate matter, persistent organic matter, and mercury. It describes sources and effects of pollution and provides an air quality forecast.

---. ---. Science and Research: <[http://www.ec.gc.ca/cleanair-airpur/Science\\_and\\_Research-WS955E8065-1\\_En.htm](http://www.ec.gc.ca/cleanair-airpur/Science_and_Research-WS955E8065-1_En.htm)>  
 This website provides a navigation bar that links to a variety of federal government initiatives, current research, and legislation related to air quality.

---. The CEPA Environmental Registry: <<http://www.ec.gc.ca/CEPARegistry/>>  
 In 1999, the Government of Canada introduced its 10-year Action Plan on Clean Air as a commitment to improve air quality. Through the efforts of the provinces, territories, and the private sector, the Government of Canada hopes to develop the awareness of and means to lessen industrial emissions and work toward a cleaner environment for Canadians.

Canada's 10-year Action Plan on Clean Air was intended to address these areas of science, standards, and public policy:

- *Canadian Environmental Protection Act (CEPA) 1999*
- science, reporting, and monitoring
- vehicles and fuels
- Canada-wide standards
- international agreements
- infrastructure
- acid rain

Information on international initiatives related to global climate change can be obtained by using search engine keywords such as "Clean Air Initiative," "CAI," and "Kyoto Protocol."

**SPECIFIC LEARNING OUTCOME****C11-2-02:** Research Canadian and global initiatives to improve air quality.*(continued)*

---

The Kyoto Protocol has sharpened the focus of the role of forests in contributing to or mitigating climate change. Forested ecosystems, including both above and below soil-surface biomass, are large storehouses of carbon. Growing new forests can extract CO<sub>2</sub> from the atmosphere, and should, therefore, help in mitigating the potential warming effects from excess human production of CO<sub>2</sub>.

**Activities**

Have students access websites for information on current initiatives in engaging citizens to respond to the challenges presented by a future with greater abundances of atmospheric carbon dioxide. Encourage comparisons among Canadian projects and those supported by other countries around the world.

**SUGGESTIONS FOR ASSESSMENT**

---

**Research Reports**

Have students research and report their findings either individually or in small groups. The information collected could be presented as

- written reports
- oral presentations
- bulletin board displays
- multimedia presentations

**Visual Displays**

Students could present the material they have collected using

- posters
- pamphlets
- bulletin boards
- models

Each of these presentation styles could be assessed using an appropriate rubric created with students prior to the assignment. A sample of a presentation rubric is provided in Appendix 10 of this document.

**SKILLS AND ATTITUDES OUTCOMES**

- C11-0-R1:** Synthesize information obtained from a variety of sources.  
Include: print and electronic sources, specialists, other resource people
- C11-0-R2:** Evaluate information obtained to determine its usefulness for information needs.  
*Examples: scientific accuracy, reliability, currency, relevance, balance of perspectives, bias...*
- C11-0-R4:** Compare diverse perspectives and interpretations in the media and other information sources.
- C11-0-R5:** Communicate information in a variety of forms appropriate to the audience, purpose, and context.
- 

**Journal Writing**

Specific learning outcome C11-2-02 (similar to C11-2-01) directly connects to the personal lifestyles of students and their future behaviour as energy consumers. In their journals, students can reflect on the causes and consequences of poor air quality and the difficulties with implementing global regulations or the tenets of signed agreements such as the Kyoto Protocol of 1997. Such international cooperation and the eventual implementation of agreements combine complex social, political, and scientific dimensions. As such, they present worthwhile STSE decision-making issues for classroom discussion.

**Paper-and-Pencil Tasks**

Once students have completed the activities for this leaning outcome, they should be able to answer questions such as the following:

- What are some of the air pollutants about which we are most concerned?
- Why are these pollutants so much of a concern?
- What evidence is there that the concern is real?
- What is the Government of Canada doing to monitor air quality?
- How and where is air quality measured in Canada?
- What is the Kyoto Accord? When was it signed? Has Canada adopted specific targets for the reduction of CO<sub>2</sub> from industrial and domestic uses of fossil fuels?
- What governments have not yet signed the Kyoto Accord? (As of 2006, Australia, China, and the United States were non-signatories.)
- Are there justifiable reasons for delaying adoption of the Kyoto Accord based on sound scientific evidence?
- What other, non-scientific reasons would a government have for not signing such an environmental accord?
- What was the nature of the Montreal Declaration of 2005, signed by more than a hundred nations?

**SPECIFIC LEARNING OUTCOME****C11-2-02:** Research Canadian and global initiatives to improve air quality.*(continued)*

---

**Climate Science Debate**

The scientific community of atmospheric scientists and climatologists is far from reaching consensus on the implications of a planet with higher levels of CO<sub>2</sub>. What is abundantly clear, however, is that the concentrations of carbon dioxide, methane, and certain other greenhouse-enhancing gases are rising steadily. Records of past atmospheric concentrations of these species (principally from ice core research) demonstrate that there have been episodes in the past 400 000 years when concentrations of CO<sub>2</sub> have been higher than present levels. What is different about the current epoch is the rate of change in the CO<sub>2</sub> levels. The global results of such a rapid increase in atmospheric CO<sub>2</sub> is a great unknown.



It is important for students to conduct research that is fair and representative of alternative, and viable, scientific viewpoints on such a vital issue. Students should research climate science, as articulated by organizations such as The Friends of Science – Providing Insight into Climate Science (see <<http://www.friendsofscience.org/>>). This large, international community of climate scientists, for instance, holds views quite contrary to what has been supported by Environment Canada and the United Nations' (UN) Intergovernmental Panel on Climate Change (IPCC) over the past decade.

Most Canadian climatologists take their research lead from the World Meteorological Organization (WMO), which is a UN-sponsored climate and weather science working group. The IPCC acts under the auspices of the UN and WMO. The IPCC website, located at <<http://www.ipcc.ch/>>, is a massive portal to the latest research in climate science, and contains pages for general consumption, as well as a significant body of technical publications. For instance, a number of presentation-quality graphics for classroom use are available at <<http://www.ipcc.ch/present/presentations.htm>>.

Students could role-play disparate points of view within the climate science community. Alternatively, local science faculty could bring expert interventions into the classroom. Staff of the Department of Geography at The University of Winnipeg and Environment Canada can be helpful in this outreach capacity. Insight into controversial issues, as discussed among scientific “experts,” is one of the hallmarks of sound, rational scientific debate. Engage students in such debate, where appropriate.

#### SKILLS AND ATTITUDES OUTCOMES

- C11-0-R1:** Synthesize information obtained from a variety of sources.  
Include: print and electronic sources, specialists, other resource people
- C11-0-R2:** Evaluate information obtained to determine its usefulness for information needs.  
*Examples: scientific accuracy, reliability, currency, relevance, balance of perspectives, bias...*
- C11-0-R4:** Compare diverse perspectives and interpretations in the media and other information sources.
- C11-0-R5:** Communicate information in a variety of forms appropriate to the audience, purpose, and context.
- 

#### LEARNING RESOURCES LINKS

---



*Chemistry* (Chang 732)

*Chemistry: The Molecular Nature of Matter and Change* (Silberberg 206)

*McGraw-Hill Ryerson Chemistry 11, Ontario Edition* (Mustoe, et al. 458)

*Nelson Chemistry 12: College Preparation, Ontario Edition* (Davies, et al. 343)





### SPECIFIC LEARNING OUTCOMES

**C11-2-03:** Examine the historical development of the measurement of pressure.

*Examples: the contributions of Galileo Galilei, Evangelista Torricelli, Otto von Guericke, Blaise Pascal, Christiaan Huygens, John Dalton, Joseph Louis Gay-Lussac, Amadeo Avogadro...*

**C11-2-04:** Describe the various units used to measure pressure.

Include: atmospheres (atm), kilopascals (kPa), millimetres of mercury (mmHg), millibars (mb)

(1.0 hour)

SLO: C11-2-03  
SLO: C11-2-04

### SUGGESTIONS FOR INSTRUCTION

#### Entry-Level Knowledge

Students may be familiar with the barometer from discussions of barometric pressure in Grade 10 Science.

#### TEACHER NOTES

A historical treatment of the development of devices to measure gas pressure is important for students to understand the progress of applications of scientific principles.

#### Discrepant Event

Can you vacuum pack a student? A powerful domestic vacuum cleaner and a large heavy-gauge plastic garbage bag can be used to demonstrate a particularly interesting approach to changes in air pressure, as described in Appendix 2.1: Can You Vacuum Pack a Person? Have a student volunteer climb into the bag and sit down (this works best if the student is less than 170 cm tall). Gather the bag around the student's neck underneath the chin and insert the narrow tubular upholstery attachment into the gathered bag. Make sure the student can breathe easily! Have the student cup the end of the attachment to prevent the bag from getting sucked into the attachment. Turn on the vacuum cleaner. A significant enough vacuum will be created to immobilize the student. The student may fall over! **Use caution throughout.**

#### General Learning Outcome Connections

- GLO A2:** Recognize that scientific knowledge is based on evidence, models, and explanations, and evolves as new evidence appears and new conceptualizations develop.
- GLO A4:** Identify and appreciate contributions made by women and men from many societies and cultural backgrounds that have increased our understanding of the world and brought about technological innovations.
- GLO A5:** Recognize that science and technology interact with and advance one another.
- GLO B1:** Describe scientific and technological developments—past and present—and appreciate their impact on individuals, societies, and the environment, both locally and globally.
- GLO B2:** Recognize that scientific and technological endeavours have been and continue to be influenced by human needs and the societal context of the time.

**SKILLS AND ATTITUDES OUTCOMES**

**C11-0-U1:** Use appropriate strategies and skills to develop an understanding of chemical concepts.

*Examples: analogies, concept frames, concept maps, manipulatives, particulate representations, role-plays, simulations, sort-and-predict frames, word cycles...*

**C11-0-U2:** Demonstrate an understanding of chemical concepts.

*Examples: use accurate scientific vocabulary, explain concepts to others, compare and contrast concepts, apply knowledge to new situations and/or contexts, create analogies, use manipulatives...*

---

**Timeline Activity**

The activity described in Appendix 2.2: A Historical Timeline of the Measurement of Pressure enables students to appreciate more clearly the historical timeline of the scientists identified in the following Teacher Notes. When creating the timeline, students could refer to the Peer-Assessment Rubric provided with Appendix 2.2.

**TEACHER NOTES**

The information presented here is a summary of texts and other resources.

- **1564–1642: Galileo Galilei** developed the suction pump. He used air to draw underground water up a column, similar to how a syringe draws water. He was perplexed as to why there was a limit to the height water could be raised.
- **1643: Evangelista Torricelli** developed the first barometer. He carried on Galileo’s work by determining that the limit to the height Galileo’s pump could draw water was due to atmospheric pressure. He invented a closed-end tube filled with mercury that, in turn, was suspended in a shallow dish filled with liquid mercury. The height of the column of mercury in the tube (measured in mmHg) was equal to the atmospheric pressure acting on the mercury in the pan.
- **1643–1645: Otto von Guericke** made a pump that could create a vacuum so strong that a team of 16 horses could not pull two metal hemispheres apart. He reasoned that the hemispheres were held together by the mechanical force of the atmospheric pressure rather than the vacuum. (**Note:** Point out to students that vacuums don’t “suck” – it is the force of the atmosphere that pushes. This demonstration can be reproduced by forcing two bathroom plungers together and having students attempt to pull them apart.)
- **1648: Blaise Pascal** used Torricelli’s “barometer” and travelled up and down a mountain in southern France. He discovered that the pressure of the atmosphere increased as he moved down the mountain. Sometime later the SI unit of pressure, the Pascal, was named after him.
- **1661: Christiaan Huygens** developed the manometer to study the elastic forces in gases.
- **1801: John Dalton** stated that in a mixture of gases the total pressure is equal to the sum of the pressure of each gas, as if it were in a container alone. The pressure exerted by each gas is called its partial pressure.
- **1808: Joseph Louis Gay-Lussac** observed the law of combining volumes. He noticed that, for example, two volumes of hydrogen combined with one volume of oxygen to form two volumes of water.



## SPECIFIC LEARNING OUTCOMES

**C11-2-03:** Examine the historical development of the measurement of pressure.

*Examples: the contributions of Galileo Galilei, Evangelista Torricelli, Otto von Guericke, Blaise Pascal, Christiaan Huygens, John Dalton, Joseph Louis Gay-Lussac, Amadeo Avogadro...*

**C11-2-04:** Describe the various units used to measure pressure.

Include: atmospheres (atm), kilopascals (kPa), millimetres of mercury (mmHg), millibars (mb)

(continued)

- **1811: Amadeo Avogadro** suggested, from Gay-Lussac's experiments conducted three years earlier, that the pressure in a container is directly proportional to the number of particles in that container (known as Avogadro's Hypothesis). This can be illustrated by blowing up a balloon, ball, or tire: the more air is added the larger the container becomes due to increased pressure. (**Note:** Avoid any mention of the mole or pressure-volume-temperature relationships at this time.)

Students were introduced to atmospheric pressure in Grade 10 Science.

Recommended student learning resources often provide pressure measurements in units of kilopascals (kPa). If students used Environment Canada graphs as data sources for weather and climate in Grade 10, they would have been introduced to millibar units.

The *millibar* is a meteorological unit of atmospheric pressure. One bar is equal to standard atmospheric pressure or 1 atm. For purposes of unit conversions, use the conversion  $1 \text{ kPa} = 10 \text{ mb}$ .

The unit *atmosphere* (atm) was derived from standard atmospheric pressure at sea level. One atmosphere is equal to 760 mmHg, or 101.325 kPa. Two atmospheres is twice the standard atmospheric pressure, and so on. The unit mm of mercury is not commonly used today. However, it is used extensively in the science laboratory. Some aneroid barometers found in the home use both mm of mercury and another unit, such as kilopascals.

It is not necessary at this time to have students convert from one pressure unit to another. This can be done during the section on gas law problems (later in Topic 2).

Most students will have experienced the increase in pressure when diving into a swimming pool. Relate the pressure of the atmosphere to the relative pressure of salt water and fresh water.

Chemistry textbooks often present a discussion of pressure as force per unit area. They use, as an example, the pressure exerted by high-heeled shoes compared to the pressure exerted by regular shoes.

**SKILLS AND ATTITUDES OUTCOMES**

**C11-0-U1:** Use appropriate strategies and skills to develop an understanding of chemical concepts.

*Examples: analogies, concept frames, concept maps, manipulatives, particulate representations, role-plays, simulations, sort-and-predict frames, word cycles...*

**C11-0-U2:** Demonstrate an understanding of chemical concepts.

*Examples: use accurate scientific vocabulary, explain concepts to others, compare and contrast concepts, apply knowledge to new situations and/or contexts, create analogies, use manipulatives...*

**Demonstration**

Use a clean, metallic solvent container or can that has a small threaded cap to demonstrate the force of the atmosphere. Boil a small amount of water in the bottom of the container, and then quickly close the cap and cool the closed container. For more impressive results, select a student to come up and gently touch the exterior top of the container as soon as it is sealed, wait a moment, and, as if by “magic,” the container is crushed. Discuss the results in terms of *interior* and *exterior pressure* on the container.

**TEACHER NOTES**

Many certifying agencies for scuba diving can be contacted for information on the physics and physiology of diving. The following table shows the comparison between depths of water and the corresponding pressure of air and water.

Water Pressure Comparison Chart						
Depth				Pressure		
Fresh (ft.)	Fresh (m)	Salt (ft.)	Salt (m)	psi	atm	kPa (approx.)
0	0	0	0	14.7	1.0	100
34	10	33	10	29.4	2.0	200
68	21	66	20	44.1	3.0	300
102	31	99	30	58.8	4.0	400
136	41	132	40	73.5	5.0	500

**Extension:** Show students how to read an open-ended and a closed-ended manometer, if available.



### SPECIFIC LEARNING OUTCOMES

**C11-2-03:** Examine the historical development of the measurement of pressure.

*Examples: the contributions of Galileo Galilei, Evangelista Torricelli, Otto von Guericke, Blaise Pascal, Christiaan Huygens, John Dalton, Joseph Louis Gay-Lussac, Amadeo Avogadro...*

**C11-2-04:** Describe the various units used to measure pressure.

Include: atmospheres (atm), kilopascals (kPa), millimetres of mercury (mmHg), millibars (mb)

(continued)



### SUGGESTIONS FOR ASSESSMENT

#### Rubrics/Checklists

See Appendix 10 for a variety of rubrics and checklists that can be used for self-assessment, peer assessment, and teacher assessment.

#### Research Projects

Students can research the contributions of each of the scientists noted in learning outcome C11-2-03, either individually or as a small group, and present their findings in the form of

- written reports
- oral presentations
- posters
- pamphlets
- bulletin board displays
- multimedia presentations
- website presentations

#### Discussion Questions

Discuss the following questions:

- Scuba divers using compressed air must be very careful not to hold their breath when ascending from a depth, as life-threatening damage to the respiratory system can result. Why might this happen? Explain.
- What is the record for the deepest “free” dive without the use of scuba tanks? How is a free dive possible without damage to the respiratory system?
- What would be another name for a vacuum cleaner?

### SKILLS AND ATTITUDES OUTCOMES

**C11-0-U1:** Use appropriate strategies and skills to develop an understanding of chemical concepts.

*Examples: analogies, concept frames, concept maps, manipulatives, particulate representations, role-plays, simulations, sort-and-predict frames, word cycles...*

**C11-0-U2:** Demonstrate an understanding of chemical concepts.

*Examples: use accurate scientific vocabulary, explain concepts to others, compare and contrast concepts, apply knowledge to new situations and/or contexts, create analogies, use manipulatives...*

---

### Pencil-and-Paper Tasks

Once students have completed the learning activities suggested for learning outcomes C11-2-03 and C11-2-04, they should be able to answer questions such as the following:

- Of the scientists discussed, who in your opinion made the greatest contribution to the understanding of gases? Provide reasons for your choice.
- Why would salt water cause greater pressure for a diver than fresh water?
- What pressure units are generally used most in everyday life?
- How does a barometer differ from a manometer?
- How does an aneroid barometer differ from a mercury barometer? Which one is more accurate? Explain why.
- **Enrichment:** How could we measure the buoyant force of air?

### Journal Entry

Journal topics for discussion could include the following:

- where the various pressure units are used in everyday life
- the “vacuum pack” demonstration
- self-contained underwater breathing apparatus (scuba) diving
- “free” scuba diving
- STSE issues associated with diving

### LEARNING RESOURCES LINKS

---



*Chemistry* (Chang 166)

*Chemistry: The Central Science* (Brown, et al. 367)

*Chemistry: Concepts and Applications* (Phillips, Strozak, and Wistrom 378)

*Chemistry: The Molecular Nature of Matter and Change* (Silberberg 176)

*Glencoe Chemistry: Matter and Change* (Dingrando, et al. 390)

*Introductory Chemistry: A Foundation* (Zumdahl 361)

*McGraw-Hill Ryerson Chemistry 11, Ontario Edition* (Mustoe, et al. 425)

*Nelson Chemistry 11, Ontario Edition* (Jenkins, et al. 424)

*Nelson Chemistry 12: College Preparation, Ontario Edition* (Davies, et al. 331)

*Prentice Hall Chemistry: Connections to Our Changing World* (LeMay, et al. 425)

**SPECIFIC LEARNING OUTCOME**

**C11-2-05:** Experiment to develop the relationship between the pressure and volume of a gas using visual, numerical, and graphical representations.

Include: historical contributions of Robert Boyle

(1.0 hour)

SLO: C11-2-05

**SUGGESTIONS FOR INSTRUCTION****Entry-Level Knowledge**

Students may have no entry-level knowledge other than a mathematical understanding of an inverse proportion relationship and the ability to draw a graph with two variables.

**TEACHER NOTES**

The intent of specific learning outcome C11-2-05 (as well as C11-2-06, C11-2-07, and C11-2-08) is not simply to provide the relationship formulas, but also to have students develop the relationships using visual, numerical, graphical, symbolic, and particulate representations. (For a discussion of these five modes of representation, see Section 2: Implementation of Grade 11 Chemistry.)

**Discrepant Events**

1. An effective way to introduce the gas law, and to illustrate it visually, is with the use of a “drinking bird” apparatus (see Appendix 2.3: The Drinking Bird). This apparatus demonstrates 36 physical properties and laws. Leave the explanation for this event until the end of this sequence of learning outcomes (C11-2-05 to C11-2-08). Once students have been introduced to the remaining learning outcomes, many of them will be able to provide their own explanations. The complete explanation can be found in Appendix 2.3.
2. This event requires either a manual or an electric vacuum pump. When using the pump, ensure that there is sufficient oil in the pump and that a drying tube is attached to the suction side of it. Place marshmallows in the chamber and turn on the pump. When the demonstration is finished, allow air to enter the chamber *before* turning off the pump, or oil may get drawn out of the pump.

**General Learning Outcome Connections**

- GLO A2:** Recognize that scientific knowledge is based on evidence, models, and explanations, and evolves as new evidence appears and new conceptualizations develop.
- GLO A4:** Identify and appreciate contributions made by women and men from many societies and cultural backgrounds that have increased our understanding of the world and brought about technological innovations.
- GLO C4:** Demonstrate appropriate critical thinking and decision-making skills when choosing a course of action based on scientific and technological information.
- GLO C7:** Work cooperatively and value the ideas and contributions of others while carrying out scientific and technological activities.
- GLO C8:** Evaluate, from a scientific perspective, information and ideas encountered during investigations and in daily life.

**SKILLS AND ATTITUDES OUTCOMES**

**C11-0-S5:** Collect, record, organize, and display data using an appropriate format.

Examples: labelled diagrams, graphs, multimedia applications, software integration, probeware...

**C11-0-S7:** Interpret patterns and trends in data, and infer and explain relationships.

**C11-0-S8:** Evaluate data and data-collection methods for accuracy and precision.

Include: discrepancies in data, sources of error, percent error

**C11-0-S9:** Draw a conclusion based on the analysis and interpretation of data.

Include: cause-and-effect relationships, alternative explanations, supporting or rejecting a hypothesis or prediction

**Laboratory Activity**

Students can work toward the development of the relationship between volume and pressure by performing a lab with these two variables in mind. Numerous procedures for conducting such a lab are available in standard chemistry resources. One variation making use of a syringe apparatus is described in *McGraw-Hill Ryerson Chemistry 11* (Mustoe, *et al.* 430).

In this lab activity, a plastic pipette is calibrated to show a change in volume as pressure is applied. The data would then be graphed and a relationship established. Numerical and graphical analyses should be built into the lab activity, in addition to developing an algorithmic relationship based on the non-linear inverse relationship (it is actually a “power law” mathematically and has an analogue in Isaac Newton’s Law of Cooling). A typical graph for an inverse relationship is shown below.

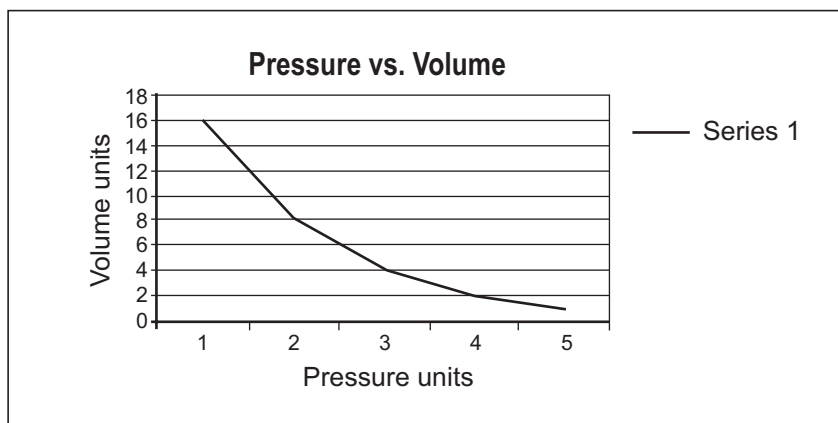

As an alternative activity, students could gain experience with an inverse relationship using syringes and books. This could be done as a demonstration, with students conducting the activity, or as a full lab if enough syringes are available. The syringes usually have a short lifetime because of excessive wear and, over time, produce poor results. The syringes are plugged and held in place by small blocks of wood. When books are placed on a syringe, the plunger is depressed and a reading of the volume can be made that corresponds to the pressure caused by the books.



**SPECIFIC LEARNING OUTCOME**

**C11-2-05:** Experiment to develop the relationship between the pressure and volume of a gas using visual, numerical, and graphical representations.

Include: historical contributions of Robert Boyle

(continued)

**Working with Robert Boyle's Original Data**

Students may find it interesting to model the pressure-volume (P-V) relationship through a comparison of their own experimental data with that recorded in the laboratory notes of Robert Boyle. Here are his results for such a comparison:

**Robert Boyle's Data**

Volume (mL)	Pressure (mmHg)
30.48	739.775
29.21	776.275
27.94	811.2
26.67	850.9
25.4	896.925
24.13	939.8
22.86	998.525
21.59	1057.28
20.32	1122.35
19.05	1195.37
17.78	1277.92
16.51	1379.52
15.24	1493.82
14.605	1557.32
13.97	1627.17
13.335	1703.37
12.7	1795.45
12.065	1882.78
11.43	1978.03
10.795	2101.85
10.16	2232.03
9.525	2363.77
8.89	2551.1
8.255	2738.42
7.62	2986.07

**Graphical Representation**

A graphical representation of Boyle's data follows:

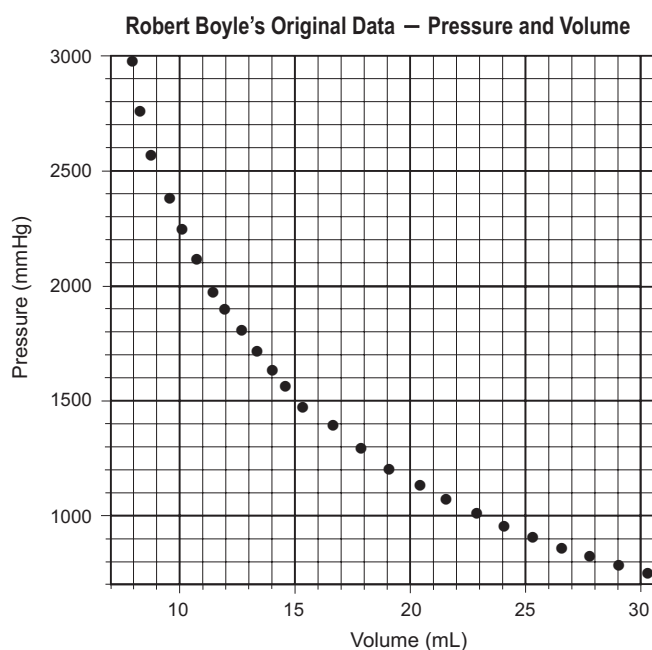

## SKILLS AND ATTITUDES OUTCOMES

**C11-0-S5:** Collect, record, organize, and display data using an appropriate format.

Examples: labelled diagrams, graphs, multimedia applications, software integration, probeware...

**C11-0-S7:** Interpret patterns and trends in data, and infer and explain relationships.

**C11-0-S8:** Evaluate data and data-collection methods for accuracy and precision.

Include: discrepancies in data, sources of error, percent error

**C11-0-S9:** Draw a conclusion based on the analysis and interpretation of data.

Include: cause-and-effect relationships, alternative explanations, supporting or rejecting a hypothesis or prediction

The plot below demonstrates how to “straighten” the curve of the data by recognizing that the original relationship observed was an *inverse* one (i.e., as pressure goes up, volume of the gas sample goes down).

We then test to see whether  $P \times V = \text{constant}$  by re-plotting the data as pressure versus the *inverse* of volume. The straight line indicates that there is indeed a linear relationship between  $P$  and  $1/V$ , and hence we can conclude that  $P_n V_n = \text{constant}$ .

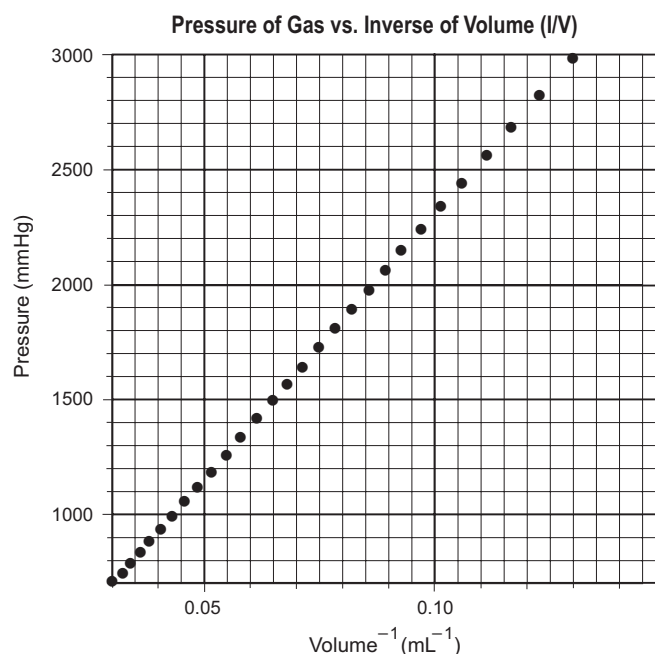

## TEACHER NOTES

Students often have difficulty with inverse mathematical relationships. (Review the discussion of the *modes of representation* in Section 2 of this document.) Have students establish a ratio of the initial and final volumes and ask them to predict what effect this ratio will have on the initial pressure. Will the ratio make the resultant pressure larger or smaller?

**SPECIFIC LEARNING OUTCOME**

**C11-2-05:** Experiment to develop the relationship between the pressure and volume of a gas using visual, numerical, and graphical representations.

Include: historical contributions of Robert Boyle

(continued)

**Sample Problem**

If 3 L of gas is initially at a pressure of 1 atm, what would be the new pressure to cause the volume of the gas to become 0.5 L?

Two ratios are possible to make the units cancel:

$$\text{a) } \frac{3 \text{ L}}{0.5 \text{ L}} \quad \text{or} \quad \text{b) } \frac{0.5 \text{ L}}{3 \text{ L}}$$

According to the experimental results that students would have obtained from the lab activity  $V \propto 1/P$ , if the volume decreases, then the pressure must have increased. In this example, the pressure must have increased, causing the volume to decrease. Therefore, we must multiply by the ratio that would make the answer larger than the initial pressure of 1 atm. Clearly, ratio (a) is the correct one.

Therefore:

$$\frac{3 \cancel{\text{L}}}{0.5 \cancel{\text{L}}} \times 1 \text{ atm} = 6 \text{ atm}$$

After each problem, students should “test” or check their prediction by using logic and the experimental inverse relationship.

*Units of Standard Temperature/Pressure:*

STP (Standard Temperature and Pressure) =  
273 K (0°C), 1 atm (101.3 kPa or 760 mmHg)

*“Room” Conditions:*

298 K (25°C), 1 atm (101.3 kPa or 760 mmHg)

**On a Particulate Level**

Suggest that students use a drawing of a syringe or a bicycle pump filled with dots to represent particles. Have students illustrate what the particles would look like before pressure was applied, and then after. With a smaller volume, the same number of particles will be closer together. This should be related back to the Kinetic Molecular Theory. Have students illustrate their discussions using a Concept Relationship Frame (see SYSTH 11.35).

If probeware is available at school, use lab activities to develop the relationship between pressure and volume. Microscale labs are also excellent means of demonstrating Boyle’s Law and other gas laws.

**SKILLS AND ATTITUDES OUTCOMES**

**C11-0-S5:** Collect, record, organize, and display data using an appropriate format.

Examples: labelled diagrams, graphs, multimedia applications, software integration, probeware...

**C11-0-S7:** Interpret patterns and trends in data, and infer and explain relationships.

**C11-0-S8:** Evaluate data and data-collection methods for accuracy and precision.

Include: discrepancies in data, sources of error, percent error

**C11-0-S9:** Draw a conclusion based on the analysis and interpretation of data.

Include: cause-and-effect relationships, alternative explanations, supporting or rejecting a hypothesis or prediction

Robert Boyle (1627-1691) used a J-shaped glass tube with a sealed end to measure the height of air trapped by mercury that was added to the open end of the tube. After more mercury was added, the height of the trapped air became less. This helped Boyle deduce the relationship between pressure and volume. Robert Boyle and Robert Hooke constructed an air pump to use in their experiments.

**Did You Know?**

Edme Mariotte of France discovered the inverse correlation between volume and pressure independent of Robert Boyle of Ireland. In Australia and the West Indies, Boyle's Law is called Mariotte's Law.

**Teacher Resources**

University of Waterloo. *CHEM 13 NEWS*:

<<http://www.chemistry.uwaterloo.ca/about/outreach/chem13news/index.html>>

Articles in *CHEM 13 NEWS*, an online teacher resource maintained by the University of Waterloo, are useful for discussing the historical development of the gas laws, together with demonstrations and lab activities.

The Physics Hypertext. Thermal Physics. Gas Laws:

<<http://hypertextbook.com/physics/thermal/gas-laws/>>

Maintained by Glenn Elert, this website contains a detailed review of the gas laws, along with additional research material.

**Activity/Demonstration**

1. A Cartesian diver not only illustrates Boyle's Law, but can also be a vehicle for students to demonstrate their ingenuity and creativity. The design for these divers can be simple or complex. Students can have fun with science by making divers and testing them. A number of designs are suggested in Appendix 2.4: Make Your Own Cartesian Diver. This activity provides additional challenges and problems for students to solve, including the creation of variations:

- the sunken diver
- Cartesian retrievers
- Cartesian counters and messages
- diving whirligigs
- closed-system divers

**SPECIFIC LEARNING OUTCOME**

**C11-2-05:** Experiment to develop the relationship between the pressure and volume of a gas using visual, numerical, and graphical representations.

Include: historical contributions of Robert Boyle

(continued)

- density-column divers
  - remote-controlled divers
  - the Cartesian see-saw
  - concentric divers
  - the electric diver
2. If the rubber bulb of a glass eyedropper is partially filled with water, it will become a Cartesian diver when placed into a plastic 2 L pop bottle filled with water. The buoyancy of the “diver” is adjusted until it just floats. When the bottle is squeezed, the volume of the bulb decreases, the density of the diver decreases, and the diver descends.
  3. Large wooden matchsticks can also be used as divers in a similar way. The buoyancy is regulated by cutting off part of a matchstick until it just floats.

**SUGGESTIONS FOR ASSESSMENT****Rubrics/Checklists**

See Appendix 10 for a variety of rubrics and checklists that can be used for self-assessment, peer assessment, and teacher assessment.

**Paper-and Pencil-Tasks**

Students should be able to solve quantitative problems involving pressure and volume using dimensional analysis.

Students should solve pressure versus volume problems using inspection of ratios in order to determine which ratio will give them a plausible answer. Encourage oral expression in class.

**Laboratory Reports**

The activities developed for specific learning outcome C11-2-05 could be assessed either as formal lab reports using the Laboratory Report Format (see *SYSTH* 14.12) or by using questions and answers from the data collected from the various activities.

**SKILLS AND ATTITUDES OUTCOMES**

**C11-0-S5:** Collect, record, organize, and display data using an appropriate format.

*Examples: labelled diagrams, graphs, multimedia applications, software integration, probeware...*

**C11-0-S7:** Interpret patterns and trends in data, and infer and explain relationships.

**C11-0-S8:** Evaluate data and data-collection methods for accuracy and precision.

*Include: discrepancies in data, sources of error, percent error*

**C11-0-S9:** Draw a conclusion based on the analysis and interpretation of data.

*Include: cause-and-effect relationships, alternative explanations, supporting or rejecting a hypothesis or prediction*

**Journal Writing**

Teachers may wish to demonstrate some interesting discrepant events and activities that connect with pressure and volume relationships, thereby providing students with opportunities to reflect on and to construct personalized explanations of the phenomena observed. Students may also have questions whose explanations will come later in Topic 2 of Grade 11 Chemistry.

If students observed The Drinking Bird activity (Appendix 2.3), have them propose explanations as to why it works.

**LEARNING RESOURCES LINKS**

*Chemistry: The Central Science* (Brown, et al. 371)

*Chemistry: Concepts and Applications* (Phillips, Strozak, and Wistrom 383)

*Chemistry with Calculators* (Holmquist and Volz) – Available from Vernier:

<<http://www.vernier.com/chemistry/>>

*Chemistry with Computers* (Holmquist and Volz, Boyle's Law: Pressure-Volume Relationship in Gases) – Available from Vernier:

<<http://www.vernier.com/chemistry/>>

*Glencoe Chemistry: Matter and Change* (Dingrando, et al. 421)

*Glencoe Chemistry: Matter and Change: CBL Laboratory Manual – Teacher Edition* (LAB 4: Boyle's Law, 13)

*Introductory Chemistry: A Foundation* (Zumdahl 363)

*McGraw-Hill Ryerson Chemistry 11, Ontario Edition* (Mustoe, et al. 430)

*Microscale Chemistry Laboratory Manual* (Slater and Rayner-Canham 8)

*Nelson Chemistry 11, Ontario Edition* (Jenkins, et al. 424)

*Nelson Chemistry 12: College Preparation, Ontario Edition* (Davies, et al. 332)

*PASPort Explorations in Chemistry Lab Manual* (PASCO Scientific) – Available from PASCO: <<http://www.pasco.com/hsmanuals/ps2808.html>>

PASCO Scientific. Online Science Experiments. Boyle's Law:

<[http://www.pasco.com/experiments/chemistry/november\\_2001/home.html](http://www.pasco.com/experiments/chemistry/november_2001/home.html)>

*Prentice Hall Chemistry: Connections to Our Changing World* (LeMay, et al. 431)

**SPECIFIC LEARNING OUTCOME**

**C11-2-06:** Experiment to develop the relationship between the volume and temperature of a gas using visual, numerical, and graphical representations.

Include: historical contributions of Jacques Charles, the determination of absolute zero, the Kelvin temperature scale

(2.0 hours)

SLO: C11-2-06

**SUGGESTIONS FOR INSTRUCTION****Entry-Level Knowledge**

Students may be familiar with the barometer from discussions of barometric pressure in Grade 10 Science (Cluster 4: Weather Dynamics).

**TEACHER NOTES**

It is recommended that the relationship between temperature and volume be developed experimentally or by a demonstration in which students collect data and draw their own conclusions. It is not intended that all suggested activities be done. Select the appropriate ones for the class.

**Demonstrations/Laboratory Activities**

Any of the following activities should first be done by the teacher to ensure safety and accuracy of results. Many of these activities are explained in detail as formal lab experiments in various resources.

1. A simple demonstration is to place a balloon over the mouth of an Erlenmeyer flask containing water at room temperature. Place the flask on a hot plate. The balloon will fill as the air in the flask expands. If the flask is cooled with ice, the balloon will be drawn into the flask.
2. Another simple demonstration is to put about 20 mL of water into an empty 255 mL pop can. Place the can on a hot plate or burner. When the water in the can boils, quickly invert the can into a shallow pan of ice-cold water with beaker tongs.

**General Learning Outcome Connections**

- GLO A2:** Recognize that scientific knowledge is based on evidence, models, and explanations, and evolves as new evidence appears and new conceptualizations develop.
- GLO A4:** Identify and appreciate contributions made by women and men from many societies and cultural backgrounds that have increased our understanding of the world and brought about technological innovations.
- GLO C4:** Demonstrate appropriate critical thinking and decision-making skills when choosing a course of action based on scientific and technological information.
- GLO C7:** Work cooperatively and value the ideas and contributions of others while carrying out scientific and technological activities.
- GLO C8:** Evaluate, from a scientific perspective, information and ideas encountered during investigations and in daily life.

## SKILLS AND ATTITUDES OUTCOMES

- C11-0-S7:** Interpret patterns and trends in data, and infer and explain relationships.
- C11-0-S8:** Evaluate data and data-collection methods for accuracy and precision.  
Include: discrepancies in data, sources of error, percent error
- C11-0-S9:** Draw a conclusion based on the analysis and interpretation of data.  
Include: cause-and-effect relationships, alternative explanations, supporting or rejecting a hypothesis or prediction
- C11-0-R1:** Synthesize information obtained from a variety of sources.  
Include: print and electronic sources, specialists, other resource people
- C11-0-R5:** Communicate information in a variety of forms appropriate to the audience, purpose, and context.

3. A more quantitative approach can be taken by inserting both a thermometer and a 20 cm length of glass tubing into a double-holed stopper, as shown in the following diagram. Insert the stopper assembly tightly into a flat- or round-bottomed flask filled to the top with coloured water. As the stopper is inserted, the fluid rises in the glass tubing. Mark the level of the fluid and record the temperature. Then place the flask in a temperature bath, or slowly heat it with a Bunsen burner, and allow the system to equilibrate. By recording the change in volume at a number of temperatures, data can be collected and given to students to graph. A mixture of acetone and dry ice will produce a temperature of approximately  $-78^{\circ}\text{C}$ . Students should plot temperature on the horizontal axis and volume on the vertical axis. By extending the  $x$ -axis to negative values for temperature, students can extrapolate the plotted points down to the temperature axis to obtain an approximate value for 0 K.

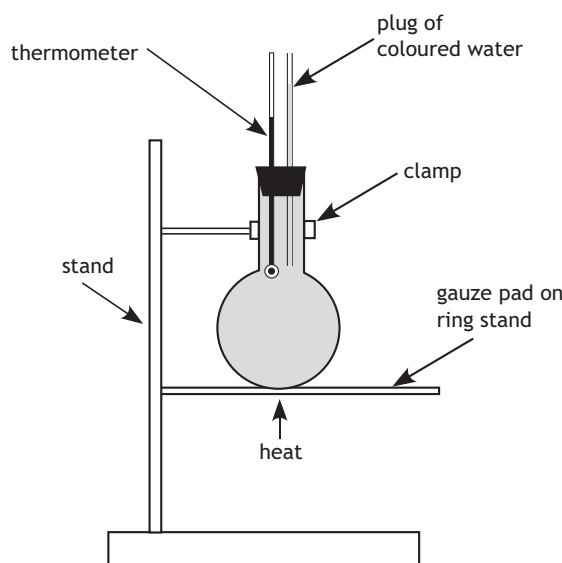

4. The procedure for a lab using syringes can be found in Appendix 2.5: Charles's Law: The Temperature-Volume Relationship in Gases.



**SPECIFIC LEARNING OUTCOME**

**C11-2-06:** Experiment to develop the relationship between the volume and temperature of a gas using visual, numerical, and graphical representations.

Include: historical contributions of Jacques Charles, the determination of absolute zero, the Kelvin temperature scale

(continued)

5. The syringes used in the Boyle's Law activity can be immersed in water at varying temperatures and the volumes measured to give straight-line data for  $V \propto T$ .
6. Probeware can also be used for this activity if the equipment is available.
7. The procedure for a lab using animations on the Internet can be found in Appendix 2.7: Charles's Law Lab.

**Did You Know?**

Since the dawn of civilization, billions of bakers have known about the relationship between temperature and pressure. The precise mathematical relationship of  $V \propto P$  was not described until 1699, however, when it was discovered by French physicist Guillaume Amontons. The experiment was later repeated by Jacques Alexander César Charles in 1787, and much later by Joseph Louis Gay-Lussac in 1802. Charles did not publish his findings, but Gay-Lussac did. The relationship is most frequently called Charles's Law in the British sphere of influence, and Gay-Lussac's Law in the French sphere, but it was never called Amontons's Law.

**TEACHER NOTES**

With the popularity of hot-air balloons in his time, Jacques Charles (1746–1823) investigated the expansion rates of different gases due to temperature changes. Regardless of the gas tested, he found that for every  $1^{\circ}\text{C}$  change, the volume changed  $1/273$ . When the temperature was increased by  $273^{\circ}\text{C}$ , the volume increased by  $546/273$  times the original volume, or in this case, it doubled.

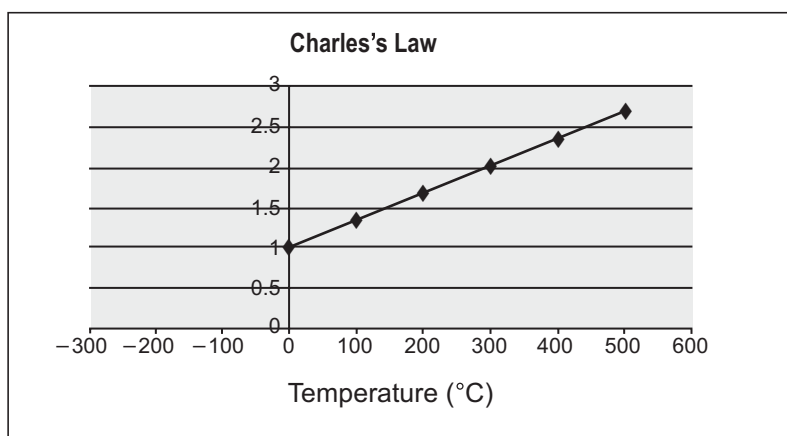

**SKILLS AND ATTITUDES OUTCOMES**

**C11-0-S7:** Interpret patterns and trends in data, and infer and explain relationships.

**C11-0-S8:** Evaluate data and data-collection methods for accuracy and precision.

Include: discrepancies in data, sources of error, percent error

**C11-0-S9:** Draw a conclusion based on the analysis and interpretation of data.

Include: cause-and-effect relationships, alternative explanations, supporting or rejecting a hypothesis or prediction

**C11-0-R1:** Synthesize information obtained from a variety of sources.

Include: print and electronic sources, specialists, other resource people

**C11-0-R5:** Communicate information in a variety of forms appropriate to the audience, purpose, and context.

It was not until 61 years later that William Thomson (later elevated to the peerage as Lord Kelvin) recognized the significance of the 273 and created the Kelvin scale where  $-273^{\circ}\text{C}$  is the lowest temperature possible, or absolute zero. Based on this, the  $x$ -intercept on a graph of volume versus temperature for any gas would always be  $-273^{\circ}\text{C}$ . Students could extrapolate the Charles's Law graph and determine a good value for 0 K—that is, the temperature at which the volume becomes zero. For a full-size graph, see Appendix 2.6: Charles's Law.

Lord Kelvin (1824–1907) further reasoned that at this temperature all molecular motion would cease, the kinetic energy would be zero, and the volume of a gas, hypothetically, would also be zero. The actual 0 K is equal to  $-273.15^{\circ}\text{C}$  (taken to five significant figures). The advantage of this scale is that there are no negative numbers. We now solve Charles's Law by converting to kelvins and use the same ratio argument we used in Boyle's Law problems. (**Note:** For most student problem sets, the use of 273 K is sufficient.)

$$\text{kelvin} = \text{centigrade} + 273.15 \quad \text{or} \quad \text{K} = ^{\circ}\text{C} + 273.15$$

*Example:*

	<b>Kelvin Scale</b>	<b>Celsius Scale</b>
Absolute zero	0 K	$-273.15^{\circ}\text{C}$
Freezing point of water	273.15 K	$0^{\circ}\text{C}$
Boiling point of water	373.15 K	$100^{\circ}\text{C}$

**Sample Problems****Problem 1:**

If the temperature of 6.00 L of a gas at  $25.0^{\circ}\text{C}$  is increased to  $227^{\circ}\text{C}$ , determine the volume at the new temperature.

**SPECIFIC LEARNING OUTCOME**

**C11-2-06:** Experiment to develop the relationship between the volume and temperature of a gas using visual, numerical, and graphical representations.

Include: historical contributions of Jacques Charles, the determination of absolute zero, the Kelvin temperature scale

(continued)

---

*Solution:*

First change the temperatures to kelvins.

$$25.0^{\circ}\text{C} + 273 = 298 \text{ K}$$

$$227^{\circ}\text{C} + 273 = 500 \text{ K}$$

There are only two possible ratios for the units to cancel:

$$\text{a) } \frac{298 \text{ K}}{500 \text{ K}} \quad \text{or} \quad \text{b) } \frac{500 \text{ K}}{298 \text{ K}}$$

From Charles's Law we know that  $V \propto T(\text{K})$ . So the volume must get larger since the temperature is increasing. Multiplying the second ratio (b) by the original volumes of 6.00 L would make the values increase, and so (b) is the ratio we need to use.

$$6.00 \text{ L} \times \frac{500 \cancel{\text{K}}}{298 \cancel{\text{K}}} = 10.1 \text{ L}$$

**Problem 2:**

If the volume of a gas at  $-73.0^{\circ}\text{C}$  is doubled to 48.0 L, calculate the final temperature in Celsius.

*Solution:*

First change the initial temperature to kelvin.

$$-73.0^{\circ}\text{C} + 273 = 200 \text{ K}$$

The possible ratios to solve the problem according to Charles's Law are:

$$\text{a) } \frac{48.0 \text{ L}}{24.0 \text{ L}} \quad \text{or} \quad \text{b) } \frac{24.0 \text{ L}}{48.0 \text{ L}}$$

Since the volume doubled, the temperature must have increased, and the ratio that increases the temperature values when multiplied by the ratio is (a). Therefore:

$$200 \text{ K} \times \frac{48.0 \cancel{\text{L}}}{24.0 \cancel{\text{L}}} = 400 \text{ K}$$

$$400 \text{ K} - 273 = 127^{\circ}\text{C}$$

**SKILLS AND ATTITUDES OUTCOMES**

**C11-0-S7:** Interpret patterns and trends in data, and infer and explain relationships.

**C11-0-S8:** Evaluate data and data-collection methods for accuracy and precision.

Include: discrepancies in data, sources of error, percent error

**C11-0-S9:** Draw a conclusion based on the analysis and interpretation of data.

Include: cause-and-effect relationships, alternative explanations, supporting or rejecting a hypothesis or prediction

**C11-0-R1:** Synthesize information obtained from a variety of sources.

Include: print and electronic sources, specialists, other resource people

**C11-0-R5:** Communicate information in a variety of forms appropriate to the audience, purpose, and context.

**SUGGESTIONS FOR ASSESSMENT****Laboratory Activities**

The activities outlined for learning outcome C11-2-06 could be assessed either as formal lab reports using the Laboratory Report Format (see *SYSTH* 14.12) or by using questions and answers from the data collected from the various activities. Labs can be adapted from existing materials for CBLs, probes, or computers. A microscale lab is also available. (See Learning Resources Links for references.)

**Research**

The stories behind the lives and research of scientists are interesting to read. Have students research the Internet (e.g., Google) for information on the following prominent scientists:

- Guillaume Amontons
- Jacques Alexandre César Charles
- Joseph Louis Gay-Lussac
- William Thomson (Lord Kelvin)

The information gathered could be presented and assessed by a number of methods, including

- letters written to another scientist claiming credit for a discovery
- debates between scientists claiming credit
- posters or pamphlets
- short *PowerPoint* presentations
- written reports

**Paper-and-Pencil Task**

The texts cited in the Learning Resources Links provide samples of problems with Charles's Law relationships.

**Did You Know?**

Guillaume Amontons developed the air thermometer. It relied on an increase in volume of a gas with temperature, rather than the increase in volume of a liquid.



### SPECIFIC LEARNING OUTCOME

**C11-2-06:** Experiment to develop the relationship between the volume and temperature of a gas using visual, numerical, and graphical representations.

Include: historical contributions of Jacques Charles, the determination of absolute zero, the Kelvin temperature scale

(continued)

---

### LEARNING RESOURCES LINKS

---



*Chemistry* (Chang 172)

*Chemistry* (Zumdahl and Zumdahl 195)

*Chemistry: The Central Science* (Brown, et al. 372)

*Chemistry: Concepts and Applications* (Phillips, Strozak, and Wistrom 391)

*Chemistry: The Molecular Nature of Matter and Change* (Silberberg 181)

*Chemistry with Calculators* (Holmquist and Volz) – Available from Vernier:  
<<http://www.vernier.com/chemistry/>>

*Glencoe Chemistry: Matter and Change* (Dingrando, et al. 423)

*Glencoe Chemistry: Matter and Change: CBL Laboratory Manual – Teacher Edition*  
(LAB 5: Gay-Lussac's Law, 17)

*Introductory Chemistry: A Foundation* (Zumdahl 367)

*McGraw-Hill Ryerson Chemistry 11, Ontario Edition* (Mustoe, et al. 436, 440)

*Microscale Chemistry Laboratory Manual* (Slater and Rayner-Canham 9)

*Nelson Chemistry 11, Ontario Edition* (Jenkins, et al. 429)

*Nelson Chemistry 12: College Preparation, Ontario Edition* (Davies, et al. 335)

PASCO Scientific. Physics Experiment Kits. Ideal Gas Law Experiment  
#9954 – Available from PASCO: <<http://www.pasco.com/products/groups/55-372-2.html>>

*Prentice Hall Chemistry: Connections to Our Changing World* (LeMay, et al. 435)

**SKILLS AND ATTITUDES OUTCOMES**

**C11-0-S7:** Interpret patterns and trends in data, and infer and explain relationships.

**C11-0-S8:** Evaluate data and data-collection methods for accuracy and precision.

Include: discrepancies in data, sources of error, percent error

**C11-0-S9:** Draw a conclusion based on the analysis and interpretation of data.

Include: cause-and-effect relationships, alternative explanations, supporting or rejecting a hypothesis or prediction

**C11-0-R1:** Synthesize information obtained from a variety of sources.

Include: print and electronic sources, specialists, other resource people

**C11-0-R5:** Communicate information in a variety of forms appropriate to the audience, purpose, and context.

---

**NOTES**

**SPECIFIC LEARNING OUTCOME**

**C11-2-07:** Experiment to develop the relationship between the pressure and temperature of a gas using visual, numerical, and graphical representations.

Include: historical contributions of Joseph Louis Gay-Lussac

(1.0 hour)

SLO: C11-2-07

**SUGGESTIONS FOR INSTRUCTION**
**Entry-Level Knowledge**

No prior entry-level knowledge is expected, other than what was indicated for previous learning outcomes in Topic 2: Gases and the Atmosphere.

**Assessing Prior Knowledge**

Check for understanding of prior knowledge and review as necessary. Prior knowledge can be reviewed and/or assessed by using any of the KWL strategies (e.g., Concept Map, Knowledge Chart, Think-Pair-Share—see *SYSTH*, Chapter 9).

If students have not yet visualized the relationship between pressure, volume, and temperature, show them the following visual. Imagine that three holes (labelled P, T, and V) are made in a length of wood such as a wooden ruler, as shown below.

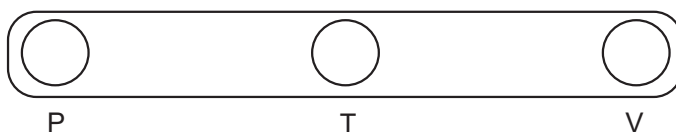

- If P is constant, and held in a fixed position, as T moves down so does V (i.e.,  $T \propto V$ ).
- If T is constant, and held in a fixed position, the stick acts like a see-saw and shows the inverse relationship for Boyle,  $P \propto 1/V$ .
- Similarly, if V is constant,  $P \propto T$ , and so on.

**General Learning Outcome Connections**

- GLO A2:** Recognize that scientific knowledge is based on evidence, models, and explanations, and evolves as new evidence appears and new conceptualizations develop.
- GLO A4:** Identify and appreciate contributions made by women and men from many societies and cultural backgrounds that have increased our understanding of the world and brought about technological innovations.
- GLO C4:** Demonstrate appropriate critical thinking and decision-making skills when choosing a course of action based on scientific and technological information.
- GLO C7:** Work cooperatively and value the ideas and contributions of others while carrying out scientific and technological activities.
- GLO C8:** Evaluate, from a scientific perspective, information and ideas encountered during investigations and in daily life.

**SKILLS AND ATTITUDES OUTCOMES**

**C11-0-S5:** Collect, record, organize, and display data using an appropriate format.

*Examples: labelled diagrams, graphs, multimedia applications, software integration, probeware...*

**C11-0-S7:** Interpret patterns and trends in data, and infer and explain relationships.

**C11-0-S9:** Draw a conclusion based on the analysis and interpretation of data.

Include: cause-and-effect relationships, alternative explanations, supporting or rejecting a hypothesis or prediction

---

**TEACHER NOTES**

The presentation of the gas laws is generally *sequential* and *developmental* in its approach. Therefore, the next gas law addressed in this topic follows from the work done by Jacques Charles and Robert Boyle. Recall that in the treatment of specific learning outcome C11-1-02, the Kinetic Molecular Theory was used as a model to explain the properties of gases. An increase in the temperature of a gas increases the kinetic energy of the gas, and thus the frequency of collisions among gaseous particulates. It is not surprising, then, to expect that an increase in temperature would cause an increase in the pressure of a gas at constant volume due to kinetics and energy involved. Joseph Gay-Lussac explored this relationship and found that a direct relationship exists between the kelvin temperature and the pressure of the gas (i.e.,  $P \propto T$  [K]).

**Activities/Demonstrations**

1. It is recommended that the relationship between the temperature and pressure of a gas be developed experimentally or by a demonstration in which students collect data and draw their own conclusions.
2. If probeware is available, use lab activities designed to determine the relationship between pressure and temperature.
3. A piece of equipment designed specifically to demonstrate the relationship between pressure and temperature can be purchased from most science supply locations. It consists of a metal bulb connected to a pressure gauge and a valve through which air can be added. If the equipment is used correctly, students can achieve a very good experimental value for Gay-Lussac's relationship.
4. If a eudiometer, two-thirds filled with water, is inverted in a 1 L glass graduated cylinder filled with water, the volume of air in the tube can be seen to change as the hydrostatic head changes by lowering and raising the tube in the cylinder. This demonstration can also be quantitative by measuring the volume and calculating the water pressure. The pressure of the air in the tube would be the same as atmospheric pressure when the water levels are aligned opposite each other. **Note:** The partial pressure contribution from the water vapour could be left out of the discussion to make the calculations less complex. Including the partial pressure contribution due to water vapour would be considered enrichment. Dalton's Law of partial pressures is not included in Grade 11 Chemistry, but can certainly be included where circumstances and the interests of students warrant its treatment.



**SPECIFIC LEARNING OUTCOME**

**C11-2-07:** Experiment to develop the relationship between the pressure and temperature of a gas using visual, numerical, and graphical representations.

Include: historical contributions of Joseph Louis Gay-Lussac

(continued)

5. Another method of illustrating the relationship between pressure and temperature is to use a scuba tank (with half its maximum pressure) connected to a regulator and pressure gauge. Measure the initial pressure at below room temperature (as in a cool area of the school), and then measure the pressure as the temperature slowly rises to above room temperature (as in a hot water bath). Students graph the results to obtain Gay-Lussac's discovery of the relationship between pressure and temperature. (See Teacher Notes.)

**TEACHER NOTES**

Have someone from a local diving supply shop, or a responsible local diver, come into the school to assist with the demonstration using a scuba tank. North American pressure gauges will read pressure in pounds per square inch (psi). Teachers or students can easily convert this to kilopascals (kPa) or atmospheres (atm).

$$1500 \text{ psi} \times \frac{6.89476 \text{ kPa}}{\text{psi}} = \text{kPa}$$

$$15000 \text{ psi} \times \frac{0.0680460 \text{ atm}}{\text{psi}} = \text{atm}$$

**Safety Precautions**

- Even though safeguards against excessive pressure are built into the scuba tank, it is recommended that teachers use a tank that allows only half the maximum pressure. A "burst" plug of lead is built into the tank valve that will deform and allow the gas from the tank to escape if the pressure in the tank exceeds a set maximum amount.
- Each certified tank must be hydrostatically tested (required every five years) to withstand five-thirds (5/3) of the maximum pressure. School administration should be notified well in advance of this demonstration being done.

**SKILLS AND ATTITUDES OUTCOMES**

**C11-0-S5:** Collect, record, organize, and display data using an appropriate format.

*Examples: labelled diagrams, graphs, multimedia applications, software integration, probeware...*

**C11-0-S7:** Interpret patterns and trends in data, and infer and explain relationships.

**C11-0-S9:** Draw a conclusion based on the analysis and interpretation of data.

Include: cause-and-effect relationships, alternative explanations, supporting or rejecting a hypothesis or prediction

**SUGGESTIONS FOR ASSESSMENT****Sample Problems**

Most chemistry textbooks provide problems based on  $P \propto T$  (K). Try to avoid having students solve problems using the gas law formulas. Have students use the ratio method whenever possible.

**Problem 1:**

If a sample of gas is found to have a volume of 12.0 L at 0.0°C, calculate the new pressure at 128°C if the volume is constant.

*Solution:*

Initial values: 12.0 L    0.0°C

Final values:        \_\_\_\_\_    128°C

0.0°C = 273 K    and    128°C = 401 K

Two possible ratios would produce the correct unit in the answer.

$$\text{a) } \frac{273 \text{ K}}{401 \text{ K}} \quad \text{or} \quad \text{b) } \frac{401 \text{ K}}{273 \text{ K}}$$

According to the Kinetic Molecular Theory, an increase in the temperature of a gas increases the kinetic energy of the gas and thus the frequency of collisions. Therefore, we can expect that an increase in temperature should cause an increase in the pressure of a gas at constant volume. If  $P \propto T$  (K), then the ratio (b) should cause an increase in the volume to get the correct answer to the problem. Therefore:

$$101.3 \text{ kPa} \times \frac{401 \text{ K}}{273 \text{ K}} = 149 \text{ kPa}$$

**Laboratory Reports**

Students will either have done the lab activity or seen a demonstration of Gay-Lussac's Law. Assessment could include a formal lab report using the Laboratory Report Format (see *SYSTH* 14.12) or questions and answers about the activity or the results.



### SPECIFIC LEARNING OUTCOME

**C11-2-07:** Experiment to develop the relationship between the pressure and temperature of a gas using visual, numerical, and graphical representations.

Include: historical contributions of Joseph Louis Gay-Lussac

(continued)

### Rubrics/Checklists

See Appendix 10 for a variety of rubrics and checklists that can be used for self-assessment, peer assessment, and teacher assessment.

### Paper-and-Pencil Tasks

Provide students with an opportunity to explain and differentiate between each gas law before going on to the combined laws. This can be done effectively using a Concept Relationship frame (see *SYSTH* 11.21).

### Journal Writing

Students may want to reflect on the results of the activities connected to learning outcome C11-2-07 with, for instance, a description of procedures involved in handling compressed gases in cylinders.

### LEARNING RESOURCES LINKS



*Chemistry* (Chang 172)

*Chemistry* (Zumdahl and Zumdahl 195)

*Chemistry: The Central Science* (Brown, *et al.* 372)

*Chemistry: Concepts and Applications* (Phillips, Strozak, and Wistrom 391)

*Chemistry: The Molecular Nature of Matter and Change* (Silberberg 181)

*Chemistry with Calculators* (Holmquist and Volz, Pressure-Temperature Relationship in Gases) – Available from Vernier:  
<<http://www.vernier.com/chemistry/>>

*Chemistry with Computers* (Holmquist and Volz) – Available from Vernier:  
<<http://www.vernier.com/chemistry/>>

*Glencoe Chemistry: Matter and Change* (Dingrando, *et al.* 423)

*Glencoe Chemistry: Matter and Change: CBL Laboratory Manual – Teacher Edition* (LAB 5: Gay-Lussac's Law, 17)

*McGraw-Hill Ryerson Chemistry 11, Ontario Edition* (Mustoe, *et al.* 440)

*Nelson Chemistry 11, Ontario Edition* (Jenkins, *et al.* 429)

*Prentice Hall Chemistry: Connections to Our Changing World* (LeMay, *et al.* 435)

**SKILLS AND ATTITUDES OUTCOMES**

**C11-0-S5:** Collect, record, organize, and display data using an appropriate format.

*Examples: labelled diagrams, graphs, multimedia applications, software integration, probeware...*

**C11-0-S7:** Interpret patterns and trends in data, and infer and explain relationships.

**C11-0-S9:** Draw a conclusion based on the analysis and interpretation of data.

Include: cause-and-effect relationships, alternative explanations, supporting or rejecting a hypothesis or prediction

---

**NOTES**



**SPECIFIC LEARNING OUTCOME**

**C11-2-08:** Solve quantitative problems involving the relationships among the pressure, temperature, and volume of a gas using dimensional analysis.

Include: symbolic relationships

(1.0 hour)

SLO: C11-2-08

**SUGGESTIONS FOR INSTRUCTION**

**Entry-Level Knowledge**

At this point, students should be able to solve gas law problems using the ratio method and dimensional analysis.

**TEACHER NOTES**

The ratio method for solving problems can now be applied to more than one variable where several gas laws are used.

So far, students know:

$$V \propto 1/P, \quad V \propto T (K), \quad P \propto T (K)$$

**Sample Problems**

**Problem 1:**

If a gas occupies a volume of 25.0 L at 25.0°C and 1.25 atm, *calculate the volume at 128°C and 0.750 atm.*

25.0 L at 298 K and 1.25 atm

\_\_\_ L at 401 K and 0.75 atm

*Solution:*

Two sets of ratios are possible to give the correct units in the answer.

For V and P:

$$\text{a) } \frac{1.25 \text{ atm}}{0.750 \text{ atm}} \quad \text{or} \quad \text{b) } \frac{0.750 \text{ atm}}{1.25 \text{ atm}}$$

For an inverse proportion, as P decreases, V increases; therefore, ratio (a) should be used.

**General Learning Outcome Connections**

**GLO C3:** Demonstrate appropriate problem-solving skills when seeking solutions to technological challenge.

**GLO D3:** Understand the properties and structures of matter, as well as various common manifestations and applications of the actions and interactions of matter.

**SKILLS AND ATTITUDES OUTCOMES**

**C11-0-U1:** Use appropriate strategies and skills to develop an understanding of chemical concepts.

*Examples: analogies, concept frames, concept maps, manipulatives, particulate representations, role-plays, simulations, sort-and-predict frames, word cycles...*

**C11-0-U2:** Demonstrate an understanding of chemical concepts.

*Examples: use accurate scientific vocabulary, explain concepts to others, compare and contrast concepts, apply knowledge to new situations and/or contexts, create analogies, use manipulatives...*

For V and T:

$$\text{a) } \frac{401 \text{ K}}{298 \text{ K}} \quad \text{or} \quad \text{b) } \frac{298 \text{ K}}{401 \text{ K}}$$

For a direct proportion, as T increases, V increases; therefore, ratio (a) should be used.

$$25.0 \text{ L} \times \frac{1.25 \text{ atm}}{0.750 \text{ atm}} \times \frac{401 \text{ K}}{298 \text{ K}} = 56.1 \text{ L}$$

The atm and K units cancel, leaving L for the answer.

**Problem 2:**

If a gas has a volume of 125 L at 325 kPa and 58.0°C, calculate the temperature in Celsius to produce a volume of 22.4 L at 101.3 kPa.

*Solution:*

58.0°C becomes 331 K

125 L at 325 kPa and 331 K

22.4 L at 101.3 kPa and \_\_\_ K

331 K x volume ratio x pressure ratio = answer

Since  $V \propto T$  (K), if V decreases, then T should decrease, and the ratio would be:

$$331 \text{ K} \times \frac{22.4 \text{ L}}{125 \text{ L}}$$

Since  $P \propto T$  (K), if P decreases, then T decreases, and the ratio would be:

$$331 \text{ K} \times \frac{22.4 \text{ L}}{125 \text{ L}} \times \frac{101.3 \text{ kPa}}{325 \text{ kPa}} = 18.5 \text{ K or } -254^\circ\text{C}$$

**SPECIFIC LEARNING OUTCOME**

**C11-2-08:** Solve quantitative problems involving the relationships among the pressure, temperature, and volume of a gas using dimensional analysis.

Include: symbolic relationships

(continued)

**Solving Problems by Symbolic Relationships**

- Boyle's Law:  $P_1V_1 = P_2V_2$
- Charles's Law:  $V_1/T_1 = V_2/T_2$
- Gay-Lussac's Law:  $P_1/T_1 = P_2/T_2$

Pressure and volume are directly related to temperature, whereas P and V are inversely related to each other. Therefore, we can derive the "combined gas law":

$$P_1V_1/T_1 = P_2V_2/T_2$$

**Solving Problems Numerically**

Using the equation  $P_1V_1/T_1 = P_2V_2/T_2$ , solve problems involving pressure, volume, and temperature.

**TEACHER NOTES**

The following is a method for explaining the combined relationship:

$$(P_1V_1) \times (V_1/T_1) \times (P_1/T_1) = (P_2V_2) \times (V_2/T_2) \times (P_2/T_2)$$

Multiplying each part:

$$\frac{P_1^2V_1^2}{T_1^2} = \frac{P_2^2V_2^2}{T_2^2}$$

Taking the square root of both sides:

$$\sqrt{\frac{P_1^2V_1^2}{T_1^2}} = \sqrt{\frac{P_2^2V_2^2}{T_2^2}}$$

We get:

$$\frac{P_1V_1}{T_1} = \frac{P_2V_2}{T_2}$$

There are two schools of thought with regard to the solution of problems involving literal equations. One method is to solve the literal equation for the required variable first before substituting in values, while the other method is to substitute values into the equation first and then solve for the required value.

**SKILLS AND ATTITUDES OUTCOMES**

**C11-0-U1:** Use appropriate strategies and skills to develop an understanding of chemical concepts.

*Examples: analogies, concept frames, concept maps, manipulatives, particulate representations, role-plays, simulations, sort-and-predict frames, word cycles...*

**C11-0-U2:** Demonstrate an understanding of chemical concepts.

*Examples: use accurate scientific vocabulary, explain concepts to others, compare and contrast concepts, apply knowledge to new situations and/or contexts, create analogies, use manipulatives...*

**Sample Problems (continued)****Problem 3:**

Salvage divers often use lift bags to lift objects to the surface. Divers are required to make a pre-dive calculation of the forces involved, to ensure the safety of the divers during the recovery. A lift bag contains 145 L of air at the bottom of a lake, at a temperature of 5.20°C and a pressure of 6.00 atm. As the bag is released, it ascends to the surface, where the pressure is 1.00 atm and 16.0°C. Calculate what volume the gas would occupy at the surface of the lake. If the maximum volume of the lift bag is 750 L, will the bag burst at the surface?

*Solution:*

145 L at 278.2°C and 6.00 atm

V<sub>2</sub> at 289°C and 1.00 atm

Solving for V<sub>2</sub> first:

$$V_2 = \frac{P_1 V_1 T_2}{P_2 T_1}$$

$$V_2 = 904 \text{ L}$$

The new volume of 904 L exceeds the limit of the lift bag, which will burst, causing the object to drop to the bottom of the lake again.

**SUGGESTIONS FOR ASSESSMENT**

Assess students' achievement of learning outcome C11-2-08 using problems obtained from chemistry textbooks or from teacher reference material. An obvious caution is for the teacher to solve the problems before giving them to students to make sure they are at the appropriate level of difficulty and can be solved using the information presented in this document.

Many publishers provide CDs that contain banks of test questions. There are usually a variety of types of questions for each major topic: multiple choice, matching, true and false, short answer, long answer, essay questions, and so on. The test-maker program will often allow the teacher to: access an existing test bank, create a test with an answer key, create Internet-published tests and study guides, and prepare tests that can be displayed on a local school network system.





**SPECIFIC LEARNING OUTCOME**

**C11-2-08:** Solve quantitative problems involving the relationships among the pressure, temperature, and volume of a gas using dimensional analysis.

Include: symbolic relationships

(continued)

---

**LEARNING RESOURCES LINKS**

---



*Chemistry: Concepts and Applications* (Phillips, Strozak, and Wistrom 394)

*Glencoe Chemistry: Matter and Change* (Dingrando, et al. 428)

*McGraw-Hill Ryerson Chemistry 11, Ontario Edition* (Mustoe, et al. 452)

*Nelson Chemistry 11, Ontario Edition* (Jenkins, et al. 436)

**SKILLS AND ATTITUDES OUTCOMES**

**C11-0-U1:** Use appropriate strategies and skills to develop an understanding of chemical concepts.

*Examples: analogies, concept frames, concept maps, manipulatives, particulate representations, role-plays, simulations, sort-and-predict frames, word cycles...*

**C11-0-U2:** Demonstrate an understanding of chemical concepts.

*Examples: use accurate scientific vocabulary, explain concepts to others, compare and contrast concepts, apply knowledge to new situations and/or contexts, create analogies, use manipulatives...*

---

**NOTES**



## SPECIFIC LEARNING OUTCOME

**C11-2-09:** Identify various industrial, environmental, and recreational applications of gases.

*Examples: self-contained underwater breathing apparatus (scuba), anaesthetics, air bags, acetylene welding, propane appliances, hyperbaric chambers...*

(2.0 hours)

SLO: C11-2-09

## SUGGESTIONS FOR INSTRUCTION

## Entry-Level Knowledge

No entry-level knowledge is expected.

## TEACHER NOTES

The following examples provide an introduction to what could be considered in achieving specific learning outcome C11-2-09. Teachers will likely select examples that relate to student and teacher interests and experiences. Supplement this material with additional research using a variety of resources (e.g., the Internet, texts, encyclopedias, journals, local experts).

- **Acetylene welding or oxy-fuel gas welding:** a group of welding processes that produce coalescence by heating materials with an oxygen-fuel gas flame or flames. There are four distinct processes within this group:
  - oxyacetylene welding
  - oxyhydrogen welding
  - air acetylene welding
  - pressure gas welding
- **Air bags:** a supplementary restraint system found in vehicles. An air bag slows a passenger's speed to zero with generally little or no damage. In the air bag's inflation system, sodium azide,  $\text{NaN}_3$ , reacts with potassium nitrate,  $\text{KNO}_3$ , to produce a rapid blast of nitrogen gas.

## General Learning Outcome Connections

- GLO B1:** Describe scientific and technological developments—past and present—and appreciate their impact on individuals, societies, and the environment, both locally and globally.
- GLO B2:** Recognize that scientific and technological endeavours have been and continue to be influenced by human needs and the societal context of the time.
- GLO B3:** Identify the factors that affect health, and explain the relationships among personal habits, lifestyle choices, and human health, both individual and social.
- GLO B4:** Demonstrate knowledge of and personal consideration for a range of possible science- and technology-related interests, hobbies, and careers.
- GLO C6:** Employ effective communication skills and use information technology to gather and share scientific and technological ideas and data.

## SKILLS AND ATTITUDES OUTCOMES

- C11-0-R1:** Synthesize information obtained from a variety of sources.  
Include: print and electronic sources, specialists, other resource people
- C11-0-R3:** Quote from or refer to sources as required and reference information sources according to an accepted practice.
- C11-0-R5:** Communicate information in a variety of forms appropriate to the audience, purpose, and context.
- C11-0-C1:** Collaborate with others to achieve group goals and responsibilities.

- **Airships:** powered balloons that can be steered. At one time, airships or dirigibles (like the famous Hindenburg) were filled with flammable hydrogen gas. Today such balloons or “blimps” are filled with hydrogen gas that is inert and safer but less buoyant than helium due to its larger atomic mass. Helium is also used in weather balloons. These balloons differ greatly from the hot-air balloons used for recreational purposes.
- **Anaesthetics:** the use of drugs (in this case inhalation anaesthetics) to reduce pain.
- **Hyperbaric chambers:** strong-walled metal chambers in which atmospheric pressure can be adjusted for research into therapeutic treatment or human environment extremes. Hyperbaric oxygen chambers have been used since the 1940s. They were originally used by the navy to treat divers who were suffering from decompression sickness commonly known as *the bends* (nitrogen narcosis). The person who required treatment was placed in the chamber and the pressure inside was increased to many atmospheres that would equilibrate with what the ambient pressures were at depth. This re-compressed (i.e., rendered soluble) the micro-bubbles of nitrogen gas in the blood and tissues in order to remove or reduce the symptoms of the illness. Even today, many treatments are often necessary, depending on the severity of exposure to excess pressure.

Two “baric” chambers are located in Winnipeg. Both chambers are associated with the Canadian Forces School of Survival and Aeromedical Training (CFSSAT) at Canadian Forces Base (CFB) Westwin. One chamber is *hyperbaric* and the other is *hypobaric*.

- The *hyperbaric* chamber is used to treat medical conditions of barotrauma.
- The *hypobaric* chamber is used to train pilots and air crew personnel with the symptoms of hypoxia. The chamber simulates going from ground level to an altitude of approximately 10,000 m.



Information on the CFB Westwin pressure chambers is available online at: National Defence. Canadian Forces School of Survival and Aeromedical Training (CFSSAT): <[http://www.airforce.forces.ca/17wing/squadron/cfssat\\_e.asp](http://www.airforce.forces.ca/17wing/squadron/cfssat_e.asp)>.

Today, hyperbaric chambers are still used to treat decompression sickness but they are now also used to treat other medical conditions, such as cancer and carbon monoxide poisoning. However, the jury is still out as to how successful these treatments have been. In some cases, athletes have been placed in chambers owned by athletic clubs, reportedly to improve the recovery of injuries by oxygenation of the blood.



**SPECIFIC LEARNING OUTCOME**

**C11-2-09:** Identify various industrial, environmental, and recreational applications of gases.

*Examples: self-contained underwater breathing apparatus (scuba), anaesthetics, air bags, acetylene welding, propane appliances, hyperbaric chambers...*

(continued)

- **Propane appliances:** appliances using propane as a fuel source. Propane often serves as a fuel for home heating systems. It is also used for a variety of applications, including cooking, clothes drying, pool/sauna heating, fireplaces, and grilling.

The propane refrigerator found in many recreation vehicles is an application of propane in an appliance. These refrigerators have no moving parts and use heat, in the form of burning propane, to produce the cold inside the refrigerator.

The cycle works like this:

1. Heat is applied to the generator. The heat comes from burning propane, kerosene, or some other combustible fuel.
  2. In the generator is a solution of ammonia and water. The heat raises the temperature of the solution to the boiling point of the ammonia.
  3. The boiling solution flows to the separator. In the separator, the water separates from the ammonia gas.
  4. The ammonia gas flows upward to the condenser. The condenser is composed of metal coils and fins that allow the ammonia gas to dissipate its heat and condense into a liquid.
  5. The liquid ammonia makes its way to the evaporator, where it mixes with hydrogen gas and evaporates, producing cold temperatures inside the refrigerator.
  6. The ammonia and hydrogen gases flow to the absorber. Here, the water that has collected in the separator is mixed with the ammonia and hydrogen gases.
  7. The ammonia forms a solution with the water and releases the hydrogen gas, which flows back to the evaporator. The ammonia-and-water solution flows toward the generator to repeat the cycle.
- **Self-contained underwater breathing apparatus (scuba):** an apparatus that divers use to provide air or other breathable gases at ambient pressure while they are submerged.

All three gas laws have an effect on underwater divers who must take into consideration all their combined effects when planning a dive. The modern regulator provides air on demand at ambient pressure. This means that at 99 ft. (30 m) or 4 atm, a regulator will adjust the pressure from the cylinder to 4.0 atm. The danger for a diver on ascent is that the gases within the body expand, and if adequate venting is not permitted, air bubbles can be forced into the tissues and bloodstream, with life-threatening consequences.

**SKILLS AND ATTITUDES OUTCOMES**

**C11-0-R1:** Synthesize information obtained from a variety of sources.

Include: print and electronic sources, specialists, other resource people

**C11-0-R3:** Quote from or refer to sources as required and reference information sources according to an accepted practice.

**C11-0-R5:** Communicate information in a variety of forms appropriate to the audience, purpose, and context.

**C11-0-C1:** Collaborate with others to achieve group goals and responsibilities.

---

The modern diver also wears a buoyancy-compensating device (BCD). This device holds the compressed air tank in place and controls buoyancy. The addition of too much air can cause a diver to accelerate toward the surface as the air inside the BCD expands with the reduced pressure. If the dissolved gas in the bloodstream cannot escape quickly enough, physical damage may result for the diver. Too little air in the BCD or too much weight on the weight belt can cause a descent that is too fast for the body to adjust safely, which again may cause injury.

**SUGGESTIONS FOR ASSESSMENT**

---

**Rubrics/Checklists**

See Appendix 10 for a variety of rubrics and checklists that can be used for self-assessment, peer assessment, and teacher assessment.

**Research Reports**

Have students research and report on various industrial, environmental, and recreational applications of gases (see Appendix 2.8: Applications of Gases in Our Lives). Some groups could present findings at this point, while others could report on a different topic at another time (e.g., in Topic 3: Chemical Reactions).

The information collected could be presented as

- written reports
- oral presentations
- bulletin board displays
- multimedia presentations

**Visual Displays**

Students could present the material they have collected using

- posters
- pamphlets
- bulletin boards
- models

Each presentation style could be assessed using an appropriate rubric created with students prior to the assignment. Samples of presentation rubrics are provided in Appendix 10 of this document.



### SPECIFIC LEARNING OUTCOME

**C11-2-09:** Identify various industrial, environmental, and recreational applications of gases.

*Examples: self-contained underwater breathing apparatus (scuba), anaesthetics, air bags, acetylene welding, propane appliances, hyperbaric chambers...*

(continued)

---

### Journal Writing

There are many uses of gas in our lives. Students may wish to reflect on how our lives would be different if industrial gases were not present.

### Topic-Review Activity

An activity game has been designed to review the material in Topic 2: Gases and the Atmosphere. For details, see Appendix 2.9: Review Game. Teachers can create their own set of questions to relate more specifically to their emphases, presentations, findings, and so on.

### LEARNING RESOURCES LINKS

---



*Chemistry* (Chang 184)

*Chemistry* (Zumdahl and Zumdahl 210)

*Chemistry: The Central Science* (Brown, *et al.* 381, 382)

*Chemistry: Concepts and Applications* (Phillips, Strozak, and Wistrom 387, 390, 417)

*Glencoe Chemistry: Matter and Change* (Dingrando, *et al.* 180, 376, 446)

*McGraw-Hill Ryerson Chemistry 11, Ontario Edition* (Mustoe, *et al.* 450, 506)

*Nelson Chemistry 11, Ontario Edition* (Jenkins, *et al.* 416, 441, 442)

*Nelson Chemistry 12: College Preparation, Ontario Edition* (Davies, *et al.* 331)

*Prentice Hall Chemistry: Connections to Our Changing World* (LeMay, *et al.* 359, 432, 447)

**SKILLS AND ATTITUDES OUTCOMES**

**C11-0-R1:** Synthesize information obtained from a variety of sources.

Include: print and electronic sources, specialists, other resource people

**C11-0-R3:** Quote from or refer to sources as required and reference information sources according to an accepted practice.

**C11-0-R5:** Communicate information in a variety of forms appropriate to the audience, purpose, and context.

**C11-0-C1:** Collaborate with others to achieve group goals and responsibilities.

---

**NOTES**





# TOPIC 3: CHEMICAL REACTIONS

---





### Topic 3: Chemical Reactions

- C11-3-01** Determine average atomic mass using isotopes and their relative abundance.  
Include: atomic mass unit (amu)
- C11-3-02** Research the importance and applications of isotopes.  
*Examples: nuclear medicine, stable isotopes in climatology, dating techniques...*
- C11-3-03** Write formulas and names for polyatomic compounds using International Union of Pure and Applied Chemistry (IUPAC) nomenclature.
- C11-3-04** Calculate the mass of compounds in atomic mass units.
- C11-3-05** Write and classify balanced chemical equations from written descriptions of reactions.  
Include: polyatomic ions
- C11-3-06** Predict the products of chemical reactions, given the reactants and type of reaction.  
Include: polyatomic ions
- C11-3-07** Describe the concept of the mole and its importance to measurement in chemistry.
- C11-3-08** Calculate the molar mass of various substances.
- C11-3-09** Calculate the volume of a given mass of a gaseous substance from its density at a given temperature and pressure.  
Include: molar volume calculation
- C11-3-10** Solve problems requiring interconversions between moles, mass, volume, and number of particles.
- C11-3-11** Determine empirical and molecular formulas from percent composition or mass data.
- C11-3-12** Interpret a balanced equation in terms of moles, mass, and volumes of gases.
- C11-3-13** Solve stoichiometric problems involving moles, mass, and volume, given the reactants and products in a balanced chemical reaction.  
Include: heat of reaction problems
- C11-3-14** Identify the limiting reactant and calculate the mass of a product, given the reaction equation and reactant data.
- C11-3-15** Perform a lab involving mass-mass or mass-volume relations, identifying the limiting reactant and calculating the mole ratio.  
Include: theoretical yield, experimental yield
- C11-3-16** Discuss the importance of stoichiometry in industry and describe specific applications.  
*Examples: analytical chemistry, chemical engineering, industrial chemistry...*

**Suggested Time: 25.5 hours**





## SPECIFIC LEARNING OUTCOME

**C11-3-01:** Determine average atomic mass using isotopes and their relative abundance.

Include: atomic mass unit (amu)

(2.0 hours)

SLO: C11-3-01

## SUGGESTIONS FOR INSTRUCTION

**General Note to Teachers**

As Topic 3 is a long unit, teachers are strongly encouraged to divide it into two parts.

**Entry-Level Knowledge**

In Grade 9 Science (learning outcome S1-2-04), students learned about the basic atomic structure (protons, neutrons, and electrons), atomic number, and average atomic mass of elements. They should be able to use this information to draw Bohr models of various atoms. See *Senior 1 Science: A Foundation for Implementation* (Manitoba Education and Training, A28, A34-37).

**TEACHER NOTES**

Different variations of atoms of the same element occur in nature. These variations are called *isotopes*. The average mass of the isotopes for each element is a characteristic of that element.

*Isotopes* are atoms of the same element (same number of protons) with different numbers of neutrons. They have identical atomic numbers (number of protons) but different mass numbers (number of protons plus number of neutrons).

A = mass number

${}^A_Z X$  X = symbol

Z = atomic number

**General Learning Outcome Connections**

- GLO A4:** Identify and appreciate contributions made by women and men from many societies and cultural backgrounds that have increased our understanding of the world and brought about technological innovations.
- GLO B1:** Describe scientific and technological developments—past and present—and appreciate their impact on individuals, societies, and the environment, both locally and globally.
- GLO D3:** Understand the properties and structures of matter, as well as various common manifestations and applications of the actions and interactions of matter.
- GLO D5:** Understand the composition of the Earth's atmosphere, hydrosphere, and lithosphere, as well as the processes involved within and among them.
- GLO E3:** Recognize that characteristics of materials and systems can remain constant or change over time, and describe the conditions and processes involved.

**SKILLS AND ATTITUDES OUTCOMES**

**C11-0-U1:** Use appropriate strategies and skills to develop an understanding of chemical concepts.

*Examples: analogies, concept frames, concept maps, manipulatives, particulate representations, role-plays, simulations, sort-and-predict frames, word cycles...*

**C11-0-U2:** Demonstrate an understanding of chemical concepts.

*Examples: use accurate scientific vocabulary, explain concepts to others, compare and contrast concepts, apply knowledge to new situations and/or contexts, create analogies, use manipulatives...*

**C11-0-S7:** Interpret patterns and trends in data, and infer and explain relationships.

---

Isotopes are usually represented in several ways.

*Example:*

Sodium-24 or  $^{24}\text{Na}$

The atomic mass unit (often designated as u,  $\mu$ , or amu) is defined as 1/12th the mass of a carbon-12 (C-12) atom. The magnitude of the atomic mass unit is arbitrary. In fact, 1/24th the mass of a carbon atom or 1/10th the mass of the iron atom could have been selected just as easily. Three reasons for using 1/12th the mass of a C-12 isotope are:

- Carbon is a very common element.
- It results in nearly whole-number atomic masses for most other elements.
- The lightest element, hydrogen (H), has a mass of approximately 1 amu.

When the amu was first developed, the mass in grams of 1 amu was unknown; however, it has since been experimentally determined. The atomic mass unit is an extremely small unit of mass.

**Activity: Average Atomic Mass**

Illustrate how the average atomic masses of atoms are determined by their relative mass compared to C-12.

Students should use relative abundance data to calculate the average atomic mass of elements. Most elements have naturally occurring isotopes. The *CRC Handbook of Chemistry and Physics* will provide the relative abundance for each of them.

**Note:** When using data from the handbook, make sure that the percent abundance calculates to the actual atomic mass.

*Examples:*

One of the dietary sources of potassium is the banana: 93.1% of the potassium atoms are potassium-39 (20 neutrons), 6.88% are potassium-41, and only a trace are potassium-40.

Elemental boron is a combination of two naturally occurring isotopes: boron-10 has a relative abundance of 19.78% and boron-11 has a relative abundance of 80.22%.

**SPECIFIC LEARNING OUTCOME**

**C11-3-01:** Determine average atomic mass using isotopes and their relative abundance.

Include: atomic mass unit (amu)

(continued)

Sample:

Relative Abundance of Stable Magnesium (Mg) Isotopes		
Isotope	Relative Abundance (%)	Atomic Mass ( $\mu$ )
Mg-24	78.70	23.98504
Mg-25	10.13	24.98584
Mg-26	11.17	25.98259

For additional questions, see Appendix 3.1: Calculating Average Atomic Mass.

**Laboratory Activity**

Students could develop their understanding of relative abundances by completing a simulation lab activity in which the average mass of Canadian pennies is used to mirror how the average atomic mass is determined. For this activity, students would require archival data from the Royal Canadian Mint outlining the percent composition of iron, steel, zinc, copper, and other metals (such as Sn) found in alloys used to mint pennies. About every five years, these alloys change, due to fluctuations in world commodity prices for the native metals.

For a history of the composition of the penny, see the following website:



Northern Blue Publishing. Canadian History Business News. The Small Canadian Penny: <<http://northernblue.ca/cbushist/index.php?/archives/165-The-Small-Canadian-Penny.html>>

Another activity related to percent composition in Canadian currency can be downloaded from:

Magma Communications. Doug De La Matter. Experiments with Coins: <<http://www.magma.ca/~dougdel/ideas/coindemo.pdf>>

**Analogy**

The use of weighted averages to determine a student's mark involves the same process as determining the average atomic mass.

**SKILLS AND ATTITUDES OUTCOMES**

**C11-0-U1:** Use appropriate strategies and skills to develop an understanding of chemical concepts.

*Examples: analogies, concept frames, concept maps, manipulatives, particulate representations, role-plays, simulations, sort-and-predict frames, word cycles...*

**C11-0-U2:** Demonstrate an understanding of chemical concepts.

*Examples: use accurate scientific vocabulary, explain concepts to others, compare and contrast concepts, apply knowledge to new situations and/or contexts, create analogies, use manipulatives...*

**C11-0-S7:** Interpret patterns and trends in data, and infer and explain relationships.

**SUGGESTIONS FOR ASSESSMENT****Rubrics/Checklists**

See Appendix 10 for a variety of rubrics and checklists that can be used for self-assessment, peer assessment, and teacher assessment.

**Laboratory Activity**

The lab activity that models the relative abundances of isotopes using the historical composition of Canadian pennies could be assessed either as a formal lab report using the Laboratory Report Format (see *SYSTH 14.12*) or by using questions and answers from the data collected from the activity.

**Visual Display**

Introduce students to isotopes by having them draw the isotopes of hydrogen (H).

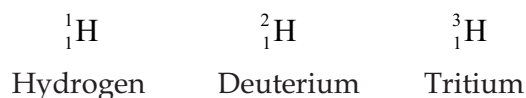

Students could present what they have learned using

- posters
- pamphlets
- bulletin board displays
- models

Each of these presentation styles could be assessed using an appropriate rubric created with students prior to the assignment. A sample presentation rubric is provided in Appendix 10 of this document.

**Paper-and-Pencil Tasks**

Students should calculate the average atomic mass of various elements based on relative abundance data. When using data from the *CRC Handbook of Chemistry and Physics*, make sure that the percent abundance calculates to the actual atomic mass.





**SPECIFIC LEARNING OUTCOME**

**C11-3-01:** Determine average atomic mass using isotopes and their relative abundance.

Include: atomic mass unit (amu)

(continued)

---

**LEARNING RESOURCES LINKS**



*Chemistry* (Chang 49)

*Chemistry: The Central Science* (Brown, et al. 44)

*Chemistry: Concepts and Applications* (Phillips, Strozak, and Wistrom 67)

*Chemistry: The Molecular Nature of Matter and Change* (Silberberg 52)

*Glencoe Chemistry: Matter and Change* (Dingrando, et al. 102)

*McGraw-Hill Ryerson Chemistry, Combined Atlantic Edition* (Mustoe, et al. 43)

*McGraw-Hill Ryerson Chemistry 11, Ontario Edition* (Mustoe, et al. 163)

*Nelson Chemistry 11, Ontario Edition* (Jenkins, et al. 27)

*Nelson Chemistry 12: College Preparation, Ontario Edition* (Davies, et al. 80)

*Prentice Hall Chemistry: Connections to Our Changing World* (LeMay, et al. 107)

**SKILLS AND ATTITUDES OUTCOMES**

**C11-0-U1:** Use appropriate strategies and skills to develop an understanding of chemical concepts.

*Examples: analogies, concept frames, concept maps, manipulatives, particulate representations, role-plays, simulations, sort-and-predict frames, word cycles...*

**C11-0-U2:** Demonstrate an understanding of chemical concepts.

*Examples: use accurate scientific vocabulary, explain concepts to others, compare and contrast concepts, apply knowledge to new situations and/or contexts, create analogies, use manipulatives...*

**C11-0-S7:** Interpret patterns and trends in data, and infer and explain relationships.

---

**NOTES**



## SPECIFIC LEARNING OUTCOME

**C11-3-02:** Research the importance and applications of isotopes.

*Examples: nuclear medicine, stable isotopes in climatology, dating techniques...*

(1.0 hour)

SLO: C11-3-02

## SUGGESTIONS FOR INSTRUCTION

**Entry-Level Knowledge**

Students were introduced to isotopes in the treatment of learning outcome C11-3-01. As yet, they have little knowledge about the uses of isotopes.

**TEACHER NOTES**

In addressing this learning outcome, teachers may want to include a discussion of half-life, but should avoid a detailed treatment of radioactive decay equations.

Introduce students to the importance and applications of isotopes by relating the uses of various isotopes. Some examples are provided below. (**Note:** Students will find an abundance of isotopes with minimal information on each. Therefore, research assignments should reflect the variety of isotopes rather than detailed information on one isotope.)

Additional information can be found in the following appendices:

- Appendix 3.2: Don't Be an Isotope: Get the Facts on Isotopes
- Appendix 3.3: Isotopes Used in Medicine and Climatology
- Appendix 3.4: The Importance and Applications of Isotopes

**Isotope Applications****1. Radioactive Tracers in Medical Diagnosis**

- $^{131}\text{I}$  can be used to image the thyroid, heart, lungs, and liver, and to measure iodine levels in blood.
- $^{24}\text{Na}$  (a beta emitter with a half-life of 14.8 h) injected into the bloodstream as a salt solution can be monitored to trace the flow of blood and detect possible constrictions or obstructions in the circulatory system.
- PET (positron emission tomography) scans use  $^{15}\text{O}$  in  $\text{H}_2^{15}\text{O}$  and  $^{18}\text{F}$  bonded to glucose to measure energy metabolism in the brain.

**General Learning Outcome Connections**

- GLO A3:** Distinguish critically between science and technology in terms of their respective contexts, goals, methods, products, and values.
- GLO B4:** Demonstrate knowledge of and personal consideration for a range of possible science- and technology-related interests, hobbies, and careers.
- GLO D3:** Understand the properties and structures of matter, as well as various common manifestations and applications of the actions and interactions of matter.

**SKILLS AND ATTITUDES OUTCOMES**

**C11-0-R1:** Synthesize information obtained from a variety of sources.

Include: print and electronic sources, specialists, other resource people

**C11-0-R2:** Evaluate information obtained to determine its usefulness for information needs.

Examples: scientific accuracy, reliability, currency, relevance, balance of perspectives, bias...

**C11-0-R5:** Communicate information in a variety of forms appropriate to the audience, purpose, and context.

---

**2. Radioactive Isotopes in Medical Treatment**

- Implants of  $^{198}\text{Au}$  or mixtures of  $^{90}\text{Sr}$  and  $^{90}\text{Y}$  have been used to destroy pituitary and breast cancer tumours.
- Gamma rays from  $^{60}\text{Co}$  are used to destroy brain tumours.

**3. Oxygen Isotopes in Climatology and Geology**

Stable isotopes such as  $^{16}\text{O}$  and  $^{18}\text{O}$  were used to indicate global temperatures in the distant past. This can be done by determining the ratio of  $^{18}\text{O}$  to  $^{16}\text{O}$  in ice cores extracted from Earth's polar caps or from sediment cores exhumed from the ocean floor. There is a correlation between an excess of the light isotope,  $^{16}\text{O}$ , in precipitation and global temperatures.

When ice sheets grow in the polar regions during glacial periods, they incorporate water that has been evaporated in the low latitudes and carried to the poles in the form of water vapour, which is then precipitated as snow.

Evaporation favours the light isotope of oxygen,  $^{16}\text{O}$ , for reasons of simple kinetics, and so polar ice has proportionally more  $^{16}\text{O}$  than the seawater left behind when evaporation rates are high (warmer periods). This means that newly deposited ocean sediments will have a greater abundance of the *heavier isotope*,  $^{18}\text{O}$ , when world temperatures are higher than average. Therefore:

- When world ice volume increases during a glacial stage, the heavier isotope,  $^{18}\text{O}$ , *decreases* in polar ice and snow.
- When ice volume shrinks during warming (interglacial) periods, such as we have right now, the abundance of  $^{18}\text{O}$  *increases* in the world's oceans. This shows up in decreased  $^{18}\text{O}$  content in polar ice.

This *isotopic signature* can be preserved in certain shelled animals such as marine Foraminifera. These tiny bottom-dwellers secrete a silicate shell that carries the ratio of  $^{18}\text{O}/^{16}\text{O}$  consistent with what that ratio was in the seawater around it. "Heavy shell" = more ice on the planet. This makes for a very effective *paleothermometer* that can be used to correlate ocean temperatures, world climate, and sea-ice volumes. See Appendix 3.2 for a more detailed treatment.

## SPECIFIC LEARNING OUTCOME

C11-3-02: Research the importance and applications of isotopes.

Examples: nuclear medicine, stable isotopes in climatology, dating techniques...

(continued)



#### 4. Carbon and Hydrogen Isotopes in Atmospheric Nuclear Tests

Nuclear weapons tests put large and detectable amounts of certain radioactive isotopes into the atmosphere. After the near-elimination of nuclear bomb testing due to the Limited Test Ban Treaty in 1963, the carbon-14 ( $^{14}\text{C}$ ) concentration in the atmosphere began decreasing immediately. Anybody born *before* 1965 or so possesses a significantly higher concentration of  $^{14}\text{C}$  than someone born after atmospheric nuclear testing ended. Thus, we can tell how old many living organisms are (including humans) based on the recent history of  $^{14}\text{C}$  content in the atmosphere. Such sources of radiogenic isotopes are often described as coming from *anthropogenic* (human-generated) activities.

A detailed discussion of *tritium in the atmosphere* can be found at the following websites:



U.S. Environmental Protection Agency: Radiation Information:

<<http://www.epa.gov/radiation/radionuclides/tritium.htm>>

U.S. Geological Survey:

<[http://wwwrcamnl.wr.usgs.gov/isoig/period/h\\_iig.html](http://wwwrcamnl.wr.usgs.gov/isoig/period/h_iig.html)>

The U.S. Geological Survey also provides information related to periods of atmospheric nuclear testing.

#### 5. Isotopes in Dating Techniques

- Carbon-14, with a half-life of 5730 y, is used to determine the age of bones discovered at archeological sites because the  $^{14}\text{C}$  continues to decay over the years, whereas the amount present in the atmosphere is constant. The maximum age of an object for dating purposes using  $^{14}\text{C}$  is about 24 000 years, whereas a long-lived isotope such as  $^{238}\text{U}$  can be used to date materials up to  $4.5 \times 10^9$  years.
- Uranium-238 and lead-206 are commonly used to date very ancient objects such as minerals contained within rock samples.

#### Research/Reports

Students research and report on applications of isotopes in medicine, paleoclimatology (e.g., ice-core research), other dating techniques, and so on. WebQuests could be used to research the required information. Having students complete the search process on their own time would save some class time. The research reports could be presented in a variety of ways. See Appendix 3.4: The Importance and Application of Isotopes.

**SKILLS AND ATTITUDES OUTCOMES**

**C11-0-R1:** Synthesize information obtained from a variety of sources.

Include: print and electronic sources, specialists, other resource people

**C11-0-R2:** Evaluate information obtained to determine its usefulness for information needs.

*Examples: scientific accuracy, reliability, currency, relevance, balance of perspectives, bias...*

**C11-0-R5:** Communicate information in a variety of forms appropriate to the audience, purpose, and context.

---

**SUGGESTIONS FOR ASSESSMENT**

---

**Rubrics/Checklists**

See Appendix 10 for a variety of rubrics and checklists that can be used for self-assessment, peer assessment, and teacher assessment.

**Research Reports**

Have students conduct and report their research either individually or in small groups. The information collected could be presented as

- written reports
- oral presentations
- bulletin board displays
- multimedia presentations

**Visual Displays**

Students could present what they have learned using

- posters
- pamphlets
- bulletin board displays
- models

Each of these presentation styles could be assessed using an appropriate rubric created with students prior to the assignment. Samples of presentation rubrics are provided in Appendix 10 of this document.



### SPECIFIC LEARNING OUTCOME

**C11-3-02:** Research the importance and applications of isotopes.

*Examples: nuclear medicine, stable isotopes in climatology, dating techniques...*

(continued)

---

### LEARNING RESOURCES LINKS



*Chemistry* (Chang 50, 564, 875, 934, 966)

*Chemistry* (Zumdahl and Zumdahl 54, 56, 83, 84, 88, 878)

*Chemistry: The Central Science* (Brown, et al. 43, 839)

*Chemistry: Concepts and Applications* (Phillips, Strozak, and Wistrom 62, 756)

*Chemistry: The Molecular Nature of Matter and Change* (Silberberg 52, 56, 1042)

*Glencoe Chemistry: Matter and Change* (Dingrando, et al. 100)

*Introductory Chemistry: A Foundation* (Zumdahl 95, 97, 113, 117, 551)

*McGraw-Hill Ryerson Chemistry, Combined Atlantic Edition* (Mustoe, et al. 43)

*McGraw-Hill Ryerson Chemistry 11, Ontario Edition* (Mustoe, et al. 37, 162, 170)

*Nelson Chemistry 11, Ontario Edition* (Jenkins, et al. 27, 165)

*Nelson Chemistry 12, Ontario Edition* (van Kessel, et al. 165)

*Nelson Chemistry 12: College Preparation, Ontario Edition* (Davies, et al. 15, 80)

*Prentice Hall Chemistry: Connections to Our Changing World* (LeMay, et al. 107)

Teachers interested in collecting data, along with their students, for the analysis of isotopes in Manitoba precipitation can contact:

Department of Geography  
Manitoba Network for Isotopes in Precipitation (MNIP)  
The University of Winnipeg

**SKILLS AND ATTITUDES OUTCOMES**

**C11-0-R1:** Synthesize information obtained from a variety of sources.

Include: print and electronic sources, specialists, other resource people

**C11-0-R2:** Evaluate information obtained to determine its usefulness for information needs.

*Examples: scientific accuracy, reliability, currency, relevance, balance of perspectives, bias...*

**C11-0-R5:** Communicate information in a variety of forms appropriate to the audience, purpose, and context.

---

**NOTES**



**SPECIFIC LEARNING OUTCOME**

**C11-3-03:** Write formulas and names for polyatomic compounds using International Union of Pure and Applied Chemistry (IUPAC) nomenclature.

(2.0 hours)

SLO: C11-3-03

**SUGGESTIONS FOR INSTRUCTION****Entry-Level Knowledge**

The following learning outcomes were addressed in Grade 10 Science:

- S2-2-01: Relate an element's position on the periodic table to its combining capacity (valence).  
Include: ionic bonds, covalent bonds
- S2-2-02: Explain, using the periodic table, how and why elements combine in specific ratios to form compounds.  
Include: ionic bonds, covalent bonds
- S2-2-03: Write formulas and names of binary ionic compounds.  
Include: IUPAC guidelines and rationale for their use
- S2-2-04: Write formulas and names of molecular compounds using prefixes.  
Include: mono, di, tri, tetra

**Assessing Prior Knowledge**

Check for student understanding of prior knowledge and review as necessary. Prior knowledge can be reviewed and/or assessed by using any of the KWL strategies (e.g., Concept Map, Knowledge Chart, Think-Pair-Share, Word Cycle, Three-Point Approach, Compare and Contrast) found in Chapters 9 and 10 of *SYSTH*. These strategies can be used to review the following terms: anion, cation, valence (combining capacity), ionic bond, covalent bond, metal, non-metal, electron sharing, formula unit, and binary.

**TEACHER NOTES**

Indicate that IUPAC is an acronym for the International Union of Pure and Applied Chemistry. This worldwide organization is the governing body that oversees—among many tasks—the formal naming of chemical compounds (nomenclature).

When introducing polyatomic ions, begin with simple examples (e.g., hydroxide). Indicate that *polyatomic ions* are sometimes referred to as *complex ions* or *radicals*. A list of polyatomic ions can be found in Appendix 3.5: Names, Formulas, and Charges of Some Common Ions.

**General Learning Outcome Connections**

**GLO D3:** Understand the properties and structures of matter, as well as various common manifestations and applications of the actions and interactions of matter.

**SKILLS AND ATTITUDES OUTCOMES**

**C11-0-U1:** Use appropriate strategies and skills to develop an understanding of chemical concepts.

*Examples: analogies, concept frames, concept maps, manipulatives, particulate representations, role-plays, simulations, sort-and-predict frames, word cycles...*

**C11-0-U2:** Demonstrate an understanding of chemical concepts.

*Examples: use accurate scientific vocabulary, explain concepts to others, compare and contrast concepts, apply knowledge to new situations and/or contexts, create analogies, use manipulatives...*

**C11-0-S7:** Interpret patterns and trends in data, and infer and explain relationships.

---

Encourage students to determine formulas of compounds based on balancing ion charge, as opposed to the “criss-cross” method. Students may have seen the “criss-cross” method of determining the correct formula of a compound in a previous grade, but they should now be informed *why* this method works. Students may benefit from particulate representation activities to assist in formula determination. Paper shapes can be used to represent various cations and anions. The objective is to make a rectangular figure, which shows the correct ratio of ions.

**Activation Activity**

Students can play an Ionic Name Game in which they roll a pair of dice—one with representations of monoatomic cations and the other with monoatomic anions. Students will attempt to predict the correct formula and name of the binary ionic compound based on the ions. (See Appendix 3.6: Ionic Name Game.)

**Laboratory Activities**

1. In a lab activity found in *Microscale Chemistry Laboratory Manual* (Slater and Rayner-Canham, Experiment 14), students experimentally determine the relationship between positive metal ions and negative non-metal ions in a given formula. Various chloride solutions are titrated with silver nitrate using an eye dropper. The indicator, *dichlorofluorescein*, changes from white to pink when all the chloride ions in solution have reacted. By putting the data in a table form, students can see the relationship between positive and negative ions within a formula.
2. Another lab activity can be found in Appendix 3.7: Stoichiometry: The Formula of a Precipitate. Students can determine the formula of a precipitate, cobalt hydroxide,  $\text{Co}(\text{OH})_2$ . Although precipitate solutions are not formally addressed in Grade 11 Chemistry, students will find this lab interesting and beneficial.

**SPECIFIC LEARNING OUTCOME**

**C11-3-03:** Write formulas and names for polyatomic compounds using International Union of Pure and Applied Chemistry (IUPAC) nomenclature.

(continued)

**SUGGESTIONS FOR ASSESSMENT****Laboratory Reports**

The lab activities suggested for this learning outcome could be assessed as formal lab reports using the Laboratory Report Outline or the Laboratory Report Format (see *SYSTH* 11.38, 14.12) or by using questions and answers from the data collected from the activities.

**Paper-and-Pencil Tasks**

- Students should be able to write the names and formulas for both binary and tertiary compounds. Multivalent ions such as  $\text{Cu}^+$  and  $\text{Cu}^{2+}$  should be included. Students could create questions and test their classmates.
- Students should be able to write out an explanation of why a given formula is correct based on the ions and their total charge in the molecule.

**LEARNING RESOURCES LINKS**

*Chemistry* (Chang 59)

*Chemistry* (Zumdahl and Zumdahl 66)

*Chemistry: The Central Science* (Brown, et al. 49)

*Chemistry: Concepts and Applications* (Phillips, Strozak, and Wistrom 161)

*Chemistry: The Molecular Nature of Matter and Change* (Silberberg 63)

*Glencoe Chemistry: Matter and Change* (Dingrando, et al. 221)

*Glencoe Chemistry: Matter and Change: Laboratory Manual – Teacher Edition* (85–Investigation)

*Introductory Chemistry: A Foundation* (Zumdahl 134)

*McGraw-Hill Ryerson Chemistry, Combined Atlantic Edition* (Mustoe, et al. 25)

*McGraw-Hill Ryerson Chemistry 11, Ontario Edition* (Mustoe, et al. 97)

*Microscale Chemistry Laboratory Manual* (Slater and Rayner-Canham 39)

*Nelson Chemistry 11, Ontario Edition* (Jenkins, et al. 90)

*Nelson Chemistry 12: College Preparation, Ontario Edition* (Davies, et al. Appendix C5)

*Prentice Hall Chemistry: Connections to Our Changing World* (LeMay, et al. 231)

**SKILLS AND ATTITUDES OUTCOMES**

**C11-0-U1:** Use appropriate strategies and skills to develop an understanding of chemical concepts.

*Examples: analogies, concept frames, concept maps, manipulatives, particulate representations, role-plays, simulations, sort-and-predict frames, word cycles...*

**C11-0-U2:** Demonstrate an understanding of chemical concepts.

*Examples: use accurate scientific vocabulary, explain concepts to others, compare and contrast concepts, apply knowledge to new situations and/or contexts, create analogies, use manipulatives...*

**C11-0-S7:** Interpret patterns and trends in data, and infer and explain relationships.

---

**NOTES**



## SPECIFIC LEARNING OUTCOME

C11-3-04: Calculate the mass of compounds in atomic mass units.

(1.0 hour)

SLO: C11-3-04

## SUGGESTIONS FOR INSTRUCTION

**Entry-Level Knowledge**

The following learning outcomes were addressed in Grade 9 and Grade 10 Science, as well as in Grade 11 Chemistry:

- S1-2-04: Explain the atomic structure of an element in terms of the number of protons, electrons, and neutrons and explain how these numbers define atomic number and atomic mass.
- S2-2-02: Explain, using the periodic table, how and why elements combine in specific ratios to form compounds.  
Include: ionic bonds, covalent bonds
- S2-2-05: Investigate the Law of Conservation of Mass and recognize that mass is conserved in chemical reactions.
- C11-3-01: Determine average atomic mass using isotopes and their relative abundance.

Include: atomic mass unit (amu)

**Assessing Prior Knowledge**

Check for student understanding of prior knowledge and review as necessary. Prior knowledge can be reviewed and/or assessed by using any of the KWL strategies (e.g., Concept Map, Knowledge Chart, Think-Pair-Share—see *SYSTH*, Chapter 9).

**Activation Activity**

Use an Admit Slip to activate students' prior knowledge (see *SYSTH* 13.9-13.10).

**General Learning Outcome Connections**

**GLO D3:** Understand the properties and structures of matter, as well as various common manifestations and applications of the actions and interactions of matter.

**SKILLS AND ATTITUDES OUTCOMES**

**C11-0-U1:** Use appropriate strategies and skills to develop an understanding of chemical concepts.

*Examples: analogies, concept frames, concept maps, manipulatives, particulate representations, role-plays, simulations, sort-and-predict frames, word cycles...*

**C11-0-U2:** Demonstrate an understanding of chemical concepts.

*Examples: use accurate scientific vocabulary, explain concepts to others, compare and contrast concepts, apply knowledge to new situations and/or contexts, create analogies, use manipulatives...*

**C11-0-S7:** Interpret patterns and trends in data, and infer and explain relationships.

**TEACHER NOTES**

Review with students how subscripts indicate the number(s) of atoms in a molecule or formula unit. Differentiate between molecular mass and formula mass.

- *Molecular compounds*, also known as *molecules*, contain atoms linked together in discrete, electrically neutral particles. Two examples are O<sub>2</sub> and CO<sub>2</sub>. The mass of a molecule is called the *molecular mass*.
- *Ionic compounds* are composed of ions. Two examples are NaCl and CuSO<sub>4</sub>. The mass of an ionic compound is called the *formula mass*.

Students should calculate the molecular mass and formula mass of various compounds. The sum of the average atomic masses of the atoms in a chemical formula is the molecular mass or formula mass of the compound. Begin with binary compounds and progress toward polyatomic compounds. The molecular mass of Aspirin or acetylsalicylic acid, C<sub>9</sub>H<sub>8</sub>O<sub>4</sub>, can be calculated as follows:

$$\begin{aligned} \text{C}_9\text{H}_8\text{O}_4 &= 9\text{C} + 8\text{H} + 4\text{O} \\ &= (9 \times 12.01 \text{ amu}) + (8 \times 1.01 \text{ amu}) + (4 \times 16.00 \text{ amu}) \\ &= 180 \text{ amu} \end{aligned}$$

A Venn diagram would be an effective way to show similarities and differences between molecular mass and formula mass.

**Laboratory Activity**

A number of investigations can be done related to this learning outcome:

- Find the formula of a hydrate.
- Find the percentage of water in a hydrated salt.
- **Extension:** Calculate the percent composition by mass.

**SUGGESTIONS FOR ASSESSMENT****Paper-and Pencil Tasks: Written Test/Quiz**

Students could calculate the mass of various compounds, in amu, given the names and/or formulas of the compounds.



**SPECIFIC LEARNING OUTCOME**

**C11-3-04:** Calculate the mass of compounds in atomic mass units.

(continued)

---

**LEARNING RESOURCES LINKS**



*Chemistry* (Chang 76)

*Chemistry* (Zumdahl and Zumdahl 81)

*Chemistry: The Central Science* (Brown, et al. 41)

*Chemistry: Concepts and Applications* (Phillips, Strozak, and Wistrom 67)

*Chemistry: The Molecular Nature of Matter and Change* (Silberberg 88)

*Glencoe Chemistry: Matter and Change* (Dingrando, et al. 102)

*Introductory Chemistry: A Foundation* (Zumdahl 214)

*McGraw-Hill Ryerson Chemistry, Combined Atlantic Edition* (Mustoe, et al. 55)

*McGraw-Hill Ryerson Chemistry 11, Ontario Edition* (Mustoe, et al. 35)

*Nelson Chemistry 11, Ontario Edition* (Jenkins, et al. 164)

*Nelson Chemistry 12: College Preparation, Ontario Edition* (Davies, et al. 80)

*Prentice Hall Chemistry: Connections to Our Changing World* (LeMay, et al. 104, 110)

**SKILLS AND ATTITUDES OUTCOMES**

**C11-0-U1:** Use appropriate strategies and skills to develop an understanding of chemical concepts.

*Examples: analogies, concept frames, concept maps, manipulatives, particulate representations, role-plays, simulations, sort-and-predict frames, word cycles...*

**C11-0-U2:** Demonstrate an understanding of chemical concepts.

*Examples: use accurate scientific vocabulary, explain concepts to others, compare and contrast concepts, apply knowledge to new situations and/or contexts, create analogies, use manipulatives...*

**C11-0-S7:** Interpret patterns and trends in data, and infer and explain relationships.

---

**NOTES**



**SPECIFIC LEARNING OUTCOMES**

**C11-3-05:** Write and classify balanced chemical equations from written descriptions of reactions.

Include: polyatomic ions

(1.0 hour)

**C11-3-06:** Predict the products of chemical reactions, given the reactants and type of reaction.

Include: polyatomic ions

(1.0 hour)

SLO: C11-3-05  
SLO: C11-3-06

**SUGGESTIONS FOR INSTRUCTION****Entry-Level Knowledge**

The following learning outcomes were addressed in Grade 10 Science:

- S2-2-06: Balance chemical equations.  
Include: translation of word equations to balanced chemical reactions, and balanced chemical equations to word equations.
- S2-2-07: Investigate and classify chemical reactions as synthesis, decomposition, single displacement, double displacement, or combustion.

**Assessing Prior Knowledge**

Check for student understanding of prior knowledge and review as necessary. Prior knowledge can be reviewed and/or assessed by using any of the KWL strategies (e.g., Concept Map, Knowledge Chart, Think-Pair-Share—see *SYSTH*, Chapter 9).

**Discrepant Events/Demonstrations**

The following discrepant events may be used to review reaction types.

1. Place an unlit candle on a balance. Have students predict what will happen to the mass of the candle when the candle is burned. Allow the candle to burn and observe the mass decrease. Students should explain that the mass decrease is a result of the gaseous products of the combustion reaction.
2. Place some steel wool (Fe) on the balance and note the mass. Again, ask students to predict what will happen if the wool is burned. Burn the wool and note the mass increase. Students should explain that the mass increase is due to the synthesis reaction.

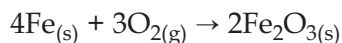
**General Learning Outcome Connections**

**GLO C4:** Demonstrate appropriate critical thinking and decision-making skills when choosing a course of action based on scientific and technological information.

**GLO D3:** Understand the properties and structures of matter, as well as various common manifestations and applications of the actions and interactions of matter.

**GLO E4:** Recognize that energy, whether transmitted or transformed, is the driving force of both movement and change, and is inherent within materials and in the interactions among them.

**SKILLS AND ATTITUDES OUTCOMES**

**C11-0-U1:** Use appropriate strategies and skills to develop an understanding of chemical concepts.

*Examples: analogies, concept frames, concept maps, manipulatives, particulate representations, role-plays, simulations, sort-and-predict frames, word cycles...*

**C11-0-U2:** Demonstrate an understanding of chemical concepts.

*Examples: use accurate scientific vocabulary, explain concepts to others, compare and contrast concepts, apply knowledge to new situations and/or contexts, create analogies, use manipulatives...*

**C11-0-S9:** Draw a conclusion based on the analysis and interpretation of data.

*Include: cause-and-effect relationships, alternative explanations, supporting or rejecting a hypothesis or prediction*

**Laboratory Activity**

Student knowledge of the characteristics of a chemical reaction can be reinforced through a lab activity. See Appendix 3.8: Indications of Chemical Reactions.

**TEACHER NOTES**

Students should have a solid understanding of balancing equations from Grade 10 Science. To review the different reaction types, teachers may wish to include lab activities and or demonstrations. When balancing equations, present students with more complex reactions that include polyatomic ions.

Students should be able to:

- Change word equations into balanced equations by inspection. Reactions should not be limited to one-to-one ratios. The following general rule works for most chemical reactions: Balance metals first, then ions, non-metals, and hydrogen, and finally oxygen. If there are no metals or ions, as in the case of an organic combustion reaction, carbon would be balanced first, then hydrogen, and finally oxygen.
- Include the states of the reactants and products (g, l, s, aq) when given the appropriate information in a question.
- Predict the products of a reaction when given the reactants and type of reaction. Begin with addition and decomposition reactions and progress toward single replacement, double replacement, and combustion reactions.

**Collaborative Teamwork**

Use the Jigsaw strategy in which each student becomes an “expert” on one type of reaction. Students meet as a larger group, with each student teaching classmates. Each expert devises questions for the other group members. (See *SYSTH* 3.19-3.20.)

**SUGGESTIONS FOR ASSESSMENT****Rubrics/Checklists**

See Appendix 10 for a variety of rubrics and checklists that can be used for self-assessment, peer assessment, and teacher assessment.

**SPECIFIC LEARNING OUTCOMES**

**C11-3-05:** Write and classify balanced chemical equations from written descriptions of reactions.

Include: polyatomic ions

**C11-3-06:** Predict the products of chemical reactions, given the reactants and type of reaction.

Include: polyatomic ions

(continued)

**SYSTH Activity**

Have students complete a Three-Point Approach for each reaction type (see *SYSTH* 10.9-10.10, 10.22).

**Laboratory Report**

The lab activities could be assessed as formal lab reports using the Laboratory Report Outline or the Laboratory Report Format (see *SYSTH* 11.38, 14.12) or by using questions and answers from the data collected from the activities.

**Journal Writing**

Students could write journal entries about interesting demonstrations and lab activities.

**Paper-and-Pencil Tasks**

1. Given the written description of a chemical reaction, students write balanced chemical equations and identify the type of reaction.

*Example:*

When magnesium metal is burned in air, a white solid forms. Write the balanced chemical equation for the reaction, including the states, and indicate the type of reaction.

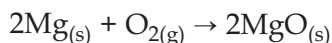

2. Given the reactants and type of chemical reaction, students predict the products and write a balanced chemical equation.

*Example:*

When zinc is treated with hydrochloric acid, a gas is produced. Write the balanced chemical equation for the reaction and indicate the type of reaction.

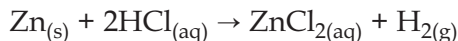
**Student Activity: Written Test/Quiz**

Students develop their own questions and share them with their classmates for additional practice. The student-developed questions may be included in a quiz or test.

### SKILLS AND ATTITUDES OUTCOMES

**C11-0-U1:** Use appropriate strategies and skills to develop an understanding of chemical concepts.

*Examples: analogies, concept frames, concept maps, manipulatives, particulate representations, role-plays, simulations, sort-and-predict frames, word cycles...*

**C11-0-U2:** Demonstrate an understanding of chemical concepts.

*Examples: use accurate scientific vocabulary, explain concepts to others, compare and contrast concepts, apply knowledge to new situations and/or contexts, create analogies, use manipulatives...*

**C11-0-S9:** Draw a conclusion based on the analysis and interpretation of data.

*Include: cause-and-effect relationships, alternative explanations, supporting or rejecting a hypothesis or prediction*

---

### LEARNING RESOURCES LINKS

---



*Chemistry (Chang 92)*

*Chemistry (Zumdahl and Zumdahl 102)*

*Chemistry: The Central Science (Brown, et al. 76)*

*Chemistry: Concepts and Applications (Phillips, Strozak, and Wistrom 198)*

*Chemistry: The Molecular Nature of Matter and Change (Silberberg 102)*

*Glencoe Chemistry: Matter and Change (Dingrando, et al. 353)*

*Introductory Chemistry: A Foundation (Zumdahl 155)*

*McGraw-Hill Ryerson Chemistry, Combined Atlantic Edition (Mustoe, et al. 29)*

*McGraw-Hill Ryerson Chemistry 11, Ontario Edition (Mustoe, et al. 114)*

*Nelson Chemistry 11, Ontario Edition (Jenkins, et al. 210)*

*Prentice Hall Chemistry: Connections to Our Changing World (LeMay, et al. 282)*



## SPECIFIC LEARNING OUTCOMES

**C11-3-07:** Describe the concept of the mole and its importance to measurement in chemistry.

(0.75 hour)

**C11-3-08:** Calculate the molar mass of various substances.

(0.25 hour)

SLO: C11-3-07  
SLO: C11-3-08

## SUGGESTIONS FOR INSTRUCTION

## Entry-Level Knowledge

Students have not previously studied the concepts addressed in learning outcomes C11-3-07 and C11-3-08. A light treatment of significant figures was given in *Senior 2 Science: A Foundation for Implementation* (Appendix 7).

## TEACHER NOTES

Lorenzo Romano Amedeo Carlo Avogadro (1776–1856) did not actually determine the number known as *Avogadro's number*. Avogadro worked principally with gases, attempting to demonstrate that equal volumes of gas under the same conditions contain the same number of particles. His work with particles on the molecular level laid the groundwork for further investigations by other scientists, such as Jean Baptiste Perrin (1870–1942). Perrin measured the displacement of colloidal particles that exhibited *Brownian* movement. He then used the results from these experiments to calculate the first value of what we call *Avogadro's constant*.

Discuss with students how Avogadro's hypothesis revolutionized thinking in chemistry and share how "N" was found in the past, compared to how it might be determined today.

The following article explains four definitions of a mole:

Barton, L. "The Definition of a Mole." *CHEM 13 NEWS* 327 (Feb. 2005): 10–11.

## General Learning Outcome Connections

- GLO A1:** Recognize both the power and limitations of science as a way of answering questions about the world and explaining natural phenomena.
- GLO A4:** Identify and appreciate contributions made by women and men from many societies and cultural backgrounds that have increased our understanding of the world and brought about technological innovations.
- GLO B1:** Describe scientific and technological developments—past and present—and appreciate their impact on individuals, societies, and the environment, both locally and globally.
- GLO D3:** Understand the properties and structures of matter, as well as various common manifestations and applications of the actions and interactions of matter.

**SKILLS AND ATTITUDES OUTCOMES**

**C11-0-U1:** Use appropriate strategies and skills to develop an understanding of chemical concepts.

*Examples: analogies, concept frames, concept maps, manipulatives, particulate representations, role-plays, simulations, sort-and-predict frames, word cycles...*

**C11-0-U2:** Demonstrate an understanding of chemical concepts.

*Examples: use accurate scientific vocabulary, explain concepts to others, compare and contrast concepts, apply knowledge to new situations and/or contexts, create analogies, use manipulatives...*

**Laboratory Activities**

1. Have students do a small-scale investigation to determine the value of Avogadro's number. The procedure involves generating a monolayer of stearic acid. See *Microscale Chemistry Laboratory Manual* (Slater and Rayner-Canham 29).
2. Other student activities can be done to determine the size and mass of an oleic acid molecule or a molecular film layer.



A number of websites outline procedures related to student activities with oleic acid, including the following:

Georgia Perimeter College. Determination of the Length of an Oleic Acid Molecule and Avogadro's Number:

<<http://www.gpc.edu/~ddonald/chemlab/oleicavagno.html>>

Science Teachers' Resource Center. Oleic Acid Lab:

<<http://chem.lapeer.org/chem1docs/OleicAcidLab.html>>

Summer Research Program for Science Teachers. How Big Is a Molecule?

<<http://www.scienceteacherprogram.org/chemistry/Flomberg00.html>>

The following websites offer a key application to how antibiotics penetrate membrane layers in the body by virtue of molecular size.

The Chemical Heritage Foundation. Molecular Size: Oleic Acid Monolayers:

<<http://www.chemheritage.org/educationalservices/pharm/antibiot/activity/size.htm>>

---. Antibiotics in Action: Teacher's Guide: <<http://www.chemheritage.org/educationalservices/pharm/tg/antibiot/activity/size.htm>>

3. In another small-scale investigation, students estimate the size of a mole by comparing the average mass of split peas to the volume of a mole of peas. See *Microscale Chemistry Laboratory Manual* (Slater and Rayner-Canham 81).

**TEACHER NOTES**

Carefully explain to students the relationships among moles, the number of particles, and mass in grams. Emphasize that the *mole* is the central unit in most calculations. Encourage students to use dimensional analysis during problem solving. The intent of Grade 11 Chemistry is to limit calculations with Avogadro's number and focus more on practical calculations with mass, volume, and moles.

Advise students that in some chemistry texts and reference materials, *molar mass* is referred to as *molecular weight*.



## SPECIFIC LEARNING OUTCOMES

**C11-3-07:** Describe the concept of the mole and its importance to measurement in chemistry.

**C11-3-08:** Calculate the molar mass of various substances.

(continued)

The following calculation would be considered an extension of these learning outcomes: What is the mass of 6 atoms of ammonium phosphate?

Over the years, chemistry teachers have tried many ways to assist students in mastering these sorts of calculations. One of these methods is provided below for information. When converting from one unit to another, always place the unknown on top, as shown in the example. Then solve for "X" (unknown) either by cross-multiplying or simply by dividing.

**Sample Problems**

1. How many moles are in 2.3 g of sodium atoms?

$$\frac{X}{1 \text{ mole}} = \frac{2.3 \text{ g}}{23.0 \text{ g}}$$

By dividing, the gram units cancel, leaving mole units for the answer. The units are still cross-multiplied.

$$X = 0.10 \text{ mole (2 sig. figures)}$$

2. The same method works for finding how many moles are in  $2.41 \times 10^{23}$  atoms of copper.

$$\frac{X}{1 \text{ mole}} = \frac{2.41 \times 10^{23} \text{ atoms}}{6.02 \times 10^{23} \text{ atoms}}$$

The atom units cancel, leaving the answer in moles.

$$X = 0.400 \text{ mole (3 sig. figures)}$$

3. When the conversion is done in the other direction, then cross-multiplying solves the ratio.

What is the mass of 0.25 mole of NaOH?

$$\frac{X}{40.0 \text{ g}} = \frac{0.250 \text{ mole}}{1 \text{ mole}}$$

$$X = 10.0 \text{ g (3 sig. figures)}$$

Have students check whether their answers are reasonable. By writing the ratios in this way, students are more likely to see the relationship between what is given and what is to be found. Unit (dimensional) analysis should be continued as a process in students' solutions in order to reinforce results obtained from the mole ratios.

**SKILLS AND ATTITUDES OUTCOMES**

**C11-0-U1:** Use appropriate strategies and skills to develop an understanding of chemical concepts.

*Examples: analogies, concept frames, concept maps, manipulatives, particulate representations, role-plays, simulations, sort-and-predict frames, word cycles...*

**C11-0-U2:** Demonstrate an understanding of chemical concepts.

*Examples: use accurate scientific vocabulary, explain concepts to others, compare and contrast concepts, apply knowledge to new situations and/or contexts, create analogies, use manipulatives...*

---

**Laboratory Activity**

Appendix 3.9: Determining the Molar Mass of a Gas describes a lab activity in which students can determine the molar mass of butane with accuracy.

Many other activities can be done with moles and mass. For example, have students pre-calculate the amounts required for the lab they will conduct for learning outcome C11-3-14.

**SUGGESTIONS FOR ASSESSMENT**

---

**Rubrics/Checklists**

See Appendix 10 for a variety of rubrics and checklists that can be used for self-assessment, peer assessment, and teacher assessment.

**Laboratory Reports**

The activities outlined for these learning outcomes could be assessed either as formal lab reports using the Laboratory Report Format (see *SYSTH* 14.12) or by using questions and answers from the data collected from the activities.

**Visual Displays**

Students could create a visual diagram or a concept map to illustrate how to convert from one unit to another.

**Journal Writing**

Students could create a poem, letter, greeting card, or poster inviting parents to a “Mole Day” celebration on October 23 from 6.02 a.m. to 6.02 p.m. The reference comes from linking Avogadro’s number ( $6.02 \times 10^{23}$  particles) to a specific date and time on October 23 (i.e., 10/23 at 6:02). For the second semester, the “Molar Equinox” occurs on April 23. We use this date for convenience, as it is six months from October 23 (hence, we get our  $6 \times 10^{23}$  again).

Each of these presentation forms could be assessed using an appropriate rubric created with students prior to the assignment. Samples of presentation rubrics are provided in Appendix 10 of this document.





#### SPECIFIC LEARNING OUTCOMES

**C11-3-07:** Describe the concept of the mole and its importance to measurement in chemistry.

**C11-3-08:** Calculate the molar mass of various substances.

(continued)

---

#### LEARNING RESOURCES LINKS

---



*Chemistry* (Chang 77)

*Chemistry* (Zumdahl and Zumdahl 86)

*Chemistry: The Central Science* (Brown, et al. 86)

*Chemistry: Concepts and Applications* (Phillips, Strozak, and Wistrom 405)

*Chemistry: The Molecular Nature of Matter and Change* (Silberberg 87)

*Glencoe Chemistry: Matter and Change* (Dingrando, et al. 310)

*Introductory Chemistry: A Foundation* (Zumdahl 216)

*McGraw-Hill Ryerson Chemistry, Combined Atlantic Edition* (Mustoe, et al. 42)

*McGraw-Hill Ryerson Chemistry 11, Ontario Edition* (Mustoe, et al. 172)

*Microscale Chemistry Laboratory Manual* (Slater and Rayner-Canham 29, 81,  
Experiment 10: Molar Mass of a Gas)

*Nelson Chemistry 11, Ontario Edition* (Jenkins, et al. 168)

*Nelson Chemistry 12: College Preparation, Ontario Edition* (Davies, et al. 83)

*Prentice Hall Chemistry: Connections to Our Changing World* (LeMay, et al. 310)

**SKILLS AND ATTITUDES OUTCOMES**

**C11-0-U1:** Use appropriate strategies and skills to develop an understanding of chemical concepts.

*Examples: analogies, concept frames, concept maps, manipulatives, particulate representations, role-plays, simulations, sort-and-predict frames, word cycles...*

**C11-0-U2:** Demonstrate an understanding of chemical concepts.

*Examples: use accurate scientific vocabulary, explain concepts to others, compare and contrast concepts, apply knowledge to new situations and/or contexts, create analogies, use manipulatives...*

---

**NOTES**



## SPECIFIC LEARNING OUTCOME

**C11-3-09:** Calculate the volume of a given mass of a gaseous substance from its density at a given temperature and pressure.

Include: molar volume calculation

(1.5 hours)

SLO: C11-3-09

## SUGGESTIONS FOR INSTRUCTION

## Entry-Level Knowledge

Students have previously examined the property of density in solids, liquids, and gases. The following specific learning outcome was addressed in Grade 8 Science:

- 8-3-06: Measure, calculate, and compare densities of solids, liquids, and gases.

Students have also solved problems with the *density = mass/unit volume* ( $d = m/v$ ) relationship using the appropriate units. Teachers may, however, need to review and assess student knowledge of this concept. The units commonly used previously related to solution concentration (e.g., grams/100 mL solvent).

Students have been introduced to the phases of matter, and have received an explanation for the properties of gases using the Kinetic Molecular Theory.

## TEACHER NOTES

Teachers will remember that, for a gas to behave as an *ideal gas*, the intermolecular forces must be as low in value as possible. To accomplish this, the pressure of a gas must be much less than 1 atmosphere and the temperature must be relatively high. In addition, compliance with ideal gas properties varies significantly from one gas to another (Silberberg 207). Due to the complexity of this issue, assume that all gases are *ideal* for Grade 11 Chemistry.

Most high school chemistry texts define the ideal molar volume of *any* gas at STP to be 22.414 L. Students should be given all the units for STP 0°C and one of the following: 101.3 kPa, 760 mmHg, or 1.00 atm.

## General Learning Outcome Connections

**GLO D3:** Understand the properties and structures of matter, as well as various common manifestations and applications of the actions and interactions of matter.

**SKILLS AND ATTITUDES OUTCOMES**

**C11-0-U1:** Use appropriate strategies and skills to develop an understanding of chemical concepts.

*Examples: analogies, concept frames, concept maps, manipulatives, particulate representations, role-plays, simulations, sort-and-predict frames, word cycles...*

**C11-0-U2:** Demonstrate an understanding of chemical concepts.

*Examples: use accurate scientific vocabulary, explain concepts to others, compare and contrast concepts, apply knowledge to new situations and/or contexts, create analogies, use manipulatives...*

**C11-0-S7:** Interpret patterns and trends in data, and infer and explain relationships.

---

In fact, most gases vary from 22.414 L even at STP. A list of molar volumes at STP follows (Silberberg 207):

• Ammonia gas (NH <sub>3</sub> )	22.079 L
• Chlorine gas (Cl <sub>2</sub> )	22.184 L
• Carbon dioxide gas (CO <sub>2</sub> )	22.260 L
• Oxygen gas (O <sub>2</sub> )	22.390 L
• Argon (Ar)	22.397 L
• <b>Ideal gas</b>	<b>22.414 L</b>
• Neon gas (Ne)	22.422 L
• Hydrogen gas (H <sub>2</sub> )	22.432 L
• Helium gas (He)	22.435 L

If students use three significant figures, calculations will closely approximate the value 22.4 L. A number of sample calculations follow.

**Class Activities**

Using a gas density table (see Appendix 3.10: Gas Density Table), have students calculate the molar volume of common gases and the volume of a given mass of a gaseous substance at a given temperature and pressure. Have students solve problems requiring conversions between mass and volume. Encourage them to use logic and reasoning, rather than relying on algorithms and ratios.

**Sample Problems**

Simple problems using the molar volume would include the following.

*Examples (with notes):*

1. Determine the volume of 8.00 g of oxygen gas at STP.
2. How many moles would be in 8.96 L of gas at STP?

If students are informed that the molar volume at 25°C and 1.00 atm is 24.5 L/mole, then the following types of problems can also be done.

3. Find the volume of 29.9 g of argon gas at 25.0°C and 1.00 atm.

Students can confirm the value for the molar volume of a gas by using the density of the gas.

**SPECIFIC LEARNING OUTCOME**

**C11-3-09:** Calculate the volume of a given mass of a gaseous substance from its density at a given temperature and pressure.

Include: molar volume calculation

(continued)

4. Calculate the molar volume of hydrogen gas if its density is 0.08999 g/L at 0°C and 760 mm of mercury.

Density is defined as mass per unit volume.

$$D = \frac{M}{V} \text{ or } V = \frac{M}{D}$$

$$V = \frac{2.02 \text{ g} \cdot \text{mole}^{-1}}{0.08999 \text{ g} \cdot \text{L}^{-1}} = 22.4 \text{ L/mole}$$

Conversely, students could calculate the density of a gas at STP using the molar volume and the molar mass of the gas.

**Laboratory Activity/Demonstration**

The following activity not only gives good results, but also provides students with an opportunity to learn and practise safe lab skills.

A butane lighter is massed before and after the fuel has been released as a gas into a collecting chamber. This measurement is the mass of the gas released into the water. The accuracy of this lab depends to a great extent on the accuracy of the collecting chamber. An inverted funnel could be inserted into a eudiometer tube to collect more effectively any gas evolved. By knowing the accurate volume at a measured temperature and pressure, we can convert the volume of gas to what it would occupy at STP. Then, using 22.4 L/mole, we can calculate the moles of gas released. By dividing the mass of the gas released by the number moles of gas, we can calculate the molar mass of the gas. The gas should be butane,  $C_4H_{10}$ . Make a comparison with the correct molar mass. See *McGraw-Hill Ryerson Chemistry 11* (Mustoe, *et al.* 496).

**Sample Problems**

1. Calculate the molar mass of a gas if its density at 27.0°C and 1.5 atm is 1.95 g/L. What is the gas?

$$D = \frac{M}{V} \quad \text{We know neither } M \text{ nor } V \text{ at these conditions, but we can change } 22.414 \text{ L to these conditions using the combined gas laws.}$$

22.414 L at 273 K and 1.0 atm

\_\_\_\_\_ L at 300 K and 1.5 atm

$$\frac{22.414 \text{ L} \times 300 \text{ K} \times 1.0 \text{ atm}}{273 \text{ K} \times 1.5 \text{ atm}} = 16.4 \text{ L}$$

**SKILLS AND ATTITUDES OUTCOMES**

**C11-0-U1:** Use appropriate strategies and skills to develop an understanding of chemical concepts.

*Examples: analogies, concept frames, concept maps, manipulatives, particulate representations, role-plays, simulations, sort-and-predict frames, word cycles...*

**C11-0-U2:** Demonstrate an understanding of chemical concepts.

*Examples: use accurate scientific vocabulary, explain concepts to others, compare and contrast concepts, apply knowledge to new situations and/or contexts, create analogies, use manipulatives...*

**C11-0-S7:** Interpret patterns and trends in data, and infer and explain relationships.

$$\begin{aligned} M &= D \times V \\ &= \frac{1.95 \text{ g}}{\cancel{\text{L}}} \times \frac{16.4 \cancel{\text{L}}}{\text{mole}} \\ &= 32.0 \text{ g/mole (3 sig. figures)} \end{aligned}$$

The gas could be O<sub>2</sub>.

2. Calculate the density of ethene gas, C<sub>2</sub>H<sub>4</sub>, at -73°C and 0.445 atm.

To use  $D = \frac{M}{V}$  we must find the molar volume at the given conditions.

22.414 L at 273 K and 1.0 atm

\_\_\_\_\_ L at 200 K and 0.445 atm

$$\frac{22.414 \text{ L} \times 200 \cancel{\text{K}} \times 1.0 \cancel{\text{atm}}}{273 \cancel{\text{K}} \times 0.445 \cancel{\text{atm}}} = 36.9 \text{ L}$$

$$\begin{aligned} \text{Then } D &= \frac{M}{V} \\ &= \frac{28.04 \text{ g} \cdot \cancel{\text{mole}^{-1}}}{36.9 \text{ L} \cdot \cancel{\text{mole}^{-1}}} \\ &= 0.760 \text{ g/L} \end{aligned}$$

Problems can also be connected to grams and moles.

3. Calculate the volume of 11.0 g of carbon dioxide gas at 173°C and 55.6 kPa.

$$\begin{aligned} \text{Moles} &= \frac{11.0 \text{ g}}{44.0 \text{ g} \cdot \text{mol}^{-1}} \\ &= 0.250 \text{ mol} \end{aligned}$$

$$\begin{aligned} \text{Volume at STP} &= 0.25 \text{ mol} \times 22.4 \text{ L} \\ &= 5.60 \text{ L} \end{aligned}$$

5.60 L at 273 K and 101.3 kPa

\_\_\_\_\_ L at 446 K and 55.6 kPa



**SPECIFIC LEARNING OUTCOME**

**C11-3-09:** Calculate the volume of a given mass of a gaseous substance from its density at a given temperature and pressure.

Include: molar volume calculation

(continued)

$$\frac{5.60 \text{ L} \times 446 \text{ K} \times 101.3 \text{ kPa}}{273 \text{ K} \times 55.6 \text{ kPa}}$$

Answer = 16.8 L of gas.

**Extension**

Other problems are possible in combination with the gas laws once students have completely understood the concept of molar volume.



**SUGGESTIONS FOR ASSESSMENT**

**Paper-and-Pencil Tasks**

Students solve problems using the molar volume and the definition of density. Most chemistry texts provide a reasonable selection of simple and advanced problems.

**Rubrics/Checklists**

See Appendix 10 for a variety of rubrics and checklists that can be used for self-assessment, peer assessment, and teacher assessment.

**Journal Writing**

Students may want to reflect, in their journals, on the results of the classroom activities related to specific learning outcome C11-3-09.

**SKILLS AND ATTITUDES OUTCOMES**

**C11-0-U1:** Use appropriate strategies and skills to develop an understanding of chemical concepts.

*Examples: analogies, concept frames, concept maps, manipulatives, particulate representations, role-plays, simulations, sort-and-predict frames, word cycles...*

**C11-0-U2:** Demonstrate an understanding of chemical concepts.

*Examples: use accurate scientific vocabulary, explain concepts to others, compare and contrast concepts, apply knowledge to new situations and/or contexts, create analogies, use manipulatives...*

**C11-0-S7:** Interpret patterns and trends in data, and infer and explain relationships.

---

**LEARNING RESOURCES LINKS**

---



*Chemistry* (Chang 180)

*Chemistry* (Zumdahl and Zumdahl 205)

*Chemistry: The Central Science* (Brown, et al. 279)

*Chemistry: The Molecular Nature of Matter and Change* (Silberberg 189, 207)

*McGraw-Hill Ryerson Chemistry, Combined Atlantic Edition* (Mustoe, et al. 66)

*McGraw-Hill Ryerson Chemistry 11, Ontario Edition* (Mustoe, et al. 490, 496)

*Microscale Chemistry Laboratory Manual* (Slater and Rayner-Canham, Experiment 9)

**Note:** Many of the resources use the Ideal Gas Equation ( $PV = nRT$ ) or modifications to this relationship to calculate density and molar volume. However, the calculations can be done by changing conditions to STP and then using  $22.414 \text{ L} \cdot \text{mole}^{-1}$ .



**SPECIFIC LEARNING OUTCOME**

**C11-3-10:** Solve problems requiring interconversions between moles, mass, volume, and number of particles.

(3.0 hours)

SLO: C11-3-10

**SUGGESTIONS FOR INSTRUCTION****Entry-Level Knowledge**

Students have not previously studied the concepts addressed in learning outcome C11-3-10.

**TEACHER NOTES****Historical Connection**

Since 1865 there have been over 80 determinations of what we now call Avogadro's number or constant. The name Avogadro's number is an honorary name given as a result of the distinguished work done by Lorenzo Romano Amedeo Carlo Avogadro. He worked with gases, attempting to prove that equal volumes of gas under the same conditions contain the same number of particles.

Avogadro's work with particles on the molecular level laid the groundwork for further investigations by other scientists, such as Jean Baptiste Perrin and Josef Loschmidt. Perrin measured the displacement of colloidal particles that exhibit Brownian motion, and he used the results from these experiments to calculate the first value of Avogadro's constant. Loschmidt's research was based on the Kinetic Molecular Theory.



For a summary of the research done on Avogadro's number, see the following website:

Furtsch, T.A. "Some Notes on Avogadro's Number,  $6.022 \times 10^{23}$ ." Tennessee Technological University: <<http://iweb.tntech.edu/chem281-tf/avogadro.htm>>.

Scroll down to the link "Loschmidt's Number" near the bottom of the page. The summary describes both the original methods that were used and the more modern methods using X-ray diffraction and radioactivity.

Search for other websites containing information on Avogadro. Use your favourite search engine for this.

The official value listed by the National Institute of Standards and Technology (NIST) for Avogadro's constant is  $6.0221415 \times 10^{23} \text{ mol}^{-1}$ .

**General Learning Outcome Connections**

**GLO D3:** Understand the properties and structures of matter, as well as various common manifestations and applications of the actions and interactions of matter.

**GLO E1:** Describe and appreciate the similarity and diversity of forms, functions, and patterns within the natural and constructed world.

**SKILLS AND ATTITUDES OUTCOMES**

**C11-0-U1:** Use appropriate strategies and skills to develop an understanding of chemical concepts.

*Examples: analogies, concept frames, concept maps, manipulatives, particulate representations, role-plays, simulations, sort-and-predict frames, word cycles...*

**C11-0-U2:** Demonstrate an understanding of chemical concepts.

*Examples: use accurate scientific vocabulary, explain concepts to others, compare and contrast concepts, apply knowledge to new situations and/or contexts, create analogies, use manipulatives...*

**C11-0-S7:** Interpret patterns and trends in data, and infer and explain relationships.

Discuss with students how Avogadro's hypothesis revolutionized thinking in chemistry, and share how "N" was originally found, compared to the modern methods used today.

Students usually have a difficult time relating to such a large number. It is helpful to provide examples.

**Sample Problems**

1. If we had Avogadro's number of pennies to divide among all the people in the world, how much would each person get?

As of January 15, 2005, the world population was estimated to be 6,412,930,900.

$$\frac{6.02 \times 10^{23} \text{ pennies}}{6,412,930,900 \text{ people}} = 9.3873 \times 10^{13} \text{ pennies or approximately } \$939,000,000,000$$

2. If Avogadro's number of sheets of paper were stacked one on top of one another, the pile would reach past our solar system.
3. Avogadro's number of grains of rice would cover the surface of the Earth to a depth of 75 m. See *Prentice Hall Chemistry: Connections to Our Changing World* (LeMay, et al. 319).

Engage students further with practical problems relating to the conversion of mass, moles of substance, and volume units. Less emphasis should be placed on the conversion of numbers of particles to these other units.

In the following examples, devote particular attention to the use of correct units. Recall that students used unit analysis with the problems in Topic 2, which addressed the gas laws.

**Sample Problems**

1. Determine the mass of 0.250 mol of  $\text{NH}_4\text{OH}$ .

$$0.250 \text{ mol} \times \frac{35.0 \text{ g}}{\text{mol}} = 8.75 \text{ g}$$



## SPECIFIC LEARNING OUTCOME

**C11-3-10:** Solve problems requiring interconversions between moles, mass, volume, and number of particles.

(continued)

2. How many particles are in 2.0 mol of C atoms?

If 1.0 mol =  $6.02 \times 10^{23}$ , then 2.0 mol should be twice as much.

$$2.0 \cancel{\text{mol}} \times \frac{6.02 \times 10^{23} \text{ particles}}{\cancel{\text{mol}}} = 12.04 \times 10^{23} \text{ particles}$$

or  $1.2 \times 10^{24}$  particles (2 sig. figures)

3. What would be the volume of 1.70 g of ammonia gas,  $\text{NH}_3$ , at STP?

$$\frac{1.70 \text{ g}}{17.0 \text{ g} \cdot \cancel{\text{mol}^{-1}}} \times 22.4 \text{ L} \cdot \cancel{\text{mol}^{-1}}$$

Answer = 2.24 L (3 sig. figures)

4. How many moles in  $4.82 \times 10^{24}$  particles?

$$\frac{4.82 \times 10^{24} \text{ particles}}{6.02 \times 10^{23} \text{ particles} \cdot \cancel{\text{mol}^{-1}}} = 8.01 \text{ mol}$$

5. Calculate the number of molecules of carbon dioxide gas,  $\text{CO}_2$ , in 1.68 L of gas at STP?

$$\frac{1.68 \cancel{\text{L}}}{22.4 \cancel{\text{L}} \cdot \cancel{\text{mol}^{-1}}} \times 6.02 \times 10^{23} \text{ particles} \cdot \cancel{\text{mol}^{-1}}$$

Answer =  $4.52 \times 10^{22}$  particles



## SUGGESTIONS FOR ASSESSMENT

**Rubrics/Checklists**

See Appendix 10 for a variety of rubrics and checklists that can be used for self-assessment, peer assessment, and teacher assessment.

**Research Reports**

Have students, individually or in small groups, conduct research on Avogadro's number and report their findings. The information collected could be presented as

- written reports
- oral presentations
- bulletin board displays
- multimedia presentations

**SKILLS AND ATTITUDES OUTCOMES**

**C11-0-U1:** Use appropriate strategies and skills to develop an understanding of chemical concepts.

*Examples: analogies, concept frames, concept maps, manipulatives, particulate representations, role-plays, simulations, sort-and-predict frames, word cycles...*

**C11-0-U2:** Demonstrate an understanding of chemical concepts.

*Examples: use accurate scientific vocabulary, explain concepts to others, compare and contrast concepts, apply knowledge to new situations and/or contexts, create analogies, use manipulatives...*

**C11-0-S7:** Interpret patterns and trends in data, and infer and explain relationships.

---

**Visual Displays**

Students could present examples that might illustrate better the size of Avogadro's number. The examples could be displayed as

- posters
- pamphlets
- bulletin board exhibits

**Journal Writing**

Students may want to write a journal entry about Avogadro's number or examine the reasons why his name has been attached to this quantity even though he was not responsible for suggesting the number. An interesting twist to the history would be to have Avogadro "as himself" write the letter in the first person.

**Creative Writing Activity**

For a distinctively different focus on the mole, see Appendix 3.11: Creative Mole: Writing Activity.

**LEARNING RESOURCES LINKS**

---



*Chemistry* (Chang 77)

*Chemistry* (Zumdahl and Zumdahl 87)

*Chemistry: The Central Science* (Brown, et al. 89)

*Chemistry: Concepts and Applications* (Phillips, Strozak, and Wistrom 406)

*Chemistry: The Molecular Nature of Matter and Change* (Silberberg 91)

*Glencoe Chemistry: Matter and Change* (Dingrando, et al. 320)

*Introductory Chemistry: A Foundation* (Zumdahl 216)

*McGraw-Hill Ryerson Chemistry, Combined Atlantic Edition* (Mustoe, et al. 50)

*McGraw-Hill Ryerson Chemistry 11, Ontario Edition* (Mustoe, et al. 172)

*Nelson Chemistry 11, Ontario Edition* (Jenkins, et al. 171)

*Nelson Chemistry 12: College Preparation, Ontario Edition* (Davies, et al. 82)

*Prentice Hall Chemistry: Connections to Our Changing World* (LeMay, et al. 319, 323)



## SPECIFIC LEARNING OUTCOME

**C11-3-11:** Determine empirical and molecular formulas from percent composition or mass data.

(0.5 hour)

SLO: C11-3-11

## SUGGESTIONS FOR INSTRUCTION

## Entry-Level Knowledge

Students have previously written formulas in Grade 10 Science and in Topic 3 of Grade 11 Chemistry:

- S2-2-04: Write formulas and names of molecular compounds using prefixes.  
Include: mono, di, tri, tetra
- C11-3-03: Write formulas and names for polyatomic compounds using International Union of Pure and Applied Chemistry (IUPAC) nomenclature.

However, students have not yet been informed that there are many types of formulas.

## TEACHER NOTES

Most Learning Resources Links listed for this outcome provide a detailed explanation of the various types of formulas, together with activities and labs designed to allow students to determine formulas experimentally.

General information about various types of formulas follows:

- In a *chemical* formula, the elements are represented by symbols, and a subscript number represents the number of each element.  
*Example:* The chemical formula for ethane is  $C_2H_6$ .
- An *empirical (simplest)* formula represents the relative number of atoms of each element in the compound.  
*Example:* The empirical formula for ethane is  $CH_3$ .
- A *molecular* formula represents the actual number of atoms of each element rather than a ratio of atoms.  
*Example:* The molecular formula for ethane is  $C_2H_6$ .

## General Learning Outcome Connections

**GLO D3:** Understand the properties and structures of matter, as well as various common manifestations and applications of the actions and interactions of matter.

**GLO E1:** Describe and appreciate the similarity and diversity of forms, functions, and patterns within the natural and constructed world.

## SKILLS AND ATTITUDES OUTCOMES

**C11-0-U1:** Use appropriate strategies and skills to develop an understanding of chemical concepts.

*Examples: analogies, concept frames, concept maps, manipulatives, particulate representations, role-plays, simulations, sort-and-predict frames, word cycles...*

**C11-0-U2:** Demonstrate an understanding of chemical concepts.

*Examples: use accurate scientific vocabulary, explain concepts to others, compare and contrast concepts, apply knowledge to new situations and/or contexts, create analogies, use manipulatives...*

**C11-0-S7:** Interpret patterns and trends in data, and infer and explain relationships.

Another way of representing this is:

Molecular formula = (empirical formula)<sub>n</sub>, where “n” is a whole number such as n = 1, etc.

In this example, n = 2

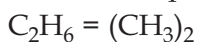

- A *structural* formula shows the bonds that connect each atom and provides information about the number of atoms.

*Example:* The structural formula for ethane is

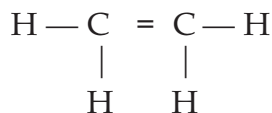

Since students will be determining formulas from percent composition and mass, remind them that there is a distinction between molecular and ionic compounds. In the strictest sense, it is not correct to say that 58.5 g/mol is the molar mass of non-molecular NaCl. It is more correct to call it the *formula mass*.

The percent composition of a compound is the mass of each element divided by the total mass of the compound x 100%. The percent composition can be determined from the formulas of the compound or experimentally by a decomposition reaction of the compound. In the activities suggested for this learning outcome, students are given either the percent composition or mass data and are required to determine the appropriate formula.

The problems that students are expected to solve with respect to the determination of formula from percent composition and mass data should be kept as simple as possible. Several examples follow.



## SPECIFIC LEARNING OUTCOME

**C11-3-11:** Determine empirical and molecular formulas from percent composition or mass data.

(continued)

## Sample Problems

1. If a compound has a composition of 40.0% carbon (C), 6.714% hydrogen (H), and 53.29% oxygen (O), determine the *empirical* formula of the compound.

Assume that there is a 100.0 g sample of the compound, in which case:

$$\text{C} \quad \frac{40.0 \text{ g}}{12.0 \text{ g/mol}} = 3.3 \text{ mol}$$

$$\text{H} \quad \frac{6.71 \text{ g}}{1.01 \text{ g/mol}} = 6.7 \text{ mol}$$

$$\text{O} \quad \frac{53.29 \text{ g}}{16.0 \text{ g/mol}} = 3.3 \text{ mol}$$

By dividing by the smallest number of moles, the ratio between the elements in the formula is  $\text{C}_1\text{H}_2\text{O}_1$ .

2. If a compound contains 71.65% chlorine (Cl), 24.27% carbon (C), and 4.07% hydrogen (H), determine the *molecular* formula if the molar mass is 98.96 g/mol.

Assume that there is a 100.0 g sample of the compound, in which case:

$$\text{Cl} \quad \frac{71.65 \text{ g}}{35.5 \text{ g/mol}} = 2.02 \text{ mol}$$

$$\text{C} \quad \frac{24.27 \text{ g}}{12.01 \text{ g/mol}} = 2.02 \text{ mol}$$

$$\text{H} \quad \frac{4.07 \text{ g}}{1.01 \text{ g/mol}} = 4.01 \text{ mol}$$

By dividing by the smallest number of moles, the ratio between the elements is  $\text{C}_1\text{H}_2\text{Cl}_1$ , and the formula mass would then be 49.5 g/mol.

If the molar mass is 98.96 g/mol, the molecular formula would be a multiple of the simplest formula, or

$$\frac{98.96 \text{ g/mol}}{49.5 \text{ g/mol}} = 2$$

The molecular formula is therefore  $\text{C}_2\text{H}_4\text{Cl}_2$ .

**SKILLS AND ATTITUDES OUTCOMES**

**C11-0-U1:** Use appropriate strategies and skills to develop an understanding of chemical concepts.

*Examples: analogies, concept frames, concept maps, manipulatives, particulate representations, role-plays, simulations, sort-and-predict frames, word cycles...*

**C11-0-U2:** Demonstrate an understanding of chemical concepts.

*Examples: use accurate scientific vocabulary, explain concepts to others, compare and contrast concepts, apply knowledge to new situations and/or contexts, create analogies, use manipulatives...*

**C11-0-S7:** Interpret patterns and trends in data, and infer and explain relationships.

3. Experimental analysis determined that a compound contained 7.30 g of sodium (Na), 5.08 g of sulphur (S), and 7.62 g of oxygen (O). What is the *simplest* formula of this compound?

$$\text{Na} \frac{7.30 \text{ g}}{23.0 \text{ g/mol}} = 0.317 \text{ mol}$$

$$\text{S} \frac{5.08 \text{ g}}{32.1 \text{ g/mol}} = 0.158 \text{ mol}$$

$$\text{O} \frac{7.62 \text{ g}}{16.90 \text{ g/mol}} = 0.476 \text{ mol}$$

By dividing by the smallest number of moles, the simplest formula becomes:

**SUGGESTIONS FOR ASSESSMENT****Laboratory Reports**

If students participate in lab activities, their work could be assessed as formal lab reports using the Laboratory Report Outline or the Laboratory Report Format (see *SYSTH* 11.38, 14.12) or by using questions and answers from the data collected from the activities.

**Paper-and-Pencil Tasks**

Students could be assessed on solving various problems that relate to formulas and either percent composition or mass data.





**SPECIFIC LEARNING OUTCOME**

**C11-3-11:** Determine empirical and molecular formulas from percent composition or mass data.

(continued)

---

**LEARNING RESOURCES LINKS**



*Chemistry* (Chang 89)

*Chemistry* (Zumdahl and Zumdahl 93)

*Chemistry: The Central Science* (Brown, et al. 84)

*Chemistry: Concepts and Applications* (Phillips, Strozak, and Wistrom 426)

*Glencoe Chemistry: Matter and Change* (Dingrando, et al. 328)

*Introductory Chemistry: A Foundation* (Zumdahl 226)

*McGraw-Hill Ryerson Chemistry, Combined Atlantic Edition* (Mustoe, et al. 78)

*McGraw-Hill Ryerson Chemistry 11, Ontario Edition* (Mustoe, et al. 207)

*Nelson Chemistry 12: College Preparation, Ontario Edition* (Davies, et al. 111)

*Prentice Hall Chemistry: Connections to Our Changing World* (LeMay, et al. 332)

**Investigations**

*Glencoe Chemistry: Matter and Change* (Dingrando, et al. 329 – percent composition of sweeteners)

*McGraw-Hill Ryerson Chemistry, Combined Atlantic Edition* (Mustoe, et al. 92 – determining the empirical formula of magnesium oxide, MgO)

*McGraw-Hill Ryerson Chemistry 11, Ontario Edition* (Mustoe, et al. 212 – determining the empirical formula of MgO)

*Nelson Chemistry 11, Ontario Edition* (Jenkins, et al. 195 – determining the formula of a hydrate)

*Nelson Chemistry 12: College Preparation, Ontario Edition* (Davies, et al. 121 – percent composition by mass of MgO)

**SKILLS AND ATTITUDES OUTCOMES**

**C11-0-U1:** Use appropriate strategies and skills to develop an understanding of chemical concepts.

*Examples: analogies, concept frames, concept maps, manipulatives, particulate representations, role-plays, simulations, sort-and-predict frames, word cycles...*

**C11-0-U2:** Demonstrate an understanding of chemical concepts.

*Examples: use accurate scientific vocabulary, explain concepts to others, compare and contrast concepts, apply knowledge to new situations and/or contexts, create analogies, use manipulatives...*

**C11-0-S7:** Interpret patterns and trends in data, and infer and explain relationships.

---

**NOTES**

**SPECIFIC LEARNING OUTCOMES**

**C11-3-12:** Interpret a balanced equation in terms of moles, mass, and volumes of gases.

(0.5 hour)

**C11-3-13:** Solve stoichiometric problems involving moles, mass, and volume, given the reactants and products in a balanced chemical reaction.

Include: heat of reaction problems

(3.5 hours)

SLO: C11-3-12  
SLO: C11-3-13

**SUGGESTIONS FOR INSTRUCTION****Entry-Level Knowledge**

A detailed discussion of the molar coefficients has not previously taken place. However, in Grade 10 Science, students wrote chemical reactions from word equations and balanced them for conservation of atoms (learning outcome S2-2-06). In Grade 11 Chemistry, students will likely have balanced reactions that contained polyatomic ions in the treatment of learning outcome C11-3-05.

**Assessing Prior Knowledge**

Check for student understanding of prior knowledge and review as necessary. Prior knowledge can be reviewed and/or assessed by using any of the KWL strategies (e.g., Concept Map, Knowledge Chart, Think-Pair-Share – see *SYSTH*, Chapter 9).

**TEACHER NOTES**

Show students the various ways in which a balanced chemical equation or reaction can be interpreted. Emphasize that the *mole* is the central unit in understanding the relationship between reactants and products in a chemical reaction – that is, the balanced reaction coefficients can represent moles, molecules, conservation of mass in grams, or amu, or volumes of gas. See *Chemistry: The Molecular Nature of Matter and Change* (Silberberg 105).

**General Learning Outcome Connections**

- GLO A1:** Recognize both the power and limitations of science as a way of answering questions about the world and explaining natural phenomena.
- GLO A2:** Recognize that scientific knowledge is based on evidence, models, and explanations, and evolves as new evidence appears and new conceptualizations develop.
- GLO A4:** Identify and appreciate contributions made by women and men from many societies and cultural backgrounds that have increased our understanding of the world and brought about technological innovations.
- GLO D3:** Understand the properties and structures of matter, as well as various common manifestations and applications of the actions and interactions of matter.
- GLO E1:** Describe and appreciate the similarity and diversity of forms, functions, and patterns within the natural and constructed world.

**SKILLS AND ATTITUDES OUTCOMES**

**C11-0-U1:** Use appropriate strategies and skills to develop an understanding of chemical concepts.

*Examples: analogies, concept frames, concept maps, manipulatives, particulate representations, role-plays, simulations, sort-and-predict frames, word cycles...*

**C11-0-U2:** Demonstrate an understanding of chemical concepts.

*Examples: use accurate scientific vocabulary, explain concepts to others, compare and contrast concepts, apply knowledge to new situations and/or contexts, create analogies, use manipulatives...*

**C11-0-S7:** Interpret patterns and trends in data, and infer and explain relationships.

---

Since students have previously written and balanced chemical reaction equations involving polyatomic ions (learning outcome C11-3-05), teachers could now introduce an extension to stoichiometry using polyatomic species.

**Historical Connection**

Jeremias Benjamin Richter (1762–1807) introduced *stoichiometry* in 1792. He is credited with stating, “stoichiometry is the science of measuring the quantitative proportions or mass ratios in which chemical elements stand to one another.”

**Sample Problems**

1. At first, provide students with very simple questions regarding the use of coefficients, and then have them work through a series of more complex examples. A suggested progression follows:

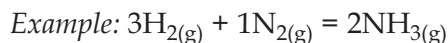

*Sample Questions (with notes):*

- a) First, work through multiples of molar coefficients.  
How many moles of ammonia would be produced from the reaction of 6 mol of  $\text{H}_{2(\text{g})}$  and 2 mol of  $\text{N}_{2(\text{g})}$ ?
- b) Then:  
How many moles of  $\text{N}_{2(\text{g})}$  would be required to react exactly with 9 mol of  $\text{H}_{2(\text{g})}$ ?
- c) Followed by:  
How many moles of hydrogen and nitrogen gases would be required to produce 0.4 mol of ammonia?

Through this progression, students have an opportunity to work with coefficients before working with mass and volume. (However, the molar coefficients also represent volumes of gas.)

**SPECIFIC LEARNING OUTCOMES**

**C11-3-12:** Interpret a balanced equation in terms of moles, mass, and volumes of gases.

**C11-3-13:** Solve stoichiometric problems involving moles, mass, and volume, given the reactants and products in a balanced chemical reaction.

Include: heat of reaction problems

(continued)

2. Once students can manipulate the coefficients to solve mole problems, start with one reactant that is given as mass.

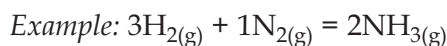

*Question:* Calculate the number of moles of ammonia produced with 12.0 g of hydrogen gas and an unlimited amount of nitrogen.

*Solution:* Since 12.0 g is 6.0 mol, which means the mole ratio is doubled, there must be 4.0 mol of ammonia produced.

3. There are almost as many ways of solving *mass-to-mass stoichiometry problems* as there are chemistry teachers.

One such progression is provided here as an example. Standard chemistry texts also provide additional methods. Most texts provide their own “unique” method of setting up these calculations. Teachers should fit the solution format to the learning style and ability of their students.

A recommendation is to use mass amounts that give moles that can be solved visually with the mole ratio of the balanced reaction.

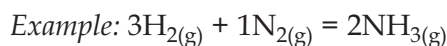

*Question:* Calculate the mass of ammonia produced from 1.2 g of hydrogen reacting with an excess of nitrogen.

*Solution:* 1.2 g of hydrogen = 0.60 mol

Have students place the moles of hydrogen over the molar coefficient for hydrogen. As the amount of nitrogen is unlimited, the amount of product is dependent on the amount of hydrogen, and so we can ignore nitrogen from the mole ratio.

$$\frac{0.60}{3\text{H}_{2(g)}} + \frac{\text{unlimited}}{1\text{N}_{2(g)}} = \frac{\text{X}}{2\text{NH}_{3(g)}}$$

The mole ratio is

$$\frac{0.60}{3} = \frac{\text{X}}{2}$$

$$\text{X} = 0.40 \text{ mol of NH}_3 \text{ or } 6.8 \text{ g of product}$$

**SKILLS AND ATTITUDES OUTCOMES**

**C11-0-U1:** Use appropriate strategies and skills to develop an understanding of chemical concepts.

*Examples: analogies, concept frames, concept maps, manipulatives, particulate representations, role-plays, simulations, sort-and-predict frames, word cycles...*

**C11-0-U2:** Demonstrate an understanding of chemical concepts.

*Examples: use accurate scientific vocabulary, explain concepts to others, compare and contrast concepts, apply knowledge to new situations and/or contexts, create analogies, use manipulatives...*

**C11-0-S7:** Interpret patterns and trends in data, and infer and explain relationships.

4. Once students have mastered mass-to-mass problems, introduce the *heat of reaction*.

*Question:* What quantity of heat is produced in the complete combustion of 60.16 g of ethane,  $C_2H_6$ , if the heat of combustion is 1560 kJ/mol of ethane?

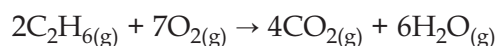

*Solution:*

$$60.16 \text{ g } C_2H_6 \times \frac{1 \text{ mol } C_2H_6}{30.08 \text{ g } C_2H_6} \times \frac{1560 \text{ kJ}}{1 \text{ mol } C_2H_6} = 3120 \text{ kJ}$$

**Laboratory Activities**

The following lab activities could be used to reinforce the concept of stoichiometry.

- Stoichiometry of a Reaction Producing a Precipitate:** This microscale experiment requires students to react solid iron with copper(II) sulphate. The full lab procedure can be found in Experiment 14 in *Microscale Chemistry Laboratory Manual* (Slater and Rayner-Canham 39).
- Stoichiometry: Concept Extension:** This lab involves reacting solutions of varying concentrations in order to develop the stoichiometric proportions between sodium hypochlorite, NaOCl, and sodium thiosulphate,  $Na_2S_2O_3$ .

This lab activity could also be used when addressing specific learning outcomes dealing with the notion of *limiting reagents*.

**SUGGESTIONS FOR ASSESSMENT****Laboratory Reports**

The activities suggested for these learning outcomes could be assessed as formal lab reports using the Laboratory Report Outline or the Laboratory Report Format (see SYSTH 11.38, 14.12) or by using questions and answers from the data collected from the activities.

**Written Test/Quiz**

Students could interpret various stoichiometric word problems in which they balance chemical equations and determine quantities of reactants and products.



#### SPECIFIC LEARNING OUTCOMES

**C11-3-12:** Interpret a balanced equation in terms of moles, mass, and volumes of gases.

**C11-3-13:** Solve stoichiometric problems involving moles, mass, and volume, given the reactants and products in a balanced chemical reaction.

Include: heat of reaction problems

(continued)

---



#### Internet Research

Based on their knowledge of stoichiometry and their research on gasoline and the size of gas tank and fuel economy of specified vehicles, students calculate the following:

- the cost of filling a tank of gas
- the number of moles of gasoline in a full tank of gas
- the mass of a full tank of gas
- the distance travelled on a full tank
- the amount of carbon dioxide,  $\text{CO}_2$ , emitted when a full tank is consumed

See Appendix 3.12: The Stoichiometry of Gasoline: Internet Research Activity.

#### Visual Displays

Use concept-mapping software to create a concept map indicating the various quantitative relationships among terms such as mole, mass, volume, reactants, products, and chemical equation.

#### Peer Assessment

Students construct stoichiometry problems that could be used for peer assessment.

### SKILLS AND ATTITUDES OUTCOMES

**C11-0-U1:** Use appropriate strategies and skills to develop an understanding of chemical concepts.

*Examples: analogies, concept frames, concept maps, manipulatives, particulate representations, role-plays, simulations, sort-and-predict frames, word cycles...*

**C11-0-U2:** Demonstrate an understanding of chemical concepts.

*Examples: use accurate scientific vocabulary, explain concepts to others, compare and contrast concepts, apply knowledge to new situations and/or contexts, create analogies, use manipulatives...*

**C11-0-S7:** Interpret patterns and trends in data, and infer and explain relationships.

---

### LEARNING RESOURCES LINKS

---



*Chemistry* (Chang 95)

*Chemistry* (Zumdahl and Zumdahl 108)

*Chemistry: The Central Science* (Brown, et al. 95)

*Chemistry: Concepts and Applications* (Phillips, Strozak, and Wistrom 404)

*Chemistry: The Molecular Nature of Matter and Change* (Silberberg 105)

*Glencoe Chemistry: Matter and Change* (Dingrando, et al. 354)

*Introductory Chemistry: A Foundation* (Zumdahl 255)

*McGraw-Hill Ryerson Chemistry, Combined Atlantic Edition* (Mustoe, et al. 119)

*McGraw-Hill Ryerson Chemistry 11, Ontario Edition* (Mustoe, et al. 235)

*Microscale Chemistry Laboratory Manual* (Slater and Rayner-Canham 39)

*Nelson Chemistry 12: College Preparation, Ontario Edition* (Davies, et al. 144)

*Prentice Hall Chemistry: Connections to Our Changing World* (LeMay, et al. 347)



**SPECIFIC LEARNING OUTCOME**

**C11-3-14:** Identify the limiting reactant and calculate the mass of a product, given the reaction equation and reactant data.

**(3.0 hours)**

SLO: C11-3-14

**SUGGESTIONS FOR INSTRUCTION**
**Entry-Level Knowledge**

Specific chemistry examples involving limiting factors (such as amounts of reagent) have not been addressed before Grade 11, although teachers have likely cited many examples in day-to-day living where the product has been limited by what was available.

**TEACHER NOTES**

In learning outcome C11-3-13, students were introduced to the idea that a reactant could be available in excess or even unlimited in amount. A class discussion could then lead students to conclude that, where more than one reactant is involved, the reactant that is *not in excess* would *limit* the amount of product and that some of the excess reactant would be left over and admixed with the product.

To reinforce this concept, students need to appreciate practical, real-life examples of limiting factors, such as the key ingredients required to bake a cake (e.g., sodium bicarbonate), or the parts required to manufacture a car that functions. If one of the ingredients (or parts) is *missing*, the final product cannot be produced. For instance, as the missing ingredient or part would determine whether the process could be completed at all, the concept of a *limiting factor* can become apparent to students.

Students should begin by solving *limiting reagent* type of problems that are confined to mole-mole calculations. Emphasize the need to balance the equation first so as to obtain the correct mole ratios. As students gain confidence, mass and volume calculations should be incorporated into the problems. By the time learning outcome C11-3-14 has been demonstrated, students should be able to calculate the quantity of excess reagent that does not react and account for its presence among the products of a reaction.

**General Learning Outcome Connections**

- GLO C4:** Demonstrate appropriate critical thinking and decision-making skills when choosing a course of action based on scientific and technological information.
- GLO C6:** Employ effective communication skills and use information technology to gather and share scientific and technological ideas and data.
- GLO C7:** Work cooperatively and value the ideas and contributions of others while carrying out scientific and technological activities.
- GLO D3:** Understand the properties and structures of matter, as well as various common manifestations and applications of the actions and interactions of matter.

**SKILLS AND ATTITUDES OUTCOMES**

**C11-0-U1:** Use appropriate strategies and skills to develop an understanding of chemical concepts.

*Examples: analogies, concept frames, concept maps, manipulatives, particulate representations, role-plays, simulations, sort-and-predict frames, word cycles...*

**C11-0-U2:** Demonstrate an understanding of chemical concepts.

*Examples: use accurate scientific vocabulary, explain concepts to others, compare and contrast concepts, apply knowledge to new situations and/or contexts, create analogies, use manipulatives...*

**C11-0-S1:** Demonstrate work habits that ensure personal safety and the safety of others, as well as consideration for the environment.

Include: knowledge and use of relevant safety precautions, Workplace Hazardous Materials Information System (WHMIS), emergency equipment

**C11-0-S3:** Design and implement an investigation to answer a specific scientific question.

Include: materials, independent and dependent variables, controls, methods, safety considerations

**C11-0-S5:** Collect, record, organize, and display data using an appropriate format.

*Examples: labelled diagrams, graphs, multimedia applications, software integration, probeware...*

**C11-0-S7:** Interpret patterns and trends in data, and infer and explain relationships.

**C11-0-S9:** Draw a conclusion based on the analysis and interpretation of data.

Include: cause-and-effect relationships, alternative explanations, supporting or rejecting a hypothesis or prediction

Emphasize that the limiting reactant is not necessarily the reactant with the smallest mass or volume. Explain to students that they must calculate the number of moles of product formed from the number of moles of each reactant in order to identify the limiting reactant. For a solution strategy, consult learning resources for typical problem-solving techniques involving limiting reagent situations. In doing these problems, students readily see the powerful use of the mole concept. (For a solution strategy, see Appendix 3.13: How to Solve a Limiting Reactant Problem.)

**Demonstration**

The burning of magnesium can be used to introduce students to limiting reactants.

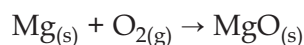

When all the magnesium is burned, the reaction ceases. Therefore, magnesium is the limiting reactant because it dictates the quantity of product formed. Oxygen gas is the excess reactant because it is still present when the reaction ceases.

**Laboratory Activities**

Students could do simple labs to reinforce the *limiting factor* concept experimentally.

1. Cut four or five pieces of magnesium ribbon of different sizes. Do a pre-lab test to determine the correct amount of magnesium and concentration of hydrochloric acid required to inflate a balloon. The amount and concentration of the acid would be constant, whereas the amount of magnesium would vary. Have students place the pieces of magnesium into pre-stretched balloons that are similar in size. Attach the balloons to an Erlenmeyer flask to which an appropriate amount of acid has been added. Once the balloons are fitted, the balloon can be tipped to allow the magnesium strip to fall into the acid. As the magnesium is the limiting factor, the balloons will inflate to different amounts to

**SPECIFIC LEARNING OUTCOME**

**C11-3-14:** Identify the limiting reactant and calculate the mass of a product, given the reaction equation and reactant data.

(continued)

illustrate that the acid is excess and the magnesium is limiting. It is possible to calculate the stoichiometric volume of hydrogen gas expected using Boyle's Law and knowing the atmospheric pressure in the room. The gas volume could be collected by water displacement if the apparatus was modified with a delivery tube. See *Prentice Hall Chemistry: Connections to Our Changing World* (LeMay, et al. 366).

- This activity could also be done by adding differing amounts of effervescent antacid tablets to water and collecting the gas that is produced.

References to more formal student experiments can be found in the Learning Resources Links.

**STSE Issue**

Automobiles use the energy produced during the combustion of gasoline. The combustion of gasoline usually produces water and carbon dioxide. Gasoline is a complex mixture of many organic compounds; however, the following reaction is considered to be representative of a general reaction.

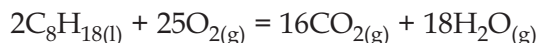

If the quantity of oxygen is limited in the reaction, however, the pollutant carbon monoxide is produced instead. Students could calculate the volume of  $\text{CO}_{2(g)}$  emission from 1 L of gasoline as the limiting factor and oxygen as an unlimited reactant, assuming the conditions to be STP.

Have students then calculate the amount of  $\text{CO}_{2(g)}$  for their own family automobile or other means of transport for a day, a week, and over the average life expectancy of the vehicle.

A discussion of the merits and shortcomings of the scientific community's research agenda into the anthropogenic  $\text{CO}_2$  contribution to potential global warming could be conducted in relation to this topic. It should be noted that there is significantly polarized debate on the issue among scientists. Students should be justifiably cautious about accepting unsubstantiated claims about global warming. This issue provides an opportunity to engage students in the patterns of behaviour that occur within science during what can be termed a "crisis" situation. The word "crisis" in this context is that of philosopher and historian of science, Thomas S. Kuhn, and comes from his influential writing *The Structure of Scientific Revolutions*.

**SKILLS AND ATTITUDES OUTCOMES**

**C11-0-U1:** Use appropriate strategies and skills to develop an understanding of chemical concepts.

*Examples: analogies, concept frames, concept maps, manipulatives, particulate representations, role-plays, simulations, sort-and-predict frames, word cycles...*

**C11-0-U2:** Demonstrate an understanding of chemical concepts.

*Examples: use accurate scientific vocabulary, explain concepts to others, compare and contrast concepts, apply knowledge to new situations and/or contexts, create analogies, use manipulatives...*

**C11-0-S1:** Demonstrate work habits that ensure personal safety and the safety of others, as well as consideration for the environment.

Include: knowledge and use of relevant safety precautions, Workplace Hazardous Materials Information System (WHMIS), emergency equipment

**C11-0-S3:** Design and implement an investigation to answer a specific scientific question.

Include: materials, independent and dependent variables, controls, methods, safety considerations

**C11-0-S5:** Collect, record, organize, and display data using an appropriate format.

*Examples: labelled diagrams, graphs, multimedia applications, software integration, probeware...*

**C11-0-S7:** Interpret patterns and trends in data, and infer and explain relationships.

**C11-0-S9:** Draw a conclusion based on the analysis and interpretation of data.

Include: cause-and-effect relationships, alternative explanations, supporting or rejecting a hypothesis or prediction

**RAFT Activity**

Students complete a RAFT activity in which they describe their role in a reaction on behalf of a limiting reactant or an excess reactant. (See *SYSTH* 13.23-13.28.)

**SUGGESTIONS FOR ASSESSMENT****Paper-and-Pencil Tasks: Written Test/Quiz**

Students solve problems involving a limiting reactant.

**Journal Writing**

1. Students create an analogy to represent a limiting reactant problem.

*Example:* If a sundae requires 2 scoops of ice cream, 1 cherry, and 50 mL of chocolate syrup, how many sundaes can be made with 8 scoops of ice cream, 6 cherries, and 100 mL of chocolate syrup?

2. Students could also identify how limiting reactants influence their everyday lives.

*Example:* The barbeque stops functioning when it runs out of propane.

3. Journal writing could be connected to an STSE issue.

**Problem Construction**

Students construct their own limiting reactant problems, including a solution.

**SPECIFIC LEARNING OUTCOME**

**C11-3-14:** Identify the limiting reactant and calculate the mass of a product, given the reaction equation and reactant data.

(continued)

---

**Research Reports**

Have students, individually or in small groups, present their examples for limiting factor situations. The information collected could be presented as

- written reports
- oral presentations
- bulletin board displays
- multimedia presentations

Each of these presentation styles could be assessed using an appropriate rubric created with students prior to the assignment. Samples of presentation rubrics are provided in Appendix 10 of this document.

**Laboratory Reports**

The activities suggested for this learning outcome could be assessed as formal lab reports using the Laboratory Report Format (see *SYSTH* 14.12) or by using questions and answers from the data collected from the activities.

**LEARNING RESOURCES LINKS**

---



*Chemistry* (Chang 99)

*Chemistry* (Zumdahl and Zumdahl 113)

*Chemistry: The Central Science* (Brown, *et al.* 99)

*Chemistry: Concepts and Applications* (Phillips, Strozak, and Wistrom 220)

*Chemistry: The Molecular Nature of Matter and Change* (Silberberg 111)

*Glencoe Chemistry: Matter and Change* (Dingrando, *et al.* 364)

*Glencoe Chemistry: Matter and Change: Laboratory Manual – Teacher Edition* (89 – limiting reactant investigation with magnesium metal and varying amounts of hydrochloric acid)

*Introductory Chemistry: A Foundation* (Zumdahl 197 – treatment of the combustion of fuels, 259)

*McGraw-Hill Ryerson Chemistry, Combined Atlantic Edition* (Mustoe, *et al.* 112 – limiting reactant investigation with sodium hydrogen carbonate and hydrochloric acid, 129)

*McGraw-Hill Ryerson Chemistry 11, Ontario Edition* (Mustoe, *et al.* 252, 255 – limiting reactant investigation with aluminum metal and copper(II) chloride)

**SKILLS AND ATTITUDES OUTCOMES**

**C11-0-U1:** Use appropriate strategies and skills to develop an understanding of chemical concepts.

*Examples: analogies, concept frames, concept maps, manipulatives, particulate representations, role-plays, simulations, sort-and-predict frames, word cycles...*

**C11-0-U2:** Demonstrate an understanding of chemical concepts.

*Examples: use accurate scientific vocabulary, explain concepts to others, compare and contrast concepts, apply knowledge to new situations and/or contexts, create analogies, use manipulatives...*

**C11-0-S1:** Demonstrate work habits that ensure personal safety and the safety of others, as well as consideration for the environment.

Include: knowledge and use of relevant safety precautions, Workplace Hazardous Materials Information System (WHMIS), emergency equipment

**C11-0-S3:** Design and implement an investigation to answer a specific scientific question.

Include: materials, independent and dependent variables, controls, methods, safety considerations

**C11-0-S5:** Collect, record, organize, and display data using an appropriate format.

*Examples: labelled diagrams, graphs, multimedia applications, software integration, probeware...*

**C11-0-S7:** Interpret patterns and trends in data, and infer and explain relationships.

**C11-0-S9:** Draw a conclusion based on the analysis and interpretation of data.

Include: cause-and-effect relationships, alternative explanations, supporting or rejecting a hypothesis or prediction

---

*Nelson Chemistry 11, Ontario Edition (Jenkins, et al. 230, 232—limiting reactant investigation with calcium nitrate and sodium phosphate)*

*Nelson Chemistry 12: College Preparation, Ontario Edition (Davies, et al. 149)*

*Prentice Hall Chemistry: Connections to Our Changing World (LeMay, et al. 366)*

Most learning resources provide simple activities or analogies that illustrate the concept of limiting reactants. Choosing which activity to complete as a class lab or as a teacher demonstration will ultimately be determined by what materials are available and how much time is on hand.

**SPECIFIC LEARNING OUTCOME**

**C11-3-15:** Perform a lab involving mass-mass or mass-volume relations, identifying the limiting reactant and calculating the mole ratio.

Include: theoretical yield, experimental yield

(2.0 hours)

SLO: C11-3-15

**SUGGESTIONS FOR INSTRUCTION****Entry-Level Knowledge**

Students have previously studied gases, including the relationship between pressure and temperature.

**TEACHER NOTES**

Students will perform labs involving a limiting reactant. Provide students with the necessary background on the techniques that may be required to perform the labs, such as filtration and the use of gas-collecting tubes.

**Laboratory Activities**

Have students perform a lab to investigate the stoichiometric relationship between reactants and products. Many experiments can be done to illustrate this concept. A number of suggestions follow; however, the details for these experiments would have to be obtained from lab manuals. Additional references for student investigations are available in the Learning Resources Links listed for this learning outcome.

1. A classic lab example is the reaction of an excess of copper with a limiting solution of silver nitrate.

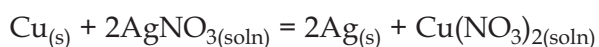

This investigation gives excellent results and can be extended to include the conservation of mass by using additional procedures and reactions. (See Appendix 3.14: The Behaviour of Solid Copper Immersed in a Water Solution of the Compound Silver Nitrate.)

**General Learning Outcome Connections**

- GLO C1:** Recognize safety symbols and practices related to scientific and technological activities and to their daily lives, and apply this knowledge in appropriate situations.
- GLO C2:** Demonstrate appropriate scientific inquiry skills when seeking answers to questions.
- GLO C3:** Demonstrate appropriate problem-solving skills when seeking solutions to technological challenges.
- GLO C4:** Demonstrate appropriate critical thinking and decision-making skills when choosing a course of action based on scientific and technological information.
- GLO C6:** Employ effective communication skills and use information technology to gather and share scientific and technological ideas and data.
- GLO C7:** Work cooperatively and value the ideas and contributions of others while carrying out scientific and technological activities.

## SKILLS AND ATTITUDES OUTCOMES

**C11-0-S1:** Demonstrate work habits that ensure personal safety and the safety of others, as well as consideration for the environment.

Include: knowledge and use of relevant safety precautions, Workplace Hazardous Materials Information System (WHMIS), emergency equipment

**C11-0-S3:** Design and implement an investigation to answer a specific scientific question.

Include: materials, independent and dependent variables, controls, methods, safety considerations

**C11-0-S5:** Collect, record, organize, and display data using an appropriate format.

Examples: labelled diagrams, graphs, multimedia applications, software integration, probeware...

**C11-0-S9:** Draw a conclusion based on the analysis and interpretation of data.

Include: cause-and-effect relationships, alternative explanations, supporting or rejecting a hypothesis or prediction

2. Another example is the single replacement reactions of

- copper(II) sulphate pentahydrate and steel wool



Or

- aluminum and copper(II) chloride dehydrate

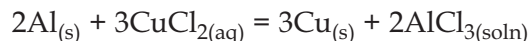

3. A further example is the reaction of magnesium ribbon with an excess of hydrochloric acid.

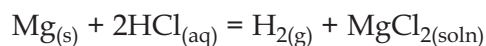

The hydrogen gas produced would be collected by the displacement of water in a eudiometer tube. In this lab, students convert the experimental volume of gas at room temperature to the volume occupied at STP conditions. (Dalton's Law of partial pressures was not discussed in the treatment of gas laws. So the partial pressure from water vapour would have to be neglected. Fortunately, the contribution from water vapour is not large.) Students calculate the theoretical yield from the mass of magnesium and the reaction and compare it to the experimental value. (See Appendix 3.15: A Quantitative Investigation of the Reaction of a Metal with Hydrochloric Acid.)

4. If teachers have access to probeware, they may choose to do a lab procedure using probes, electronic data collection, and a plotting software interface to represent the data. (See Appendix 3.16: Stoichiometry: Reactants, Products, and Enthalpy Changes.)



**SPECIFIC LEARNING OUTCOME**

**C11-3-15:** Perform a lab involving mass-mass or mass-volume relations, identifying the limiting reactant and calculating the mole ratio.

Include: theoretical yield, experimental yield

(continued)

---

**SUGGESTIONS FOR ASSESSMENT**

---

**Laboratory Reports**

The experiments suggested for this learning outcome could be assessed as formal lab reports using the Laboratory Report Format (see *SYSTH* 14.12) or by using questions and answers from the data collected from the activities.

For each of the experiments, students determine the predicted and experimental yields. They then use these values to calculate the percent yield. Encourage students to identify and explain sources of experimental error.

**Student Activity**

Have students design an experimental lab that could be used to illustrate quantitatively the concept of a *limiting reactant*. A sample student-designed experiment can be found in most standard chemistry resources for students.

**Rubrics/Checklists**

See Appendix 10 for a variety of rubrics and checklists that can be used for self-assessment, peer assessment, and teacher assessment of lab skills and lab reports.

**Paper-and-Pencil Tasks**

Students could solve problems that involve one of the reactants being excess.

## SKILLS AND ATTITUDES OUTCOMES

**C11-0-S1:** Demonstrate work habits that ensure personal safety and the safety of others, as well as consideration for the environment.

Include: knowledge and use of relevant safety precautions, Workplace Hazardous Materials Information System (WHMIS), emergency equipment

**C11-0-S3:** Design and implement an investigation to answer a specific scientific question.

Include: materials, independent and dependent variables, controls, methods, safety considerations

**C11-0-S5:** Collect, record, organize, and display data using an appropriate format.

Examples: labelled diagrams, graphs, multimedia applications, software integration, probeware...

**C11-0-S9:** Draw a conclusion based on the analysis and interpretation of data.

Include: cause-and-effect relationships, alternative explanations, supporting or rejecting a hypothesis or prediction

## LEARNING RESOURCES LINKS



*Glencoe Chemistry: Matter and Change* (Dingrando, et al. 374— reaction of Fe with  $\text{CuSO}_4 \cdot 5\text{H}_2\text{O}$ )

*McGraw-Hill Ryerson Chemistry, Combined Atlantic Edition* (Mustoe, et al. 112— reaction of HCl and  $\text{NaHCO}_3$ )

*McGraw-Hill Ryerson Chemistry 11, Ontario Edition* (Mustoe, et al. 235— reaction of HCl and  $\text{NaHCO}_3$ )

*Microscale Chemistry Laboratory Manual* (Slater and Rayner-Canham, Experiment 14: reaction of Fe with  $\text{CuSO}_4 \cdot 5\text{H}_2\text{O}$ , Experiment 15: reaction of  $\text{NaHCO}_3$  and  $\text{H}_2\text{SO}_4$ )

*Nelson Chemistry 11, Ontario Edition* (Jenkins, et al. 227— reaction of zinc and lead(II) nitrate)

*Nelson Chemistry 12: College Preparation, Ontario Edition* (Davies, et al. 154— reaction of strontium chloride and copper(II) sulphate)

*Prentice Hall Chemistry: Connections to Our Changing World* (LeMay, et al. 374— reaction of Fe with  $\text{CuSO}_4 \cdot 5\text{H}_2\text{O}$ )

**SPECIFIC LEARNING OUTCOME**

**C11-3-16:** Discuss the importance of stoichiometry in industry and describe specific applications.

*Examples: analytical chemistry, chemical engineering, industrial chemistry...*

(2.5 hours)

SLO: C11-3-16

**SUGGESTIONS FOR INSTRUCTION****Entry-Level Knowledge**

Students have not previously studied the concepts in this learning outcome.

**TEACHER NOTES**

Students are not expected to study the examples identified in this learning outcome in great detail. The examples simply serve as an indicator of the importance of stoichiometry in our lives. Teachers are encouraged to use local examples of the application of stoichiometry, wherever possible. Examples could include: air bags, ammonia production, breath analysis, fertilizers, metallurgy, rocket fuels, and so on. Some information is provided below.

Teachers can have students collect background information from their own chemistry textbooks or do additional research using print and online resources. Some teacher resources referenced in the Learning Resources Links also provide related information.



Many online sources connect stoichiometry principles to applications. For example, see the links at the following website.

Chemistry Coach: <<http://www.chemistrycoach.com/tutorial.htm#tutorials>>

The online resources listed below can provide teachers with some initial guidance in identifying common industrial applications of classical stoichiometry. These examples are by no means exhaustive.

**Applications of Stoichiometry: Examples**

- **Air-Bag Technology (Gas Chemistry)**

The following reaction illustrates the explosive production of nitrogen gas from sodium azide to inflate automobile air bags:

**General Learning Outcome Connections**

**GLO A5:** Recognize that science and technology interact with and advance one another.

**GLO B4:** Demonstrate knowledge of and personal consideration for a range of possible science- and technology-related interests, hobbies, and careers.



**SPECIFIC LEARNING OUTCOME**

**C11-3-16:** Discuss the importance of stoichiometry in industry and describe specific applications.

*Examples: analytical chemistry, chemical engineering, industrial chemistry...*

(continued)

- **Industrial Use**

Hydrogen sulphide gas is often used in the manufacture of cellophane.

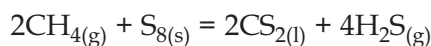

Wood pulp (cellulose fibre) is dissolved in sodium hydroxide and treated with  $\text{H}_2\text{S}$  gas to form viscose, an intermediate in the formation of rayon and cellophane.

Potash and quicklime are used in the manufacture of soap.

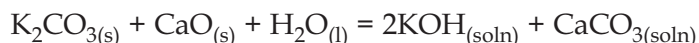

- **Metallurgical Use**

Due to its light weight and strength, titanium is a transition metal used in the manufacture of many alloys.

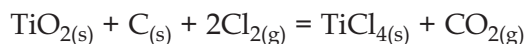

- **Chemical Engineering**

Solid rocket fuel is a mixture of 12% aluminum powder and 74% ammonium perchlorate. Once ignited, the reaction *cannot* be stopped!

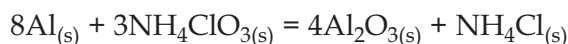
**SUGGESTIONS FOR ASSESSMENT**
**Class Discussion**

To validate stoichiometry as a topic not only for the chemistry classroom, have students provide examples of industrial applications.

**Research/Reports**

Have students research and report on one or more applications of stoichiometry. Results could be shared in written, verbal, or electronic format. If students are to use the Internet for research, provide them with key search words to reduce search time. Many of the texts listed in the Learning Resources Links contain information on some examples identified in the learning outcome.

**SKILLS AND ATTITUDES OUTCOMES**

- C11-0-R1:** Synthesize information obtained from a variety of sources.  
Include: print and electronic sources, specialists, other resource people
- C11-0-R2:** Evaluate information obtained to determine its usefulness for information needs.  
*Examples: scientific accuracy, reliability, currency, relevance, balance of perspectives, bias...*
- C11-0-R3:** Quote from or refer to sources as required and reference information sources according to an accepted practice.
- C11-0-R5:** Communicate information in a variety of forms appropriate to the audience, purpose, and context.
- 

**Research Report Presentations**

Based on their research, students describe how stoichiometry is used in industry. Information may be shared with the entire class through Jigsaw activities (see *SYSTH* 3.19, 3.20) or through formal presentations to the entire class.

**Visual Display**

Students create a visual display, such as a poster, to demonstrate an application of stoichiometry (e.g., a poster that highlights an industrial application of stoichiometry).

**Collaborative Teamwork**

Instructional strategies, such as Jigsaw or Roundtable, could be used to have students share knowledge of specific applications of stoichiometry with classmates. (See *SYSTH* 3.19, 3.20.)

**Community Connections**

Conduct a field trip to a local industry that uses stoichiometry.

**Journal Writing**

Students reflect on an industrial application of stoichiometry. Their reflection could be based on how industrial stoichiometry influences their everyday lives or on careers that use stoichiometry.

**Rubrics/Checklists**

See Appendix 10 for rubrics and checklists that can be used for self-assessment, peer assessment, and teacher assessment for any of the research presentations, either visual or written.



### SPECIFIC LEARNING OUTCOME

**C11-3-16:** Discuss the importance of stoichiometry in industry and describe specific applications.

*Examples: analytical chemistry, chemical engineering, industrial chemistry...*

(continued)

---

### LEARNING RESOURCES LINKS

---



*Chemistry* (Chang 95)

*Chemistry* (Zumdahl and Zumdahl 108)

*Chemistry: The Central Science* (Brown, et al. 95)

*Chemistry: Concepts and Applications* (Phillips, Strozak, and Wistrom 404)

*Chemistry: The Molecular Nature of Matter and Change* (Silberberg 105)

*Glencoe Chemistry: Matter and Change* (Dingrando, et al. 354)

*Introductory Chemistry: A Foundation* (Zumdahl 255)

*McGraw-Hill Ryerson Chemistry, Combined Atlantic Edition* (Mustoe, et al. 110)

*McGraw-Hill Ryerson Chemistry 11, Ontario Edition* (Mustoe, et al. 235)

*Microscale Chemistry Laboratory Manual* (Slater and Rayner-Canham, Experiments 14 and 15)

*Nelson Chemistry 12: College Preparation, Ontario Edition* (Davies, et al. 144)

*Prentice Hall Chemistry: Connections to Our Changing World* (LeMay, et al. 347)

**SKILLS AND ATTITUDES OUTCOMES**

**C11-0-R1:** Synthesize information obtained from a variety of sources.

Include: print and electronic sources, specialists, other resource people

**C11-0-R2:** Evaluate information obtained to determine its usefulness for information needs.

*Examples: scientific accuracy, reliability, currency, relevance, balance of perspectives, bias...*

**C11-0-R3:** Quote from or refer to sources as required and reference information sources according to an accepted practice.

**C11-0-R5:** Communicate information in a variety of forms appropriate to the audience, purpose, and context.

---

**NOTES**





# TOPIC 4: SOLUTIONS

---





## Topic 4: Solutions

- C11-4-01** Describe and give examples of various types of solutions.  
Include: all nine possible types
- C11-4-02** Describe the structure of water in terms of electronegativity and the polarity of its chemical bonds.
- C11-4-03** Explain the solution process of simple ionic and covalent compounds, using visual, particulate representations and chemical equations.  
Include: crystal structure, dissociation, hydration
- C11-4-04** Explain heat of solution with reference to specific applications.  
*Examples: cold packs, hot packs...*
- C11-4-05** Perform a lab to illustrate the formation of solutions in terms of the polar and non-polar nature of substances.  
Include: soluble, insoluble, miscible, immiscible
- C11-4-06** Construct, from experimental data, a solubility curve of a pure substance in water.
- C11-4-07** Differentiate among saturated, unsaturated, and supersaturated solutions.
- C11-4-08** Use a graph of solubility data to solve problems.
- C11-4-09** Explain how a change in temperature affects the solubility of gases.
- C11-4-10** Explain how a change in pressure affects the solubility of gases.
- C11-4-11** Perform a lab to demonstrate freezing-point depression and boiling-point elevation.
- C11-4-12** Explain freezing-point depression and boiling-point elevation at the molecular level.  
*Examples: antifreeze, road salt...*
- C11-4-13** Differentiate among, and give examples of, the use of various representations of concentration.  
Include: grams per litre (g/L), % weight-weight (% w/w), % weight-volume (% w/v), % volume/volume (% v/v), parts per million (ppm), parts per billion (ppb), moles per litre (mol/L) (molarity)
- C11-4-14** Solve problems involving calculation for concentration, moles, mass, and volume.
- C11-4-15** Prepare a solution, given the amount of solute (in grams) and the volume of solution (in millilitres), and determine the concentration in moles/litre.
- C11-4-16** Solve problems involving the dilution of solutions.  
Include: dilution of stock solutions, mixing common solutions with different volumes and concentrations
- C11-4-17** Perform a dilution from a solution of known concentration.
- C11-4-18** Describe examples of situations where solutions of known concentration are important.  
*Examples: pharmaceutical preparations, administration of drugs, aquaria, swimming-pool disinfectants, gas mixes for scuba, radiator antifreeze...*
- C11-4-19** Describe the process of treating a water supply, identifying the allowable concentrations of metallic and organic species in water suitable for consumption.

**Suggested Time: 18.0 hours**



**SPECIFIC LEARNING OUTCOME****C11-4-01:** Describe and give examples of various types of solutions.

Include: all nine possible types

(1.0 hour)

SLO: C11-4-01

**SUGGESTIONS FOR INSTRUCTION****Entry-Level Knowledge**

In Grade 7 Science, students investigated the characteristics of, and relationships among, solutions and mixtures, including

- differentiating between pure substances and mixtures and solutions versus mechanical mixtures (learning outcomes 7-2-13 and 7-2-14)
- demonstrating separation techniques for solutions (e.g. evaporation and introductory filtration) and mechanical mixtures (learning outcome 7-2-18)

Grade 7 Science included a discussion of the characteristics of solutions, with examples from daily life, and a discussion of solutions in terms of the particle theory of matter.

**Assessing Prior Knowledge**

Check for student understanding of prior knowledge and review as necessary. Prior knowledge can be reviewed and/or assessed by using any of the KWL strategies (e.g., Concept Map, Knowledge Chart, Think-Pair-Share—see *SYSTH*, Chapter 9).

**Demonstration/Discrepant Event**

A demonstration that is often called “the impossible transfer trick” is an effective way to introduce the topic of solutions. Prepare about 50 mL of a supersaturated solution of sodium acetate, NaAc, in a new 100 mL Erlenmeyer flask. If an older, dirty flask is used, the solution will likely precipitate prematurely. If it does precipitate, the solution can be gently warmed in a hot water bath to redissolve the NaAc. Once the nearly hot solution is saturated, allow the solution to cool slowly to room temperature. Wipe the mouth of the flask carefully with a damp towel to remove any traces of NaAc. Place a similar 100 mL flask with an equal volume of water in it next to the NaAc flask. Ask students whether it is possible for them to pour all the water into a 25 mL beaker. Have a student try it, with obvious results. Now claim that students can do it without spilling a drop. Use a clean beaker, but

**General Learning Outcome Connections**

- GLO C8:** Evaluate, from a scientific perspective, information and ideas encountered during investigations and in daily life.
- GLO D3:** Understand the properties and structures of matter, as well as various common manifestations and applications of the actions and interactions of matter.
- GLO D5:** Understand the composition of the Earth’s atmosphere, hydrosphere, and lithosphere, as well as the processes involved within and among them.

**SKILLS AND ATTITUDES OUTCOMES**

**C11-0-U1:** Use appropriate strategies and skills to develop an understanding of chemical concepts.

*Examples: analogies, concept frames, concept maps, manipulatives, particulate representations, role-plays, simulations, sort-and-predict frames, word cycles...*

**C11-0-R1:** Synthesize information obtained from a variety of sources.

Include: print and electronic sources, specialists, other resource people

with a small crystal seed placed at the bottom. The crystal solid that results will form a tall column in the beaker if poured slowly. The column is fragile.

**TEACHER NOTES**

Most chemical reactions occur in an aqueous medium, and not in the solid, liquid, or gaseous phase. Students should be familiar with the nine types of solutions presented below and should be able to provide an example for each. Emphasize that the smaller amount in a solution is usually classified as the *solute* and the larger amount the *solvent*. Ask students to provide examples other than those presented below.

Types of Solutions	
Solution	Example
solid in solid	<ul style="list-style-type: none"> <li>copper in silver (sterling silver)</li> <li>zinc in copper (brass)</li> </ul>
solid in liquid	<ul style="list-style-type: none"> <li>salt in water (ocean water)</li> <li>iodine in alcohol (tincture)</li> </ul>
solid in gas	<ul style="list-style-type: none"> <li>microscopic particulates in air</li> <li>mothball particles in air</li> </ul>
liquid in solid	<ul style="list-style-type: none"> <li>mercury in silver amalgams (tooth fillings)*</li> </ul>
liquid in liquid	<ul style="list-style-type: none"> <li>ethylene glycol in water (engine antifreeze)</li> <li>methanol in water (gas line antifreeze)</li> </ul>
liquid in gas	<ul style="list-style-type: none"> <li>water vapour in air</li> </ul>
gas in solid	<ul style="list-style-type: none"> <li>hydrogen in palladium** (purification of hydrogen)</li> <li>poisonous gases <i>adsorbed</i> in carbon (charcoal filter)</li> </ul>
gas in liquid	<ul style="list-style-type: none"> <li>carbon dioxide in beverages (carbonated beverages)</li> <li>oxygen in water (supporting aquatic life)</li> </ul>
gas in gas	<ul style="list-style-type: none"> <li>oxygen in nitrogen (air)</li> </ul>

\* Have students ask their dentists to explain the use of a known carcinogen in an amalgam for oral/dental use.

\*\* At room temperature, palladium will absorb 900 times its own volume of hydrogen.

**Journal Writing**

Have students relate the demonstration/ discrepant event in their journals. Students could also include their dentists' explanation of the use of a known carcinogen in an amalgam for oral/ dental use (as a follow-up).

**SPECIFIC LEARNING OUTCOME****C11-4-01:** Describe and give examples of various types of solutions.

Include: all nine possible types

*(continued)***SUGGESTIONS FOR ASSESSMENT**

---

**Visual Display**

Students could create a visual display in their notebooks or on poster paper to represent the nine types of solutions and examples. Have them indicate where the examples could be found in their daily lives. They could also bring examples of solutions from home.

**Research Reports**

Have students brainstorm additional examples of solutions. Students could research the examples and report their findings either individually or in small groups. The information collected could be presented as

- written reports
- oral presentations
- bulletin board displays

Each of these presentation styles could be assessed using an appropriate rubric created with students prior to the assignment. Samples of presentation rubrics are provided in Appendix 10 of this document.

**Rubrics/Checklists**

See Appendix 10 for a variety of rubrics and checklists that can be used for self-assessment, peer assessment, and teacher assessment.

**Paper-and-Pencil Tasks: Written Test/Quiz**

Students demonstrate an understanding of the types of solutions and provide alternate examples.

**LEARNING RESOURCES LINKS**

---

*Chemistry* (Chang 488)*Glencoe Chemistry: Matter and Change* (Dingrando, et al. 454)*McGraw-Hill Ryerson Chemistry, Combined Atlantic Edition* (Mustoe, et al. 238)*McGraw-Hill Ryerson Chemistry 11, Ontario Edition* (Mustoe, et al. 285)*Nelson Chemistry 11, Ontario Edition* (Jenkins, et al. 266)*Prentice Hall Chemistry: Connections to Our Changing World* (LeMay, et al. 503)

**SKILLS AND ATTITUDES OUTCOMES**

**C11-0-U1:** Use appropriate strategies and skills to develop an understanding of chemical concepts.

*Examples: analogies, concept frames, concept maps, manipulatives, particulate representations, role-plays, simulations, sort-and-predict frames, word cycles...*

**C11-0-R1:** Synthesize information obtained from a variety of sources.

Include: print and electronic sources, specialists, other resource people

---

**NOTES**



**SPECIFIC LEARNING OUTCOME**

**C11-4-02:** Describe the structure of water in terms of electronegativity and the polarity of its chemical bonds.

(0.5 hour)

SLO: C11-4-02

**SUGGESTIONS FOR INSTRUCTION****Entry-Level Knowledge**

In Grade 10 Science, students constructed Bohr or Electron (Lewis) Dot models of a variety of compounds containing ionic and covalent compounds. The Bohr models were constructed up to and including atomic number 18 (argon). Examples may also have included ammonia, methane, and water. (See *Senior 1 Science: A Foundation for Implementation* Appendix 2.6, 2.7, and *Senior 2 Science: A Foundation for Implementation*, Appendix 2.1.)

**TEACHER NOTES**

Introducing the concept of *electronegativity* at this point will enable teachers to explain the solution process more clearly in the next learning outcome (C11-4-03), which deals specifically with the polarity of the water molecule as it relates to the solution process. A detailed explanation of *polar covalent bonding* is not expected at this time. This extension will be discussed in Grade 12 Chemistry.

**Demonstration**

Introduce polarity with a demonstration illustrating that a stream of water can be bent by either a magnetic or an electric force. For example, use of a burette and a source of static electricity works well. The stronger the electrostatic force used, the thinner the stream will be and the more dramatic the effect will be. Use this demonstration to generate class discussion about the shape of the water molecule and its polarity. Most student learning resources will include this as a teacher demonstration. Much discussion should follow. Encourage students to justify their speculations based on their own emerging models of electrostatics that began with Grade 3 Science and were last addressed in Grade 9 Science.

The demonstration also leads to the concept of *electronegativity*, which is a measure of the ability of an atom in a chemical bond to attract electrons. In the case of the water molecule, the oxygen atom is more electronegative than hydrogen is. As a result, the electrons in the chemical bonds orient themselves more completely around the oxygen atom. This makes the hydrogen more positive and the oxygen more negative. This results in polar bonds and a polar molecule.

**General Learning Outcome Connections**

**GLO D3:** Understand the properties and structures of matter, as well as various common manifestations and applications of the actions and interactions of matter.

**SKILLS AND ATTITUDES OUTCOMES**

**C11-0-U1:** Use appropriate strategies and skills to develop an understanding of chemical concepts.

*Examples: analogies, concept frames, concept maps, manipulatives, particulate representations, role-plays, simulations, sort-and-predict frames, word cycles...*

**C11-0-R1:** Synthesize information obtained from a variety of sources.

Include: print and electronic sources, specialists, other resource people

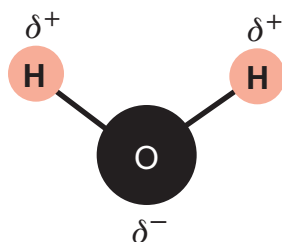

**Polar Water Molecule**

Show students a periodic table with electronegativity values to explain the polarity of the atoms in the water molecule.

The demonstration could be done either by two students or by the whole class if enough equipment is available. Static electricity equipment would most likely be found in the school lab facility. Some faucets in chemistry labs (e.g., those with narrowed spouts) can produce streams thin enough that the whole class could (and should) get involved in the demonstration.



## SUGGESTIONS FOR ASSESSMENT

Assessment for understanding of electronegativity and the polarity of chemical bonds will occur later when students are expected to explain the solution process.

### Rubrics/Checklists

See Appendix 10 for a variety of rubrics and checklists that can be used for self-assessment, peer assessment, and teacher assessment.

### Visual Displays

Students could represent the diagram of a polar water molecule using

- posters
- models
- multimedia

Each of these presentation styles could be assessed using an appropriate rubric created with students prior to the assignment. Samples of presentation rubrics are provided in Appendix 10 of this document.



**SPECIFIC LEARNING OUTCOME**

**C11-4-02:** Describe the structure of water in terms of electronegativity and the polarity of its chemical bonds.

(continued)

---

**Journal Writing**

Students may want to describe the demonstration and its significance in their journals.

**Paper-and-Pencil Tasks**

Students should be able to explain why a molecule such as water is polar, based on the electronegativity of a similar molecule such as H<sub>2</sub>S.

---

**LEARNING RESOURCES LINKS**



*Chemistry* (Chang 357)

*Chemistry* (Zumdahl and Zumdahl 352)

*Chemistry: The Central Science* (Brown, et al. 285)

*Chemistry: Concepts and Applications* (Phillips, Strozak, and Wistrom 303, 311)

*Chemistry: The Molecular Nature of Matter and Change* (Silberberg 134)

*Glencoe Chemistry: Matter and Change* (Dingrando, et al. 168, 263)

*Introductory Chemistry: A Foundation* (Zumdahl 319)

*McGraw-Hill Ryerson Chemistry, Combined Atlantic Edition* (Mustoe, et al. 176, 245)

*McGraw-Hill Ryerson Chemistry 11, Ontario Edition* (Mustoe, et al. 86, 91)

*Nelson Chemistry 11, Ontario Edition* (Jenkins, et al. 274)

*Nelson Chemistry 12, Ontario Edition* (van Kessel, et al. 252)

*Nelson Chemistry 12: College Preparation, Ontario Edition* (Davies, et al. 200, 272)

*Prentice Hall Chemistry: Connections to Our Changing World* (LeMay, et al. 184, 261, 514)

Most of the resources listed here are quite complex and move quickly into molecular geometry.

**SKILLS AND ATTITUDES OUTCOMES**

**C11-0-U1:** Use appropriate strategies and skills to develop an understanding of chemical concepts.

*Examples: analogies, concept frames, concept maps, manipulatives, particulate representations, role-plays, simulations, sort-and-predict frames, word cycles...*

**C11-0-R1:** Synthesize information obtained from a variety of sources.

Include: print and electronic sources, specialists, other resource people

---

**NOTES**

**SPECIFIC LEARNING OUTCOME**

**C11-4-03:** Explain the solution process of simple ionic and covalent compounds, using visual, particulate representations and chemical equations.

Include: crystal structure, dissociation, hydration

(1.0 hour)

SLO: C11-4-03

**SUGGESTIONS FOR INSTRUCTION****Entry-Level Knowledge**

In Grade 10 Science (learning outcome S2-2-02), students explained, through use of the periodic table, how and why elements combine in specific ratios to form ionic and covalent compounds. They also constructed Bohr and Electron Dot models of these types of compounds and learned how to name and write their formulas.

In Grade 11 Chemistry (learning outcome C11-1-03), students were introduced to crystals and crystal lattice structures. They were also asked to draw diagrams of crystals.

**Assessing Prior Knowledge**

Check for student understanding of prior knowledge and review as necessary. Prior knowledge can be reviewed and/or assessed by using any of the KWL strategies (e.g., Concept Map, Knowledge Chart, Think-Pair-Share—see *SYSTH*, Chapter 9).

**TEACHER NOTES**

Teachers may want to combine learning outcome C11-4-03 with the next learning outcome (C11-4-04), which addresses *heat of solution*.

**The Solvation Process**

A sodium chloride crystal, NaCl, will be used in the following explanation of the solvation process with students. Encourage students to explain the phenomena involved using other examples once they understand the behaviour of NaCl.

A detailed explanation of the solvation process is complex and is beyond the scope of Grade 11 Chemistry. There are many intermolecular forces that interact: solvent-solvent, solute-solute, and solute-solvent particles. Depending on the characteristics of the solute and the solvent, each of these interactions may be either exothermic or endothermic. Another factor involved in the “mix” is that of *randomness*. According

**General Learning Outcome Connections**

- GLO A1:** Recognize both the power and limitations of science as a way of answering questions about the world and explaining natural phenomena.
- GLO A2:** Recognize that scientific knowledge is based on evidence, models, and explanations, and evolves as new evidence appears and new conceptualizations develop.
- GLO D3:** Understand the properties and structures of matter, as well as various common manifestations and applications of the actions and interactions of matter.

## SKILLS AND ATTITUDES OUTCOMES

**C11-0-U1:** Use appropriate strategies and skills to develop an understanding of chemical concepts.

Examples: analogies, concept frames, concept maps, manipulatives, particulate representations, role-plays, simulations, sort-and-predict frames, word cycles...

**C11-0-R1:** Synthesize information obtained from a variety of sources.

Include: print and electronic sources, specialists, other resource people

to thermodynamic principles, matter tends to become more random. As a result of the interaction of these factors, the solubility of a solute can vary significantly with each solvent. The saying that “like dissolves like” is helpful in predicting the solubility of a substance in a given solvent. What this means is that two substances with similar polarity are most likely to be mutually soluble. If a solute and solvent are mutually soluble in all proportions they are both said to be *miscible*.

Students are aware (from learning outcome C11-4-02) that water molecules are polar and have a partial positive charge around the hydrogen atoms and a partial negative charge around the oxygen atom.

When a solute is placed into a solvent, the solvent particles completely surround the surface of the solute particles. As shown in the diagram below, for the case of water and NaCl, the polar water molecules orientate themselves around each exposed ion on the crystal surface (lattice) of the solid. The positive end of the water molecule orientates itself toward the negative chloride ion  $\text{Cl}^-$  and the negative end of the water molecule toward the positive sodium ion  $\text{Na}^+$ .

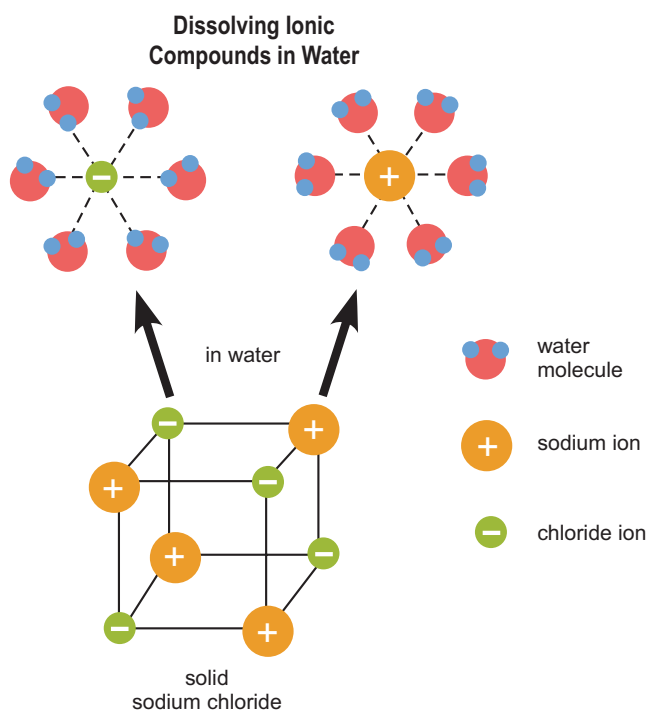



## SPECIFIC LEARNING OUTCOME

**C11-4-03:** Explain the solution process of simple ionic and covalent compounds, using visual, particulate representations and chemical equations.

Include: crystal structure, dissociation, hydration

(continued)

An electrostatic competition occurs between the water molecules and the forces of attraction within the solute crystal. If the solute is soluble, the attraction between the solvent molecules and the solute ions gradually increases to the point where it finally exceeds the forces holding the ions into the crystal lattice. As a result, the solute ions are pulled into the solvent and become completely surrounded by the solvent molecules. (The diagram below demonstrates the concept of *solvation*).

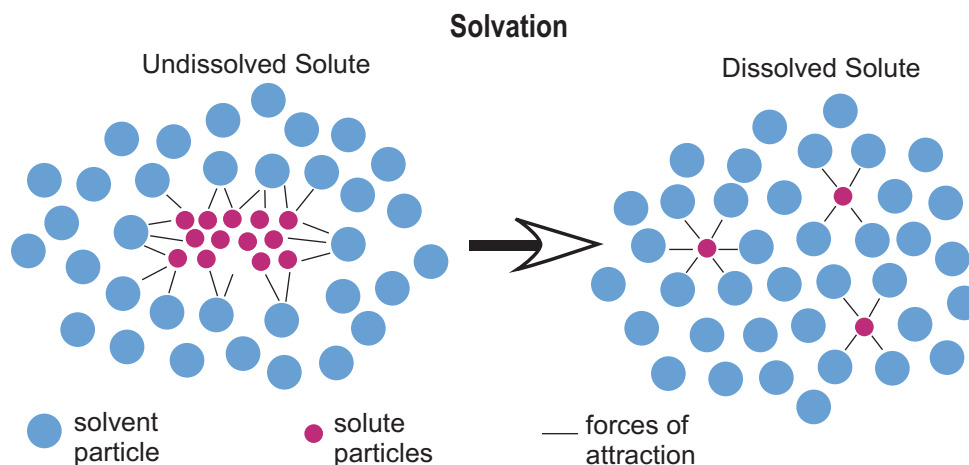

The separation of ions is called *dissociation*, whereas the process of surrounding the solute particles with solvent particles is called *solvation*. If the solvent is water, this process is called *hydration*. The solute particles are said to be hydrated.

### Covalent Solvation

Students need to be aware that an entire molecule is pulled away from the solid structure in a covalent solid as it goes into solution.

### Chemical Equations

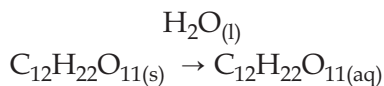
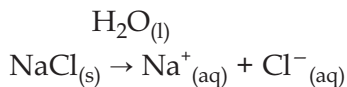

**SKILLS AND ATTITUDES OUTCOMES**

**C11-0-U1:** Use appropriate strategies and skills to develop an understanding of chemical concepts.

*Examples: analogies, concept frames, concept maps, manipulatives, particulate representations, role-plays, simulations, sort-and-predict frames, word cycles...*

**C11-0-R1:** Synthesize information obtained from a variety of sources.

Include: print and electronic sources, specialists, other resource people

---

**Extension**

A number of properties are associated with water of hydration.

- *Decrepitation* is the process by which the water of hydration that is mechanically bound to the crystal lattice is vigorously released from some crystals when heated (e.g., lead nitrate).
- *Efflorescence* is the process by which loosely held water of hydration is lost when the crystals are exposed to the air (e.g.,  $\text{Na}_2\text{CO}_3 \cdot 10\text{H}_2\text{O}$ ).

**SUGGESTIONS FOR ASSESSMENT**

---

**Rubrics/Checklists**

See Appendix 10 for a variety of rubrics and checklists that can be used for self-assessment, peer assessment, and teacher assessment.

**Visual Displays**

Students could represent what they have learned using

- posters
- pamphlets
- bulletin board displays
- models

Each of the visual displays could be assessed using an appropriate rubric created with students prior to the assignment. Samples of presentation rubrics are provided in Appendix 10 of this document.





**SPECIFIC LEARNING OUTCOME**

**C11-4-03:** Explain the solution process of simple ionic and covalent compounds, using visual, particulate representations and chemical equations.

Include: crystal structure, dissociation, hydration

(continued)

**Paper-and-Pencil Tasks**

1. Students should be able to use diagrams, such as the one that follows involving the *molecular compound* crystalline sugar, to explain the solvation process of either an ionic or a molecular solid dissolved in water.

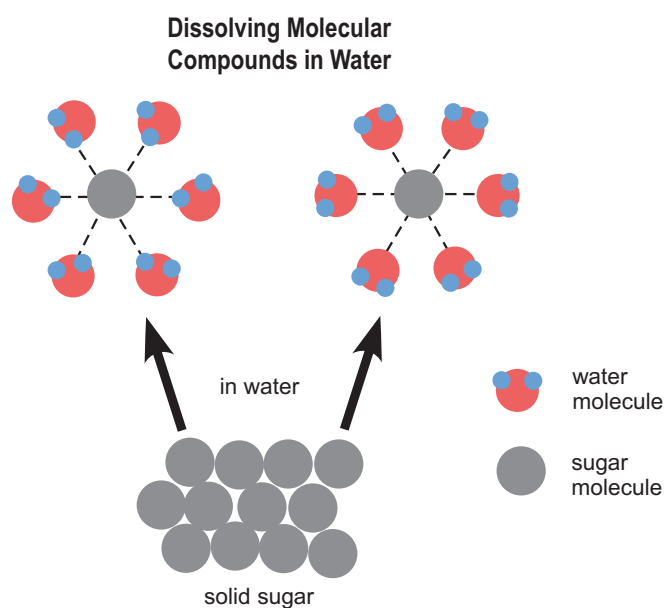

2. Use a Knowledge Chart to summarize the solution process for ionic compounds. (See SYSTH 9.8–9.9, 9.24–9.25.)
3. Students could create a song, skit, poem, comic strip, or pantomime to illustrate the solution process.

### SKILLS AND ATTITUDES OUTCOMES

**C11-0-U1:** Use appropriate strategies and skills to develop an understanding of chemical concepts.

*Examples: analogies, concept frames, concept maps, manipulatives, particulate representations, role-plays, simulations, sort-and-predict frames, word cycles...*

**C11-0-R1:** Synthesize information obtained from a variety of sources.

Include: print and electronic sources, specialists, other resource people

---

### LEARNING RESOURCES LINKS

---



*Chemistry* (Chang 117, 489)

*Chemistry: The Central Science* (Brown, et al. 487)

*Chemistry: Concepts and Applications* (Phillips, Strozak, and Wistrom 452)

*Chemistry: The Molecular Nature of Matter and Change* (Silberberg 135)

*Glencoe Chemistry: Matter and Change* (Dingrando, et al. 455)

*Introductory Chemistry: A Foundation* (Zumdahl 424)

*McGraw-Hill Ryerson Chemistry, Combined Atlantic Edition* (Mustoe, et al. 246)

*McGraw-Hill Ryerson Chemistry 11, Ontario Edition* (Mustoe, et al. 239)

*Nelson Chemistry 12: College Preparation, Ontario Edition* (Davies, et al. 273)

*Prentice Hall Chemistry: Connections to Our Changing World* (LeMay, et al. 512)



## SPECIFIC LEARNING OUTCOME

**C11-4-04:** Explain heat of solution with reference to specific applications.

*Examples: cold packs, hot packs...*

(0.5 hour)

SLO: C11-4-04

## SUGGESTIONS FOR INSTRUCTION

## Entry-Level Knowledge

In Grade 7 Science (learning outcomes 7-2-16 to 7-2-20), students explored some properties of solutions. Although they investigated the solution process, they did not discuss the difference between exothermic and endothermic dissolving reactions. There was, however, some introductory treatment of the differences between *temperature* and *heat* (learning outcome 7-2-07).

## Assessing Prior Knowledge

Check for student understanding of prior knowledge and review as necessary. Prior knowledge can be reviewed and/or assessed by using any of the KWL strategies (e.g., Concept Map, Knowledge Chart, Think-Pair-Share—see *SYSTH*, Chapter 9).

## TEACHER NOTES

Teachers will most likely treat learning outcomes C11-4-04 and C11-4-03 together.

When attractive forces are broken, energy is required. Therefore, the separation of solute particles from one another and the separation of solvent particles from one another are both endothermic processes. The attraction between solute and solvent particles during the solvation process is exothermic. Whether energy is absorbed or released in the overall net process of solution formation depends on the balance between these two processes. The net energy change is called the *heat of solution*.

If the amount of energy absorbed is greater than the amount of energy released, then the overall solution becomes *endothermic*.

*Example:*  $\text{NH}_4\text{NO}_3(\text{s}) + \text{heat} = \text{NH}_4^+(\text{aq}) + \text{NO}_3^-(\text{aq})$

## General Learning Outcome Connections

- GLO A5:** Recognize that science and technology interact with and advance one another.
- GLO B4:** Demonstrate knowledge of and personal consideration for a range of possible science- and technology-related interests, hobbies, and careers.
- GLO D3:** Understand the properties and structures of matter, as well as various common manifestations and applications of the actions and interactions of matter.
- GLO E4:** Recognize that energy, whether transmitted or transformed, is the driving force of both movement and change, and is inherent within materials and in the interactions among them.

**SKILLS AND ATTITUDES OUTCOMES**

**C11-0-U1:** Use appropriate strategies and skills to develop an understanding of chemical concepts.

*Examples: analogies, concept frames, concept maps, manipulatives, particulate representations, role-plays, simulations, sort-and-predict frames, word cycles...*

**C11-0-U2:** Demonstrate an understanding of chemical concepts.

*Examples: use accurate scientific vocabulary, explain concepts to others, compare and contrast concepts, apply knowledge to new situations and/or contexts, create analogies, use manipulatives...*

If the amount of energy absorbed is less than the amount of energy released, then the overall solution becomes *exothermic*.

*Example:*  $\text{CaCl}_{2(s)} = \text{Ca}_{2}^{+}(\text{aq}) + 2\text{Cl}^{-}(\text{aq}) + \text{heat}$

**Demonstration**

Teachers are reminded to select an activity, demonstration, or lab investigation that is appropriate for students and for the science facility available.

1. Add a small amount of calcium chloride,  $\text{CaCl}_2$ , and ammonium nitrate,  $\text{NH}_4\text{NO}_3$ , to separate test tubes. Half fill each test tube with water at room temperature. Then, with gentle agitation, observe the temperature change for each, as felt through the glass wall of the test tube (these changes are detectable but do not present risk factors). Ammonium nitrate is *endothermic* when it dissolves in water, whereas calcium chloride is *exothermic*. These are the usual substances found in cold and hot packs respectively.
2. This demonstration requires some preparation but it is well worth the effort. You can solidly freeze a beaker to a 40 cm<sup>2</sup> sheet of ¼ inch (0.5 cm) plywood!
  - First, spray about 5 mL of water onto the centre of the plywood. This can be done before students enter the room.
  - With the plywood on a table, place the 400 mL beaker on the puddle of water. Add 20 g of barium hydroxide,  $\text{Ba}(\text{OH})_2 \cdot 8\text{H}_2\text{O}$ , and then 10 g of ammonium thiocyanate,  $\text{NH}_4\text{SCN}$ .
  - Mix with a long stirring rod for about two minutes until the mixture starts to become liquefied.
  - Try to lift the beaker. It will be frozen to the plywood.

**Caution:** Ammonia is produced as a product and so a well-ventilated area is required. The beaker should be placed in the fume hood once the demonstration is finished. Other compounds will also produce an endothermic reaction, and are referenced in the Learning Resources Links.



#### SPECIFIC LEARNING OUTCOME

**C11-4-04:** Explain heat of solution with reference to specific applications.

*Examples: cold packs, hot packs...*

*(continued)*

---



#### SUGGESTIONS FOR ASSESSMENT

---

##### Laboratory/Demonstration Reports

The lab activities suggested for this learning outcome could be assessed as formal lab reports using the Laboratory Report Outline or the Laboratory Report Format (see *SYSTH* 11.38, 14.12) or by using questions and answers from the data collected from the activities.

##### Journal Writing

If the plywood demonstration is done, students may want to elaborate on it in their journals.

##### Paper-and-Pencil Tasks

Students should be able to explain the interaction of particles on a molecular level and explain how the interaction is related to the absorption or release of energy.

#### LEARNING RESOURCES LINKS

---



*Chemistry* (Chang 489)

*Chemistry* (Zumdahl and Zumdahl 515)

*Chemistry: The Central Science* (Brown, et al. 487)

*Chemistry: The Molecular Nature of Matter and Change* (Silberberg 494)

*Glencoe Chemistry: Matter and Change* (Dingrando, et al. 457)

*McGraw-Hill Ryerson Chemistry 11, Ontario Edition* (Mustoe, et al. 291)

**SKILLS AND ATTITUDES OUTCOMES**

**C11-0-U1:** Use appropriate strategies and skills to develop an understanding of chemical concepts.

*Examples: analogies, concept frames, concept maps, manipulatives, particulate representations, role-plays, simulations, sort-and-predict frames, word cycles...*

**C11-0-U2:** Demonstrate an understanding of chemical concepts.

*Examples: use accurate scientific vocabulary, explain concepts to others, compare and contrast concepts, apply knowledge to new situations and/or contexts, create analogies, use manipulatives...*

---

**NOTES**

**SPECIFIC LEARNING OUTCOME**

**C11-4-05:** Perform a lab to illustrate the formation of solutions in terms of the polar and non-polar nature of substances.

Include: soluble, insoluble, miscible, immiscible

(1.5 hours)

SLO: C11-4-05

**SUGGESTIONS FOR INSTRUCTION****Entry-Level Knowledge**

The definition of solubility and the factors affecting solubility are introduced in Grade 7 Science in the form of an experiment (learning outcome 7-2-20 included terms such as agitation, surface area, particle size, and temperature). However, the concept of polar and non-polar molecules is new to students at this level.

**Assessing Prior Knowledge**

Check for student understanding of prior knowledge and review as necessary. Prior knowledge can be reviewed and/or assessed by using any of the KWL strategies (e.g., Concept Map, Knowledge Chart, Think-Pair-Share—see *SYSTH*, Chapter 9).

**TEACHER NOTES**

Most chemistry texts provide information and activities that discuss the terms *soluble*, *insoluble*, *miscible*, and *immiscible*.

Several demonstrations and lab activities are suggested for this learning outcome. As an alternative to informing students that “like dissolves like,” students could do a lab in which they discover this for themselves.

**Laboratory Activity**

Have students do a lab activity to discover the relationship between polar and non-polar substances. See Appendix 4.1: Polar and Non-Polar Substances.

Students mix each of the following substances with every other substance: copper(II) sulphate ( $\text{CuSO}_4$ ), water, vinegar, iodine, vegetable oil, and kerosene. Related terms (e.g., soluble, insoluble, miscible, immiscible) will be operationally defined through discovery during the lab.

**General Learning Outcome Connections**

- GLO A2:** Recognize that scientific knowledge is based on evidence, models, and explanations, and evolves as new evidence appears and new conceptualizations develop.
- GLO C1:** Recognize safety symbols and practices related to scientific and technological activities and to their daily lives, and apply this knowledge in appropriate situations.
- GLO C2:** Demonstrate appropriate scientific inquiry skills when seeking answers to questions.
- GLO C6:** Employ effective communication skills and use information technology to gather and share scientific and technological ideas and data.
- GLO D3:** Understand the properties and structures of matter, as well as various common manifestations and applications of the actions and interactions of matter.

**SKILLS AND ATTITUDES OUTCOMES**

**C11-0-S1:** Demonstrate work habits that ensure personal safety and the safety of others, as well as consideration for the environment.

Include: knowledge and use of relevant safety precautions, Workplace Hazardous Materials Information System (WHMIS), emergency equipment

**C11-0-S4:** Select and use scientific equipment appropriately and safely.

Examples: volumetric glassware, balance, thermometer...

**C11-0-S5:** Collect, record, organize, and display data using an appropriate format.

Examples: labelled diagrams, graphs, multimedia applications, software integration, probeware...

**Demonstrations**

Select the demonstration that best suits the class and available equipment. With supervision, students could easily complete demonstrations such as the following.

- 1. Water and Oil:** Use demonstrations to help students develop an understanding of the molecular interactions between polar and non-polar molecules. For overhead-transparency demonstrations that simulate the mixing of like and unlike molecules of solute and solvent, see Appendix 4.2: Why Don't Water and Oil Mix?
- 2. The "Polar" Disk:** Use a soft pencil to shade a piece of paper as densely as possible. Use a standard hole puncher to make approximately 20 disks from this paper. Add 100 mL of trichlorotrifluoroethane (TTE) to a 250 mL flask, together with an equal volume of water. Place the small paper disks into the flask containing the two liquids. Securely stopper the flask and shake. When the flask is shaken, the disks always orient themselves with the black side down.
- 3. Immiscible Liquids:** The following solution illustrates immiscible liquids. Half fill a 1 L clear plastic bottle with water, followed by 50 mL of ethanol. Then fill the bottle to the top with paint thinner. Add a few drops of blue food colouring and cap the bottle. Slowly rock the bottle and watch the immiscible fluids form waves.

**SUGGESTIONS FOR ASSESSMENT****Demonstration/Laboratory Reports**

The activities suggested for this learning outcome could be assessed as formal lab reports using the Laboratory Report Outline or the Laboratory Report Format (see *SYSTH* 11.38, 14.12) or by using questions and answers from the data collected from the activities.

**Journal Writing**

Students may wish to describe interesting applications to the demonstrations in their journals.

**Rubrics/Checklists**

See Appendix 10 for a variety of rubrics and checklists that can be used for self-assessment, peer assessment, and teacher assessment.





### SPECIFIC LEARNING OUTCOME

**C11-4-05:** Perform a lab to illustrate the formation of solutions in terms of the polar and non-polar nature of substances.

Include: soluble, insoluble, miscible, immiscible

(continued)

---

### Paper-and-Pencil Tasks

Students are expected to explain the difference between polar and non-polar substances.

### LEARNING RESOURCES LINKS

---



*Chemistry: Concepts and Applications* (Phillips, Strozak, and Wistrom 330)

*Glencoe Chemistry: Matter and Change* (Dingrando, et al. 264, 454)

*McGraw-Hill Ryerson Chemistry, Combined Atlantic Edition* (Mustoe, et al. 244)

*McGraw-Hill Ryerson Chemistry 11, Ontario Edition* (Mustoe, et al. 292)

*Nelson Chemistry 11, Ontario Edition* (Jenkins, et al. 274—Investigation 6.2.1)

*Prentice Hall Chemistry: Connections to Our Changing World* (LeMay, et al. 514, 515)

The references given here are for polar, non-polar, miscible, and immiscible substances.

**SKILLS AND ATTITUDES OUTCOMES**

**C11-0-S1:** Demonstrate work habits that ensure personal safety and the safety of others, as well as consideration for the environment.

Include: knowledge and use of relevant safety precautions, Workplace Hazardous Materials Information System (WHMIS), emergency equipment

**C11-0-S4:** Select and use scientific equipment appropriately and safely.

*Examples: volumetric glassware, balance, thermometer...*

**C11-0-S5:** Collect, record, organize, and display data using an appropriate format.

*Examples: labelled diagrams, graphs, multimedia applications, software integration, probeware...*

---

**NOTES**



## SPECIFIC LEARNING OUTCOME

**C11-4-06:** Construct, from experimental data, a solubility curve of a pure substance in water.

(1.0 hour)

SLO: C11-4-06

## SUGGESTIONS FOR INSTRUCTION

**Entry-Level Knowledge**

In Grade 7 Science (learning outcome 7-2-22), students were introduced to the terms *saturated* and *unsaturated*. During the discussion, students will have been introduced to the concept that temperature affects the amount of solid that can be dissolved in a given solvent.

In Grade 11 Chemistry (learning outcome C11-4-04), students were introduced to the *heat of solution* concept, and were informed that the solution process could be either exothermic or endothermic, depending on the solute and the solvent.

**Assessing Prior Knowledge**

Check for student understanding of prior knowledge and review as necessary. Prior knowledge can be reviewed and/or assessed by using any of the KWL strategies (e.g., Concept Map, Knowledge Chart, Think-Pair-Share—see *SYSTH*, Chapter 9).

**TEACHER NOTES**

Point out to students that, for certain solids, the amount of solid that dissolves at a given temperature actually decreases as the temperature increases.

Some chemistry resources (e.g., Mustoe, *et al.* 301) show a solubility graph that illustrates this counterintuitive reversal or “anomaly”; that is, for some solids, solubility decreases as temperature increases. A sample solubility graph that includes cerium sulphate,  $\text{Ce}_2(\text{SO}_4)_3$ , follows.

**General Learning Outcome Connections**

- GLO A2:** Recognize that scientific knowledge is based on evidence, models, and explanations, and evolves as new evidence appears and new conceptualizations develop.
- GLO C8:** Evaluate, from a scientific perspective, information and ideas encountered during investigations and in daily life.
- GLO D3:** Understand the properties and structures of matter, as well as various common manifestations and applications of the actions and interactions of matter.

## SKILLS AND ATTITUDES OUTCOMES

**C11-0-S7:** Interpret patterns and trends in data, and infer and explain relationships.

**C11-0-S8:** Evaluate data and data-collection methods for accuracy and precision.

Include: discrepancies in data, sources of error, percent error

**C11-0-S9:** Draw a conclusion based on the analysis and interpretation of data.

Include: cause-and-effect relationships, alternative explanations, supporting or rejecting a hypothesis or prediction

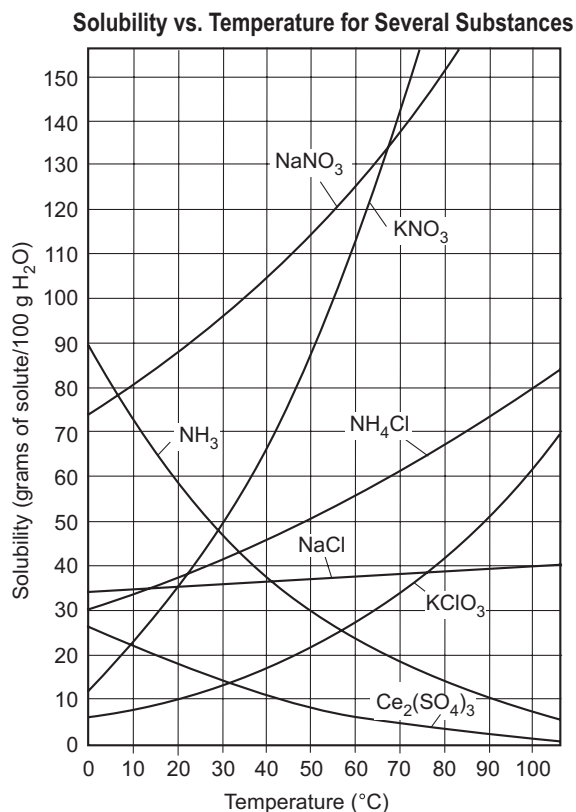

## Laboratory Activities

- Most chemistry texts provide at least one lab activity to determine the solubility of an ionic salt. Text references can be found in the Learning Resources Links for this outcome. There is also a microscale chemistry lab that can be done to examine the solubility behaviour of potassium nitrate,  $\text{KNO}_3$ .
- The lab outlined in Appendix 4.3: Constructing a Solubility Curve asks students to construct a solubility curve for ammonium chloride,  $\text{NH}_4\text{Cl}$ . Rather than having every student doing all points on the solubility curve, teachers could give each lab group a specific amount of solute to be dissolved in water to produce a given amount of solution. Student groups then perform the lab to determine one of the points on a solubility curve for the given solid. Data is shared with the class to generate the complete solubility curve.

**SPECIFIC LEARNING OUTCOME**

**C11-4-06:** Construct, from experimental data, a solubility curve of a pure substance in water.

(continued)

- 
3. If teachers have access to a calculator-based laboratory (CBL) system or temperature probes, they could have students do a lab activity to determine a complete solubility curve for a given solute species.

**SUGGESTIONS FOR ASSESSMENT**

---

**Laboratory Reports**

Assess student lab reports and performance during the lab activity using the Laboratory Report Outline (see *SYSTH* 11.38).

**Journal Writing**

Any journal reflections that students complete during or after a lab activity can help determine the ease with which they understand the lab directions. It is here that students can provide a personal interpretation of the events observed during a lab activity.

**Paper-and-Pencil Tasks**

Ask students to explain the type of solution that occurs when a sample is not on the solubility curve but below it or above it (i.e., saturated and unsaturated solutions). Students should also be able to use the solubility curve and other graphs to determine the solubility of amounts of solute dissolved in a given amount of solvent. The questions and discussion that occur during the treatment of learning outcome C11-4-06 will complement and introduce the following two learning outcomes (C11-4-07 and C11-4-08), which discuss saturated solutions and problem solving with solubility curves.

**SKILLS AND ATTITUDES OUTCOMES**

**C11-0-S7:** Interpret patterns and trends in data, and infer and explain relationships.

**C11-0-S8:** Evaluate data and data-collection methods for accuracy and precision.

Include: discrepancies in data, sources of error, percent error

**C11-0-S9:** Draw a conclusion based on the analysis and interpretation of data.

Include: cause-and-effect relationships, alternative explanations, supporting or rejecting a hypothesis or prediction

---

**LEARNING RESOURCES LINKS**

*Chemistry* (Chang 495)

*Chemistry* (Zumdahl and Zumdahl 522)

*Chemistry: The Central Science* (Brown, et al. 497)

*Chemistry: Concepts and Applications* (Phillips, Strozak, and Wistrom 459)

*Chemistry: The Molecular Nature of Matter and Change* (Silberberg 498)

*Glencoe Chemistry: Matter and Change* (Dingrando, et al. 457)

*McGraw-Hill Ryerson Chemistry, Combined Atlantic Edition* (Mustoe, et al. 249)

*McGraw-Hill Ryerson Chemistry 11, Ontario Edition* (Mustoe, et al. 295)

*Nelson Chemistry 11, Ontario Edition* (Jenkins, et al. 314)

*Prentice Hall Chemistry: Connections to Our Changing World* (LeMay, et al. 515)

**Investigations**

*Glencoe Chemistry: Matter and Change* (Dingrando, et al. 458 – the effect of temperature on solubility)

*Glencoe Chemistry: Matter and Change: Laboratory Manual – Teacher Edition* (113 – making a solubility curve)

*Glencoe Chemistry: Matter and Change: Small-Scale Laboratory Manual – Teacher Edition* (41 – the effect of temperature on solubility)

*McGraw-Hill Ryerson Chemistry 11, Ontario Edition* (Mustoe, et al. 296 – plotting solubility curves)

*McGraw-Hill Ryerson Chemistry, Combined Atlantic Edition* (Mustoe, et al. 249 – plotting solubility curves)

*Microscale Chemistry Laboratory Manual* (Slater and Rayner-Canham 29 – solubility curves)

*Nelson Chemistry 11, Ontario Edition* (Jenkins, et al. 314 – solubility curve of a solid)



## SPECIFIC LEARNING OUTCOME

**C11-4-07:** Differentiate among saturated, unsaturated, and supersaturated solutions.

(0.5 hour)

SLO: C11-4-07

## SUGGESTIONS FOR INSTRUCTION

### Entry-Level Knowledge

In Grade 7 Science (learning outcome 7-2-22), students were expected to differentiate between saturated and unsaturated solutions.

### Assessing Prior Knowledge

Check for student understanding of prior knowledge and review as necessary. Prior knowledge can be reviewed and/or assessed by using any of the KWL strategies (e.g., Concept Map, Knowledge Chart, Think-Pair-Share—see *SYSTH*, Chapter 9).

### TEACHER NOTES

The discussion before and after a previous lab (for learning outcome C11-4-05) may have included the use of the terms *saturated*, *unsaturated*, and *supersaturated*. Students may have observed *super cooling* during the experiment if stirring was not continuous and the cooling process was slow.

A discussion of the solubility curve that students have completed is an effective way to begin the discussion of the types of solutions that are possible.

- *Unsaturated solution*—a solution that holds less than the maximum amount of solute possible at a given temperature.
- *Saturated solution*—a solution that holds the maximum amount of solute possible at a given temperature.
- *Supersaturated solution*—a solution that holds more than the maximum amount of solute possible at a given temperature.

A supersaturated solution can be made by saturating a solution at a high temperature, and then cooling it very slowly. In this case, the solution holds more solute than it should at the temperature desired. These solutions tend to be rather

### General Learning Outcome Connections

- GLO C8:** Evaluate, from a scientific perspective, information and ideas encountered during investigations and in daily life.
- GLO D3:** Understand the properties and structures of matter, as well as various common manifestations and applications of the actions and interactions of matter.

**SKILLS AND ATTITUDES OUTCOMES**

**C11-0-U1:** Use appropriate strategies and skills to develop an understanding of chemical concepts.

*Examples: analogies, concept frames, concept maps, manipulatives, particulate representations, role-plays, simulations, sort-and-predict frames, word cycles...*

**C11-0-S7:** Interpret patterns and trends in data, and infer and explain relationships.

**C11-0-S9:** Draw a conclusion based on the analysis and interpretation of data.

*Include: cause-and-effect relationships, alternative explanations, supporting or rejecting a hypothesis or prediction*

---

unstable and are easily disturbed from this state. Supersaturated solutions often precipitate prematurely for two reasons:

- The vessel is dirty and the contaminating particles act as a seed to initiate precipitation.
- The solution is cooled too rapidly.

It is possible for some solutions to be so supersaturated that even a slight jarring will cause rapid precipitation.

**Demonstrations/Discrepant Events**

1. In the treatment of learning outcome C11-4-01, students may have seen “the impossible transfer trick.” The demonstration could be done again to reinforce the concept of supersaturation. Students can check the temperature of the solid sodium acetate and discover that it is quite high. The precipitation is exothermic.
2. A much simpler demonstration can be done with supersaturating a solution of sodium thiosulphate. If a microscopic slide projector is available in the biology lab at school, either of these supersaturated solutions (the sodium acetate solution or the sodium thiosulphate solution) could be poured into a petri dish that is already on the projector stage. If left to stand, the solution will precipitate and students will clearly be able to see the rapid growth and shape of the crystals.

**Laboratory Activities**

1. Have students distinguish between the three types of solutions by doing the lab activity outlined in Appendix 4.4: Unsaturated, Saturated, and Supersaturated Solutions.
2. In another lab activity, described in Appendix 4.5: Crystals and Crystal Growing, students use their knowledge from the previous lab to grow crystals. If possible, have all students grow crystals and have a competition to decide upon the purest and the largest crystal grown.





**SPECIFIC LEARNING OUTCOME**

**C11-4-07:** Differentiate among saturated, unsaturated, and supersaturated solutions.

(continued)



**SUGGESTIONS FOR ASSESSMENT**

---

**Rubrics/Checklists**

See Appendix 10 for a variety of rubrics and checklists that can be used for self-assessment, peer assessment, and teacher assessment.

**Paper-and-Pencil Tasks**

Students could do an entry-level activity using a Compare and Contrast frame for unsaturated and saturated solutions (see *SYSTH* 10.24).

**Laboratory Reports**

The lab activities outlined for this learning outcome could be assessed by using questions and answers from the data collected from the various activities.

**Demonstration**

Students could be selected to demonstrate the supersaturation lab with either sodium thiosulphate or sodium acetate. Assessment could be done using a presentation rubric found in Appendix 10 of this document.

**Journal Writing**

Ask students to reflect on how they might use the discrepant event, “the impossible transfer trick,” in a magic show or how they could improve on the demonstration.

**LEARNING RESOURCES LINKS**

---



*Chemistry* (Chang 488)

*Chemistry: The Central Science* (Brown, et al. 491)

*Chemistry: Concepts and Applications* (Phillips, Strozak, and Wistrom 458)

*Chemistry: The Molecular Nature of Matter and Change* (Silberberg 498)

*Glencoe Chemistry: Matter and Change* (Dingrando, et al. 265)

*Prentice Hall Chemistry: Connections to Our Changing World* (LeMay, et al. 512)

**SKILLS AND ATTITUDES OUTCOMES**

**C11-0-U1:** Use appropriate strategies and skills to develop an understanding of chemical concepts.

*Examples: analogies, concept frames, concept maps, manipulatives, particulate representations, role-plays, simulations, sort-and-predict frames, word cycles...*

**C11-0-S7:** Interpret patterns and trends in data, and infer and explain relationships.

**C11-0-S9:** Draw a conclusion based on the analysis and interpretation of data.

Include: cause-and-effect relationships, alternative explanations, supporting or rejecting a hypothesis or prediction

---

**NOTES**



## SPECIFIC LEARNING OUTCOME

C11-4-08: Use a graph of solubility data to solve problems.

(1.5 hours)

SLO: C11-4-08

## SUGGESTIONS FOR INSTRUCTION

## Entry-Level Knowledge

Students should have been familiarized with the term *grams of solute per 100 mL* from Grade 7 Science (learning outcome 7-2-21). They should also have an understanding of the terms *unsaturated*, *saturated*, and *supersaturated*. Some review will be necessary at this point.

## TEACHER NOTES

There are three methods to saturate a solution:

- Add more solute.
- Decrease the temperature (for most solids).
- Evaporate the solvent.

## Enrichment/Extension

Problems associated with evaporating the solvent can be more complex than the other two methods of saturating a solution. Such problems would be considered to be enrichment or an extension of this learning outcome.

Use a graph of solubility data that shows

- solids that have an increase in solubility with an increase in temperature
- solids that have a decrease in solubility with an increase in temperature

It may also be useful to include a gas on the graph, as the solubility of gases is discussed in learning outcome C11-4-09.

The following Sample Problems and Solutions are provided as a guide to using the solubility data from the sample solubility curve provided. For a full-page graph, see Appendix 4.6: Solubility Curve.

## General Learning Outcome Connections

**GLO C7:** Work cooperatively and value the ideas and contributions of others while carrying out scientific and technological activities.

**GLO C8:** Evaluate, from a scientific perspective, information and ideas encountered during investigations and in daily life.

**SKILLS AND ATTITUDES OUTCOMES**

**C11-0-U2:** Demonstrate an understanding of chemical concepts.

*Examples: use accurate scientific vocabulary, explain concepts to others, compare and contrast concepts, apply knowledge to new situations and/or contexts, create analogies, use manipulatives...*

**C11-0-S2:** State a testable hypothesis or prediction based on background data or on observed events.

**C11-0-S7:** Interpret patterns and trends in data, and infer and explain relationships.

**C11-0-S8:** Evaluate data and data-collection methods for accuracy and precision.

Include: discrepancies in data, sources of error, percent error

**Sample Problems and Solutions**

1. What is the solubility of potassium nitrate,  $\text{KNO}_3$ , at  $44^\circ\text{C}$ ?

*Answer:* 72 g of solute/100 g of water

2. 25 g of potassium nitrate is dissolved in 50 g of water at  $30^\circ\text{C}$ . Determine whether this solution is saturated. If yes, explain why.

*Answer:* 25 g/50 g of water = 50 g/100 g of water

If this value is transferred to the solubility curve graph, the point is exactly on the line, which means that the solution must be saturated at  $30^\circ\text{C}$ .

3. A solution contains 5.2 g of potassium nitrate,  $\text{KNO}_3$ , dissolved in 10 g of water at  $40^\circ\text{C}$ . What amount of  $\text{KNO}_3$  would be required to saturate this solution?

*Answer:* 5.2 g/10 g of water = 52 g/100 g of water

This places the point on the solubility curve graph below the saturation curve. It would require 12 g/100 g of water to move the solution to the saturation line or 1.2 g/10 g of water.

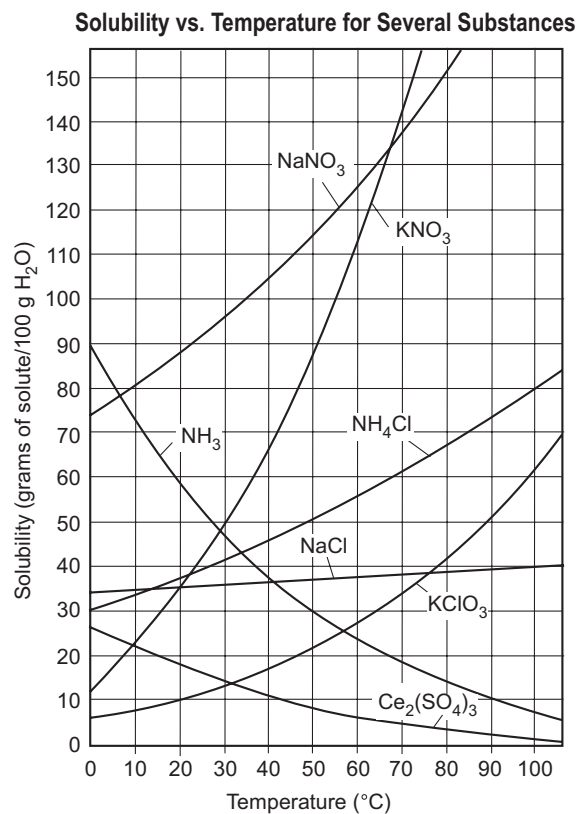

**SPECIFIC LEARNING OUTCOME****C11-4-08:** Use a graph of solubility data to solve problems.*(continued)*

4. A solution contains 33 g of  $\text{KNO}_3$ /30 g of water at  $72^\circ\text{C}$ . How much must this solution be cooled to saturate the solution?

*Answer:* 33 g/30 g of water = 110 g/100 g of water

If this data is transferred to the solubility curve graph, the point is to the right of the saturation curve. To saturate this solution, the temperature would need to be cooled  $14^\circ\text{C}$  to  $58^\circ\text{C}$ .

**Laboratory Activity: Extension**

Precipitation solution reactions are not part of Grade 11 Chemistry. However, now that students have a clear understanding to solubility, teachers could develop solubility rules as an extension activity with interested students.

**SUGGESTIONS FOR ASSESSMENT****Verbal Explanations**

Ask students to give verbal explanations in responding to questions related to solubility and unsaturated, saturated, and supersaturated solutions. These questions would be most logically answered if they related to a graph similar to the one provided in Appendix 4.6: Solubility Curve.

**Paper-and-Pencil Tasks**

Students should be able to solve problems that relate to the sample problems provided for learning outcome C11-4-08.

**SKILLS AND ATTITUDES OUTCOMES**

**C11-0-U2:** Demonstrate an understanding of chemical concepts.

*Examples: use accurate scientific vocabulary, explain concepts to others, compare and contrast concepts, apply knowledge to new situations and/or contexts, create analogies, use manipulatives...*

**C11-0-S2:** State a testable hypothesis or prediction based on background data or on observed events.

**C11-0-S7:** Interpret patterns and trends in data, and infer and explain relationships.

**C11-0-S8:** Evaluate data and data-collection methods for accuracy and precision.

Include: discrepancies in data, sources of error, percent error

---

**NOTES**

**SPECIFIC LEARNING OUTCOME**

**C11-4-09:** Explain how a change in temperature affects the solubility of gases.

(0.5 hour)

SLO: C11-4-09

**SUGGESTIONS FOR INSTRUCTION****Entry-Level Knowledge**

The solubility of gases in liquids has not been discussed in previous grades. In Grade 11 Chemistry, the physical properties of gases were addressed in learning outcome C11-2-01. These properties were explained using the Kinetic Molecular Theory (C11-1-02).

**Assessing Prior Knowledge**

Check for student understanding of prior knowledge and review as necessary. Prior knowledge can be reviewed and/or assessed by using any of the KWL strategies (e.g., Concept Map, Knowledge Chart, Think-Pair-Share—see *SYSTH*, Chapter 9).

**TEACHER NOTES**

To explain how a change in temperature affects the solubility of gases, teachers first need to review heat of solution (C11-4-04). The reason that the solubility of solids is so variable is that much of the energy for solvation is required to separate the solid particles from each other in the crystal lattice or from the molecular solid structure itself. This energy absorption is not required for a gas because all the particles are already separated. Consequently, the overall net process becomes exothermic, with the result that solubility is inversely proportional to temperature. The higher kinetic energy of gas particles allows them to escape from a solution more readily. As a result, the solubility of gases decreases with an increase in temperature.

More detailed explanations are available in the some of the chemistry texts referenced in the Learning Resource Links.

**General Learning Outcome Connections**

- GLO B3:** Identify the factors that affect health, and explain the relationships among personal habits, lifestyle choices, and human health, both individual and social.
- GLO B5:** Identify and demonstrate actions that promote a sustainable environment, society, and economy, both locally and globally.
- GLO D3:** Understand the properties and structures of matter, as well as various common manifestations and applications of the actions and interactions of matter.
- GLO E4:** Recognize that energy, whether transmitted or transformed, is the driving force of both movement and change, and is inherent within materials and in the interactions among them.

**SKILLS AND ATTITUDES OUTCOMES**

**C11-0-U2:** Demonstrate an understanding of chemical concepts.

*Examples: use accurate scientific vocabulary, explain concepts to others, compare and contrast concepts, apply knowledge to new situations and/or contexts, create analogies, use manipulatives...*

**C11-0-D1:** Identify and explore a current STSE issue.

*Examples: clarify what the issue is, identify different viewpoints and/or stakeholders, research existing data/information...*

**C11-0-D2:** Evaluate implications of possible alternatives or positions related to an STSE issue.

*Examples: positive and negative consequences of a decision, strengths and weaknesses of a position...*

---

**Demonstration/Activity**

In a demonstration/activity found in *Nelson Chemistry 11* (Jenkins, *et al.* 317), students are asked to make observations and answer questions about the release of air bubbles from water during warming.

**STSE Issues**

This learning outcome provides an opportunity for students to become more aware of STSE issues.

The relationship between the solubility of a gas and the temperature is important for oxygen-dependent aquatic life. When the organisms living in a stable aquatic environment are suddenly stressed by a change in the temperature of the water, their health may become compromised if they cannot move to a friendlier environment.

There are many instances where thermal pollution is becoming an environmental concern in the vicinity of power plants and large industrial complexes that use water for cooling.

**STSE Decision-Making Issue**

Have students research and examine local thermal contamination. Students review the pros and cons of the issue and then make decisions that relate to the environment.

**Research Activity**

Have students research local companies or industries that release thermal energy into the rivers and streams around them.



**SPECIFIC LEARNING OUTCOME**

**C11-4-09:** Explain how a change in temperature affects the solubility of gases.

(continued)

---

**SUGGESTIONS FOR ASSESSMENT**

---

**Rubrics/Checklists**

See Appendix 10 for a variety of rubrics and checklists that can be used for self-assessment, peer assessment, and teacher assessment.

**Research Reports**

Have students research and report either individually or in small groups. The information collected could be presented as

- written reports
- oral presentations
- bulletin board displays
- multimedia presentations

**Visual Displays**

Students could present the material they have collected using

- posters
- pamphlets
- bulletin boards

Each of these presentation styles could be assessed using an appropriate rubric created with students prior to the assignment. Samples of presentation rubrics are provided in Appendix 10 of this document.

**Activity Reports**

The activities outlined for this learning outcome could be assessed as formal lab reports using the Laboratory Report Outline or the Laboratory Report Format (see *SYSTH* 11.38, 14.12) or by using questions and answers from the data collected from the activities.

**Journal Writing**

Have students write a journal entry commenting on the extent of thermal pollution in their community. Is the concern connected to the economic development of the community?

**SKILLS AND ATTITUDES OUTCOMES**

**C11-0-U2:** Demonstrate an understanding of chemical concepts.

*Examples: use accurate scientific vocabulary, explain concepts to others, compare and contrast concepts, apply knowledge to new situations and/or contexts, create analogies, use manipulatives...*

**C11-0-D1:** Identify and explore a current STSE issue.

*Examples: clarify what the issue is, identify different viewpoints and/or stakeholders, research existing data/information...*

**C11-0-D2:** Evaluate implications of possible alternatives or positions related to an STSE issue.

*Examples: positive and negative consequences of a decision, strengths and weaknesses of a position...*

---

**LEARNING RESOURCES LINKS**

---



*Chemistry* (Chang 496)

*Chemistry* (Zumdahl and Zumdahl 524)

*Chemistry: The Central Science* (Brown, et al. 497)

*Chemistry: The Molecular Nature of Matter and Change* (Silberberg 499)

*Glencoe Chemistry: Matter and Change* (Dingrando, et al. 515)

*Nelson Chemistry 11, Ontario Edition* (Jenkins, et al. 317)

**Investigations**

*McGraw-Hill Ryerson Chemistry, Combined Atlantic Edition* (Mustoe, et al. 25—  
The Effect of Temperature on Soda Water)

*McGraw-Hill Ryerson Chemistry 11, Ontario Edition* (Mustoe, et al. 298—The  
Effect of Temperature on Soda Water)

*Nelson Chemistry 11, Ontario Edition* (Jenkins, et al. 318—Solubility of a Gas)

**Thermal Pollution**

*Chemistry* (Chang 960)

*Chemistry* (Zumdahl and Zumdahl 523)

*Chemistry: The Central Science* (Brown, et al. 497)

*Chemistry: The Molecular Nature of Matter and Change* (Silberberg 499)

*McGraw-Hill Ryerson Chemistry, Combined Atlantic Edition* (Mustoe, et al. 251)

*McGraw-Hill Ryerson Chemistry 11, Ontario Edition* (Mustoe, et al. 298)

*Prentice Hall Chemistry: Connections to Our Changing World* (LeMay, et al. 764)



## SPECIFIC LEARNING OUTCOME

**C11-4-10:** Explain how a change in pressure affects the solubility of gases.

(0.5 hour)

SLO: C11-4-10

### SUGGESTIONS FOR INSTRUCTION

#### Entry-Level Knowledge

Students will be familiar with the experience of opening a container of a carbonated beverage and having it “whoosh” out the top once the pressure has been released, but they will not likely be able to explain it.

#### TEACHER NOTES

Teachers can introduce the topic of how a change in pressure affects the solubility of gases by cracking open a can of pop and asking questions for class discussion.

#### Questions for Class Discussion

Before opening a container of carbonated beverage, ask students to respond to questions such as these:

1. Is this a solution? (*Yes*)
2. What is (are) the solute(s)? (*Carbon dioxide, sugar, citric acid, etc.*)
3. What is the solvent? (*Water*)
4. What type of solution is this? (*Gas-solid-liquid solution*)
5. Are the solutes and solvent polar or non-polar? (*Since water is polar, most of the solutes will be polar. However, carbon dioxide is non-polar and is inserted into the water solution under pressure.*)

After opening the container, ask:

6. Why does the drink make a popping or fizzing noise when you open it? (*When the cap is removed, pressure is released, decreasing the solubility of the gas in the liquid, and the gas escapes.*)

In discussing this topic, students should learn that the solubility of solids and liquids is not affected by pressure but the solubility of a gas in a liquid is greatly affected by pressure.

#### General Learning Outcome Connections

- GLO B3:** Identify the factors that affect health, and explain the relationships among personal habits, lifestyle choices, and human health, both individual and social.
- GLO D3:** Understand the properties and structures of matter, as well as various common manifestations and applications of the actions and interactions of matter.
- GLO E4:** Recognize that energy, whether transmitted or transformed, is the driving force of both movement and change, and is inherent within materials and in the interactions among them.

**SKILLS AND ATTITUDES OUTCOMES**

**C11-0-U1:** Use appropriate strategies and skills to develop an understanding of chemical concepts.

*Examples: analogies, concept frames, concept maps, manipulatives, particulate representations, role-plays, simulations, sort-and-predict frames, word cycles...*

**C11-0-U2:** Demonstrate an understanding of chemical concepts.

*Examples: use accurate scientific vocabulary, explain concepts to others, compare and contrast concepts, apply knowledge to new situations and/or contexts, create analogies, use manipulatives...*

In an established gas/liquid solution (e.g., dissolved CO<sub>2</sub> gas in a carbonated drink), there is a dynamic equilibrium between the rate at which gas particles are entering the solution phase and the number of particles leaving the solution phase. If the pressure above the solution is increased, there will be more gas particles striking the surface. As a result, the rate of dissolving will exceed the rate at which particles are leaving the liquid phase and the solubility of the gas in the liquid will increase. After a while, the equilibrium is re-established at a faster rate, but with more gas dissolved in the solution.

**Henry's Law**

The mathematical relationship between the partial pressure of a gas over a solution and the solubility of the gas at a fixed temperature is called Henry's Law. (It is not necessary that students remember this relationship.)

The formula for this relationship is:  $C = kP$

C = the concentration of the dissolved gas

k = a constant characteristic of a particular solution

P = the partial pressure of the gas over the liquid

This law is most accurate for gases that do not dissociate in or react with the liquid (e.g., Henry's Law is accurate for dissolved oxygen gas but not, for instance, HCl, which easily dissociates in solution).

This relationship is very important to scuba divers (divers using a self-contained underwater breathing apparatus) who are affected by water pressure as they dive. As a diver descends, the ambient pressure increases dramatically. At 40 m (132 ft.) in salt water, the ambient pressure will have risen to about 5 atmospheres (equivalent to ~ 505 kPa). This causes air to become dissolved in the diver's body fluids as solubility increases. The danger is that when the diver ascends, the solubility decreases and the dissolved gases come out of solution. This effect is compounded by the fact that the gas bubbles are also increasing in volume as the pressure decreases around the diver (see Boyle's Law, learning outcome C11-2-05).

These gas bubbles can cause undesirable damage to the body tissues if the ascent is too rapid. To be as safe as possible, divers are required to *ascend slower than the smallest bubbles escaping from their regulators*. This translates to about 20 m per minute. The slower the ascent is, the better it is for the diver.

**SPECIFIC LEARNING OUTCOME**

**C11-4-10:** Explain how a change in pressure affects the solubility of gases.

(continued)

Almost every scuba certification body has developed dive tables that enable divers to plan a safe dive according to an assumed physiology. According to these tables, if divers have “maxed out” their bottom time by going too deep or by being there for too long, or both, they would be required to make safety stops as they ascend. This would allow the gas bubbles to escape slowly from their body tissues.



For additional information about scuba diving, contact the nearest scuba certifying agency. The following websites, for example, will provide a list of the diving shops in Manitoba:

- Professional Association of Diving Instructors (PADI): <<http://www.padi.com>>
- Association of Canadian Underwater Councils (ACUC): <<http://www.acuc.ca>>

**SUGGESTIONS FOR ASSESSMENT****Rubrics/Checklists**

See Appendix 10 for a variety of rubrics and checklists that can be used for self-assessment, peer assessment, and teacher assessment.

**Journal Writing**

Students may want to investigate the world of scuba diving or express their interest in exploring the underwater world of diving through journal entries.

**Paper-and-Pencil Tasks**

Students should be able to explain the relationship between the external gas pressure above the solution and the solubility of the gas. They should also be able to make several applications of this relationship.

**SKILLS AND ATTITUDES OUTCOMES**

**C11-0-U1:** Use appropriate strategies and skills to develop an understanding of chemical concepts.

*Examples: analogies, concept frames, concept maps, manipulatives, particulate representations, role-plays, simulations, sort-and-predict frames, word cycles...*

**C11-0-U2:** Demonstrate an understanding of chemical concepts.

*Examples: use accurate scientific vocabulary, explain concepts to others, compare and contrast concepts, apply knowledge to new situations and/or contexts, create analogies, use manipulatives...*

---

**LEARNING RESOURCES LINKS**

---



*Chemistry* (Chang 497)

*Chemistry* (Zumdahl and Zumdahl 521)

*Chemistry: The Central Science* (Brown, et al. 496)

*Chemistry: The Molecular Nature of Matter and Change* (Silberberg 500)

*Glencoe Chemistry: Matter and Change* (Dingrando, et al. 460)

*McGraw-Hill Ryerson Chemistry, Combined Atlantic Edition* (Mustoe, et al. 252)

*McGraw-Hill Ryerson Chemistry 11, Ontario Edition* (Mustoe, et al. 299)

*Nelson Chemistry 12: College Preparation, Ontario Edition* (Davies, et al. 340)

*Prentice Hall Chemistry: Connections to Our Changing World* (LeMay, et al. 517)

**SPECIFIC LEARNING OUTCOME**

**C11-4-11:** Perform a lab to demonstrate freezing-point depression and boiling-point elevation.

**(1.5 hours)**

SLO: C11-4-11

**SUGGESTIONS FOR INSTRUCTION****Entry-Level Knowledge**

Other than knowing that salt placed on ice causes it to melt, students may have no prior experience with freezing-point depression and boiling-point elevation. This learning outcome provides an opportunity to introduce another STSE issue. For, example, students could research where all the salt goes after the ice on the roads melts in the spring.

**TEACHER NOTES**

The lab activities presented in this document are meant to be qualitative. As the lab investigations outlined for this learning outcome will take considerable time, the class could form groups, with each group doing only one of the experiments.

For a class of 24 students, for example, there could be 12 groups of two students doing the following lab activities:

- Groups 1 and 2: Melting point and freezing point of pure water
- Groups 3, 4, 5, and 6: Melting point and freezing point of salt, NaCl, solution
- Groups 7 and 8: Boiling point of pure water
- Groups 9, 10, 11, and 12: Boiling point of ethylene glycol solution

If students' lab skills have not sufficiently developed by this time, an alternative lab format would need to be considered.

**General Learning Outcome Connections**

- GLO C1:** Recognize safety symbols and practices related to scientific and technological activities and to their daily lives, and apply this knowledge in appropriate situations.
- GLO C2:** Demonstrate appropriate scientific inquiry skills when seeking answers to questions.
- GLO C3:** Demonstrate appropriate problem-solving skills when seeking solutions to technological challenges.
- GLO C7:** Work cooperatively and value the ideas and contributions of others while carrying out scientific and technological activities.
- GLO D3:** Understand the properties and structures of matter, as well as various common manifestations and applications of the actions and interactions of matter.

**SKILLS AND ATTITUDES OUTCOMES**

**C11-0-S5:** Collect, record, organize, and display data using an appropriate format.

*Examples: labelled diagrams, graphs, multimedia applications, software integration, probeware*

**C11-0-S7:** Interpret patterns and trends in data, and infer and explain relationships.

**C11-0-S9:** Draw a conclusion based on the analysis and interpretation of data.

*Include: cause-and-effect relationships, alternative explanations, supporting or rejecting a hypothesis or prediction*

---

**Laboratory Activities****1. The Effects of Salt and Antifreeze on the Melting Point of Ice**

Students repeatedly add specified amounts of coarse salt to an ice and water mixture. They take the temperature of the solution regularly to collect data showing the relationship between the amount of salt added and the present temperature of the salt-ice-water mixture. For a complete lab procedure, see Appendix 4.7: The Effects of Salt and Antifreeze on the Melting Point of Ice.

If students have not experienced determining the melting point and/or freezing point of water under ambient conditions, this should be done first as a benchmark. The procedure for such an activity is found in many readily available chemistry resources.

**2. The Effect of Antifreeze on the Boiling Point of Water**

As the boiling point elevation for water is relatively small ( $0.52^{\circ}\text{C}$  for a 1 molal solution), students should first measure the actual boiling point (BP) of water in their lab to establish a reference value. The BP for water will most likely be  $100 \pm 2^{\circ}\text{C}$ . After students have determined the normal BP for water, they would complete a similar lab using repeated aliquots of ethylene glycol to determine the effect on the boiling point of adding solute. For a complete lab procedure, see Appendix 4.8: The Effect of Antifreeze on the Boiling Point of Water.

**3. Heat Transfer**

A novel lab activity that students can do easily in one lab period with a minimal amount of equipment is the manufacture of ice cream. The results also taste quite good. For a write-up of this qualitative, enjoyable lab activity, see Appendix 4.9: Heat Transfer: I Scream, You Scream, We All Scream for Ice Cream.

**Extension:** One of the student groups could determine the maximum temperature possible with the repeated addition of salt to the ice-water mixture. This lab requires a large amount of salt due to its modest solubility.

**4. Probeware**

If probeware and computers are available, students can do a lab procedure in which they accurately measure the effect on the freezing point of a pure solvent by adding a solute. See Appendix 4.10: The Effect of Salt on the Melting Point of Ice.



**SPECIFIC LEARNING OUTCOME**

**C11-4-11:** Perform a lab to demonstrate freezing-point depression and boiling-point elevation.

(continued)

---

**SUGGESTIONS FOR ASSESSMENT**

---

**Rubrics/Checklists**

See Appendix 10 for a variety of rubrics and checklists that can be used for self-assessment, peer assessment, and teacher assessment.

**Laboratory Reports**

The lab activities outlined for this learning outcome could be assessed as formal lab reports using the Laboratory Report Outline or the Laboratory Report Format (see *SYSTH* 11.38, 14.12) or by using questions and answers from the data collected from the activities.

**Journal Writing**

1. Students may wish to address an STSE issue by describing the pros and cons of adding salt to the sand used on icy roads in winter.
2. Another journal entry could be devoted to the manufacture of the best ice cream sample.

**Paper-and-Pencil Tasks**

A series of lab questions and discussion items can be found in the lab procedures associated with each of the lab activities.

**Written Reports**

Depending on the time available and the enthusiasm of the class, students could write a brief report on the pros and cons of salting ice-covered roads compared to the economic cost of automobile damage from salt corrosion.

### SKILLS AND ATTITUDES OUTCOMES

**C11-0-S5:** Collect, record, organize, and display data using an appropriate format.

*Examples: labelled diagrams, graphs, multimedia applications, software integration, probeware*

**C11-0-S7:** Interpret patterns and trends in data, and infer and explain relationships.

**C11-0-S9:** Draw a conclusion based on the analysis and interpretation of data.

*Include: cause-and-effect relationships, alternative explanations, supporting or rejecting a hypothesis or prediction*

---

### LEARNING RESOURCES LINKS

---



*Chemistry* (Zumdahl and Zumdahl 531)

*Chemistry: The Central Science* (Brown, et al. 502)

*Chemistry: Concepts and Applications* (Phillips, Strozak, and Wistrom 465)

*Chemistry: The Molecular Nature of Matter and Change* (Silberberg 506)

*Glencoe Chemistry: Matter and Change* (Dingrando, et al. 472)

*Prentice Hall Chemistry: Connections to Our Changing World* (LeMay, et al. 520)

#### Activities

*Glencoe Chemistry: Matter and Change* (Dingrando, et al. 472 – Making of Ice Cream)

*Prentice Hall Chemistry: Connections to Our Changing World* (LeMay, et al. 520 – Ethylene Glycol Demonstration)

#### STSE

*Chemistry* (Chang 504)

*Chemistry: The Molecular Nature of Matter and Change* (Silberberg 512 – Colligative Properties in Industry and Biology)



## SPECIFIC LEARNING OUTCOME

**C11-4-12:** Explain freezing-point depression and boiling-point elevation at the molecular level.

Examples: antifreeze, road salt...

(0.5 hour)

SLO: C11-4-12

## SUGGESTIONS FOR INSTRUCTION

## Entry-Level Knowledge

The only prior knowledge students may have is noted in relation to learning outcome C11-4-11. However, students now have completed the lab to demonstrate freezing-point depression and boiling-point elevation and will be curious about the explanation. Students may be able to propose explanations if they understand the Kinetic Molecular Theory.

## Assessing Prior Knowledge

Check for student understanding of prior knowledge and review as necessary. Prior knowledge can be reviewed and/or assessed by using any of the KWL strategies (e.g., Concept Map, Knowledge Chart, Think-Pair-Share—see *SYSTH*, Chapter 9).

## TEACHER NOTES

Most chemistry textbooks provide a triple-point diagram for either the freezing-point depression or the boiling-point elevation (see sample diagram). These diagrams may be difficult for students to understand.

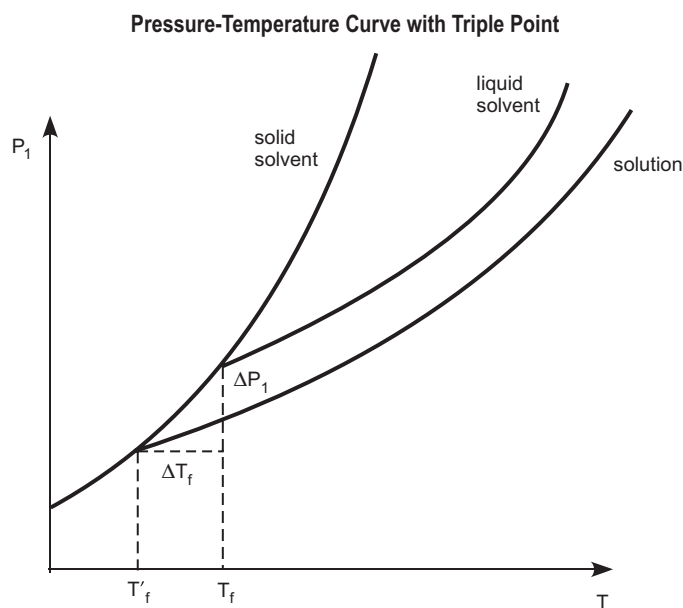

## General Learning Outcome Connections

- GLO A1:** Recognize both the power and limitations of science as a way of answering questions about the world and explaining natural phenomena.
- GLO A5:** Recognize that science and technology interact with and advance one another.
- GLO D3:** Understand the properties and structures of matter, as well as various common manifestations and applications of the actions and interactions of matter.

**SKILLS AND ATTITUDES OUTCOMES**

**C11-0-U1:** Use appropriate strategies and skills to develop an understanding of chemical concepts.

*Examples: analogies, concept frames, concept maps, manipulatives, particulate representations, role-plays, simulations, sort-and-predict frames, word cycles...*

**C11-0-U2:** Demonstrate an understanding of chemical concepts.

*Examples: use accurate scientific vocabulary, explain concepts to others, compare and contrast concepts, apply knowledge to new situations and/or contexts, create analogies, use manipulatives...*

---

**Boiling-Point Elevation**

If we add solute to a solvent, the vapour pressure of the solution is lowered. A mathematical relationship that relates vapour pressure to the partial pressure of the gas being dissolved is called *Raoult's Law*.

Raoult's Law can be expressed quantitatively as follows: A solvent's vapour pressure in solution is equal to its mole fraction times its vapour pressure as a pure liquid, from which it follows that the freezing-point depression and the boiling-point elevation are directly proportional to the molality of the solute.

Put another way, the addition of solute to a liquid lessens the tendency for the liquid to become a solid or a gas (i.e., the addition reduces the freezing point and the vapour pressure). Teachers will not consider an algorithmic treatment at this level with students.

This complicated relationship can be explained to students by attending to the following considerations:

- At the surface of the solution where evaporation occurs, there are fewer solvent particles due to the presence of solute particles: that is, reduced vapour pressure.
- The solute particles absorb energy and, therefore, reduce the energy available to evaporate the solvent particles: yes, reduced vapour pressure.
- Energy is required to overcome the intermolecular forces between the solute and the solvent particles: again, reduced vapour pressure.

Since the definition of boiling is the temperature at which the vapour pressure equals the pressure above the liquid, it can readily be seen that if the vapour pressure is lowered, it will require additional energy to raise the temperature to where the vapour pressure equals that of the pressure above the solution. Hence, the boiling-point elevation.

**Freezing-Point Depression**

For a liquid to freeze, it must achieve an ordered state that results in the formation of a crystal. If there are impurities in the liquid (i.e., solute), then the liquid is inherently less ordered. Therefore, a solution is more difficult to freeze than the pure solvent, and a lower temperature is required to freeze the solution.

**SPECIFIC LEARNING OUTCOME**

**C11-4-12:** Explain freezing-point depression and boiling-point elevation at the molecular level.

*Examples: antifreeze, road salt...*

*(continued)*

Another way to explain this concept is to say that, as a solution is cooled, solvent molecules lose average kinetic energy to enable them to settle into the crystal structure of the pure solvent. As the crystal grows, solute molecules interfere with the growth of the solvent crystals. To compensate, more kinetic energy must be taken from the solution, thus depressing the freezing point.

The examples of antifreeze and salt (identified in the learning outcome) can be used to provide a real-life situation where this relationship is useful.

Point out to students that, logically, any solute that releases more than one particle into the solution when it undergoes solvation would have an even greater effect (e.g., an ionic solid such as  $\text{CaCl}_2$  releases three ions per one molecule of calcium chloride).

**STSE Decision-Making Issue**

Learning outcome C11-4-12 provides an opportunity for students to become more aware of their environment by using a local STSE concern linked to the decision-making process.

**SUGGESTIONS FOR ASSESSMENT****Rubrics/Checklists**

See Appendix 10 for a variety of rubrics and checklists that can be used for self-assessment, peer assessment, and teacher assessment.

**Journal Writing**

Students may wish to describe what effects the melting-point depression and boiling-point elevation have on their lives.

**Paper-and-Pencil Tasks**

Students should be able to explain the phenomena of freezing-point depression and boiling-point elevation.

### SKILLS AND ATTITUDES OUTCOMES

**C11-0-U1:** Use appropriate strategies and skills to develop an understanding of chemical concepts.

*Examples: analogies, concept frames, concept maps, manipulatives, particulate representations, role-plays, simulations, sort-and-predict frames, word cycles...*

**C11-0-U2:** Demonstrate an understanding of chemical concepts.

*Examples: use accurate scientific vocabulary, explain concepts to others, compare and contrast concepts, apply knowledge to new situations and/or contexts, create analogies, use manipulatives...*

---

### LEARNING RESOURCES LINKS

---



*Chemistry (Chang 504)*

*Chemistry (Zumdahl and Zumdahl 531)*

*Chemistry: The Central Science (Brown, et al. 502)*

*Chemistry: Concepts and Applications (Phillips, Strozak, and Wistrom 465)*

*Chemistry: The Molecular Nature of Matter and Change (Silberberg 506)*

*Glencoe Chemistry: Matter and Change (Dingrando, et al. 472)*

*Prentice Hall Chemistry: Connections to Our Changing World (LeMay, et al. 520)*

**SPECIFIC LEARNING OUTCOME**

**C11-4-13:** Differentiate among, and give examples of, the use of various representations of concentration.

Include: grams per litre (g/L), % weight-weight (% w/w), % weight-volume (% w/v), % volume/volume (% v/v), parts per million (ppm), parts per billion (ppb), moles per litre (mol/L) (molarity)

(0.5 hour)

SLO: C11-4-13

**SUGGESTIONS FOR INSTRUCTION****Entry-Level Knowledge**

Students may be familiar with grams per litre (g/L). They may also have seen references to parts per million (ppm) and parts per billion (ppb) in magazines and books. In Grade 7 Science, units of grams solute/100 mL liquid became standard usage for concentration.

**TEACHER NOTES**

Ensure that students become aware of the various ways in which concentration can be expressed. It is not the intention, however, that students should convert from one unit to another. Percent units are typically used by research facilities that are more interested in being able to make solutions quickly than in having to calculate moles and then concentration.

**Representations of Concentrations**

**g/L** = grams of solute in 1 L of solution

**% w/w** =  $\frac{\text{mass of solute (g)} \times 100}{100 \text{ g of solution}}$

**% w/v** =  $\frac{\text{mass of solute (g)} \times 100}{100 \text{ mL of solution}}$

**% v/v** =  $\frac{\text{volume of solute (mL)} \times 100}{100 \text{ mL of solution}}$

**ppm** = parts per million

*Example:* 10 ppm sodium ions in water = 10 sodium ions in 1 million particles of water

**ppb** = parts per billion

*Example:* 10 ppb iron in water = 10 particles of iron in 1 billion particles of water

**General Learning Outcome Connections**

**GLO C3:** Demonstrate appropriate problem-solving skills when seeking solutions to technological challenges.

**GLO D3:** Understand the properties and structures of matter, as well as various common manifestations and applications of the actions and interactions of matter.

**SKILLS AND ATTITUDES OUTCOMES**

**C11-0-U1:** Use appropriate strategies and skills to develop an understanding of chemical concepts.

*Examples: analogies, concept frames, concept maps, manipulatives, particulate representations, role-plays, simulations, sort-and-predict frames, word cycles...*

**C11-0-U2:** Demonstrate an understanding of chemical concepts.

*Examples: use accurate scientific vocabulary, explain concepts to others, compare and contrast concepts, apply knowledge to new situations and/or contexts, create analogies, use manipulatives...*

Students should know what is meant by molarity. Although *molarity* is not an SI (Système International) unit, it is commonly used as a unit to represent concentration. As we are in a metric learning environment, it is preferred that mol/L be used as much as possible.

$$\text{Molarity (M)} = \frac{\text{moles of solute}}{\text{litres of solution}}$$

$$\text{Concentration} = \frac{\text{moles of solute}}{\text{litres of solution}} \quad (\text{Some teachers may use C for concentration.})$$

**Activity**

Have students find magazine or newspaper articles that contain any of the concentration units listed above. Students could display the articles, describe the units, and indicate how they are used in the articles.

**Internet Activity**

For an Internet activity dealing with solutions, see Appendix 4.11: A WebQuest for Solubility Units.

**Sample Concentration Problems**

A few sample problems are given below to introduce the next learning outcome (C11-4-14), which requires students to solve concentration problems.

1. Determine the amount of sodium nitrate,  $\text{NaNO}_3$ , required to make 50 mL of a 0.40 mole/L solution.

*Answer:*

Molar mass of  $\text{NaNO}_3$  is 85.0 g/mol. Using the relationship above, solve for moles of solute:

$$\begin{aligned} \text{Moles} &= \text{concentration} \times L \\ &= 0.40 \frac{\text{mole}}{\cancel{\text{L}}} \times 0.050 \cancel{\text{L}} \\ &= 0.020 \text{ mole of } \text{NaNO}_3 \text{ required} \\ \text{Mass} &= 0.020 \cancel{\text{mole}} \times \frac{85.0 \text{ g}}{\cancel{\text{mol}}} \\ &= 1.7 \text{ g required} \end{aligned}$$





### SPECIFIC LEARNING OUTCOME

**C11-4-13:** Differentiate among, and give examples of, the use of various representations of concentration.

Include: grams per litre (g/L), % weight-weight (% w/w), % weight-volume (% w/v), % volume/volume (% v/v), parts per million (ppm), parts per billion (ppb), moles per litre (mol/L) (molarity)

(continued)

2. How much KOH would be required to make 200 mL of solution with a concentration of 2.6 mole/L?

Answer:

$$\text{Moles} = \text{concentration} \times \text{L}$$

$$= 2.6 \frac{\text{mole}}{\cancel{\text{L}}} \times 0.200 \cancel{\text{L}}$$

$$= 0.52 \text{ mole of KOH required}$$

$$\text{Mass} = 0.52 \cancel{\text{mole}} \times \frac{56.1 \text{ g}}{\cancel{\text{mol}}}$$

$$= 29.172 \text{ g or } 29 \text{ g (2 sig. figures) required}$$



### SUGGESTIONS FOR ASSESSMENT

#### Paper-and-Pencil Tasks

Students should simply be able to recognize the various concentration units and be able to explain what they mean.

Assessment would typically be done with paper-and-pencil exercises and quizzes.

### LEARNING RESOURCES LINKS



*Chemistry* (Chang 139, 491)

*Chemistry* (Zumdahl and Zumdahl 141)

*Chemistry: The Central Science* (Brown, et al. 498)

*Chemistry: Concepts and Applications* (Phillips, Strozak, and Wistrom 460)

*Chemistry: The Molecular Nature of Matter and Change* (Silberberg 501)

*Glencoe Chemistry: Matter and Change* (Dingrando, et al. 462)

*Introductory Chemistry: A Foundation* (Zumdahl 428)

*McGraw-Hill Ryerson Chemistry, Combined Atlantic Edition* (Mustoe, et al. 255)

*McGraw-Hill Ryerson Chemistry 11, Ontario Edition* (Mustoe, et al. 302)

*Nelson Chemistry 11, Ontario Edition* (Jenkins, et al. 281)

*Nelson Chemistry 12: College Preparation, Ontario Edition* (Davies, et al. 123)

*Prentice Hall Chemistry: Connections to Our Changing World* (LeMay, et al. 506)

**SKILLS AND ATTITUDES OUTCOMES**

**C11-0-U1:** Use appropriate strategies and skills to develop an understanding of chemical concepts.

*Examples: analogies, concept frames, concept maps, manipulatives, particulate representations, role-plays, simulations, sort-and-predict frames, word cycles...*

**C11-0-U2:** Demonstrate an understanding of chemical concepts.

*Examples: use accurate scientific vocabulary, explain concepts to others, compare and contrast concepts, apply knowledge to new situations and/or contexts, create analogies, use manipulatives...*

---

**NOTES**



## SPECIFIC LEARNING OUTCOME

**C11-4-14:** Solve problems involving calculation for concentration, moles, mass, and volume.

(1.0 hour)

SLO: C11-4-14

## SUGGESTIONS FOR INSTRUCTION

## Entry-Level Knowledge

Students have not received information on solution concentration prior to learning outcome C11-4-13.

## TEACHER NOTES

Provide students with sample problems that include the steps necessary to calculate the required variable. Students should also be provided with a good model of the solution to a typical problem involving calculation for concentration, moles, mass, and volume.

## Sample Calculation Problems

- Determine the *concentration* of a solution that contains 2.5 moles of solute dissolved in 5.0 L of solution.

*Answer:*

$$\text{Concentration} = \frac{\text{moles}}{\text{L}} = \frac{2.5 \text{ moles}}{5.0 \text{ L}} = 0.50 \text{ mol/L}$$

- What *volume* of solution would be required to make a 0.40 mol/L solution dissolving 0.10 moles of solute?

*Answer:*

$$\text{Volume (L)} = \frac{\text{moles}}{\text{concentration (mol/L}^{-1}\text{)}}$$

$$\text{Volume} = \frac{0.10 \text{ mol}}{0.40 \text{ mol/L}^{-1}}$$

The moles units cancel, leaving the answer in L.

$$\text{Volume} = 0.25 \text{ L (2 sig. figures)}$$

## General Learning Outcome Connections

**GLO C3:** Demonstrate appropriate problem-solving skills when seeking solutions to technological challenges.

**GLO D3:** Understand the properties and structures of matter, as well as various common manifestations and applications of the actions and interactions of matter.

## SKILLS AND ATTITUDES OUTCOMES

**C11-0-U1:** Use appropriate strategies and skills to develop an understanding of chemical concepts.

*Examples: analogies, concept frames, concept maps, manipulatives, particulate representations, role-plays, simulations, sort-and-predict frames, word cycles...*

**C11-0-U2:** Demonstrate an understanding of chemical concepts.

*Examples: use accurate scientific vocabulary, explain concepts to others, compare and contrast concepts, apply knowledge to new situations and/or contexts, create analogies, use manipulatives...*

3. Calculate the *mass* of ammonium hydroxide,  $\text{NH}_4\text{OH}$ , required to prepare 0.30 L of a 0.25 mol/L solution.

*Answer:*

$$\text{Mass} = \text{concentration} \times \text{litres}$$

$$= 0.25 \frac{\text{mol}}{\text{L}} \times 0.30 \cancel{\text{L}}$$

$$\text{Mass} = 0.075 \cancel{\text{mol}} \times \frac{35.0 \text{ g}}{\cancel{\text{mol}}}$$

$$= 2.6 \text{ g (2 sig. figures)}$$

4. Calculate the *concentration* of a solution if 44.0 g of lithium sulphate,  $\text{Li}_2\text{SO}_4$ , is dissolved in 0.400 L of solution.

*Answer:*

$$\text{Moles} = \frac{44.0 \cancel{\text{g}}}{109.98 \cancel{\text{g/mol}}}$$

$$= 0.400 \text{ mol}$$

$$C = \frac{\text{mol}}{\text{L}}$$

$$= \frac{0.400 \text{ mol}}{0.400 \text{ L}}$$

$$= 1.00 \text{ mol/L (3 sig. figures)}$$



## SPECIFIC LEARNING OUTCOME

**C11-4-14:** Solve problems involving calculation for concentration, moles, mass, and volume.

(continued)

5. What *volume* would be required to make a 0.400 moles/L solution containing 51.01 g of sodium nitrate,  $\text{NaNO}_{3(\text{aq})}$ ?

Answer:

$$\begin{aligned}\text{Moles} &= \frac{51.01 \cancel{\text{g}}}{85.01 \cancel{\text{g}}/\text{mol}} \\ &= 0.600 \text{ mol} \\ \text{Litres} &= \frac{\text{moles}}{\text{concentration}} \\ &= \frac{0.600 \cancel{\text{mol}}}{0.400 \cancel{\text{mol}}/\text{L}} \\ &= 1.50 \text{ L (3 sig. figures)}\end{aligned}$$



## SUGGESTIONS FOR ASSESSMENT

**Paper-and-Pencil Tasks**

Students should be able to solve problems involving calculation for concentration, moles, mass, and volume. Assessment would typically be done with paper-and-pencil exercises and tests.

## LEARNING RESOURCES LINKS



- Chemistry* (Zumdahl and Zumdahl 139, 141)  
*Chemistry: The Central Science* (Brown, et al. 136)  
*Chemistry: Concepts and Applications* (Phillips, Strozak, and Wistrom 462)  
*Chemistry: The Molecular Nature of Matter and Change* (Silberberg 502)  
*Glencoe Chemistry: Matter and Change* (Dingrando, et al. 464)  
*Introductory Chemistry: A Foundation* (Zumdahl 430)  
*McGraw-Hill Ryerson Chemistry, Combined Atlantic Edition* (Mustoe, et al. 266)  
*McGraw-Hill Ryerson Chemistry 11, Ontario Edition* (Mustoe, et al. 313)  
*Nelson Chemistry 11, Ontario Edition* (Jenkins, et al. 283)  
*Nelson Chemistry 12: College Preparation, Ontario Edition* (Davies, et al. 126)  
*Prentice Hall Chemistry: Connections to Our Changing World* (LeMay, et al. 507)

**SKILLS AND ATTITUDES OUTCOMES**

**C11-0-U1:** Use appropriate strategies and skills to develop an understanding of chemical concepts.

*Examples: analogies, concept frames, concept maps, manipulatives, particulate representations, role-plays, simulations, sort-and-predict frames, word cycles...*

**C11-0-U2:** Demonstrate an understanding of chemical concepts.

*Examples: use accurate scientific vocabulary, explain concepts to others, compare and contrast concepts, apply knowledge to new situations and/or contexts, create analogies, use manipulatives...*

---

**NOTES**



## SPECIFIC LEARNING OUTCOME

**C11-4-15:** Prepare a solution, given the amount of solute (in grams) and the volume of solution (in millilitres), and determine the concentration in moles/litre.

(1.0 hour)

SLO: C11-4-15

## SUGGESTIONS FOR INSTRUCTION

**Entry-Level Knowledge**

Students have had no experience at accurately preparing solutions. Learning outcome C11-4-13 introduced concentration units and learning outcome C11-4-14 required students to solve concentration problems.

**TEACHER NOTES**

For this learning outcome, prepare solutions that could be used for learning outcome C11-4-17, where students prepare a dilution from a solution of known concentration.

*Examples:*

Prepare 0.10 mol/L solutions of

- copper(II) sulphate,  $\text{CuSO}_4$
- cobalt(II) chloride,  $\text{CoCl}_2$
- sodium chloride,  $\text{NaCl}$

**Laboratory Procedure for Preparing Solutions**

The focus of this lab activity should be on lab safety, accuracy, and precision. Wherever possible, students should use volumetric flasks to make the solutions.

The procedure could be as follows:

Measure out a given amount of solute onto a pre-weighed piece of paper. Then, *quantitatively* transfer the solid to the appropriate volumetric flask using a glass funnel and a squirt bottle filled with distilled or deionized water. The water is used to ensure that all the solute has been transferred to the flask. Wash the sides of the flask with the water. Fill the flask to approximately two-thirds full. Then, dissolve the solute completely by carefully swirling the flask. Carefully increase the level of the solution with water until the correct level is reached. (**Note:** Students should at first use an eyedropper to add the final amount of water. Once students are more proficient, they could use the squirt bottle to add the final volume.) Once the

**General Learning Outcome Connections**

- GLO C1:** Recognize safety symbols and practices related to scientific and technological activities and to their daily lives, and apply this knowledge in appropriate situations.
- GLO C2:** Demonstrate appropriate scientific inquiry skills when seeking answers to questions.
- GLO C3:** Demonstrate appropriate problem-solving skills when seeking solutions to technological challenges.

**SKILLS AND ATTITUDES OUTCOMES**

**C11-0-S4:** Select and use scientific equipment appropriately and safely.

*Examples: volumetric glassware, balance, thermometer...*

**C11-0-S6:** Estimate and measure accurately using Système International (SI) and other standard units.

*Include: SI conversions, significant figures*

correct amount of water has been added, insert a stopper into the flask. Shake the contents of the flask to ensure the homogeneity of the resulting solution.

**Performance Task: Laboratory Skills**

*Example:*

Prepare 100.0 mL of a solution using 5.85 g of sodium chloride, NaCl. What would be the concentration of the prepared solution?

*Calculation:*

$$\text{Moles of NaCl} = \frac{5.85 \text{ g}}{58.5 \text{ g} \cdot \text{mol}^{-1}}$$

$$\text{Moles} = 0.100 \text{ mol}$$

$$\begin{aligned} \text{Concentration} &= \frac{\text{moles}}{\text{L}} \\ &= \frac{0.100 \text{ mol}}{0.1000 \text{ L}} \\ &= 1.00 \text{ mol/L (3 sig. figures)} \end{aligned}$$

*Procedure:*

1. Place a small piece of smooth paper on the balance and carefully weigh it. Record the mass of the paper.
2. Next, tap and rotate the container of NaCl to get 5.85 g. Remember, if too much is added, turn off the balance or arrest the pan and carefully remove more than you think you need to. To avoid contamination, DO NOT put the removed NaCl back into the original container. Turn on the balance and continue to add NaCl until the correct mass is obtained.
3. Using a 100 mL volumetric flask, carefully place a clean glass filter funnel into the neck of the flask, making sure that the apparatus does not fall over. Carefully pour the NaCl from the weighing paper into the funnel. Gently wash the solid through the funnel using a squeeze bottle containing either distilled or deionized water. Remove the funnel and wash its sides with the same water.
4. Remove the funnel and fill the flask to approximately two-thirds of its volume. Stopper or cover the flask with *parafilm* or by some other means.



**SPECIFIC LEARNING OUTCOME**

**C11-4-15:** Prepare a solution, given the amount of solute (in grams) and the volume of solution (in millilitres), and determine the concentration in moles/litre.

(continued)

- Carefully swirl the flask until all the solid has dissolved. It is crucial to ensure that all the solid is completely transferred. Add distilled water to the flask until the correct volume has been reached.
- Shake the contents of the flask to ensure the homogeneity of the resulting solution.

**Laboratory Activity**

Have students do a lab investigation to determine the concentration of a given sample of solution. Part of the investigation involves designing the procedures required to solve the problem.

**SUGGESTIONS FOR ASSESSMENT****Rubrics/Checklists**

For the performance lab, create a short skill-based rubric to assess a predetermined set of skills. See Appendix 10 for a variety of rubrics and checklists that can be used for self-assessment, peer assessment, and teacher assessment.

**Laboratory Reports**

The lab activities outlined for this learning outcome could be assessed as formal lab reports using the Laboratory Report Outline or the Laboratory Report Format (see SYSTH 11.38, 14.12) or by using questions and answers from the data collected from the activities.

**Journal Writing**

Have students comment on the source of errors for the lab activities. Sources of errors could include

- massing errors
- mass loss during transfers
- incorrect volume added

**Paper-and-Pencil Tasks**

Students could be asked to describe the correct order of the procedure to prepare a solution similar to the one outlined in the Suggestions for Instruction for this learning outcome. They could be also asked to discuss the relative importance of the various errors.

#### SKILLS AND ATTITUDES OUTCOMES

**C11-0-S4:** Select and use scientific equipment appropriately and safely.

*Examples: volumetric glassware, balance, thermometer...*

**C11-0-S6:** Estimate and measure accurately using Système International (SI) and other standard units.

*Include: SI conversions, significant figures*

---

#### LEARNING RESOURCES LINKS

---



*Chemistry (Zumdahl and Zumdahl 144)*

*Chemistry: The Central Science (Brown, et al. 135)*

*Chemistry: Concepts and Applications (Phillips, Strozak, and Wistrom 461)*

*Chemistry: The Molecular Nature of Matter and Change (Silberberg 116)*

*Glencoe Chemistry: Matter and Change (Dingrando, et al. 466)*

*Introductory Chemistry: A Foundation (Zumdahl 433)*

*McGraw-Hill Ryerson Chemistry, Combined Atlantic Edition (Mustoe, et al. 271)*

*McGraw-Hill Ryerson Chemistry 11, Ontario Edition (Mustoe, et al. 319)*

*Nelson Chemistry 11, Ontario Edition (Jenkins, et al. 300)*

*Prentice Hall Chemistry: Connections to Our Changing World (LeMay, et al. 508)*

#### **Laboratory Activity**

*Nelson Chemistry 11, Ontario Edition (Jenkins, et al. 301)*



## SPECIFIC LEARNING OUTCOME

**C11-4-16:** Solve problems involving the dilution of solutions.

Include: dilution of stock solutions, mixing common solutions with different volumes and concentrations

(1.5 hours)

SLO: C11-4-16

### SUGGESTIONS FOR INSTRUCTION

#### Entry-Level Knowledge

Other than being able to solve concentration problems (learning outcome C11-4-14), students will have no prior knowledge of solving dilution problems.

#### TEACHER NOTES

In solving problems involving the dilution of solutions, students should learn to recognize that when a dilution occurs, the number of moles remains constant. Many teachers and texts use the following general formula or modification of the formula for solving these problems:

$$C_1 \times V_1 = C_2 \times V_2$$

When students are given this relationship without a careful explanation, they may become confused. Teachers may wish to use this formula only after students can solve problems without it. Many students will come up with this relationship themselves.

#### Sample Dilution Problems

1. Calculate the final concentration when 75.0 mL of water is added to 25.0 mL of an 8.00 mol/L of HCl.

*Answer:*

$$\text{Moles (of original solution)} = \frac{\text{moles}}{\text{L}} \times \text{L}$$

$$\text{Moles} = 8.00 \frac{\text{moles}}{\cancel{\text{L}}} \times 0.0250 \cancel{\text{L}}$$

$$\text{Moles} = 0.200 \text{ moles}$$

#### General Learning Outcome Connections

**GLO C3:** Demonstrate appropriate problem-solving skills when seeking solutions to technological challenges.

**GLO D3:** Understand the properties and structures of matter, as well as various common manifestations and applications of the actions and interactions of matter.

## SKILLS AND ATTITUDES OUTCOMES

**C11-0-U1:** Use appropriate strategies and skills to develop an understanding of chemical concepts.

*Examples: analogies, concept frames, concept maps, manipulatives, particulate representations, role-plays, simulations, sort-and-predict frames, word cycles...*

**C11-0-U2:** Demonstrate an understanding of chemical concepts.

*Examples: use accurate scientific vocabulary, explain concepts to others, compare and contrast concepts, apply knowledge to new situations and/or contexts, create analogies, use manipulatives...*

Since only water is being added, the moles of solute are constant and we can write:

$$\text{Concentration (of final solution)} = \frac{\text{moles}}{\text{L (final volume)}}$$

$$C = \frac{0.200 \text{ moles}}{(0.025 + 0.075) \text{ L}}$$

$$C = 2.00 \text{ moles/L}$$

2. What volume of water must be added to 150.0 mL of a 5.00 mol/L solution of NaOH (sodium hydroxide) to make a 2.00 mol/L solution?

This type of problem is very common in most research laboratories, hospital laboratories, and so on. Technicians will often prepare stock solutions to be diluted when needed.

*Answer:*

$$\text{Initial solution moles} = C \times V$$

$$= \frac{5.00 \text{ mol}}{\cancel{\text{L}}} \times 0.150 \cancel{\text{ L}}$$

$$= 0.750 \text{ mol}$$

Since the moles will be constant again, we can use initial moles to find the final volume of water.

$$\text{Final volume} = \frac{\text{final moles (same as initial)}}{\text{final concentration}}$$

$$= \frac{0.750 \cancel{\text{ mol}}}{2.00 \cancel{\text{ mol}} \cdot \text{L}^{-1}}$$

$$= 0.375 \text{ L}$$

The volume added would be  $375 - 150 \text{ mL} = 225 \text{ mL}$

Another option is doing a calculation with stock solutions.



## SPECIFIC LEARNING OUTCOME

**C11-4-16:** Solve problems involving the dilution of solutions.

Include: dilution of stock solutions, mixing common solutions with different volumes and concentrations

(continued)

3. Calculate the volume of stock 18.0 mol/L  $\text{H}_2\text{SO}_4$  (sulphuric acid) that would be required to make 300.0 mL of 3.00 mol/L solution.

*Answer:*

$$\text{Moles (in final solution)} = \frac{\text{moles}}{\text{L}} (\text{final}) \times \text{L (final)}$$

$$\text{Moles} = 3.00 \frac{\text{moles}}{\cancel{\text{L}}} \times 0.300 \cancel{\text{L}}$$

$$\text{Moles} = 0.900 \text{ mol}$$

Since only water is being added, the moles of solute are constant and we can write:

$$\text{Volume (of stock solution)} = \frac{\text{moles (initial)}}{\text{concentration (initial)}}$$

$$\text{Volume} = \frac{0.900 \cancel{\text{ moles}}}{18.0 \cancel{\text{ moles/L}}}$$

$$\text{Volume} = 0.0500 \text{ L}$$

The dilution would be made by adding 50.0 mL of 18.0 mol/L stock solution of  $\text{H}_2\text{SO}_4$  to a 300.0 mL volumetric flask and adding the appropriate volume of distilled water to the full mark of the flask.

4. If 45.0 mL of stock HCl was required to make 150.0 mL of a 3.48 mol/L solution, calculate the concentration of the original stock solution.

*Answer:*

We can calculate the moles that are constant between the final solution and the original stock solution.

Final moles = final concentration  $\times$  final volume

$$= \frac{3.48 \text{ mol}}{\cancel{\text{L}}} \times 0.1500 \cancel{\text{L}}$$

$$= 0.522 \text{ mol}$$

Since this number of moles was taken from the original stock HCl solution, we can now calculate the original concentration.

## SKILLS AND ATTITUDES OUTCOMES

**C11-0-U1:** Use appropriate strategies and skills to develop an understanding of chemical concepts.

*Examples: analogies, concept frames, concept maps, manipulatives, particulate representations, role-plays, simulations, sort-and-predict frames, word cycles...*

**C11-0-U2:** Demonstrate an understanding of chemical concepts.

*Examples: use accurate scientific vocabulary, explain concepts to others, compare and contrast concepts, apply knowledge to new situations and/or contexts, create analogies, use manipulatives...*

$$\begin{aligned}\text{Final concentration} &= \frac{\text{initial moles (same as final)}}{\text{initial volume}} \\ &= \frac{0.522 \text{ mol}}{0.450 \text{ L}} \\ &= 11.6 \text{ mol/L}\end{aligned}$$

The initial concentration of the stock HCl acid = 11.6 mol/L.

**Note:** The second type of dilution problem involves solutions having the same solute and solvent, and are mixed together.

5. What would be the final volume and concentration if 50.0 mL of 0.250 mol/L NaOH is added to 75.0 mL of 0.450 mol/L solution of NaOH?

*Answer:*

Students should first be asked what solution characteristics are the same and what characteristics are different before and after the solutions are mixed.

- Volumes are different.
- Concentrations are different.
- Solute is the same.
- Solvent is the same.

There should be no reaction, so moles of each solution should be additive.

We should, therefore, calculate the moles of each solution, add them, and divide by the new total volume according to  $C = \text{moles/litres}$ .

Moles of solution 1 = concentration #1 x volume #1

$$\begin{aligned}&= \frac{0.250 \text{ mol}}{\cancel{\text{L}}} \times 0.050 \cancel{\text{ L}} \\ &= 0.0125 \text{ mol}\end{aligned}$$

Moles of solution 2 = concentration #2 x volume #2

$$\begin{aligned}&= \frac{0.450 \text{ mol}}{\cancel{\text{L}}} \times 0.0750 \cancel{\text{ L}} \\ &= 0.03375 \text{ mol}\end{aligned}$$

**SPECIFIC LEARNING OUTCOME****C11-4-16:** Solve problems involving the dilution of solutions.

Include: dilution of stock solutions, mixing common solutions with different volumes and concentrations

*(continued)*

$$\begin{aligned} \text{Final concentration} &= \frac{\text{moles 1} + \text{moles 2}}{\text{volume 1} + \text{volume 2}} \\ &= \frac{0.0125 \text{ mol} + 0.03375 \text{ mol}}{0.050 \text{ L} + 0.0750 \text{ L}} \\ &= 0.370 \text{ mol/L} \end{aligned}$$

This answer seems reasonable, as the initial volumes of the two solutions are similar and the final concentration is between the concentrations of the two original solutions.

**SUGGESTIONS FOR ASSESSMENT****Paper-and-Pencil Tasks**

Solving problems involving the dilution of solutions would usually be assessed with exercises and quizzes.

**LEARNING RESOURCES LINKS***Chemistry* (Chang 141)*Chemistry* (Zumdahl and Zumdahl 145)*Chemistry: The Central Science* (Brown, *et al.* 137)*Glencoe Chemistry: Matter and Change* (Dingrando, *et al.* 467)*Introductory Chemistry: A Foundation* (Zumdahl 434)*McGraw-Hill Ryerson Chemistry, Combined Atlantic Edition* (Mustoe, *et al.* 272)*McGraw-Hill Ryerson Chemistry 11, Ontario Edition* (Mustoe, *et al.* 320)*Nelson Chemistry 11, Ontario Edition* (Jenkins, *et al.* 302)*Nelson Chemistry 12: College Preparation, Ontario Edition* (Davies, *et al.* 134)

**SKILLS AND ATTITUDES OUTCOMES**

**C11-0-U1:** Use appropriate strategies and skills to develop an understanding of chemical concepts.

*Examples: analogies, concept frames, concept maps, manipulatives, particulate representations, role-plays, simulations, sort-and-predict frames, word cycles...*

**C11-0-U2:** Demonstrate an understanding of chemical concepts.

*Examples: use accurate scientific vocabulary, explain concepts to others, compare and contrast concepts, apply knowledge to new situations and/or contexts, create analogies, use manipulatives...*

---

**NOTES**





## SPECIFIC LEARNING OUTCOME

C11-4-17: Perform a dilution from a solution of known concentration.

(1.0 hour)

SLO: C11-4-17

## SUGGESTIONS FOR INSTRUCTION

## Entry-Level Knowledge

Students would most likely not have done a dilution procedure, although they will have prepared solutions and used volumetric glassware (learning outcome C11-4-15).

## TEACHER NOTES

Have students use one of the solutions prepared in the development of learning outcome C11-4-15 to perform a dilution. Ask students to design the procedure for this task. Check the procedure and have students make the necessary revisions.

Students should use volumetric flasks and pipettes whenever possible. The alternative would be to use graduated cylinders and pipettes.

## Procedure for Performing a Serial Dilution

There are many ways to conduct a *serial dilution*. Essentially, repeated aliquots are taken from each successive dilution.

## Performance Task: Laboratory Skills

The suggested procedure for the dilution of 1.00 mol/L solution to a 0.001 mol/L solution is as follows:

1. Carefully pipette 10.0 mL of stock solution and dispense it into a clean volumetric flask.
2. Add water until the flask is approximately two-thirds full, and mix the solution.
3. Carefully add water until it exactly reaches the 100.0 mL mark of the volumetric flask.
4. The flask can now be stoppered and the solution mixed thoroughly.

## General Learning Outcome Connections

**GLO C6:** Employ effective communication skills and use information technology to gather and share scientific and technological ideas and data.

**GLO D3:** Understand the properties and structures of matter, as well as various common manifestations and applications of the actions and interactions of matter.

**SKILLS AND ATTITUDES OUTCOMES**

**C11-0-U1:** Use appropriate strategies and skills to develop an understanding of chemical concepts.

*Examples: analogies, concept frames, concept maps, manipulatives, particulate representations, role-plays, simulations, sort-and-predict frames, word cycles...*

**C11-0-R1:** Synthesize information obtained from a variety of sources.

Include: print and electronic sources, specialists, other resource people

The concentration of this solution will be:

$$\frac{10 \text{ mL}}{100 \text{ mL}} \times 1.00 \text{ mol/L} = 0.100 \text{ mol/L}$$

This becomes the new “stock” solution, and the process is repeated:

1. Carefully pipette 10.0 mL of stock solution and then dispense into a clean volumetric flask.
2. Add water to approximately two-thirds of the flask volume and then mix the solution.
3. Carefully add water until it exactly reaches the 100.0 mL mark of the volumetric flask.
4. The flask can now be stoppered and the solution mixed thoroughly.

The concentration of this solution will be:

$$\frac{10 \text{ mL}}{100 \text{ mL}} \times 0.100 \text{ mol/L} = 0.0100 \text{ mol/L}$$

This becomes the new “stock” solution, and the process is repeated.

The concentration of this solution will be:

$$\frac{10 \text{ mL}}{100 \text{ mL}} \times 0.0100 \text{ mol/L} = 0.00100 \text{ mol/L}$$

Serial dilutions are used extensively in microbiology where lab technicians dilute stock solution of media for the specialized growth of bacteria.



## SUGGESTIONS FOR ASSESSMENT

### Rubrics/Checklists

See Appendix 10 for a variety of rubrics and checklists that can be used for self-assessment, peer assessment, and teacher assessment.

For the performance lab, teachers will be carefully watching students for correct procedure. A performance rubric from Appendix 10 can be used to assess student success in this lab activity.



**SPECIFIC LEARNING OUTCOME**

**C11-4-17:** Perform a dilution from a solution of known concentration.

(continued)

---

**Laboratory Reports**

The lab activities outlined for this learning outcome could be assessed as formal lab reports using the Laboratory Report Outline or the Laboratory Report Format (see *SYSTH* 11.38, 14.12) or by using questions and answers from the data collected from the activities.

**LEARNING RESOURCES LINKS**

---



*Glencoe Chemistry: Matter and Change* (Dingrando, et al. 467)

*Nelson Chemistry 11, Ontario Edition* (Jenkins, et al. 305)

*Nelson Chemistry 12: College Preparation, Ontario Edition* (Davies, et al. 134)

**SKILLS AND ATTITUDES OUTCOMES**

**C11-0-U1:** Use appropriate strategies and skills to develop an understanding of chemical concepts.

*Examples: analogies, concept frames, concept maps, manipulatives, particulate representations, role-plays, simulations, sort-and-predict frames, word cycles...*

**C11-0-R1:** Synthesize information obtained from a variety of sources.

Include: print and electronic sources, specialists, other resource people

---

**NOTES**

**SPECIFIC LEARNING OUTCOME**

**C11-4-18:** Describe examples of situations where solutions of known concentration are important.

*Examples: pharmaceutical preparations, administration of drugs, aquaria, swimming-pool disinfectants, gas mixes for scuba, radiator antifreeze...*

(1.5 hours)

SLO: C11-4-18

**SUGGESTIONS FOR INSTRUCTION****Entry-Level Knowledge**

Students will likely have prior experience with some of the examples identified in learning outcome C11-4-18. It is hoped that students will be able to provide some of their own examples.

**Assessing Prior Knowledge**

Check for student understanding of prior knowledge and review as necessary. Prior knowledge can be reviewed and/or assessed by using any of the KWL strategies (e.g., Concept Map, Knowledge Chart, Think-Pair-Share—see *SYSTH*, Chapter 9).

**TEACHER NOTES**

Many examples of solutions can be found around most households. The concentration information for the solutions is given in a variety of ways.

**Products Found at Home**

It would be beneficial to students if they were able to collect their own samples of solutions among the domestic products found at home. Nevertheless, some examples are provided below as guidance. Students could augment and refine the information provided here by obtaining additional information from the labelling on products. The examples listed here identify the manner in which concentrations vary widely in their use of units or volumetric data.

**General Learning Outcome Connections**

- GLO A3:** Distinguish critically between science and technology in terms of their respective contexts, goals, methods, products, and values.
- GLO A5:** Recognize that science and technology interact with and advance one another.
- GLO B2:** Recognize that scientific and technological endeavours have been and continue to be influenced by human needs and the societal context of the time.
- GLO B4:** Demonstrate knowledge of and personal consideration for a range of possible science- and technology-related interests, hobbies, and careers.

**SKILLS AND ATTITUDES OUTCOMES**

**C11-0-R1:** Synthesize information obtained from a variety of sources.

Include: print and electronic sources, specialists, other resource people

**C11-0-R2:** Evaluate information obtained to determine its usefulness for information needs.

*Examples: scientific accuracy, reliability, currency, relevance, balance of perspectives, bias...*

**C11-0-R3:** Quote from or refer to sources as required and reference information sources according to an accepted practice.

**C11-0-R5:** Communicate information in a variety of forms appropriate to the audience, purpose, and context.

---

*Examples:*

- Vicks® VapoRub®: camphor 4.73% w/w
- Curél® moisturizer: glycerine 12% w/w
- rubbing alcohol: 40% v/v
- Aquafina® bottled water: fluoride ion, 0.3 ppm
- Roundup®: 7g/L glyphosate
- liquid ant killer: 5.4% w/v borax

**Pharmacy Preparations**

Most ointments exceeding certain concentrations are dispensed by a qualified pharmacist.

*Example:*

- medicated dermatitis cream: 0.5% w/w betamethasone (an over-the-counter equivalent has a 0.1% w/w concentration)

**Dental Surgery**

Dentists will often use epinephrine in anaesthetic as a vasodilator to ensure that the anaesthetic is not flushed as rapidly from the tissues of the oral cavity.

*Example:*

- xylocaine hydrochloride 2% with 1:50,000 epinephrine (20 ppm)

**Automobile Antifreeze***Example:*

- For one brand of commercial antifreeze/coolant, the container lists the following concentrations: For protection from freezing down to  $-52^{\circ}\text{C}$ , dilute to a 60% v/v solution; and for further protection to  $-64^{\circ}\text{C}$ , dilute to a 70% v/v solution.

**SPECIFIC LEARNING OUTCOME**

**C11-4-18:** Describe examples of situations where solutions of known concentration are important.

*Examples: pharmaceutical preparations, administration of drugs, aquaria, swimming-pool disinfectants, gas mixes for scuba, radiator antifreeze...*

(continued)

**Fish Aquaria**

Nitrogen as ammonia in fish tanks must be carefully balanced to ensure fish remain healthy. The following table provides recommended concentrations in mg/L (ppm) of ammonia at various pH values.

pH	20°C	25°C
6.5	15.4	11.1
7.0	5.0	3.6
7.5	1.6	1.2
8.0	0.5	0.4
8.5	0.2	0.1

**Reference:** The Fishtank Crew: <<http://pcpages.com/fish/nitrogen1.html>>

**Swimming-Pool Solutions**

The chlorine in swimming pools is carefully controlled as a disinfectant against bacteria and other micro-organisms.

*Example:*

- free chlorine,  $\text{Cl}_2$ , is usually kept between 1.0 and 2.5 ppm.



The use of chlorine as a disinfectant has come under scrutiny lately as a potential human biohazard. For background information, see the following website:

AZCO Industries Limited: <<http://www.azco.bc.ca/info/chlorine.htm>>

**Recreational Scuba**

When a number of gases are placed together in the same container, the resulting system could be called either a gas mixture or a solution of miscible gases blended together. Scuba diving has become both safer and more complex with the use of Nitrox mixtures in which the percentage of oxygen in air is increased and the percentage of nitrogen is decreased. By reducing the amount of nitrogen, divers are able to make longer dives to the same depth. Specialized instruction and certification is required for divers to use Nitrox mixtures. Excess nitrogen dissolved in the blood supply is the causal factor in *decompression sickness*, also known as *the bends*. The physiological effects of this situation often have outward manifestations such as severe muscle cramping and delirium, hence the reference to *bending*.

**SKILLS AND ATTITUDES OUTCOMES**

- C11-0-R1:** Synthesize information obtained from a variety of sources.  
Include: print and electronic sources, specialists, other resource people
- C11-0-R2:** Evaluate information obtained to determine its usefulness for information needs.  
*Examples: scientific accuracy, reliability, currency, relevance, balance of perspectives, bias...*
- C11-0-R3:** Quote from or refer to sources as required and reference information sources according to an accepted practice.
- C11-0-R5:** Communicate information in a variety of forms appropriate to the audience, purpose, and context.

The following table, illustrating examples of gas mixtures, provides the maximum time permissible, for a particular depth, before decompression is required on ascent. EAN is Enriched Air Nitrox. EAN 32 is 32% O<sub>2</sub> as opposed to the normal 21% O<sub>2</sub> in air.

<b>A Comparison of Dive Times for Various Gas Mixtures</b> (Dive Times in Minutes)			
<b>Depth (ft.)</b>	<b>Air</b>	<b>EAN 32</b>	<b>EAN 36</b>
50	80	200	200
60	55	100	100
70	45	60	60
80	35	50	60
90	25	40	50
100	22	30	40
110	15	25	30
120	12	25	n/a

**Reference:** Oakley, Burks II. *Nitrox Scuba Diving*. University of Illinois at Springfield. 30 April 2000. <<http://www.online.uillinois.edu/oakley/nitrox.html>>.

**SUGGESTIONS FOR ASSESSMENT**

This learning outcome illustrates another valid reason for students to study chemistry. Students should be able to provide examples of solutions found in their daily lives.

**Rubrics/Checklists**

See Appendix 10 for a variety of rubrics and checklists that can be used for self-assessment, peer assessment, and teacher assessment.



**SPECIFIC LEARNING OUTCOME**

**C11-4-18:** Describe examples of situations where solutions of known concentration are important.

*Examples: pharmaceutical preparations, administration of drugs, aquaria, swimming-pool disinfectants, gas mixes for scuba, radiator antifreeze...*

(continued)

**Research Reports**

If there is time for students to collect further examples of situations where different solutions are found, the information collected could be presented as

- written reports
- oral presentations
- bulletin board displays

**Visual Displays**

Depending on the information collected, students could present the material using

- posters
- pamphlets
- bulletin boards
- models

Each of these presentation styles could be assessed using an appropriate rubric created with students prior to the assignment. Samples of presentation rubrics are provided in Appendix 10 of this document.

**LEARNING RESOURCES LINKS**

*Chemistry: The Central Science* (Brown, *et al.* 137 – the aura of gold)

*Chemistry: Concepts and Applications* (Phillips, Strozak, and Wistrom 468 – reverse osmosis)

*Chemistry: The Molecular Nature of Matter and Change* (Silberberg 503 – pheromones, 512 – uses of colligative properties)

*Glencoe Chemistry: Matter and Change* (Dingrando, *et al.* 463 – aquarium salt concentration, 468 – fluoridation of water)

*McGraw-Hill Ryerson Chemistry 11, Ontario Edition* (Mustoe, *et al.* 302 – MSDS of household products, 306 – mass/mass alloys)

*Nelson Chemistry 11, Ontario Edition* (Jenkins, *et al.* 281 – consumer products)

*Nelson Chemistry 12: College Preparation, Ontario Edition* (Davies, *et al.* 123)

*Prentice Hall Chemistry: Connections to Our Changing World* (LeMay, *et al.* 504 – aquaria concentrations)

**SKILLS AND ATTITUDES OUTCOMES**

**C11-0-R1:** Synthesize information obtained from a variety of sources.

Include: print and electronic sources, specialists, other resource people

**C11-0-R2:** Evaluate information obtained to determine its usefulness for information needs.

*Examples: scientific accuracy, reliability, currency, relevance, balance of perspectives, bias...*

**C11-0-R3:** Quote from or refer to sources as required and reference information sources according to an accepted practice.

**C11-0-R5:** Communicate information in a variety of forms appropriate to the audience, purpose, and context.

---

**NOTES**

**SPECIFIC LEARNING OUTCOME**

**C11-4-19:** Describe the process of treating a water supply, identifying the allowable concentrations of metallic and organic species in water suitable for consumption.

(1.0 hour)

SLO: C11-4-19

**SUGGESTIONS FOR INSTRUCTION****Entry-Level Knowledge**

Many rural students may be familiar with the processes associated with water treatment due to their proximity to a community water-treatment plant.

**Assessing Prior Knowledge**

Check for student understanding of prior knowledge and review as necessary. Prior knowledge can be reviewed and/or assessed by using any of the KWL strategies (e.g., Concept Map, Knowledge Chart, Think-Pair-Share—see *SYSTH*, Chapter 9).

**TEACHER NOTES**

The intent of learning outcome C11-4-19 is for students to gain an appreciation of the methods used to treat their own local water supply. Discussion will undoubtedly include the local source for water, water treatment, water purity, and the shortage of clean potable water for much of the world's population.

**General Learning Outcome Connections**

- GLO A5:** Recognize that science and technology interact with and advance one another.
- GLO B1:** Describe scientific and technological developments—past and present—and appreciate their impact on individuals, societies, and the environment, both locally and globally.
- GLO B3:** Identify the factors that affect health, and explain the relationships among personal habits, lifestyle choices, and human health, both individual and social.
- GLO C2:** Demonstrate appropriate scientific inquiry skills when seeking answers to questions.
- GLO C4:** Demonstrate appropriate critical thinking and decision-making skills when choosing a course of action based on scientific and technological information.

**SKILLS AND ATTITUDES OUTCOMES**

**C11-0-S9:** Draw a conclusion based on the analysis and interpretation of data.

Include: cause-and-effect relationships, alternative explanations, supporting or rejecting a hypothesis or prediction

**C11-0-D1:** Identify and explore a current STSE issue.

Examples: clarify what the issue is, identify different viewpoints and/or stakeholders, research existing data/information...

**C11-0-D2:** Evaluate implications of possible alternatives or positions related to an STSE issue.

Examples: positive and negative consequences of a decision, strengths and weaknesses of a position...

**C11-0-D3:** Recognize that decisions reflect values and consider their own values and those of others when making a decision.

Examples: being in balance with nature, generating wealth, respecting personal freedom...

**C11-0-A1:** Demonstrate confidence in their ability to carry out investigations in chemistry and to address STSE-related issues.

**World Water Shortages**

The following information regarding the world reservoirs of water may provide a starting point for a discussion about world water shortages.

The Earth's Water Supply		
Reservoir	Volume (km <sup>3</sup> )	Percent of Total Time
Atmospheric moisture expressed as water	15 x 10 <sup>3</sup>	0.001
Rivers and lakes	510 x 10 <sup>3</sup>	0.036
Groundwater	5100 x 10 <sup>3</sup>	0.365
Glacial and other land ice	22,950 x 10 <sup>3</sup>	1.641
Oceanic water and sea ice	1,370,323 x 10 <sup>3</sup>	97.957
Total	1,398,898 x 10 <sup>3</sup>	100

**The Earth's Water Supply:** Reproduced from page 33 of *Fundamentals of Oceanography* by Alison B. Duxbury and Alyn C. Duxbury. Copyright © 1996 The McGraw-Hill Companies, Inc.

**Water-Treatment Processes**

Water-treatment plants use a variety of treatment processes, including

- settling tanks
- filtration
- addition of chemicals
- aeration
- chlorination
- fluorination

**SPECIFIC LEARNING OUTCOME**

**C11-4-19:** Describe the process of treating a water supply, identifying the allowable concentrations of metallic and organic species in water suitable for consumption.

(continued)

If students use well water, they should also explore the process by which their own water is treated. Possible treatments include

- distillation
- use of water softeners
- reverse osmosis



For an explanation and a series of questions related to domestic reverse osmosis techniques, see selected learning resources, consult a local water supply firm, or see the information provided on the Pure Water Products website:

<<http://www.pwgazette.com/rofaq.htm>>.

Ideally, the class will be able to visit a local treatment plant where students can see water treatment first-hand. Prior to the tour, provide students with a working knowledge of water-treatment processes so they can ask informed questions while on the tour. Class reports of the tour could be made either orally or in writing.

The Manitoba Water Stewardship Branch website (at <<http://www.gov.mb.ca/waterstewardship/odw/index.html>>) provides a map of Manitoba communities with the location of their water supply and treatment facilities. By accessing this website, students can locate the water-treatment plant that is nearest to their community.

**Research Activity**

Have students research their own water supply and identify where and how it is treated. The Manitoba Water Stewardship Branch website provides local information. The Internet and print texts will provide a wealth of general information about water-treatment processes. Text references can be found in the Learning Resources Links cited for this learning outcome. Both the online and print resources provide diagrams of treatment plants that students could recreate for display purposes.

**STSE Decision-Making Issue**

This learning outcome provides another opportunity for students to use the research they have collected to make STSE decisions regarding their own water supply.

**SKILLS AND ATTITUDES OUTCOMES**

**C11-0-S9:** Draw a conclusion based on the analysis and interpretation of data.

Include: cause-and-effect relationships, alternative explanations, supporting or rejecting a hypothesis or prediction

**C11-0-D1:** Identify and explore a current STSE issue.

Examples: clarify what the issue is, identify different viewpoints and/or stakeholders, research existing data/information...

**C11-0-D2:** Evaluate implications of possible alternatives or positions related to an STSE issue.

Examples: positive and negative consequences of a decision, strengths and weaknesses of a position...

**C11-0-D3:** Recognize that decisions reflect values and consider their own values and those of others when making a decision.

Examples: being in balance with nature, generating wealth, respecting personal freedom...

**C11-0-A1:** Demonstrate confidence in their ability to carry out investigations in chemistry and to address STSE-related issues.

---

**Activities**

Students could participate in the following activities:

1. **Role-Play:** Students hold a community town-hall meeting about water safety/treatment. They could play the roles of police officers, game wardens, local business owners, reporters from local newspapers, delegates from recreational clubs around town, and so on.
2. **Debate:** Students debate the cost versus effectiveness of water treatment.
3. **Court Case:** The class stages a court case over animals being poisoned by a local big business contaminating the local water supply.

Similar activities could be done for water softening as for water treatment.

**STSE Issues: Exploring Bottled Water Issues**

Worldwide, the bottled water industry was estimated to generate sales of 50 to 100 billion dollars per year as of 2005, and this constitutes about 150 billion litres consumed. That is the equivalent of a freshwater lake that contains 150,000,000 m<sup>3</sup> of water. According to the Beverage Marketing Corporation in the United States, North Americans drink an average of 400 mL of bottled water per day/person.

Provide students with the opportunity to investigate the following:

1. Sample a drinking water supply from home, or the school, and have it tested for amounts of dissolved solids and available chlorine (if treated).
2. Compare these results with those from a sample of bottled water that has had its labelling removed. Compare and contrast the results of the chemistry of these samples.
3. In past years, Winnipeg's water supply from Shoal Lake in the Whiteshell of Manitoba has consistently ranked among the world's top 10 in terms of quality and purity. Investigate this claim more fully, and then ask questions such as, "Why do Manitobans drink so much bottled water?"

**SPECIFIC LEARNING OUTCOME**

**C11-4-19:** Describe the process of treating a water supply, identifying the allowable concentrations of metallic and organic species in water suitable for consumption.

(continued)

---

**SUGGESTIONS FOR ASSESSMENT**

---

**Rubrics/Checklists**

See Appendix 10 for a variety of rubrics and checklists that can be used for self-assessment, peer assessment, and teacher assessment.

**Research Reports**

Have students work individually or in small groups to research and report on the treatment of their local water supply. The information collected could be presented as

- written reports
- oral presentations
- bulletin board displays
- multimedia presentations

**Visual Displays**

Students could present the material they have collected using

- posters
- pamphlets
- bulletin boards
- models

Each of these presentation styles could be assessed using an appropriate rubric created with students prior to the assignment. Samples of presentation rubrics are provided in Appendix 10 of this document.

**Journal Writing**

Provide students with an opportunity to make personal comments about the state of our water supply, its abuse, water treatment concerns, and so on.

**Topic-Review Activity**

For an activity to review Topic 4, see Appendix 4.12: Solutions: Scavenger Hunt. Teachers could create their own set of questions to relate more specifically to their emphases, presentations, findings, and so on.

**SKILLS AND ATTITUDES OUTCOMES**

**C11-0-S9:** Draw a conclusion based on the analysis and interpretation of data.

Include: cause-and-effect relationships, alternative explanations, supporting or rejecting a hypothesis or prediction

**C11-0-D1:** Identify and explore a current STSE issue.

*Examples: clarify what the issue is, identify different viewpoints and/or stakeholders, research existing data/information...*

**C11-0-D2:** Evaluate implications of possible alternatives or positions related to an STSE issue.

*Examples: positive and negative consequences of a decision, strengths and weaknesses of a position...*

**C11-0-D3:** Recognize that decisions reflect values and consider their own values and those of others when making a decision.

*Examples: being in balance with nature, generating wealth, respecting personal freedom...*

**C11-0-A1:** Demonstrate confidence in their ability to carry out investigations in chemistry and to address STSE-related issues.

---

**LEARNING RESOURCES LINKS**

---



*Chemistry: The Central Science (Brown, et al. 722)*

*Chemistry: The Molecular Nature of Matter and Change (Silberberg 520)*

*Glencoe Chemistry: Matter and Change (Dingrando, et al. 185, 864)*

*McGraw-Hill Ryerson Chemistry, Combined Atlantic Edition (Mustoe, et al. 804)*

*McGraw-Hill Ryerson Chemistry 11, Ontario Edition (Mustoe, et al. 357)*

*Nelson Chemistry 11, Ontario Edition (Jenkins, et al. 291)*

*Nelson Chemistry 12: College Preparation, Ontario Edition (Davies, et al. 266)*





# TOPIC 5: ORGANIC CHEMISTRY

---

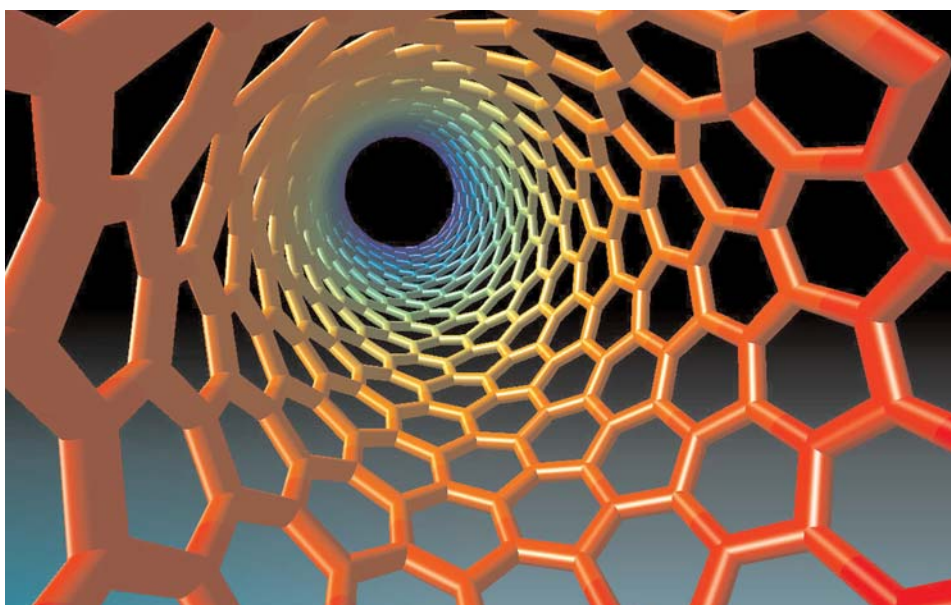



## Topic 5: Organic Chemistry

- C11-5-01** Compare and contrast inorganic and organic chemistry.  
Include: the contributions of Friedrich Wöhler to the overturn of vitalism
- C11-5-02** Identify the origins and major sources of hydrocarbons and other organic compounds.  
Include: natural and synthetic sources
- C11-5-03** Describe the structural characteristics of carbon.  
Include: bonding characteristics of the carbon atom in hydrocarbons (single, double, triple bonds)
- C11-5-04** Compare and contrast the molecular structures of alkanes, alkenes, and alkynes.  
Include: trends in melting points and boiling points of alkanes only
- C11-5-05** Name, draw, and construct structural models of the first 10 alkanes.  
Include: IUPAC nomenclature, structural formulas, condensed structural formulas, molecular formulas, general formula  $C_nH_{(2n+2)}$
- C11-5-06** Name, draw, and construct structural models of branched alkanes.  
Include: six-carbon parent chain, methyl and ethyl substituent groups, IUPAC nomenclature
- C11-5-07** Name, draw, and construct structural models of isomers for alkanes up to six-carbon atoms.  
Include: condensed structural formulas
- C11-5-08** Outline the transformation of alkanes to alkenes and vice versa.  
Include: dehydrogenation/hydrogenation, molecular models
- C11-5-09** Name, draw, and construct molecular models of alkenes and branched alkenes.  
Include: six-carbon parent chain, methyl and ethyl substituent groups, IUPAC nomenclature, structural formulas, condensed structural formulas, molecular formulas, general formula  $C_nH_{2n}$
- C11-5-10** Differentiate between saturated and unsaturated hydrocarbons.
- C11-5-11** Outline the transformation of alkenes to alkynes and vice versa.  
Include: dehydrogenation/hydrogenation, molecular models
- C11-5-12** Name, draw, and construct structural models of alkynes and branched alkynes.  
Include: six-carbon parent chain, methyl and ethyl substituent groups, IUPAC nomenclature, structural formulas, condensed structural formulas, molecular formulas, general formula  $C_nH_{2n-2}$
- C11-5-13** Compare and contrast the structure of aromatic and aliphatic hydrocarbons.  
Include: molecular models, condensed structural formulas
- C11-5-14** Describe uses of aromatic hydrocarbons.  
*Examples: polychlorinated biphenyls, caffeine, steroids, organic solvents (toluene, xylene)...*
- C11-5-15** Write condensed structural formulas for and name common alcohols.  
Include: maximum of six-carbon parent chain, IUPAC nomenclature
- C11-5-16** Describe uses of methyl, ethyl, and isopropyl alcohols.
- C11-5-17** Write condensed structural formulas for and name organic acids.  
Include: maximum of six-carbon parent chain, IUPAC nomenclature
- C11-5-18** Describe uses or functions of common organic acids.  
*Examples: acetic, ascorbic, citric, formic, acetylsalicylic (ASA), lactic...*
- C11-5-19** Perform a lab involving the formation of esters, and examine the process of esterification.
- C11-5-20** Write condensed structural formulas for and name esters.  
Include: up to 6-C alcohols and 6-C organic acids, IUPAC nomenclature
- C11-5-21** Describe uses of common esters.  
*Examples: pheromones, artificial flavourings...*
- C11-5-22** Describe the process of polymerization and identify important natural and synthetic polymers.  
*Examples: polyethylene, polypropylene, polystyrene, polytetrafluoroethylene (Teflon®)...*
- C11-5-23** Describe how the products of organic chemistry have influenced quality of life.  
*Examples: synthetic rubber, nylon, medicines, polytetrafluoroethylene (Teflon®)...*
- C11-5-24** Use the decision-making process to investigate an issue related to organic chemistry.  
*Examples: gasohol production, alternative energy sources, recycling of plastics...*

**Suggested Time: 17.0 hours**

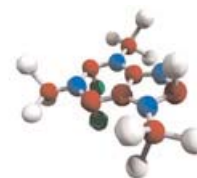

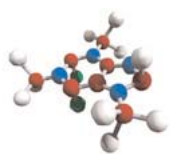
**SPECIFIC LEARNING OUTCOME****C11-5-01:** Compare and contrast inorganic and organic chemistry.

Include: the contributions of Friedrich Wöhler to the overturn of vitalism

**(1.0 hour)**

SLO: C11-5-01

**SUGGESTIONS FOR INSTRUCTION****Entry-Level Knowledge**

Students should know many organic compounds but they may not know that these substances fall under the general category of *organic*. Students may say that *organic* means grown without the aid of fertilizers or chemical enhancements.

**TEACHER NOTES**

During the 1950s, plant splicing occurred to improve resistance to diseases, such as rust. M.S. Joseph Murachy, from Shoal Lake, Manitoba, is credited with the development of a wheat strain that was resistant to rust 15B. He then crossed this variety of wheat with Exchange and Redman varieties to create a strongly resistant form of wheat that became famous. The new strain was commonly called Selkirk wheat.



The following website can be used to collect information concerning the history of the introduction of resistant strains of cereal grains into the Prairie region.

Agriculture and Agri-Food Canada. Cereal Research Centre, Winnipeg:

<[http://res2.agr.ca/winnipeg/v1\\_e.htm](http://res2.agr.ca/winnipeg/v1_e.htm)>

**Activating Activity**

Provide students with a definition of an organic compound and then have them list as many compounds as they can. Ask students to write, in their journals, how their life would change if suddenly all the organic compounds they presently use ceased to exist. Students could sketch a picture of a world without organic materials.

**General Learning Outcome Connections**

- GLO A2:** Recognize that scientific knowledge is based on evidence, models, and explanations, and evolves as new evidence appears and new conceptualizations develop.
- GLO A4:** Identify and appreciate contributions made by women and men from many societies and cultural backgrounds that have increased our understanding of the world and brought about technological innovations.
- GLO B1:** Describe scientific and technological developments—past and present—and appreciate their impact on individuals, societies, and the environment, both locally and globally.
- GLO B2:** Recognize that scientific and technological endeavours have been and continue to be influenced by human needs and the societal context of the time.

**SKILLS AND ATTITUDES OUTCOMES**

**C11-0-U1:** Use appropriate strategies and skills to develop an understanding of chemical concepts.

Examples: analogies, concept frames, concept maps, manipulatives, particulate representations, role-plays, simulations, sort-and-predict frames, word cycles...

**C11-0-R1:** Synthesize information obtained from a variety of sources.

Include: print and electronic sources, specialists, other resource people

**Laboratory Activity/Demonstration**

Appendix 3.8: Indications of Chemical Reactions outlines a demonstration on the typical reaction of concentrated sulphuric acid with sugar to produce solid carbon and a number of other products that are toxic. This demonstration should be done in a fume hood, with all the necessary safety precautions noted in Appendix 3.8. The Material Safety Data Sheet for concentrated sulphuric acid should be available before the lab activity/demonstration occurs.

**TEACHER NOTES**

By 1800, chemistry had firmly become established as a science, and for the next decade scientists became keenly interested in studying the composition of substances and the manner in which they could be changed. As a result of investigations, scientists began to distinguish two types of compounds. Those derived from plant or animal sources became known as *organic compounds* and those obtained from mineral constituents of the Earth were called *inorganic compounds*.

Chemists were aware of a very large number of organic compounds (such as dyes, soaps, vinegars, sugars, perfumes, gums, and rubber, to mention a few) but were unable to explain how so many compounds could be made from only a few elements. Swedish chemist Jöns Jakob Berzelius (1779–1848) had just explained inorganic compounds as being formed by oppositely charged atoms. However, this did not explain organic compounds such as  $C_2H_6$ ,  $C_2H_4$ ,  $C_3H_8$ ,  $C_4H_{10}$ , and so on. It was common knowledge that  $Cl_2$  could be substituted for H in  $C_2H_6$  to produce  $C_2Cl_6$ . This meant, however, that a negative Cl could be substituted for a positive H. This was not consistent with Berzelius's idea of oppositely charged atoms attracting.

Up to this point, no organic compound had been synthesized from inorganic materials and, as a result, many scientists believed that organic compounds were formed only under the influence of a *vital force*. It was Friedrich Wöhler (1800–1882) who, in 1828, made a remarkable discovery at the University of Göttingham in Germany. He attempted to prepare ammonium cyanate by means of a double decomposition reaction in a solution of ammonium chloride and silver cyanate. Both of these compounds were considered to be *inorganic*. Instead of producing ammonium cyanate, however, he obtained crystals of urea, an organic compound.

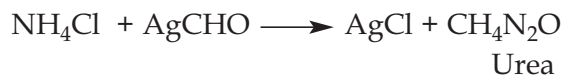

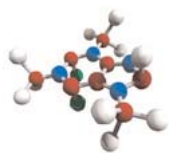
**SPECIFIC LEARNING OUTCOME****C11-5-01:** Compare and contrast inorganic and organic chemistry.

Include: the contributions of Friedrich Wöhler to the overturn of vitalism

*(continued)*

---

Within a few years of this event, when acetic acid and several other organic compounds had been prepared from inorganic materials, the validity of the *vital force* was questioned. As time passed, more and more organic compounds were synthesized from inorganic materials. It became obvious that it was not necessary for all organic compounds to be associated with living organisms. In the mid-1800s, it became apparent that the one factor common to all organic compounds was the element *carbon*. Chemists now simply say that organic compounds are compounds containing carbon.

**SUGGESTIONS FOR ASSESSMENT**

---

**Rubrics/Checklists**

See Appendix 10 for a variety of rubrics and checklists that can be used for self-assessment, peer assessment, and teacher assessment.

**Journal Writing**

Students should comment about the lab activity/demonstration.

**Laboratory Reports**

The lab activities suggested for this learning outcome could be assessed as formal lab reports using the Laboratory Report Outline or the Laboratory Report Format (see *SYSTH* 11.38, 14.12) or by using questions and answers from the data collected from the activities.

**Paper-and-Pencil Task**

Students could outline Friedrich Wöhler's contributions to the understanding of organic chemistry.

### SKILLS AND ATTITUDES OUTCOMES

**C11-0-U1:** Use appropriate strategies and skills to develop an understanding of chemical concepts.

*Examples: analogies, concept frames, concept maps, manipulatives, particulate representations, role-plays, simulations, sort-and-predict frames, word cycles...*

**C11-0-R1:** Synthesize information obtained from a variety of sources.

Include: print and electronic sources, specialists, other resource people

---

### LEARNING RESOURCES LINKS

---



*Chemistry* (Chang 979)

*Chemistry* (Zumdahl and Zumdahl 1043)

*Chemistry: The Central Science* (Brown, et al. 983)

*Chemistry: The Molecular Nature of Matter and Change* (Silberberg 607)

*Glencoe Chemistry: Matter and Change* (Dingrando, et al. 698)

*Introductory Chemistry: A Foundation* (Zumdahl 575)

*McGraw-Hill Ryerson Chemistry, Combined Atlantic Edition* (Mustoe, et al. 321)

*McGraw-Hill Ryerson Chemistry 11, Ontario Edition* (Mustoe, et al. 534)

*Nelson Chemistry 11, Ontario Edition* (Jenkins, et al. 506)

*Nelson Chemistry 12, Ontario Edition* (van Kessel, et al. 6)

*Prentice Hall Chemistry: Connections to Our Changing World* (LeMay, et al. 810)

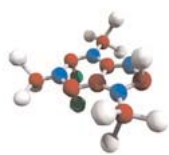

**SPECIFIC LEARNING OUTCOME**

**C11-5-02:** Identify the origins and major sources of hydrocarbons and other organic compounds.

Include: natural and synthetic sources

(0.5 hour)

SLO: C11-5-02

**SUGGESTIONS FOR INSTRUCTION****Entry-Level Knowledge**

The formation of fossil fuels was discussed in detail in Grade 7 Science:

- 7-4-06: Identify geological resources that are used by humans as sources of energy, and describe their method of formation.

Include: fossil fuels, geothermal energy

**Assessing Prior Knowledge**

Check for student understanding of prior knowledge and review as necessary. Prior knowledge can be reviewed and/or assessed by using any of the KWL strategies (e.g., Concept Map, Knowledge Chart, Think-Pair-Share—see *SYSTH*, Chapter 9).

**TEACHER NOTES**

Many texts provide information about the origin of and major sources of hydrocarbons. Through the review process, remind students that naturally occurring hydrocarbon compounds have resulted from the decay of prehistoric animals and vegetation. The hydrocarbon fuels resulting from the compaction of organic material are generally called *fossil fuels* or *petroleum* products. The word *petroleum* is derived from the Latin roots *petra*, meaning rock, and *oleum*, for oil.

Introduce students to the process of refining crude oil. This is a large topic that could easily become unmanageable. Students should know the general idea behind the process of fractional distillation and how heavy crude oil is “cracked” into lighter, smaller-chain carbonaceous fuels to be used as petroleum products.

Petroleum products are also produced synthetically. Synthetic hydrocarbons are constructed by starting with a petrochemical compound and adding to it, thus creating longer-chain hydrocarbons.

**General Learning Outcome Connections**

**GLO A2:** Recognize that scientific knowledge is based on evidence, models, and explanations, and evolves as new evidence appears and new conceptualizations develop.

**GLO A4:** Identify and appreciate contributions made by women and men from many societies and cultural backgrounds that have increased our understanding of the world and brought about technological innovations.

**GLO B1:** Describe scientific and technological developments—past and present—and appreciate their impact on individuals, societies, and the environment, both locally and globally.

**GLO B2:** Recognize that scientific and technological endeavours have been and continue to be influenced by human needs and the societal context of the time.

**SKILLS AND ATTITUDES OUTCOMES**

**C11-0-U1:** Use appropriate strategies and skills to develop an understanding of chemical concepts.

*Examples: analogies, concept frames, concept maps, manipulatives, particulate representations, role-plays, simulations, sort-and-predict frames, word cycles...*

**C11-0-R1:** Synthesize information obtained from a variety of sources.

Include: print and electronic sources, specialists, other resource people

Many synthetic products are more stable at higher temperatures and are very insoluble in most liquids (especially water), making them excellent lubricants.

There are many patented methods of producing petroleum-like products. A few of these methods are provided as examples below:

- Syntroleum<sup>®</sup> is a patented process for converting natural gas into synthetic hydrocarbon liquids that have both fuel and lubricant properties.
- There is a Russian patent on a process that determines the production of synthetic substances such as methane. The process uses a static field and ultraviolet light to catalyze the following reactions:



The acetylene reacts with hydrogen to produce a number of saturated and unsaturated hydrocarbons that transform to a petroleum-like mixture after condensing.

- The Alberta tar sand material is called *bitumen*. In the extraction process, the larger-chain, complex bitumen is cracked into synthetic crude oil.

The following website provides further information on the process.

Alberta. Oil Sands Discovery Centre. The Oil Sands Story: Upgrading:

<[http://www.oilsandsdiscovery.com/oil\\_sands\\_story/upgrade.html](http://www.oilsandsdiscovery.com/oil_sands_story/upgrade.html)>

**Research Activities**

1. Have students research the world producers of crude oil, including the daily capacity in barrels of oil produced. Also have them research crude oil production in Canada, as well as the projected consumption of oil for North America and the rest of the world.
2. Have students research the advertised characteristics of synthetic oils, compared to natural crude oil products.

**STSE Decision-Making Issue**

A detailed history of the development of synthetic products from the perspective of a major producer is available on the following website.

SynLube<sup>™</sup>: <<http://www.synlube.com/synthetic.htm>>



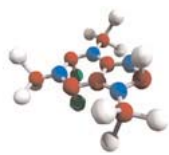

**SPECIFIC LEARNING OUTCOME**

**C11-5-02:** Identify the origins and major sources of hydrocarbons and other organic compounds.

Include: natural and synthetic sources

*(continued)*



**SUGGESTIONS FOR ASSESSMENT**

---

**Rubrics/Checklists**

See Appendix 10 for a variety of rubrics and checklists that can be used for self-assessment, peer assessment, and teacher assessment.

**Research Reports**

Have students conduct their research and report their findings either individually or in small groups. The information collected could be presented as

- written reports
- oral presentations
- bulletin board displays
- multimedia presentations

**Visual Displays**

Students could present the material they have collected using

- posters
- bulletin boards
- models

Each of these presentation styles could be assessed using an appropriate rubric created with students prior to the assignment. Samples of presentation rubrics are provided in Appendix 10 of this document.

### SKILLS AND ATTITUDES OUTCOMES

**C11-0-U1:** Use appropriate strategies and skills to develop an understanding of chemical concepts.

*Examples: analogies, concept frames, concept maps, manipulatives, particulate representations, role-plays, simulations, sort-and-predict frames, word cycles...*

**C11-0-R1:** Synthesize information obtained from a variety of sources.

Include: print and electronic sources, specialists, other resource people

---

### LEARNING RESOURCES LINKS

---



*Chemistry* (Chang 1003)

*Chemistry* (Zumdahl and Zumdahl 267)

*Chemistry: The Central Science* (Brown, et al. 983)

*Chemistry: Concepts and Applications* (Phillips, Strozak, and Wistrom 145, 638)

*Glencoe Chemistry: Matter and Change* (Dingrando, et al. 725)

*Introductory Chemistry: A Foundation* (Zumdahl 588)

*McGraw-Hill Ryerson Chemistry 11, Ontario Edition* (Mustoe, et al. 332, 579, 619)

*Nelson Chemistry 11, Ontario Edition* (Jenkins, et al. 507)

*Nelson Chemistry 12, Ontario Edition* (van Kessel, et al. 22)

*Nelson Chemistry 12: College Preparation, Ontario Edition* (Davies, et al. 193)

*Prentice Hall Chemistry: Connections to Our Changing World* (LeMay, et al. 823)

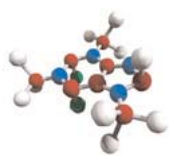
**SPECIFIC LEARNING OUTCOMES**

**C11-5-03:** Describe the structural characteristics of carbon.

Include: bonding characteristics of the carbon atom in hydrocarbons (single, double, triple bonds)

**C11-5-04:** Compare and contrast the molecular structures of alkanes, alkenes, and alkynes.

Include: trends in melting points and boiling points of alkanes only

(1.0 hour)

SLO: C11-5-03  
SLO: C11-5-04

**SUGGESTIONS FOR INSTRUCTION****Entry-Level Knowledge**

Students in Grade 9 Science (learning outcomes S1-2-03 to S1-2-08) were introduced to elements on the periodic table. They were also responsible for drawing Bohr models of atoms up to atomic number 18, including the element carbon (S1-2-03).

In Grade 10 Science, students were also introduced to periodicity, the combining capacity of elements, and the characteristics of common elements, including carbon (S2-2-01). They were also introduced to Lewis Dot Diagrams to illustrate the combining capacity of an atom to form both ionic and covalent bonds (S2-2-02). Synthesis and decomposition of simple organic compounds such as methane and propane would most likely have been addressed in Grade 10 Science (S2-2-07).

**Assessing Prior Knowledge**

Check for student understanding of prior knowledge and review as necessary. Prior knowledge can be reviewed and/or assessed by using any of the KWL strategies (e.g., Concept Map, Knowledge Chart, Think-Pair-Share—see *SYSTH*, Chapter 9).

**TEACHER NOTES**

In reviewing prior knowledge, remind students that because of its position on the periodic table, carbon has four valence electrons that are available for chemical bonding. Since carbon is a non-metal, its preferred form of bonding is covalent with the sharing of four electrons.

**General Learning Outcome Connections**

**GLO D1:** Understand essential life structures and processes pertaining to a wide variety of organisms, including humans.

**GLO D3:** Understand the properties and structures of matter, as well as various common manifestations and applications of the actions and interactions of matter.

**GLO D5:** Understand the composition of the Earth's atmosphere, hydrosphere, and lithosphere, as well as the processes involved within and among them.

**SKILLS AND ATTITUDES OUTCOMES**

**C11-0-U1:** Use appropriate strategies and skills to develop an understanding of chemical concepts.

*Examples: analogies, concept frames, concept maps, manipulatives, particulate representations, role-plays, simulations, sort-and-predict frames, word cycles...*

**C11-0-R1:** Synthesize information obtained from a variety of sources.

Include: print and electronic sources, specialists, other resource people

These four valence electrons easily bond to four hydrogen atoms, forming the simplest organic molecule methane.

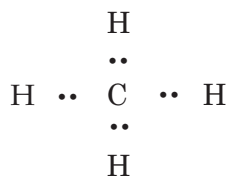

Note that there are eight electrons around the carbon atom for a complete octet. The double dots that represent two electrons or an electron pair will now be represented by a single covalent bond line.

**Laboratory Demonstration: Preparation of Methane**

This lab is best done as a demonstration either by the teacher or by selected students under the supervision of a teacher.

Place about 1 g of anhydrous sodium acetate and 2 g of soda lime in a large test tube and mix thoroughly. Heat the mixture. The gas is collected by the displacement of water. If two test tubes of methane are collected, the physical properties of the gas can be observed, as well as the flammability of the gas.

**TEACHER NOTES**

The reaction of sulphuric acid at 170°C with an alcohol of a single-bond hydrocarbon such as C<sub>2</sub>H<sub>5</sub>OH will release water and become C<sub>2</sub>H<sub>4</sub> or H<sub>2</sub>C = CH<sub>2</sub>. The acid acts as a catalyst according to the following reaction:

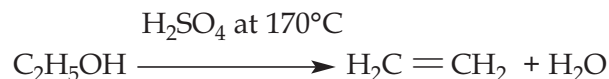

The structural formula:  $\text{H} - \text{C} = \text{C} - \text{H}$   
 $\begin{array}{cc} | & | \\ \text{H} & \text{H} \end{array}$

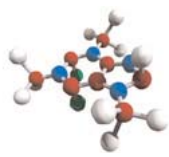
**SPECIFIC LEARNING OUTCOMES**

**C11-5-03:** Describe the structural characteristics of carbon.

Include: bonding characteristics of the carbon atom in hydrocarbons (single, double, triple bonds)

**C11-5-04:** Compare and contrast the molecular structures of alkanes, alkenes, and alkynes.

Include: trends in melting points and boiling points of alkanes only

(continued)

Students may be familiar with the existence of, and arrangement of, a triple covalent bond if they discussed nitrogen gas in Grade 10 Science (learning outcome S2-2-04). To maintain the stable octet, three pairs of electrons are shared between the nitrogen atoms:

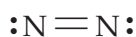

This structure can then be related to a similar bond found in an alkyne. The first member of this series is ethyne or what is commonly called acetylene:

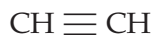

Students should note that there are still four bonds connected to each carbon atom and the electronic octet is still intact.

**Laboratory Demonstration: Preparation of Acetylene**

This lab procedure is best done by the teacher or by selected students under the close supervision of the teacher.

Fill two large test tubes with water and invert them in a pneumatic trough also filled with water. Drop a lump of calcium carbide into the water trough and quickly cover it with one of the test tubes filled with water. The gas is collected by the displacement of water. Several test tubes of acetylene can be collected by this method. Once the tubes are filled with gas they can be stoppered and removed from the trough for testing. Test the gas for flammability using a burning splint. The reaction for the preparation of acetylene is as follows:

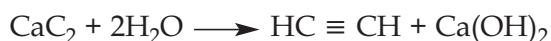

A more detailed discussion of the three series of alkanes, alkenes, and alkynes will occur in relation to learning outcomes C11-5-05, C11-5-09, and C11-5-12.

**SKILLS AND ATTITUDES OUTCOMES**

**C11-0-U1:** Use appropriate strategies and skills to develop an understanding of chemical concepts.

*Examples: analogies, concept frames, concept maps, manipulatives, particulate representations, role-plays, simulations, sort-and-predict frames, word cycles...*

**C11-0-R1:** Synthesize information obtained from a variety of sources.

Include: print and electronic sources, specialists, other resource people

Textbooks will usually have some of the physical properties of at least the first two series of hydrocarbon compounds, the alkanes and alkenes. Some data are provided in the following table.

Physical Properties of Some Normal Saturated Hydrocarbons				
Name	Formula	MP °C	BP °C	State
Methane	CH <sub>4</sub>	-182.6	-161.4	gas
Ethane	C <sub>2</sub> H <sub>6</sub>	-172.0	-88.3	gas
Propane	C <sub>3</sub> H <sub>8</sub>	-187.1	-44.5	gas
<i>n</i> -Butane	C <sub>4</sub> H <sub>10</sub>	-135.0	-0.5	gas
<i>n</i> -Pentane	C <sub>5</sub> H <sub>12</sub>	-129.7	36.2	liquid
<i>n</i> -Hexane	C <sub>6</sub> H <sub>14</sub>	-94.0	69	liquid
<i>n</i> -Heptane	C <sub>7</sub> H <sub>16</sub>	-90.5	98.4	liquid
<i>n</i> -Octadecane	C <sub>18</sub> H <sub>38</sub>	28	308	solid

**Reference:** Linstromberg, Walter W., and Henry E. Baumgarten. *Organic Chemistry: A Brief Course*. Lexington, MA: D.C. Heath and Company, 1978. 43.

**Properties of Normal Paraffin Hydrocarbons**

Have students carefully plot a data chart (by hand, initially) that illustrates the relationships among melting point (MP), boiling point (BP), and the number of carbons in the parent chain (up to 15-C at least). A sample plot is provided for teacher reference.

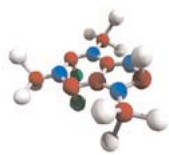

**SPECIFIC LEARNING OUTCOMES**
**C11-5-03:** Describe the structural characteristics of carbon.

Include: bonding characteristics of the carbon atom in hydrocarbons (single, double, triple bonds)

**C11-5-04:** Compare and contrast the molecular structures of alkanes, alkenes, and alkynes.

Include: trends in melting points and boiling points of alkanes only

(continued)

Properties of Paraffin Hydrocarbons		
Number of Carbons in Chain	Melting Point (°C)	Boiling Point (°C)
1	-180	-160
2	-190	-90
3	-175	-40
4	-140	0
5	-140	+40
6	-90	+80
7	-95	+100
8	-50	+140
9	-45	+150
10	-20	+180
11	-20	+195
12	0	+220
13	-5	+250
14	+5	+270
15	+15	+290

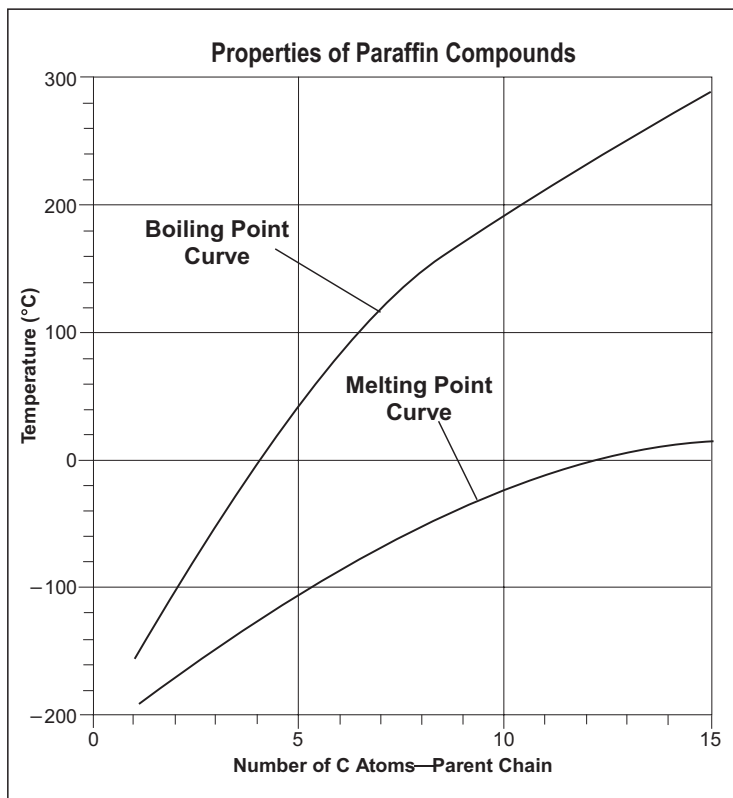

Students should intuit that the MP and BP are proportional to the molar mass or length of the hydrocarbon chain. While students are not expected to memorize the data, they should remember the general trends. For instance, there is a dramatic increase in the value of the physical properties for carbon chains from 1-C to 8-C.

**SKILLS AND ATTITUDES OUTCOMES**

**C11-0-U1:** Use appropriate strategies and skills to develop an understanding of chemical concepts.

*Examples: analogies, concept frames, concept maps, manipulatives, particulate representations, role-plays, simulations, sort-and-predict frames, word cycles...*

**C11-0-R1:** Synthesize information obtained from a variety of sources.

Include: print and electronic sources, specialists, other resource people

**SUGGESTIONS FOR ASSESSMENT****Rubrics/Checklists**

See Appendix 10 for a variety of rubrics and checklists that can be used for self-assessment, peer assessment, and teacher assessment.

**Paper-and-Pencil Tasks**

Students should be able to compare the difference in structure between the three series of hydrocarbon families. They should also be able to relate the chain length of the alkanes to the MP and BP of the members in that family.

**LEARNING RESOURCES LINKS**

*Chemistry* (Chang 980)

*Chemistry* (Zumdahl and Zumdahl 1044)

*Chemistry: The Central Science* (Brown, et al. 984)

*Chemistry: Concepts and Applications* (Phillips, Strozak, and Wistrom 176)

*Chemistry: The Molecular Nature of Matter and Change* (Silberberg 608)

*Glencoe Chemistry: Matter and Change* (Dingrando, et al. 698)

*Introductory Chemistry: A Foundation* (Zumdahl 576)

*McGraw-Hill Ryerson Chemistry, Combined Atlantic Edition* (Mustoe, et al. 342)

*McGraw-Hill Ryerson Chemistry 11, Ontario Edition* (Mustoe, et al. 538)

*Nelson Chemistry 11, Ontario Edition* (Jenkins, et al. 502)

*Nelson Chemistry 12, Ontario Edition* (van Kessel, et al. 11)

*Nelson Chemistry 12, College Preparation, Ontario Edition* (Davies, et al. 181)

*Prentice Hall Chemistry: Connections to Our Changing World* (LeMay, et al. 805)

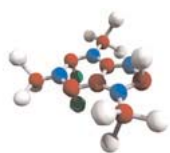
**SPECIFIC LEARNING OUTCOMES**

**C11-5-05:** Name, draw, and construct structural models of the first 10 alkanes.

Include: IUPAC nomenclature, structural formulas, condensed structural formulas, molecular formulas, general formula

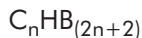

**C11-5-06:** Name, draw, and construct structural models of branched alkanes.

Include: six-carbon parent chain, methyl and ethyl substituent groups, IUPAC nomenclature

(1.5 hours)

SLO: C11-5-05  
SLO: C11-5-06

**SUGGESTIONS FOR INSTRUCTION****Entry-Level Knowledge**

Students are not expected to have any prior knowledge of learning outcomes C11-5-05 and C11-5-06, other than knowing that the carbon atom has four valence electrons and needs to share four other electrons to achieve a stable octet.

**TEACHER NOTES**

If possible, have students work with atomic models that will allow them to see the structural arrangement of atoms as they build each successive structure in the alkane series. Using other materials, such as marshmallows and toothpicks, to create the alkane series may give students the wrong impression of the actual three-dimensional structure. If not enough model kits are available for students to use, then at least one set should be available for the teacher to illustrate the correct structures.

**Activity**

The learning activities in this document are written as suggestions only. Teachers are expected to use whatever materials are available to present a concept effectively.

Give student pairs a number of

- black carbon atom representations with four holes in them to bond to other carbon atoms
- white hydrogen atoms with one hole in them to connect with the carbon atoms

**General Learning Outcome Connections**

**GLO D3:** Understand the properties and structures of matter, as well as various common manifestations and applications of the actions and interactions of matter.

**SKILLS AND ATTITUDES OUTCOMES**

**C11-0-U1:** Use appropriate strategies and skills to develop an understanding of chemical concepts.

*Examples: analogies, concept frames, concept maps, manipulatives, particulate representations, role-plays, simulations, sort-and-predict frames, word cycles...*

**C11-0-R1:** Synthesize information obtained from a variety of sources.

Include: print and electronic sources, specialists, other resource people

After showing students how to connect the atoms carefully, allow them to construct molecules of the alkane series. Many students will know the Latin prefixes for the number of carbon atoms: *meth, eth, prop, but, pent, hex, hept, oct, non, and dec*. Ask students to use the general formula to determine the number of hydrogen atoms for a given number of carbon atoms.

**TEACHER NOTES**

Students should be able to draw at least the first 10 alkanes. In addition, they should be able to name the compounds, when given either the molecular formula or the structural formula.

Students should also know the general formula for the alkanes and the International Union of Pure and Applied Chemistry (IUPAC) nomenclature, which enables scientists to talk to each other about organic compounds using a common naming system. Teachers will remember that there are other methods of naming organic compounds (e.g., the common name, the derived name).



For information about current nomenclature rules and for additional information and examples about the naming of organic compounds, see the following websites:

The Catalyst: Chemistry Resource for the Secondary Education Teacher on the WWW: <<http://catalyst.8media.org/m13organ.html>>

This online resource is intended for teachers interested in a wide-ranging “clearinghouse” website related to organic chemistry topics.

Michigan State University. Nomenclature: Naming Organic Compounds: <<http://www.cem.msu.edu/~reusch/VirtualText4/nomen1.htm>>

This website provides a detailed, comprehensive treatment of why a systematic naming of organic compounds is necessary to chemists, and thoroughly treats all important groups of compounds and homologous series.

The IUPAC organic naming system enables scientists to name very complex branched molecules. This brief introduction to organic chemistry is not intended to overwhelm students with complex structures. These learning outcomes specify only that methyl and ethyl side chains be used with a maximum six-carbon parent chain:

- methylpropane
- dimethylpropane
- 2-methylbutane
- 2,2,3,4-tetramethylpentane

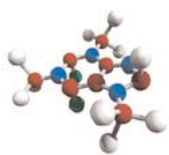
**SPECIFIC LEARNING OUTCOMES**

**C11-5-05:** Name, draw, and construct structural models of the first 10 alkanes.

Include: IUPAC nomenclature, structural formulas, condensed structural formulas, molecular formulas, general formula

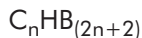

**C11-5-06:** Name, draw, and construct structural models of branched alkanes.

Include: six-carbon parent chain, methyl and ethyl substituent groups, IUPAC nomenclature

(continued)

**IUPAC Rules for Nomenclature**

The general IUPAC rules for nomenclature are:

1. Find and name the *longest continuous carbon chain*.
2. Identify and name groups attached to this chain.
3. Number the chain consecutively, starting at the end nearest a *substituent* group.
4. Designate the location of each substituent by an appropriate *number* and *name*.
5. An older rule required that the sum of the numbers be as small as possible; however, a relatively new rule requires that the lower first number be used, so 1,1,3- would be used rather than 1,2,2-, and 1,1,3,4- rather than 1,2,2,3-. (This would apply to functional groups and not to branched alkanes, as identifying a branch group with a 1 would make the parent chain longer.)
6. Assemble the name, listing groups in *alphabetical order*. The prefixes (e.g., *di*, *tri*, *tetra*, etc.) used to designate several groups of the same kind are not considered when alphabetizing (e.g., 3-ethyl-2,2-dimethylpentane).

**Reference:** Linstromberg, Walter W., and Henry E. Baumgarten. *Organic Chemistry: A Brief Course*. Lexington, MA: D.C. Heath and Company, 1978. 37-38.

**SUGGESTIONS FOR ASSESSMENT****Paper-and-Pencil Tasks**

Students should be able to write the correct formulas when given the name of a branched alkane with a parent chain up to six-carbon atoms. They should also be able to produce the name when given either the structural or molecular formula.

### SKILLS AND ATTITUDES OUTCOMES

**C11-0-U1:** Use appropriate strategies and skills to develop an understanding of chemical concepts.

*Examples: analogies, concept frames, concept maps, manipulatives, particulate representations, role-plays, simulations, sort-and-predict frames, word cycles...*

**C11-0-R1:** Synthesize information obtained from a variety of sources.

Include: print and electronic sources, specialists, other resource people

---

### LEARNING RESOURCES LINKS

---



*Chemistry* (Chang 982)

*Chemistry* (Zumdahl and Zumdahl 1044)

*Chemistry: The Central Science* (Brown, et al. 987)

*Chemistry: Concepts and Applications* (Phillips, Strozak, and Wistrom 623)

*Chemistry: The Molecular Nature of Matter and Change* (Silberberg 614)

*Glencoe Chemistry: Matter and Change* (Dingrando, et al. 699)

*Introductory Chemistry: A Foundation* (Zumdahl 577)

*McGraw-Hill Ryerson Chemistry, Combined Atlantic Edition* (Mustoe, et al. 333)

*McGraw-Hill Ryerson Chemistry 11, Ontario Edition* (Mustoe, et al. 547)

*Nelson Chemistry 11, Ontario Edition* (Jenkins, et al. 509)

*Nelson Chemistry 12, Ontario Edition* (van Kessel, et al. 12)

*Nelson Chemistry 12, College Preparation, Ontario Edition* (Davies, et al. 182)

*Prentice Hall Chemistry: Connections to Our Changing World* (LeMay, et al. 816)

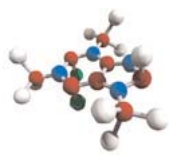
**SPECIFIC LEARNING OUTCOME**

**C11-5-07:** Name, draw, and construct structural models of isomers for alkanes up to six-carbon atoms.

Include: condensed structural formulas

(0.5 hour)

SLO: C11-5-07

**SUGGESTIONS FOR INSTRUCTION**
**Entry-Level Knowledge**

Students are not expected to have any entry-level knowledge other than their current knowledge of organic IUPAC nomenclature.

**TEACHER NOTES**

Students should build these molecular models using techniques similar to those used for the previous learning outcome (C11-5-06).

*Structural isomers* are compounds having the same molecular formula,  $C_5H_{12}$ , but a different structural formula.

*Example:*

*n*-pentane  $CH_3CH_2CH_2CH_2CH_3$

2-methylbutane  $CH_3CHCH_2CH_3$   
                                   |  
                                    $CH_3$

2,2-dimethylpropane  $CH_3CCH_3$   
                                   |  
                                    $CH_3$

**General Learning Outcome Connections**

- GLO B1:** Describe scientific and technological developments—past and present—and appreciate their impact on individuals, societies, and the environment, both locally and globally.
- GLO B2:** Recognize that scientific and technological endeavours have been and continue to be influenced by human needs and the societal context of the time.
- GLO D1:** Understand essential life structures and processes pertaining to a wide variety of organisms, including humans.
- GLO D3:** Understand the properties and structures of matter, as well as various common manifestations and applications of the actions and interactions of matter.
- GLO E1:** Describe and appreciate the similarity and diversity of forms, functions, and patterns within the natural and constructed world.

**SKILLS AND ATTITUDES OUTCOME**

**C11-0-U1:** Use appropriate strategies and skills to develop an understanding of chemical concepts.

*Examples: analogies, concept frames, concept maps, manipulatives, particulate representations, role-plays, simulations, sort-and-predict frames, word cycles...*

Structural isomers will have the same molar mass but differing physical and chemical properties. The number of isomers that are possible for a given molecular formula increases rapidly with the number of carbon atoms.

Number of Carbon Atoms	Number of Isomers
4	2
5	3
6	5
10	75
40	62,491,178,805,831

**Activity**

Have students try to draw all the possible structures for heptane,  $C_7H_{16}$ . That should keep them busy for a while!

While other kinds of isomerism (beyond structural) could be addressed, they are not discussed in Grade 11 Chemistry (they are reserved for advanced-level study).

**SUGGESTION FOR ASSESSMENT****Paper-and-Pencil Task**

Students should be able to use an example to illustrate and explain isomers.

**LEARNING RESOURCES LINKS**

*Chemistry* (Chang 981)

*Chemistry* (Zumdahl and Zumdahl 1045)

*Chemistry: The Central Science* (Brown, et al. 988)

*Chemistry: Concepts and Applications* (Phillips, Strozak, and Wistrom 628)

*Chemistry: The Molecular Nature of Matter and Change* (Silberberg 623)

*Glencoe Chemistry: Matter and Change* (Dingrando, et al. 717)

*Introductory Chemistry: A Foundation* (Zumdahl 579)

*McGraw-Hill Ryerson Chemistry, Combined Atlantic Edition* (Mustoe, et al. 326)

*McGraw-Hill Ryerson Chemistry 11, Ontario Edition* (Mustoe, et al. 539)

*Nelson Chemistry 11, Ontario Edition* (Jenkins, et al. 529)

*Nelson Chemistry 12, Ontario Edition* (van Kessel, et al. 13, 814)

*Prentice Hall Chemistry: Connections to Our Changing World* (LeMay, et al. 820)



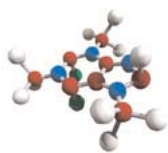

## SPECIFIC LEARNING OUTCOME

**C11-5-08:** Outline the transformation of alkanes to alkenes and vice versa.

Include: dehydrogenation/hydrogenation, molecular models

(0.5 hour)

SLO: C11-5-08

## SUGGESTIONS FOR INSTRUCTION

## Entry-Level Knowledge

The formation of fossil fuels was discussed in detail in Grade 7 Science:

- 7-4-06: Identify geological resources that are used by humans as sources of energy, and describe their method of formation.

Include: fossil fuels, geothermal energy.

Students may not have been taught much about the *cracking process*, but they may be aware of its purpose in the refining of petroleum products.

## Assessing Prior Knowledge

Check for student understanding of prior knowledge and review as necessary. Prior knowledge can be reviewed and/or assessed by using any of the KWL strategies (e.g., Concept Map, Knowledge Chart, Think-Pair-Share—see *SYSTH*, Chapter 9).

## TEACHER NOTES

The chemical processes involving organic compounds are not simple. This is true for the transformation of alkanes to alkenes and the reverse. However, this is a logical way to introduce the next homologous family of alkenes or olefins. Short-chain alkanes are found in crude oil before it is introduced to the cracking process, sometimes called *fractional distillation* or *pyrolysis*. The word *pyrolysis* is taken from the Greek word *pyr*, meaning fire, and *lysis*, a loosening. To chemists, it means a cleavage by heat. During the pyrolysis of crude oil, smaller-chain alkenes are produced.

At this point, teachers can show students how a multiple bond forms by the removal of hydrogen. Each C atom still maintains an octet.

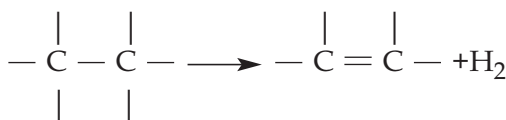

## General Learning Outcome Connections

**GLO D3:** Understand the properties and structures of matter, as well as various common manifestations and applications of the actions and interactions of matter.

**GLO D4:** Understand how stability, motion, forces, and energy transfers and transformations play a role in a wide range of natural and constructed contexts.

**GLO E3:** Recognize that characteristics of materials and systems can remain constant or change over time, and describe the conditions and processes involved.

**SKILLS AND ATTITUDES OUTCOMES**

**C11-0-U1:** Use appropriate strategies and skills to develop an understanding of chemical concepts.

Examples: analogies, concept frames, concept maps, manipulatives, particulate representations, role-plays, simulations, sort-and-predict frames, word cycles...

**C11-0-R1:** Synthesize information obtained from a variety of sources.

Include: print and electronic sources, specialists, other resource people

The pyrolysis of alkanes, when petroleum is concerned, is known as *cracking*. In the thermal cracking process, alkanes are simply passed through a high temperature reaction chamber. Large alkane chains are converted into smaller alkane molecules, alkenes, and some hydrogen. This process produces mainly ethylene. Because hydrogen is released or removed during the reaction, the process is also called *dehydrogenation*. Steam cracking is a process whereby the hydrocarbons are diluted with steam and instantly heated to 700°C to 900°C. This process produces ethylene, propylene, and a number of important *dienes*.

It is interesting to note that *n*-butane will dehydrogenate with high temperature and a catalyst to form a mixture of 1-butene and 2-butene.

Students should understand that the conversion of alkanes to alkenes requires a complex process that produces a number of different products.

In contrast, alkenes are converted to alkanes by a less complex reaction. Hydrogen can be added to an alkene in the presence of a nickel, platinum, or palladium catalyst. For obvious reasons, this process is called an *addition reaction* and is a common reaction in organic chemistry. Not surprisingly, this reaction is also called *catalytic hydrogenation*.

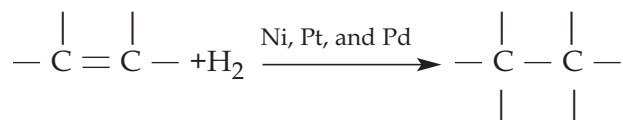
**SUGGESTIONS FOR ASSESSMENT**

Toward the end of any course, time becomes critical. Unfortunately, it is not uncommon for teachers to be rushed in addressing Topic 5: Organic Chemistry at the end of Grade 11 Chemistry. It is hoped that organic chemistry will occasionally be moved to another place in the course so that it could be treated with the same enthusiasm and detail as the other topics. With this in mind, if time is available, teachers could ask students to research the pyrolysis of crude oil and become involved with STSE issues. The assessment suggestions that follow reflect a detailed treatment of this topic.

**Rubrics/Checklists**

See Appendix 10 for a variety of rubrics and checklists that can be used for self-assessment, peer assessment, and teacher assessment.

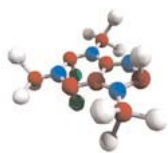
**SPECIFIC LEARNING OUTCOME****C11-5-08:** Outline the transformation of alkanes to alkenes and vice versa.

Include: dehydrogenation/hydrogenation, molecular models

*(continued)*

---

**Research Reports**

Have students conduct research and report their findings either individually or in small groups. The information collected can be presented as

- written reports
- oral presentations
- bulletin board displays
- multimedia presentations

**Visual Displays**

Students could present the material they have collected using

- posters
- pamphlets
- bulletin boards
- models

Each of these presentation styles could be assessed using an appropriate rubric created with students before the assignment was begun. Samples of presentation rubrics are provided in Appendix 10 of this document.

**STSE Decision-Making Issues**

Global concern over the depletion of renewable resources and the Kyoto Accord are always in the news. Another environmental concern is the transportation of petroleum products by any means, whether by rail, sea, or pipeline. Any of these issues would be exceptional discussion topics for environmental concerns.

**Journal Writing**

If students are exposed to the refining of crude oil and its subsequent transport around the world, they may wish to address related STSE issues in their journals.

**Paper-and-Pencil Tasks**

Students should be able provide a brief explanation of pyrolysis of crude oil in the formation of alkanes and in the transformation of alkanes to alkenes. They should also be able to write the hydrogenation reaction for the formation of alkanes from alkenes.

**SKILLS AND ATTITUDES OUTCOMES**

**C11-0-U1:** Use appropriate strategies and skills to develop an understanding of chemical concepts.

*Examples: analogies, concept frames, concept maps, manipulatives, particulate representations, role-plays, simulations, sort-and-predict frames, word cycles...*

**C11-0-R1:** Synthesize information obtained from a variety of sources.

Include: print and electronic sources, specialists, other resource people

---

**LEARNING RESOURCES LINKS**

---



*Chemistry* (Chang 989)

*Chemistry* (Zumdahl and Zumdahl 1055)

*Chemistry: The Central Science* (Brown, et al. 997)

*Introductory Chemistry: A Foundation* (Zumdahl 592)

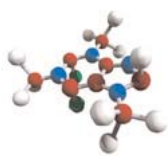
**SPECIFIC LEARNING OUTCOME**

**C11-5-09:** Name, draw, and construct molecular models of alkenes and branched alkenes.

Include: six-carbon parent chain, methyl and ethyl substituent groups, IUPAC nomenclature, structural formulas, condensed structural formulas, molecular formulas, general formula  $C_nH_{2n}$

(1.5 hours)

SLO: C11-5-09

**SUGGESTIONS FOR INSTRUCTION****Entry-Level Knowledge**

Students were introduced to alkenes in learning outcome C11-5-04 where a brief comparison was made to identify differences in structure and relative physical properties. Students have also drawn members of the homologous series of alkanes, as well as branched alkanes and isomers. They should now also understand the differences among molecular formulas, structural formulas, and condensed structural formulas.

**TEACHER NOTES**

Point out to students that the first member of the alkene series must be a two-carbon molecule, namely ethene. With a general formula of  $C_nH_{2n}$ , students should realize that the number of hydrogen atoms is double that of the number of carbon atoms. In addition, every member of this series will contain a double bond. Students should first draw structural formulas so they can more easily see the octet for each atom of carbon. The double bond also reduces the number of hydrogen atoms associated with the carbon atoms connected to the double bond. Students should use the atomic model kits again to create examples of molecules for this learning outcome. As students draw and construct ethene, propene, and so on, they will appreciate the structure of the compounds and the position of the hydrogen atoms around the molecule. When students get to butene, they should be shown the two possible isomers:

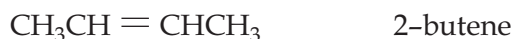

If students have understood the concept of numbering for branched alkane compounds, they will understand the necessity of naming the position of the double bond and correctly propose the names of the two isomers. Remind students that the numbering can begin from either end of the molecule, so the following structure is still 1-butene:

**General Learning Outcome Connections**

**GLO D3:** Understand the properties and structures of matter, as well as various common manifestations and applications of the actions and interactions of matter.

**SKILLS AND ATTITUDES OUTCOMES**

**C11-0-U1:** Use appropriate strategies and skills to develop an understanding of chemical concepts.

*Examples: analogies, concept frames, concept maps, manipulatives, particulate representations, role-plays, simulations, sort-and-predict frames, word cycles...*

**C11-0-R1:** Synthesize information obtained from a variety of sources.

Include: print and electronic sources, specialists, other resource people

Again, the learning outcome specifies using a maximum of six-carbon parent chains. The molecules will become complex enough once students begin to add branching side chains. The learning outcome also limits the side chains to methyl and ethyl groups. In Grade 11 Chemistry, there is no point in loading students down with complex side chains such as isopropyl. As students have already mastered branching side chains for the alkanes, the alkenes should be more straightforward. Inform students that the double bond is always numbered first, so as to be the smallest number.

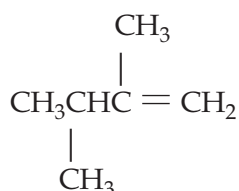

Remind students that the general formula must always work. In this case:  $\text{C}_6\text{H}_{12}$ .

The IUPAC standard naming is 2,3-dimethyl-1-butene.

The numbering of the parent chains is from right to left so that the multiple bond is on the first carbon rather than on the third carbon.

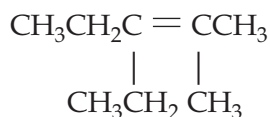

( $\text{C}_8\text{H}_{16}$ )

The IUPAC standard naming is 3-ethyl-2-methyl-2-pentene.

**Note:** All bonds are shown attached to the carbon atoms.

**SUGGESTIONS FOR ASSESSMENT****Paper-and-Pencil Tasks**

Students should be able to write the correct formula when given the name of the alkene and, conversely, they should be able to draw the correct condensed structural formula when given the name. Students should also be able to draw and name branched alkenes with a parent chain up to six-carbon atoms.

Keep in mind that it is easy to make up names for which the structure is impossible. Always write out the structure for a given name before giving examples or test questions to students.

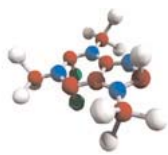

### SPECIFIC LEARNING OUTCOME

**C11-5-09:** Name, draw, and construct molecular models of alkenes and branched alkenes.

Include: six-carbon parent chain, methyl and ethyl substituent groups, IUPAC nomenclature, structural formulas, condensed structural formulas, molecular formulas, general formula  $C_nH_{2n}$

(continued)

---

### LEARNING RESOURCES LINKS

---



*Chemistry* (Chang 988)

*Chemistry* (Zumdahl and Zumdahl 1054)

*Chemistry: The Central Science* (Brown, et al. 994)

*Chemistry: Concepts and Applications* (Phillips, Strozak, and Wistrom 324)

*Chemistry: The Molecular Nature of Matter and Change* (Silberberg 618)

*Glencoe Chemistry: Matter and Change* (Dingrando, et al. 711)

*Introductory Chemistry: A Foundation* (Zumdahl 590)

*McGraw-Hill Ryerson Chemistry, Combined Atlantic Edition* (Mustoe, et al. 345)

*McGraw-Hill Ryerson Chemistry 11, Ontario Edition* (Mustoe, et al. 557)

*Nelson Chemistry 11, Ontario Edition* (Jenkins, et al. 543)

*Nelson Chemistry 12, Ontario Edition* (van Kessel, et al. 16)

*Nelson Chemistry 12, College Preparation, Ontario Edition* (Davies, et al. 184)

*Prentice Hall Chemistry: Connections to Our Changing World* (LeMay, et al. 825)

**SKILLS AND ATTITUDES OUTCOMES**

**C11-0-U1:** Use appropriate strategies and skills to develop an understanding of chemical concepts.

*Examples: analogies, concept frames, concept maps, manipulatives, particulate representations, role-plays, simulations, sort-and-predict frames, word cycles...*

**C11-0-R1:** Synthesize information obtained from a variety of sources.

Include: print and electronic sources, specialists, other resource people

---

**NOTES**



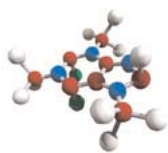

## SPECIFIC LEARNING OUTCOME

**C11-5-10:** Differentiate between saturated and unsaturated hydrocarbons.

(0.5 hour)

SLO: C11-5-10

## SUGGESTIONS FOR INSTRUCTION

**Entry-Level Knowledge**

Students may have heard the term *polyunsaturated* in reference to nutrition, diet, or health issues. Many students would, by now, also have heard of a family of partially hydrogenated fats known as *trans fats*. Ingestion of trans fats remains a nutritional issue of interest today.

**Assessing Prior Knowledge**

Check for student understanding of prior knowledge and review as necessary. Prior knowledge can be reviewed and/or assessed by using any of the KWL strategies (e.g., Concept Map, Knowledge Chart, Think-Pair-Share—see *SYSTH*, Chapter 9).

**TEACHER NOTES**

It is not necessary for students to understand all the complexities of *cis* vs. *trans* structures of alkenes. Suffice it to say that *trans fats* or *trans fatty acids* are formed when manufacturers hydrogenate unsaturated compounds with hydrogen to form saturated structures. Manufacturers have found that hydrogenating vegetable oils has many economic benefits. The process produces a solid product, extends its shelf life, increases its flavour stability, and reduces the risk of rancidity, to name a few benefits.

To use a non-scientific analogy, anything that is saturated cannot hold any more and so an alkane is unable to hold any more carbon atoms, whereas an alkene is able to add hydrogen to the double bond. Students should be able to draw the difference between an unsaturated alkene and a saturated alkane. In learning outcome C11-5-08, students were shown how alkanes could be transformed to alkenes and vice versa.

**General Learning Outcome Connections**

- GLO A4:** Identify and appreciate contributions made by women and men from many societies and cultural backgrounds that have increased our understanding of the world and brought about technological innovations.
- GLO B3:** Identify the factors that affect health, and explain the relationships among personal habits, lifestyle choices, and human health, both individual and social.
- GLO C8:** Evaluate, from a scientific perspective, information and ideas encountered during investigations and in daily life.
- GLO D3:** Understand the properties and structures of matter, as well as various common manifestations and applications of the actions and interactions of matter.

**SKILLS AND ATTITUDES OUTCOMES**

**C11-0-U1:** Use appropriate strategies and skills to develop an understanding of chemical concepts.

*Examples: analogies, concept frames, concept maps, manipulatives, particulate representations, role-plays, simulations, sort-and-predict frames, word cycles...*

**C11-0-R1:** Synthesize information obtained from a variety of sources.

Include: print and electronic sources, specialists, other resource people

**C11-0-D4:** Recommend an alternative or identify a position and provide justification.

**C11-0-D5:** Propose a course of action related to an STSE issue.



Much information is available on the topic of trans fats. If time is available and if students are interested in exploring the topic in more detail, they could find information on websites such as the following:

Macleans: <<http://www.macleans.ca>>

University of Guelph. Bruce J. Holub. Trans Watch:

<<http://www.uoguelph.ca/~bholub/trans.html>>

U.S. Food and Drug Administration. Revealing *Trans* Fats:

<[http://www.fda.gov/fdac/features/2003/503\\_fats.html](http://www.fda.gov/fdac/features/2003/503_fats.html)>

WebMD. Trans Fats: The Science and the Risks:

<<http://my.webmd.com/content/article/71/81217.htm>>

**SUGGESTIONS FOR ASSESSMENT****Research Reports**

Have students conduct research and report their findings either individually or in small groups. The information collected could be presented as

- written reports
- oral presentations
- bulletin board displays
- multimedia presentations

**Visual Displays**

Students could present the material they have collected using

- posters
- pamphlets
- bulletin boards
- models

Each of these presentation styles could be assessed using an appropriate rubric created with students prior to the assignment. Samples of presentation rubrics are provided in Appendix 10 of this document.

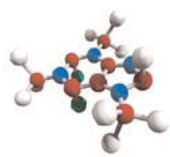

**SPECIFIC LEARNING OUTCOME**

**C11-5-10:** Differentiate between saturated and unsaturated hydrocarbons.

(continued)

---

**Journal Writing**

A few suggestions for discussion regarding obesity, trans fats, and the health of Canadians are provided below:

- How does the manufacturing industry use trans fats to sell products?
- How serious is the consumption of these fats today?
- Do we have a problem with obesity?
- Is there a solution to obesity?
- What effect will obesity have on future generations?

Ask students to reflect on or present opinions about these questions in their journals. If students are especially interested in this topic, give them an opportunity to use a decision-making process to decide what might be done to reduce the impact of obesity on future generations.

**Paper-and-Pencil Tasks**

Students should be able to show how the conversion of an alkane to an alkene produces an unsaturated compound.

Any assessment that results from the discussion of trans fats and related topics will depend on the teacher and the amount of time taken with the discussion.

### SKILLS AND ATTITUDES OUTCOMES

**C11-0-U1:** Use appropriate strategies and skills to develop an understanding of chemical concepts.

*Examples: analogies, concept frames, concept maps, manipulatives, particulate representations, role-plays, simulations, sort-and-predict frames, word cycles...*

**C11-0-R1:** Synthesize information obtained from a variety of sources.

*Include: print and electronic sources, specialists, other resource people*

**C11-0-D4:** Recommend an alternative or identify a position and provide justification.

**C11-0-D5:** Propose a course of action related to an STSE issue.

---

### LEARNING RESOURCES LINKS

---



*Chemistry* (Chang 980)

*Chemistry* (Zumdahl and Zumdahl 1044)

*Chemistry: Concepts and Applications* (Phillips, Strozak, and Wistrom 623)

*Chemistry: The Molecular Nature of Matter and Change* (Silberberg 613)

*Glencoe Chemistry: Matter and Change* (Dingrando, et al. 710)

*Introductory Chemistry: A Foundation* (Zumdahl 577)

*McGraw-Hill Ryerson Chemistry, Combined Atlantic Edition* (Mustoe, et al. 331)

*McGraw-Hill Ryerson Chemistry 11, Ontario Edition* (Mustoe, et al. 544)

*Nelson Chemistry 11, Ontario Edition* (Jenkins, et al. 538)

*Nelson Chemistry 12, Ontario Edition* (van Kessel, et al. 11)

*Nelson Chemistry 12, College Preparation, Ontario Edition* (Davies, et al. 188)

*Prentice Hall Chemistry: Connections to Our Changing World* (LeMay, et al. 817)

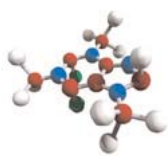

## SPECIFIC LEARNING OUTCOME

**C11-5-11:** Outline the transformation of alkenes to alkynes and vice versa.

Include: dehydrogenation/hydrogenation, molecular models

(0.5 hour)

SLO: C11-5-11

## SUGGESTIONS FOR INSTRUCTION

**Entry-Level Knowledge**

Students are now familiar with the structure of alkanes and alkenes, as well as the transformation processes of dehydrogenation and hydrogenation. They should also be familiar with the arrangement of electrons around the carbon atom in single and double bonds.

Students may remember nitrogen from Grade 10 Science, where they encountered the sharing of electrons within the nitrogen diatomic molecule to establish a stable octet of electrons for each nitrogen atom.



It should not be much of a surprise that triple bonds also occur in organic compounds.

**TEACHER NOTES**

The following information is meant as background for teachers; however, teachers may wish to provide students with some of this historical information.

The manufacture of the first member of this new homologous series of hydrocarbons, *acetylene*, is very important to manufacturing and construction due to the use of this gas in the process of oxy-acetylene welding. Enormous quantities of this gas are consumed each year.

Acetylene gas is derived from pressurized tanks of acetone. It is sold as a fuel for welding. It is also the organic starting material for the large-scale synthesis of a number of important organic compounds, including acetic acid, and a number of unsaturated compounds that are used in the manufacture of plastics and synthetic rubber.

**General Learning Outcome Connections**

**GLO D3:** Understand the properties and structures of matter, as well as various common manifestations and applications of the actions and interactions of matter.

**GLO E3:** Recognize that characteristics of materials and systems can remain constant or change over time, and describe the conditions and processes involved.

**SKILLS AND ATTITUDES OUTCOMES**

**C11-0-U1:** Use appropriate strategies and skills to develop an understanding of chemical concepts.

Examples: analogies, concept frames, concept maps, manipulatives, particulate representations, role-plays, simulations, sort-and-predict frames, word cycles...

**C11-0-R1:** Synthesize information obtained from a variety of sources.

Include: print and electronic sources, specialists, other resource people

Although acetylene was discovered by Edmund Davy in 1836, and much of the research was accomplished by Marcelin Berthelot, it was not until the French chemist Ferdinand Frederick Henri Moissan invented the electric furnace and was able to produce calcium carbide on a large scale that acetylene could become an important industrial chemical. Many of the synthetic uses of acetylene resulted from the work done in Germany before, during, and after the Second World War by W. Reppe. Research with this compound was accelerated by the lack of crude petroleum resources in Germany. The hope was that this compound might replace petroleum as a fuel. Much of the research that was done revolutionized the industrial chemistry of acetylene.

**Demonstration**

Perform an “underwater fireworks” demonstration. In this demonstration, chlorine gas is bubbled into a graduated cylinder in which acetylene gas is also being generated. When the bubbles interact, the gases ignite, with sparkling results. For the complete procedure, see Appendix 5.1: Underwater Fireworks.

**TEACHER NOTES**

The manufacture of acetylene can be accomplished by the reaction of water on calcium carbide,  $\text{CaC}_2$ . This compound is manufactured by the simple reaction of calcium oxide and coal under high temperatures. An alternative synthesis is based on the high temperature partial oxidation of methane.



Teachers will remember that, similar to the preparation of higher alkenes, higher alkynes are manufactured by the dehydrohalogenation of alkyl halides.

The reverse process is much less complex. An alkyne can readily be transformed into an alkane.

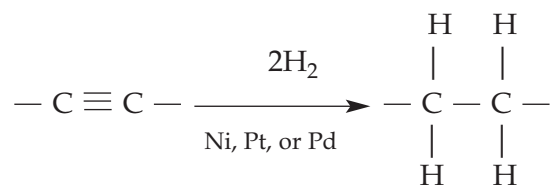

Hydrogenation under different conditions produces an alkene; however, two forms of the alkene are produced, the *cis* and the *trans* forms.

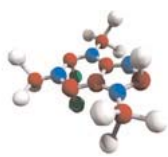

#### SPECIFIC LEARNING OUTCOME

**C11-5-11:** Outline the transformation of alkenes to alkynes and vice versa.

Include: dehydrogenation/hydrogenation, molecular models

(continued)

---



#### SUGGESTIONS FOR ASSESSMENT

---

Students should gain an appreciation for the complexity of organic compounds and their reactions, but are not expected to memorize the transformations.

Any assessment that results from the discussion of the historical development of the alkynes and related topics will depend on the teacher and the amount of time taken with the discussion.

#### LEARNING RESOURCES LINKS

---



*Chemistry* (Chang 989)

*Chemistry* (Zumdahl and Zumdahl 1055)

*Chemistry: The Central Science* (Brown, et al. 997)

*Introductory Chemistry: A Foundation* (Zumdahl 592)

**SKILLS AND ATTITUDES OUTCOMES**

**C11-0-U1:** Use appropriate strategies and skills to develop an understanding of chemical concepts.

*Examples: analogies, concept frames, concept maps, manipulatives, particulate representations, role-plays, simulations, sort-and-predict frames, word cycles...*

**C11-0-R1:** Synthesize information obtained from a variety of sources.

Include: print and electronic sources, specialists, other resource people

---

**NOTES**

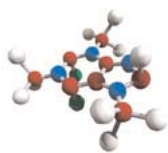

**SPECIFIC LEARNING OUTCOME**

**C11-5-12:** Name, draw, and construct structural models of alkynes and branched alkynes.

Include: six-carbon parent chain, methyl and ethyl substituent groups, IUPAC nomenclature, structural formulas, condensed structural formulas, molecular formulas, general formula  $C_nH_{2n-2}$

(1.5 hours)

SLO: C11-5-12

**SUGGESTIONS FOR INSTRUCTION****Entry-Level Knowledge**

Students were introduced to alkynes in learning outcome C11-5-04 where a brief comparison was made to identify differences in structure and relative physical properties. Students have also drawn members of the homologous series of both alkanes and alkenes, as well as branched structures and isomers. They should also understand the differences among molecular formulas, structural formulas, and condensed structural formulas.

**TEACHER NOTES**

Point out to students that the first member of the *alkyne* series must be a two-carbon molecule, namely ethyne, commonly known as acetylene.

With a general formula of  $C_nH_{2n-2}$ , students should realize that the number of hydrogen atoms will be two *less* than that observed for an alkene. In addition, every member of this series will contain a triple bond. Students should first draw structural formulas so they can more easily see an octet for each atom of carbon. The triple bond also reduces the number of hydrogen atoms associated with the carbon atoms connected to the double bond. Students should use the atomic model kits again to create examples of molecules for this learning outcome.

As students draw and construct ethyne, propyne, and so on, they will appreciate the structure of the compounds and the position of the hydrogen atoms around the molecule. When students progress in the series to butyne, they will realize that butane has two different isomers, having different names.

Students should be able to name alkynes up to and including six-carbon parent chains: ethyne, propyne, butyne, pentyne, and hexyne.

Students have already had experience with branching alkanes and alkenes and so the replacement of a triple bond for the double bond should not present difficulty, provided they have carefully learned the system of naming up to this point.

**General Learning Outcome Connections**

**GLO D1:** Understand essential life structures and processes pertaining to a wide variety of organisms, including humans.

**GLO E2:** Describe and appreciate how the natural and constructed world is made up of systems and how interactions take place within and among these systems.

**SKILLS AND ATTITUDES OUTCOMES**

**C11-0-U1:** Use appropriate strategies and skills to develop an understanding of chemical concepts.

*Examples: analogies, concept frames, concept maps, manipulatives, particulate representations, role-plays, simulations, sort-and-predict frames, word cycles...*

**C11-0-R1:** Synthesize information obtained from a variety of sources.

Include: print and electronic sources, specialists, other resource people

Note that mixed double- and triple-bond compounds should not be introduced, nor should the concepts of dienes, trienes, diynes, and triynes.

*Examples:*

The following examples illustrate the naming of branched alkynes.

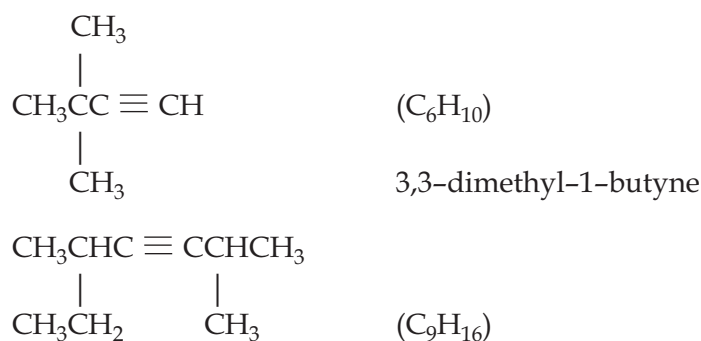

This example is using a clever technique, as the longest parent chain is 7, making the correct name:

2,5-dimethyl-3-heptyne

Remind students that in 3-D space, molecules look quite different. This presents a further argument for having students use molecular models to appreciate the 3-D configuration of branched organic molecules.



## SUGGESTIONS FOR ASSESSMENT

Teachers who have taken organic chemistry understand how complex the naming of organic compounds can easily become. Try to make the learning experiences related to this brief introduction to organic chemistry as positive as possible. Students who demonstrate a particular interest in organic chemistry may wish to increase the scope of the challenge by naming and/or drawing more complex structures. However, these extensions should be clearly identified as being optional, for enriched learning, and perhaps useful for those planning advanced study options.

### Paper-and-Pencil Tasks

Students should be able to provide the correct names for various alkynes and branched alkynes when given the condensed structural formulas. Conversely, they should be able to draw a molecule from its name.

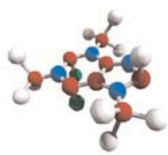
**SPECIFIC LEARNING OUTCOME**

**C11-5-12:** Name, draw, and construct structural models of alkynes and branched alkynes.

Include: six-carbon parent chain, methyl and ethyl substituent groups, IUPAC nomenclature, structural formulas, condensed structural formulas, molecular formulas, general formula  $C_nH_{2n-2}$

(continued)

---

**Laboratory Test**

If atomic model sets are available, have students review the homologous series of hydrocarbons that have been studied so far by giving them a lab test. Arrange various molecules around the lab and give students a short period of time to identify the structure and write the correct name for a molecule before moving to the next molecule.

**Journal Writing**

Have students write journal entries about their impressions of organic chemistry. They may also want to comment on the number of compounds.

**LEARNING RESOURCES LINKS**

---



*Chemistry* (Chang 991)

*Chemistry* (Zumdahl and Zumdahl 1054)

*Chemistry: The Central Science* (Brown, et al. 996)

*Chemistry: Concepts and Applications* (Phillips, Strozak, and Wistrom 325)

*Chemistry: The Molecular Nature of Matter and Change* (Silberberg 621)

*Glencoe Chemistry: Matter and Change* (Dingrando, et al. 711)

*Introductory Chemistry: A Foundation* (Zumdahl 590)

*McGraw-Hill Ryerson Chemistry, Combined Atlantic Edition* (Mustoe, et al. 354)

*McGraw-Hill Ryerson Chemistry 11, Ontario Edition* (Mustoe, et al. 560)

*Nelson Chemistry 11, Ontario Edition* (Jenkins, et al. 543)

*Nelson Chemistry 12, Ontario Edition* (van Kessel, et al. 16)

*Nelson Chemistry 12, College Preparation, Ontario Edition* (Davies, et al. 184)

*Prentice Hall Chemistry: Connections to Our Changing World* (LeMay, et al. 825)

**SKILLS AND ATTITUDES OUTCOMES**

**C11-0-U1:** Use appropriate strategies and skills to develop an understanding of chemical concepts.

*Examples: analogies, concept frames, concept maps, manipulatives, particulate representations, role-plays, simulations, sort-and-predict frames, word cycles...*

**C11-0-R1:** Synthesize information obtained from a variety of sources.

Include: print and electronic sources, specialists, other resource people

---

**NOTES**

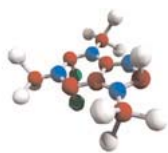
**SPECIFIC LEARNING OUTCOME**

**C11-5-13:** Compare and contrast the structure of aromatic and aliphatic hydrocarbons.

Include: molecular models, condensed structural formulas

(0.5 hour)

SLO: C11-5-13

**SUGGESTIONS FOR INSTRUCTION****Entry-Level Knowledge**

Other than knowing the non-organic meaning of aromatic, students will have no prior knowledge of aromatic hydrocarbons. Some students will know that an aromatic substance produces a strong odour. In fact, it was this description that originally set aromatics apart from their aliphatic relatives.

**TEACHER NOTES**

The name *aromatic* originated from the pleasant odour of many naturally occurring compounds. Benzene and its derivatives were produced from a number of odorous aromatic balsams and resins. The name *aliphatic* originally applied to substances derived from fatty acid sources, hence the name (Greek *aleiphatos*, fat). These names provide the basis for nomenclature of the two branches of organic chemistry: *aliphatic* and *aromatic*. Aromatics are associated with benzene and its derivatives, whereas aliphatics are essentially straight-chain compounds, with the exception of some cyclic-aliphatics, such as cyclopropane and cyclopentane.

Aliphatic and aromatic compounds are similar in that they are hydrocarbon compounds containing hydrogen atoms attached to carbon atoms and maintain the stable octet electronic structure for carbon. Both groups of compounds are generally flammable, having relatively low boiling points.

However, the unsaturated benzene compounds, besides having a different structure, do not react the same as aliphatic olefin compounds.

There are a multitude of references to the fascinating “story” of how the cyclic structure of compounds such as benzene was determined. Pursue this historical vignette with students.

**General Learning Outcome Connections**

- GLO A2:** Recognize that scientific knowledge is based on evidence, models, and explanations, and evolves as new evidence appears and new conceptualizations develop.
- GLO A4:** Identify and appreciate contributions made by women and men from many societies and cultural backgrounds that have increased our understanding of the world and brought about technological innovations.
- GLO B1:** Describe scientific and technological developments—past and present—and appreciate their impact on individuals, societies, and the environment, both locally and globally.
- GLO D3:** Understand the properties and structures of matter, as well as various common manifestations and applications of the actions and interactions of matter.

**SKILLS AND ATTITUDES OUTCOMES**

**C11-0-U1:** Use appropriate strategies and skills to develop an understanding of chemical concepts.

Examples: analogies, concept frames, concept maps, manipulatives, particulate representations, role-plays, simulations, sort-and-predict frames, word cycles...

**C11-0-R1:** Synthesize information obtained from a variety of sources.

Include: print and electronic sources, specialists, other resource people

**Historical Background**

The discovery of benzene and its structure was both an interesting and a significant milestone in organic chemistry. Michael Faraday first isolated this remarkable substance in 1825. He discovered the compound in the oily condensate that collected in the illuminating gas lines of London, England. Faraday established its empirical formula as  $\text{CH}$  and called it *carburetted hydrogen*. The actual molecular formula of  $\text{C}_6\text{H}_6$  was determined by Eilhard Mitscherlich in 1834 by heating gum benzoin with lime. The structural formula of this compound presented a much greater challenge than that of other organic compounds. Its molecular formula suggested it was unsaturated; however, it did not react like other unsaturated hydrocarbons. In fact, it was remarkably stable.

It was not until 1865 that the German chemist Friedrich August Kekulé von Stradonitz (usually known to us simply as Kekulé) proposed a structure for benzene that explained its chemical behaviour. He proposed a cyclic hexagonal structure of six-carbon atoms with alternate double and single bonds. Each carbon atom was bonded to only one hydrogen atom.

After further experimentation by other scientists, Kekulé modified his structure to reflect the additional information. In the diagrams below, the double bond is between carbons 2 and 3. Kekulé proposed that the double bonds oscillate or resonate between carbon atoms 2 and 1. Similarly, the other double bonds would resonate between the other carbon atoms, as illustrated.

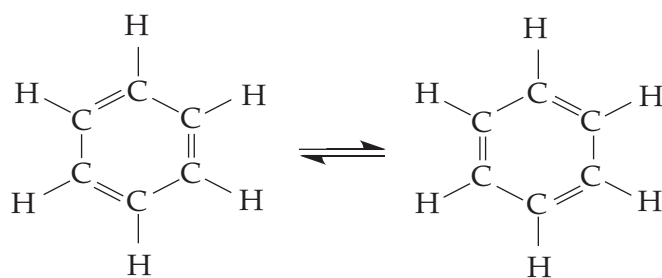

**Kekulé Structure**

These two energetically equal structures are called *resonance hybrids*. The actual structure is believed to be somewhere between these two structures.

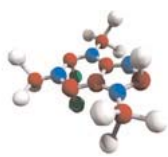

### SPECIFIC LEARNING OUTCOME

**C11-5-13:** Compare and contrast the structure of aromatic and aliphatic hydrocarbons.

Include: molecular models, condensed structural formulas

(continued)

---



For additional information, see the following websites:

Doc Brown's Chemistry Clinic:

<<http://www.wpbschoolhouse.btinternet.co.uk/page06/FunctionalGroups.htm>>

Rod Beavon. F A Kekulé von Stradonitz:

<<http://www.rod.beavon.clara.net/kekule.htm>>



### SUGGESTIONS FOR ASSESSMENT

---

#### Research Reports

If sufficient time is available, have students research and report on the work done by Kekulé and others to determine the structure of benzene. The information collected could be presented as

- written reports
- oral presentations
- bulletin board displays

#### Visual Displays

Students could present the material they have collected using

- posters
- pamphlets
- bulletin boards
- models

Each of these presentation styles could be assessed using an appropriate rubric created with students prior to the assignment. Samples of presentation rubrics are provided in Appendix 10 of this document.

#### Journal Writing

Have students comment on the structure of benzene that Kekulé proposed.

### SKILLS AND ATTITUDES OUTCOMES

**C11-0-U1:** Use appropriate strategies and skills to develop an understanding of chemical concepts.

*Examples: analogies, concept frames, concept maps, manipulatives, particulate representations, role-plays, simulations, sort-and-predict frames, word cycles...*

**C11-0-R1:** Synthesize information obtained from a variety of sources.

Include: print and electronic sources, specialists, other resource people

---

### LEARNING RESOURCES LINKS

---



*Chemistry* (Chang 993)

*Chemistry* (Zumdahl and Zumdahl 1055)

*Chemistry: The Central Science* (Brown, et al. 1000)

*Chemistry: Concepts and Applications* (Phillips, Strozak, and Wistrom 636)

*Chemistry: The Molecular Nature of Matter and Change* (Silberberg 622)

*Glencoe Chemistry: Matter and Change* (Dingrando, et al. 722)

*Introductory Chemistry: A Foundation* (Zumdahl 592)

*McGraw-Hill Ryerson Chemistry, Combined Atlantic Edition* (Mustoe, et al. 357)

*McGraw-Hill Ryerson Chemistry 11, Ontario Edition* (Mustoe, et al. 561)

*Nelson Chemistry 11, Ontario Edition* (Jenkins, et al. 508)

*Nelson Chemistry 12, Ontario Edition* (van Kessel, et al. 19)

*Prentice Hall Chemistry: Connections to Our Changing World* (LeMay, et al. 824)

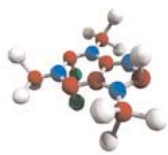

**SPECIFIC LEARNING OUTCOME****C11-5-14:** Describe uses of aromatic hydrocarbons.

*Examples: polychlorinated biphenyls, caffeine, steroids, organic solvents (toluene, xylene)...*

**(1.0 hour)****SLO: C11-5-14****SUGGESTIONS FOR INSTRUCTION****Entry-Level Knowledge**

Students would likely have no previous knowledge of the uses of benzene.

**TEACHER NOTES**

The discovery of benzene and its unique structure and properties spawned a new industry solely focused on the manufacture of benzene and its derivatives. As students research this topic using the Internet, or print resources provided by the teacher, they will quickly appreciate the toxicity of most aromatic derivatives of benzene. Even though such compounds have high toxicity, they are essential to the manufacture of nylon and plastic products upon which we rely so much.

It is of interest that Michael Faraday – more widely known for his contributions to electromagnetism – first isolated benzene in 1825 by compressing oil gas, the lightest fraction of hydrocarbons produced by the distillation of coal tar. This was well ahead of any attempts to understand the molecular characteristics of benzene.

**STSE Issues**

Many STSE issues could be included in class discussion of benzene and its derivatives. Questions such as the following could be used to initiate discussion regarding the use and disposal of aromatic hydrocarbons:

- How toxic are benzene and its derivatives?
- How important are plastics and synthetic rubber products in our lives?
- How necessary are these products?
- How necessary are these toxic solvents to the manufacture of plastics and synthetic rubber products?
- Where are the majority of these products manufactured?

**General Learning Outcome Connections**

**GLO A5:** Recognize that science and technology interact with and advance one another.

**GLO B3:** Identify the factors that affect health, and explain the relationships among personal habits, lifestyle choices, and human health, both individual and social.

**GLO B5:** Identify and demonstrate actions that promote a sustainable environment, society, and economy, both locally and globally.

**GLO E2:** Describe and appreciate how the natural and constructed world is made up of systems and how interactions take place within and among these systems.

**SKILLS AND ATTITUDES OUTCOMES**

**C11-0-U1:** Use appropriate strategies and skills to develop an understanding of chemical concepts.

*Examples: analogies, concept frames, concept maps, manipulatives, particulate representations, role-plays, simulations, sort-and-predict frames, word cycles...*

**C11-0-R1:** Synthesize information obtained from a variety of sources.

Include: print and electronic sources, specialists, other resource people

- What is the primary workforce that is employed in the manufacture of plastic products?
- What safety precautions are necessary for the safety of the workers in this industry?
- How are anabolic steroids used by society?
- What adverse effects are known for caffeine?
- Is caffeine addictive?
- How are polychlorinated biphenyls (PCBs) used today?
- What safety precautions are in place to dispose of PCBs?
- Where are toxic wastes stored in Canada?
- Where are toxic wastes stored in Manitoba?

**Online Research**

The actual physical structures for the aromatic hydrocarbon compounds suggested in this learning outcome (e.g., caffeine) are not given here, as they are readily available from most texts and from online sources.

What follows are some suggested starting points for online research.

Connecticut Department of Environmental Protection. PCBs:

<<http://dep.state.ct.us/wst/pcb/pcbindex.htm>>

This website provides information on the history of the uses of polychlorinated biphenyls.

eMedicine (from WebMD). Toxicity, Toluene:

<<http://www.emedicine.com/emerg/topic594.htm>>

Toluene is a widely used solvent, but poses significant risks to human health, upon exposure. This website provides an abundance of detail, and includes information related to health chemistry or human biology contexts.

Greener Industry: <<http://www.greener-industry.org/>>

This UK website highlights many of the current industrial uses of benzene, including world production statistics. “Mouse over” the links to “benzene” for many detailed web pages.

Iowa Health System (IHS). Drug: Anabolic Steroids:

<<http://www.ihs.org/body.cfm?id=580>>

This is a brief fact sheet on the uses (and street terminologies) associated with teen use of anabolic steroids.

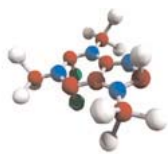

**SPECIFIC LEARNING OUTCOME**

**C11-5-14:** Describe uses of aromatic hydrocarbons.

*Examples: polychlorinated biphenyls, caffeine, steroids, organic solvents (toluene, xylene)...*

(continued)

---

Material Safety Data Sheet (MSDS). Toluene:

<<http://www.jtbaker.com/msds/englishhtml/t3913.htm>>

Teachers may wish to bookmark this website for further reference to other MSDS information.

U.S. Environmental Protection Agency. Software for Environmental Awareness:

<<http://www.epa.gov/seahome/hwaste.html>>

This website offers teachers and students the opportunity to run simulations using free-use software provided by EPA. It can be used to simulate how to control hazardous wastes around the home.

Virginia Commonwealth University. Steroids – Introduction:

<<http://www.people.vcu.edu/~urdesai/intro.htm#Structure>>

This website addresses, in a rather sophisticated manner, the structural chemistry of various steroid molecules (e.g., progesterone, testosterone, cholesterol).

Webshells.com. Oil, Chemical and Atomic Workers Union (OCAW). Benzene:

<<http://www.webshells.com/ocaw/txts/doc999994.htm>>

This website addresses the human health risks associated with the use of benzene. It contains a short essay on benzene – what it is, its uses, and its associated hazards.

The WELL. Web of Addictions. Steroids:

<<http://www.well.com/user/woa/fsroids.htm>>

This is a fact sheet on the treatment of steroids by the Missouri Department of Mental Health, Division of Alcohol and Drug Abuse.

York University. The Chemistry Hall of Fame. Benzene: The Parent Aromatic Compound:

<[http://www.chem.yorku.ca/hall\\_of\\_fame/essays97/benzene/benzene.htm](http://www.chem.yorku.ca/hall_of_fame/essays97/benzene/benzene.htm)>

This essay is a contribution to an award-winning secondary-level student essay contest.

**SKILLS AND ATTITUDES OUTCOMES**

**C11-0-U1:** Use appropriate strategies and skills to develop an understanding of chemical concepts.

*Examples: analogies, concept frames, concept maps, manipulatives, particulate representations, role-plays, simulations, sort-and-predict frames, word cycles...*

**C11-0-R1:** Synthesize information obtained from a variety of sources.

Include: print and electronic sources, specialists, other resource people

---

**SUGGESTIONS FOR ASSESSMENT**

---

**Research Reports**

Have students conduct research and report their findings either individually or in small groups. The information collected could be presented as

- written reports
- oral presentations
- bulletin boards
- multimedia

**Visual Displays**

Students could present the material they have collected using

- posters
- pamphlets
- bulletin boards
- models

Each of these presentation styles could be assessed using an appropriate rubric created with students prior to the assignment. Samples of presentation rubrics are provided in Appendix 10 of this document.

**Discussion Formats**

Several optional formats could be used to discuss issues related to the use and disposal of aromatic hydrocarbons:

- town hall meeting
- courtroom arguments over a lawsuit
- public inquiry into pollution issues caused by a local industry

**Journal Writing**

Many controversial issues are related to this learning outcome, so it should not be difficult to encourage students to write a journal entry.

**Paper-and-Pencil Tasks**

This learning outcome serves as a focus for student concern for the environment and the issues regarding the use and disposal of toxic materials. Ask students for opinions, suggestions, and decisions. The structure of these compounds should not be emphasized.

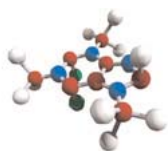

### SPECIFIC LEARNING OUTCOME

**C11-5-14:** Describe uses of aromatic hydrocarbons.

*Examples: polychlorinated biphenyls, caffeine, steroids, organic solvents (toluene, xylene)...*

(continued)

### Did You Know?

In the storyline of *Sahara*, an action/adventure movie based on a novel by Clive Cussler, toxic waste has begun to pollute the waters of the Niger River in Africa, and the heroes in the film are the antagonists of the polluters.

### LEARNING RESOURCES LINKS



*Chemistry* (Chang 502 – toluene)

*Chemistry: The Central Science* (Brown, et al. 437 – toluene, 519 – caffeine)

*Chemistry: Concepts and Applications* (Phillips, Strozak, and Wistrom 686 – steroids)

*Chemistry: The Molecular Nature of Matter and Change* (Silberberg 566, 591 – PCBs, 622 – toluene)

*Glencoe Chemistry: Matter and Change* (Dingrando, et al. 787)

*Introductory Chemistry: A Foundation* (Zumdahl 642 – steroids)

*McGraw-Hill Ryerson Chemistry, Combined Atlantic Edition* (Mustoe, et al. 356 – steroids)

*McGraw-Hill Ryerson Chemistry 11, Ontario Edition* (Mustoe, et al. 561 – steroids)

*Nelson Chemistry 12, Ontario Edition* (van Kessel, et al. 19 – toluene, 32 – PCBs, 54 – steroids, 80 – caffeine)

*Nelson Chemistry 12, College Preparation, Ontario Edition* (Davies, et al. 214)

*Prentice Hall Chemistry: Connections to Our Changing World* (LeMay, et al. 880)

**SKILLS AND ATTITUDES OUTCOMES**

**C11-0-U1:** Use appropriate strategies and skills to develop an understanding of chemical concepts.

*Examples: analogies, concept frames, concept maps, manipulatives, particulate representations, role-plays, simulations, sort-and-predict frames, word cycles...*

**C11-0-R1:** Synthesize information obtained from a variety of sources.

Include: print and electronic sources, specialists, other resource people

---

**NOTES**

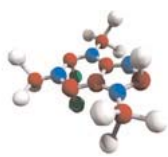
**SPECIFIC LEARNING OUTCOMES**

**C11-5-15:** Write condensed structural formulas for and name common alcohols.

Include: maximum of six-carbon parent chain, IUPAC nomenclature

**C11-5-16:** Describe uses of methyl, ethyl, and isopropyl alcohols.

(0.5 hour)

SLO: C11-5-15  
SLO: C11-5-16

**SUGGESTIONS FOR INSTRUCTION****Entry-Level Knowledge**

Students should, by this point, know the names of methanol, ethanol, and isopropyl alcohols. They may also know other names for these alcohols and some information about the fermentation process for the production of ethyl alcohol.

Students are already aware of the uses of numerical and Greek prefixes for chain length when naming organic compounds.

**Assessing Prior Knowledge**

Check for student understanding of prior knowledge and review as necessary. Prior knowledge can be reviewed and/or assessed by using any of the KWL strategies (e.g., Concept Map, Knowledge Chart, Think-Pair-Share—see *SYSTH*, Chapter 9).

**TEACHER NOTES**

Students should know the common, the derived, and the IUPAC names for methanol, ethanol, and isopropyl alcohol.

R — OH	general case, where R is any parent chain
CH <sub>3</sub> OH	methanol, methyl alcohol, wood alcohol
CH <sub>3</sub> CH <sub>2</sub> OH	ethanol, ethyl alcohol, grain alcohol
$\begin{array}{c} \text{CH}_3\text{CHOH} \\   \\ \text{CH}_3 \end{array}$	2-propanol, isopropyl alcohol, rubbing alcohol

**General Learning Outcome Connections**

- GLO B1:** Describe scientific and technological developments—past and present—and appreciate their impact on individuals, societies, and the environment, both locally and globally.
- GLO B3:** Identify the factors that affect health, and explain the relationships among personal habits, lifestyle choices, and human health, both individual and social.
- GLO D3:** Understand the properties and structures of matter, as well as various common manifestations and applications of the actions and interactions of matter.

**SKILLS AND ATTITUDES OUTCOMES**

**C11-0-U1:** Use appropriate strategies and skills to develop an understanding of chemical concepts.

*Examples: analogies, concept frames, concept maps, manipulatives, particulate representations, role-plays, simulations, sort-and-predict frames, word cycles...*

**C11-0-S1:** Demonstrate work habits that ensure personal safety and the safety of others, as well as consideration for the environment.

Include: knowledge and use of relevant safety precautions, Workplace Hazardous Materials Information System (WHMIS), emergency equipment

**C11-0-R1:** Synthesize information obtained from a variety of sources.

Include: print and electronic sources, specialists, other resource people

**C11-0-C1:** Collaborate with others to achieve group goals and responsibilities.

Inform students of the uses of these alcohols as well. Students should gain familiarity with other alcohol compounds up to and including hexanol. At this level of study, it is preferred that teachers limit the number of side chains and give examples of single alcohol units only (i.e., no diols).

Several examples are provided below for information. Tell students that the alcohol or hydroxyl radical  $-OH$  takes precedence over numbering. The following molecule is numbered to make the carbon atom to which the  $-OH$  is attached the smallest.

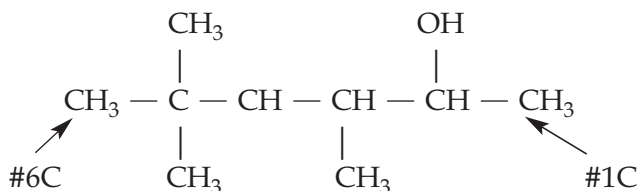

3, 5, 5-trimethyl-2-hexanol

Students will need use this knowledge in the study and preparation of esters (learning outcomes C11-5-19 to C11-5-21). Rather than placing the emphasis on drawing structural diagrams of alcohol compounds, concentrate primarily on nomenclature, characteristics, and applications of certain alcohols.

**SUGGESTIONS FOR ASSESSMENT****Research Reports**

Teachers may wish to have students research information about the various common alcohols or the production of alcohols. Students have not yet encountered the fermentation process in the production of ethanol. Have students research and report their findings individually or in small groups.

The information collected could be presented as

- written reports
- oral presentations
- bulletin board displays
- multimedia presentations

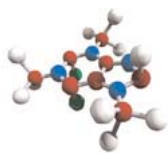

**SPECIFIC LEARNING OUTCOMES**

**C11-5-15:** Write condensed structural formulas for and name common alcohols.

Include: maximum of six-carbon parent chain, IUPAC nomenclature

**C11-5-16:** Describe uses of methyl, ethyl, and isopropyl alcohols.

(continued)

---

**Visual Displays**

Students could present the material they have collected using

- posters
- pamphlets
- bulletin boards
- models

Each of these presentation styles could be assessed using an appropriate rubric created with students prior to the assignment. Samples of presentation rubrics are provided in Appendix 10 of this document.

**Laboratory Reports**

The lab activities for this learning outcome could be assessed as formal lab reports using the Laboratory Report Outline or the Laboratory Report Format (see *SYSTH* 11.38, 14.12) or by using questions and answers from the data collected from the activities.

**Journal Writing**

Teachers may want students to write journal entries regarding alcohols.

**Paper-and-Pencil Tasks**

Students should write names for and draw condensed structural formulas for six-carbon parent chain alcohols.

**LEARNING RESOURCES LINKS**

---



*Chemistry* (Chang 996)

*Chemistry* (Zumdahl and Zumdahl 1058)

*Chemistry: The Central Science* (Brown, et al. 1003)

*Chemistry: The Molecular Nature of Matter and Change* (Silberberg 628)

*Glencoe Chemistry: Matter and Change* (Dingrando, et al. 743)

*Introductory Chemistry: A Foundation* (Zumdahl 598)

*Nelson Chemistry 12, Ontario Edition* (van Kessel, et al. 38)

*Nelson Chemistry 12, College Preparation, Ontario Edition* (Davies, et al. 204)

*Prentice Hall Chemistry: Connections to Our Changing World* (LeMay, et al. 841)

**SKILLS AND ATTITUDES OUTCOMES**

**C11-0-U1:** Use appropriate strategies and skills to develop an understanding of chemical concepts.

*Examples: analogies, concept frames, concept maps, manipulatives, particulate representations, role-plays, simulations, sort-and-predict frames, word cycles...*

**C11-0-S1:** Demonstrate work habits that ensure personal safety and the safety of others, as well as consideration for the environment.

Include: knowledge and use of relevant safety precautions, Workplace Hazardous Materials Information System (WHMIS), emergency equipment

**C11-0-R1:** Synthesize information obtained from a variety of sources.

Include: print and electronic sources, specialists, other resource people

**C11-0-C1:** Collaborate with others to achieve group goals and responsibilities.

---

**NOTES**

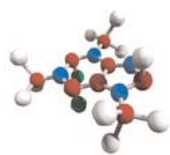
**SPECIFIC LEARNING OUTCOMES**

**C11-5-17:** Write condensed structural formulas for and name organic acids.

Include: maximum of six-carbon parent chain, IUPAC nomenclature

**C11-5-18:** Describe uses or functions of common organic acids.

Examples: acetic, ascorbic, citric, formic, acetylsalicylic (ASA), lactic...

(0.5 hour)

SLO: C11-5-17  
SLO: C11-5-18

**SUGGESTIONS FOR INSTRUCTION**
**Entry-Level Knowledge**

Students will not know the formula of organic acids but they will certainly recognize vinegar or acetic acid if they have ever eaten fish and chips.

**TEACHER NOTES**

Provide students with the general formula for organic acids. This will help them understand the reaction between organic acids and alcohols to form esters, which will be addressed in the next series of learning outcomes.

Organic acids can be represented by a general formula:

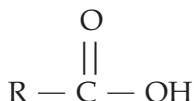

In biology this would most likely be written as RCOOH where R represents any hydrocarbon, not unlike algebra where  $x$  can represent any integer.

The functional group  $\overset{\text{O}}{\parallel} \text{C} - \text{OH}$  or  $-\text{COOH}$  is known as the carboxyl group.

The simplest organic acid or carboxylic acid contains 1C:

methanoic acid	HCOOH	formic acid
ethanoic acid	CH <sub>3</sub> COOH	acetic acid
propanoic acid	CH <sub>3</sub> CH <sub>2</sub> COOH	
butanoic acid	CH <sub>3</sub> CH <sub>2</sub> CH <sub>2</sub> COOH	

**General Learning Outcome Connections**

**GLO B3:** Identify the factors that affect health, and explain the relationships among personal habits, lifestyle choices, and human health, both individual and social.

**GLO D3:** Understand the properties and structures of matter, as well as various common manifestations and applications of the actions and interactions of matter.

**SKILLS AND ATTITUDES OUTCOMES**

**C11-0-U1:** Use appropriate strategies and skills to develop an understanding of chemical concepts.

*Examples: analogies, concept frames, concept maps, manipulatives, particulate representations, role-plays, simulations, sort-and-predict frames, word cycles...*

**C11-0-R1:** Synthesize information obtained from a variety of sources.

Include: print and electronic sources, specialists, other resource people

Students can easily see that the root word has not changed but the suffix has become *oic* once the “e” has been dropped from methane, ethane, propane, and butane.

Compounds for which the functional group is located in positions other than in the “n” (or normal) position are not included in Grade 11 Chemistry.

Teachers have the option of giving students the condensed structural formulas for the carboxylic acid derivatives suggested in the examples (ascorbic, lactic, etc.) for learning outcome C11-5-18, but should not expect students to memorize these formulas.

Formic acid is found in the nervous system of most species of ants (hence the name *antacid*). Teachers have the choice of providing students with the uses or functions of these acids or having students find the information themselves, using their chemistry text or some other resource. The examples specified in the learning outcome are only suggestions and so other examples could be used.

**Model-Building Activity**

Atomic models could be used to help students gain an appreciation for the 3-D structure of the carboxylic acids, as well as for the other families of organic compounds.

**SUGGESTIONS FOR ASSESSMENT**

Because both alcohols and carboxylic acids are the reactants for the production of esters, it is important that students understand these compounds so they can more clearly understand the ester lab activity suggested for learning outcomes C11-5-19 to C11-5-21.

**Paper-and-Pencil Tasks**

Remind students that the carbon atom (C) in COOH is counted as *one of the parent chain C atoms*. When providing student learning activities, combine both acids and alcohols, and reverse the lettering direction of the alcohol and/or the carboxylic acid as follows:

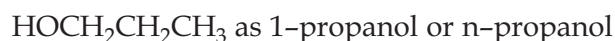

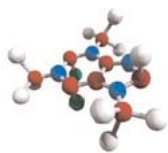

### SPECIFIC LEARNING OUTCOMES

**C11-5-17:** Write condensed structural formulas for and name organic acids.

Include: maximum of six-carbon parent chain, IUPAC nomenclature

**C11-5-18:** Describe uses or functions of common organic acids.

Examples: acetic, ascorbic, citric, formic, acetylsalicylic (ASA), lactic...

(continued)

---

### LEARNING RESOURCES LINKS

---



*Chemistry* (Chang 999)

*Chemistry* (Zumdahl and Zumdahl 1061)

*Chemistry: The Central Science* (Brown, et al. 1005)

*Chemistry: Concepts and Applications* (Phillips, Strozak, and Wistrom 642)

*Chemistry: The Molecular Nature of Matter and Change* (Silberberg 636)

*Glencoe Chemistry: Matter and Change* (Dingrando, et al. 749)

*Introductory Chemistry: A Foundation* (Zumdahl 605)

*McGraw-Hill Ryerson Chemistry, Combined Atlantic Edition* (Mustoe, et al. 405)

*Nelson Chemistry 12, Ontario Edition* (van Kessel, et al. 58)

*Nelson Chemistry 12, College Preparation, Ontario Edition* (Davies, et al. 218)

*Prentice Hall Chemistry: Connections to Our Changing World* (LeMay, et al. 852)

**SKILLS AND ATTITUDES OUTCOMES**

**C11-0-U1:** Use appropriate strategies and skills to develop an understanding of chemical concepts.

*Examples: analogies, concept frames, concept maps, manipulatives, particulate representations, role-plays, simulations, sort-and-predict frames, word cycles...*

**C11-0-R1:** Synthesize information obtained from a variety of sources.

Include: print and electronic sources, specialists, other resource people

---

**NOTES**

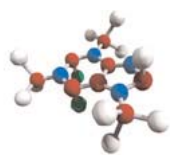
**SPECIFIC LEARNING OUTCOMES**

**C11-5-19:** Perform a lab involving the formation of esters, and examine the process of esterification.

**C11-5-20:** Write condensed structural formulas for and name esters.  
Include: up to 6-C alcohols and 6-C organic acids, IUPAC nomenclature

**C11-5-21:** Describe uses of common esters.

*Examples: pheromones, artificial flavourings...*

(2.0 hours)

SLO: C11-5-19  
SLO: C11-5-20  
SLO: C11-5-21

**SUGGESTIONS FOR INSTRUCTION****Entry-Level Knowledge**

Students will have no previous knowledge of or experience with the preparation of esters.

**TEACHER NOTES**

A lab procedure for the preparation of esters can be found in Appendix 5.2: Preparation of Esters. The odour from this lab can be irritating; however, the Material Safety Data Sheets for the esters produced do not indicate any adverse effects from the vapours of the resulting ester compounds. Nevertheless, if the lab has a poor circulation system, the lab activity should be performed in a fume hood. Alternatively, the activity could be done on warm days when classroom windows can be opened to ensure adequate ventilation.

The reaction, even with the catalyst concentrated sulphuric acid, is still slow. The addition of an excess amount of alcohol will usually force the equilibrium in the direction of the *products*, resulting in a slightly better yield for the ester. Instruct students to “waft” the odour toward them in the classical way to dilute the substance with air. Teachers who have done this lab activity know that the odours are not very distinct. Esters that can usually be identified include wintergreen and methyl salicylate. As the esters are oily and their densities are less than the density of water, they can be carefully poured into cold water in an evaporating dish to appreciate the odour better.

**General Learning Outcome Connections**

**GLO C2:** Demonstrate appropriate scientific inquiry skills when seeking answers to questions.

**GLO C3:** Demonstrate appropriate problem-solving skills when seeking solutions to technological challenges.

**GLO C7:** Work cooperatively and value the ideas and contributions of others while carrying out scientific and technological activities.

**GLO D3:** Understand the properties and structures of matter, as well as various common manifestations and applications of the actions and interactions of matter.

**GLO D6:** Understand the composition of the universe, the interactions within it, and the implications of humankind’s continued attempts to understand and explore it.

**GLO E1:** Describe and appreciate the similarity and diversity of forms, functions, and patterns within the natural and constructed world.

**SKILLS AND ATTITUDES OUTCOMES**

**C11-0-U1:** Use appropriate strategies and skills to develop an understanding of chemical concepts.

Examples: analogies, concept frames, concept maps, manipulatives, particulate representations, role-plays, simulations, sort-and-predict frames, word cycles...

**C11-0-R1:** Synthesize information obtained from a variety of sources.

Include: print and electronic sources, specialists, other resource people

Teachers will not want to use all the reactions, as the lab room would become so filled with the various odours that it would be very difficult, if not impossible, to identify any clear differences in the odours. Students generally say that the esters produced all smell the same. Teachers may wish to use different compounds each year until the results are satisfactory. Since only small amounts of each substance are used in the lab procedure, the acids and alcohols could be shared among schools, with obvious economic merit.

**Laboratory Activities**

1. The lab procedure described in Appendix 5.2: Preparation of Esters provides some of the more complex structures. Ensure that students complete the formulas contained in this activity prior to the lab. Encourage students to read the lab procedure very carefully, and consider any safety precautions. The hot water bath required to complete the reaction must be prepared before students begin to use flammable alcohols. Very hot water from the tap will often be satisfactory as a temperature bath.
2. A classroom-based organic molecule model-building activity can be used for review and reinforcement. For a sample procedure, see Appendix 5.3: Organic Model-Building Presentation.

**TEACHER NOTES**

The acidified reaction of an alcohol with a carboxylic acid to produce an ester is generally known as *Fischer esterification*. The reactions are reversible. At equilibrium, an appreciable amount of unreacted acid and alcohol may be present, producing a relatively large  $K_{eq}$ . Considering Le Châtelier's Principle, the equilibrium should be shifted to the right to produce more esters. In the Senior Years lab this can be accomplished by adding an excess of organic acid.

Investigations using primary alcohols containing isotopic oxygen-18 ( $O^{18}$ ) in the hydroxyl group have shown that the radioactive oxygen from the alcohols becomes part of the ester and not the water in the products. This is an interesting use of a radioactive tracer to follow the course of a reaction.

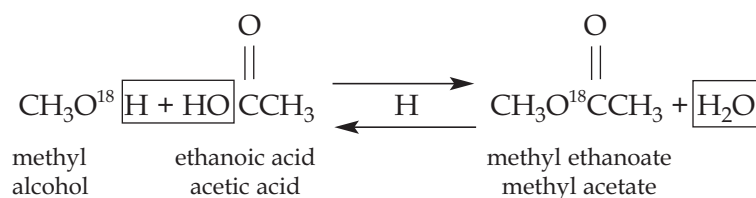

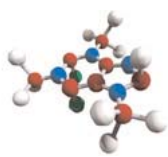

**SPECIFIC LEARNING OUTCOMES**

**C11-5-19:** Perform a lab involving the formation of esters, and examine the process of esterification.

**C11-5-20:** Write condensed structural formulas for and name esters.  
Include: up to 6-C alcohols and 6-C organic acids, IUPAC nomenclature

**C11-5-21:** Describe uses of common esters.

*Examples: pheromones, artificial flavourings...*

(continued)

**Formula of Esters**

The reactions for the lab experiment have already exposed students to the formula of esters. The esterification reactions also illustrate to students how the pieces are put together to form an ester. Provide students with the general formula for esters:

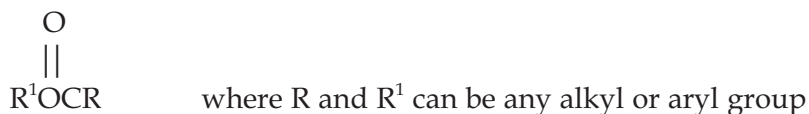
**Uses of Esters**

In addition to having flavour-enhancing properties, many esters are pheromones. A *pheromone* is a chemical substance that transmits information from one member of a species to another. In the case of insects, a virtual language exists between family members. Specific pheromones have been detected and analyzed. These pheromones may be used for diverse purposes such as marking a trail, warning of danger, attracting the opposite sex, or calling an assembly. The ester isopentyl acetate happens to be the alarm pheromone for the honeybee. Students will remember its characteristic odour resembling bananas when prepared in the lab. A more complete discussion can be found in Appendix 5.4: Esters: Flavours and Fragrances.

**TEACHER NOTES**

Inform students that, although the IUPAC naming system has been stressed, the conventions for naming esters often involve the common *names of both the alcohol and the carboxylic acid*. Alternate names are provided in the Sample Esters chart that follows.

**SKILLS AND ATTITUDES OUTCOMES**
**C11-0-U1:** Use appropriate strategies and skills to develop an understanding of chemical concepts.

*Examples: analogies, concept frames, concept maps, manipulatives, particulate representations, role-plays, simulations, sort-and-predict frames, word cycles...*
**C11-0-R1:** Synthesize information obtained from a variety of sources.

Include: print and electronic sources, specialists, other resource people

<b>Sample Esters</b>			
<b>Alcohol</b>	<b>Carboxylic Acid</b>	<b>Ester</b>	<b>Odour</b>
ethyl $\text{CH}_3\text{CH}_2\text{OH}$	butanoic butyric $\text{HO}-\overset{\text{O}}{\parallel}\text{CCH}_2\text{CH}_2\text{CH}_3$	ethyl butanoate ethyl butyrate $\text{CH}_3\text{CH}_2\text{OC}\overset{\text{O}}{\parallel}\text{CH}_2\text{CH}_2\text{CH}_3$	pineapple
Note that if the alcohol and acid are removed together and the water is removed as shown, the structure becomes the ester of the alcohol and acid. The oxygen in the ester comes from the alcohol.			
isopentyl (isoamyl) 3-methyl-1-butanol $\text{CH}_3\text{CH}(\text{CH}_3)\text{CH}_2\text{CH}_2\text{OH}$	acetic ethanoic $\text{HO}-\overset{\text{O}}{\parallel}\text{CCH}_3$	isopentyl acetate $\text{CH}_3\text{CH}(\text{CH}_3)\text{CH}_2\text{CH}_2\text{OC}\overset{\text{O}}{\parallel}\text{CH}_3$	banana
isobutyl 2-methyl-1-propanol $\text{CH}_3\text{CH}(\text{CH}_3)\text{CH}_2\text{OH}$	propionic propanoic $\text{HO}-\overset{\text{O}}{\parallel}\text{CCH}_2\text{CH}_3$	isobutyl propionate isobutyl propanoate $\text{CH}_3\text{CH}(\text{CH}_3)\text{CH}_2\text{OC}\overset{\text{O}}{\parallel}\text{CH}_2\text{CH}_3$	rum
n-octyl 1-octanol $\text{CH}_3(\text{CH}_2)_6\text{CH}_2\text{OH}$	acetic ethanoic $\text{HO}-\overset{\text{O}}{\parallel}\text{CCH}_3$	octyl acetate $\text{CH}_3(\text{CH}_2)_6\text{CH}_2\text{OC}\overset{\text{O}}{\parallel}\text{CH}_3$	orange
methyl methanol $\text{CH}_3\text{OH}$	butanoic butyric $\text{HO}-\overset{\text{O}}{\parallel}\text{CCH}_2\text{CH}_2\text{CH}_3$	methyl butanoate methyl butyrate $\text{CH}_3\text{OC}\overset{\text{O}}{\parallel}\text{CH}_2\text{CH}_2\text{CH}_3$	apple

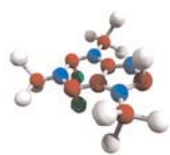

### SPECIFIC LEARNING OUTCOMES

**C11-5-19:** Perform a lab involving the formation of esters, and examine the process of esterification.

**C11-5-20:** Write condensed structural formulas for and name esters.  
Include: up to 6-C alcohols and 6-C organic acids, IUPAC nomenclature

**C11-5-21:** Describe uses of common esters

*Examples: pheromones, artificial flavourings...*

(continued)



### SUGGESTIONS FOR ASSESSMENT

---

By the end of learning outcomes C11-5-19 to C11-5-21, students should know that an ester can be prepared by the acidified reaction of an alcohol with a carboxylic acid in a process called esterification. They should be able to write the reaction for the formation of an ester, when given the names of the alcohol and the carboxylic acid, and they should be able to write the correct condensed structural formula for the ester and provide its correct name.

#### Paper-and-Pencil Tasks

The material presented in these learning outcomes could be assessed using an activity that begins with a question, complete with reactants, products, and all correct names and formulas. As the activity progresses, omit more and more information from the questions. By the last few questions, provide only the names of the reactants. A progressive exercise such as this enables students to develop their skill and knowledge of the material gradually.

#### Laboratory Reports

The lab activities for these learning outcomes could be assessed as formal lab reports using the Laboratory Report Outline or the Laboratory Report Format (see *SYSTH* 11.38, 14.12) or by using questions and answers from the data collected from the activities.

### SKILLS AND ATTITUDES OUTCOMES

**C11-0-U1:** Use appropriate strategies and skills to develop an understanding of chemical concepts.

*Examples: analogies, concept frames, concept maps, manipulatives, particulate representations, role-plays, simulations, sort-and-predict frames, word cycles...*

**C11-0-R1:** Synthesize information obtained from a variety of sources.

Include: print and electronic sources, specialists, other resource people

---

### LEARNING RESOURCES LINKS

---



*Chemistry* (Chang 1000)

*Chemistry* (Zumdahl and Zumdahl 1061)

*Chemistry: The Central Science* (Brown, et al. 1007)

*Chemistry: Concepts and Applications* (Phillips, Strozak, and Wistrom 643, plus ester lab)

*Chemistry: The Molecular Nature of Matter and Change* (Silberberg 637)

*Glencoe Chemistry: Matter and Change* (Dingrando, et al. 750)

*Introductory Chemistry: A Foundation* (Zumdahl 605)

*McGraw-Hill Ryerson Chemistry, Combined Atlantic Edition* (Mustoe, et al. 410, plus ester lab)

*Microscale Chemistry Laboratory Manual* (Slater and Rayner-Canham 82—ester lab)

*Nelson Chemistry 12, Ontario Edition* (van Kessel, et al. 65)

*Nelson Chemistry 12, College Preparation, Ontario Edition* (Davies, et al. 223, plus ester lab)

*Prentice Hall Chemistry: Connections to Our Changing World* (LeMay, et al. 855, plus ester lab)

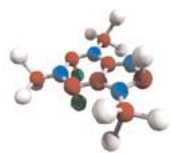
**SPECIFIC LEARNING OUTCOMES**

**C11-5-22:** Describe the process of polymerization and identify important natural and synthetic polymers.

*Examples: polyethylene, polypropylene, polystyrene, polytetrafluoroethylene (Teflon®)...*

**C11-5-23:** Describe how the products of organic chemistry have influenced quality of life.

*Examples: synthetic rubber, nylon, medicines, polytetrafluoroethylene (Teflon®)...*

(2.0 hours)

SLO: C11-5-22  
SLO: C11-5-23

**SUGGESTIONS FOR INSTRUCTION****Entry-Level Knowledge**

Most students will have some understanding of polymers. An assessment of students' prior knowledge is a necessary preamble to the discussion of these learning outcomes.

**Assessing Prior Knowledge**

Check for student understanding of prior knowledge and review as necessary. Prior knowledge can be reviewed and/or assessed by using any of the KWL strategies (e.g., Concept Map, Knowledge Chart, Think-Pair-Share—see *SYSTH*, Chapter 9).

**TEACHER NOTES**

One of the most important reactions of the alkenes and branched dienes is *polymerization*. When oxygen, heat, and pressure are applied to ethylene, a compound with a molecular weight of 20,000 is produced. This super-molecule is essentially a very long chain alkane. The molecule that starts the addition process is called the *monomer*, in this case, ethylene.

Polymerization usually requires the presence of a small amount of initiator. Among the most common of these initiators are the peroxides. Chemists now know that the function of the peroxide is to produce a free radical. A *free radical* is an atom or group of atoms possessing an odd (unpaired) electron (e.g.,  $\text{CH}_4 \cdot$ ). These very

**General Learning Outcome Connections**

**GLO A4:** Identify and appreciate contributions made by women and men from many societies and cultural backgrounds that have increased our understanding of the world and brought about technological innovations.

**GLO A5:** Recognize that science and technology interact with and advance one another.

**GLO D4:** Understand how stability, motion, forces, and energy transfers and transformations play a role in a wide range of natural and constructed contexts.

**GLO E1:** Describe and appreciate the similarity and diversity of forms, functions, and patterns within the natural and constructed world.

**GLO E2:** Describe and appreciate how the natural and constructed world is made up of systems and how interactions take place within and among these systems.

**SKILLS AND ATTITUDES OUTCOMES**

**C11-0-S1:** Demonstrate work habits that ensure personal safety and the safety of others, as well as consideration for the environment.

Include: knowledge and use of relevant safety precautions, Workplace Hazardous Materials Information System (WHMIS), emergency equipment

**C11-0-S9:** Draw a conclusion based on the analysis and interpretation of data.

Include: cause-and-effect relationships, alternative explanations, supporting or rejecting a hypothesis or prediction

**C11-0-C1:** Collaborate with others to achieve group goals and responsibilities.

**C11-0-C3:** Evaluate individual and group processes.

**C11-0-D1:** Identify and explore a current STSE issue.

Examples: clarify what the issue is, identify different viewpoints and/or stakeholders, research existing data/information...

**C11-0-D2:** Evaluate implications of possible alternatives or positions related to an STSE issue.

Examples: positive and negative consequences of a decision, strengths and weaknesses of a position...

**C11-0-D3:** Recognize that decisions reflect values and consider their own values and those of others when making a decision.

Examples: being in balance with nature, generating wealth, respecting personal freedom...

**C11-0-D4:** Recommend an alternative or identify a position and provide justification.

**C11-0-D5:** Propose a course of action related to an STSE issue.

**C11-0-D6:** Reflect on the process used by self or others to arrive at an STSE decision.

---

reactive, unstable free radicals add to alkenes to form larger alkane free radicals. This chain propagation occurs, forming the polymer. Eventually, two radicals combine and the process terminates.

Note that even the smallest impurity in the reaction vessel will initiate chain termination. As a result, the monomers that are used in polymerization are among the purest organic compounds produced. Many polymeric products are tough, flexible, and unreactive to most chemical reagents. Some have a waxy feel and are insoluble in most solvents. Others, with excellent thermal and electric properties, are useful insulating materials.

Chemists divide polymers into several main categories, depending on how they are prepared.

**Addition Polymers**

Addition polymers are formed by a reaction in which a monomer unit is made to be additive—that is, forming a long-chain polymer. The monomer usually contains a carbon-carbon double bond (e.g., ethylene). Polyethylene, polypropylene, polytetrafluoroethylene (Teflon<sup>®</sup>), acrylic fibre (Orlon<sup>®</sup>), and synthetic rubbers are examples of polymeric products formed in this way.

The following sequence of steps demonstrates how these polymers are formed. The sequence presented here is intended for teacher background only.

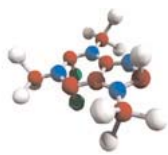
**SPECIFIC LEARNING OUTCOMES**

**C11-5-22:** Describe the process of polymerization and identify important natural and synthetic polymers.

*Examples: polyethylene, polypropylene, polystyrene, polytetrafluoroethylene (Teflon®)...*

**C11-5-23:** Describe how the products of organic chemistry have influenced quality of life.

*Examples: synthetic rubber, nylon, medicines, polytetrafluoroethylene (Teflon®)...*

(continued)

A free radical often produced from peroxide, ROOR, combines with an olefin monomer to produce a larger free radical, as shown in the sequence of steps that follow.

**Initiation:** Free radicals are produced by an initiator.

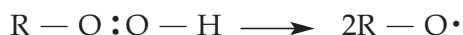

These reactive, unstable radicals react with an ethylene molecule to form another larger radical.

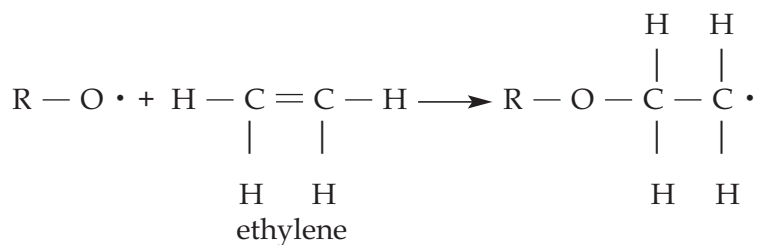

**Propagation:** Continued addition of alkene molecules produces still larger radicals.

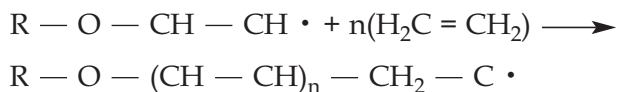

**Termination:** Two free radicals finally couple up or *disproportionate*.

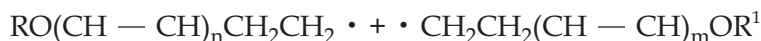

Option 1: Couple



Option 2: Disproportionate

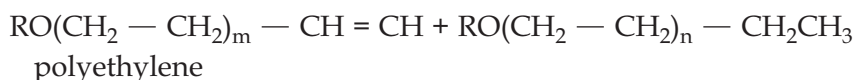

**SKILLS AND ATTITUDES OUTCOMES**

**C11-0-S1:** Demonstrate work habits that ensure personal safety and the safety of others, as well as consideration for the environment.

Include: knowledge and use of relevant safety precautions, Workplace Hazardous Materials Information System (WHMIS), emergency equipment

**C11-0-S9:** Draw a conclusion based on the analysis and interpretation of data.

Include: cause-and-effect relationships, alternative explanations, supporting or rejecting a hypothesis or prediction

**C11-0-C1:** Collaborate with others to achieve group goals and responsibilities.

**C11-0-C3:** Evaluate individual and group processes.

**C11-0-D1:** Identify and explore a current STSE issue.

Examples: clarify what the issue is, identify different viewpoints and/or stakeholders, research existing data/information...

**C11-0-D2:** Evaluate implications of possible alternatives or positions related to an STSE issue.

Examples: positive and negative consequences of a decision, strengths and weaknesses of a position...

**C11-0-D3:** Recognize that decisions reflect values and consider their own values and those of others when making a decision.

Examples: being in balance with nature, generating wealth, respecting personal freedom...

**C11-0-D4:** Recommend an alternative or identify a position and provide justification.

**C11-0-D5:** Propose a course of action related to an STSE issue.

**C11-0-D6:** Reflect on the process used by self or others to arrive at an STSE decision.

**TEACHER NOTES**

The following table illustrates various polymers that are produced when the R group is substituted for the specified groups.

Common Addition Polymers			
Structure of R	Name of Monomer	Name of Polymer	Use
-H	ethylene	polyethylene	film, conduit piping, rubber-like articles, squeeze bottles
-CH <sub>3</sub>	propylene	polypropylene	moulded and extruded plastics, film, fibres for garments and carpeting
-Cl	vinyl chloride	polyvinyl chloride	electrical insulation, film, rubber-like articles, synthetic leather, floor covering, raincoats, shower curtains
-CF <sub>2</sub> CF <sub>2</sub>	fluoroethylene	polyfluoroethylene (Teflon®)	heat- and stick-resistant coating that is resistant to high temperatures and inert to almost all solvents and other chemicals
$\begin{array}{c} \text{-O} - \text{C} - \text{CH}_3 \\    \\ \text{O} \end{array}$ vinyl acetate		polyvinyl acetate	film, fibres, moulded articles

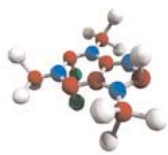

**SPECIFIC LEARNING OUTCOMES**

**C11-5-22:** Describe the process of polymerization and identify important natural and synthetic polymers.

*Examples: polyethylene, polypropylene, polystyrene, polytetrafluoroethylene (Teflon®)...*

**C11-5-23:** Describe how the products of organic chemistry have influenced quality of life.

*Examples: synthetic rubber, nylon, medicines, polytetrafluoroethylene (Teflon®)...*

(continued)

**Condensation Polymers**

Condensation polymers are formed by reactions of bi- or poly-functional (many-functional) groups, with the elimination of some small molecules such as water, ammonia, or hydrogen chloride. Familiar examples of condensation polymers are nylon, synthetic polyester fibre (Dacron®) and its synthetic film analogue (Mylar®), and polyurethane.

**Cross-Linked Polymers**

Cross-linked polymers are formed by the linking together of long chains into gigantic 3-D structures with great rigidity. Addition and condensation polymers can exist with cross-linking. Familiar examples of such compounds are phenol formaldehyde resin (Bakelite™), rubber, and fibreglass resins.

Industrialists and technologists often divide polymers into *thermoplastics* and *thermoset plastics*.

**Demonstration**

A rather unusual polymer can be found in disposable baby diapers. This granular polymer is sodium polyacrylate (Waterloc®). This solid will absorb approximately 100 times its own weight of water.

A number of “magic” tricks can be performed with the sodium polyacrylate substance and a few cardboard cups that are white on the inside.

- Place about 0.25 g of sodium polyacrylate in the bottom of one cup.
- Add a few drops of water to adhere the powder to the bottom of the cup.
- Take a glass of water and play the “shell game” with students, being careful to pour the water into each of the cups except the one with the powder.
- Shuffle the cups, and then have students guess where the water is.
- After several shuffles, pour the water into the cup with the powder in it.
- Wait a few moments and then invert the cup.

**SKILLS AND ATTITUDES OUTCOMES**

**C11-0-S1:** Demonstrate work habits that ensure personal safety and the safety of others, as well as consideration for the environment.

Include: knowledge and use of relevant safety precautions, Workplace Hazardous Materials Information System (WHMIS), emergency equipment

**C11-0-S9:** Draw a conclusion based on the analysis and interpretation of data.

Include: cause-and-effect relationships, alternative explanations, supporting or rejecting a hypothesis or prediction

**C11-0-C1:** Collaborate with others to achieve group goals and responsibilities.

**C11-0-C3:** Evaluate individual and group processes.

**C11-0-D1:** Identify and explore a current STSE issue.

Examples: clarify what the issue is, identify different viewpoints and/or stakeholders, research existing data/information...

**C11-0-D2:** Evaluate implications of possible alternatives or positions related to an STSE issue.

Examples: positive and negative consequences of a decision, strengths and weaknesses of a position...

**C11-0-D3:** Recognize that decisions reflect values and consider their own values and those of others when making a decision.

Examples: being in balance with nature, generating wealth, respecting personal freedom...

**C11-0-D4:** Recommend an alternative or identify a position and provide justification.

**C11-0-D5:** Propose a course of action related to an STSE issue.

**C11-0-D6:** Reflect on the process used by self or others to arrive at an STSE decision.

---

The sodium polyacrylate will soak up all the water and the cup will appear to be empty. (Teachers will need to practise a few times to get the appropriate amount of water and powder so that all the water is absorbed.)

**TEACHER NOTES**

Learning outcome C11-5-23 asks students to describe how the products of organic chemistry have influenced their lives. This learning outcome is best achieved by drawing on student knowledge of organic substances. After suitable class discussion and class research, ask students to write journal entries. Additional examples from medicine could be addressed, as there are plenty of examples of how organic compounds have advanced this field.

This topic was introduced by asking students how their lives would change if organic materials vanished from the classroom, the home, the hospital, the recreational world around them, and so on. Their responses could now be revisited, with the addition of further information gained from their study of the topic. Students know that organic materials have resulted in remarkable improvements to human progress. But at what expense to the environment? The discussion of this issue should lead students to the next learning outcome, which focuses specifically on STSE issues.

For additional information, see the following article:

Coggan, Jenn. "Organic Molecules of Everyday Life: 1. Citronellal." *CHEM 13 NEWS* 324 (Nov. 2004): 1-2.

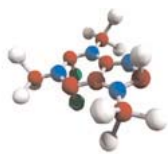

### SPECIFIC LEARNING OUTCOMES

**C11-5-22:** Describe the process of polymerization and identify important natural and synthetic polymers.

*Examples: polyethylene, polypropylene, polystyrene, polytetrafluoroethylene (Teflon®)...*

**C11-5-23:** Describe how the products of organic chemistry have influenced quality of life.

*Examples: synthetic rubber, nylon, medicines, polytetrafluoroethylene (Teflon®)...*

(continued)



### SUGGESTIONS FOR ASSESSMENT

Assessment of learning outcomes C11-5-22 and C11-5-23 could be accomplished by a number of authentic methods, some of which are described below.

The material addressed in these learning outcomes is relevant to students' lives. Students will have had some experience with almost all the polymers that have been described, whether at home, in school, or in recreational activities.

The products of organic chemistry are remarkable materials that have improved our lifestyle. But at what cost to the environment? These learning outcomes provide students with another opportunity to examine lifestyle vs. STSE issues. Students could consider questions such as the following:

- Do plastic and rubber products decay?
- What is the primary source of garbage on most seashores and lakeshores?
- What percentage of Canadians participate in recycling?
- Should there be a penalty for not recycling?
- Should there be a fee for garbage collection?

The technical information in these learning outcomes could be considered secondary to the discussion of STSE issues and decision making.

#### Research Reports

Have students conduct research and report their findings either individually or in small groups. The information collected could be presented as

- written reports
- oral presentations
- bulletin board displays
- multimedia presentations

**SKILLS AND ATTITUDES OUTCOMES**

**C11-0-S1:** Demonstrate work habits that ensure personal safety and the safety of others, as well as consideration for the environment.

Include: knowledge and use of relevant safety precautions, Workplace Hazardous Materials Information System (WHMIS), emergency equipment

**C11-0-S9:** Draw a conclusion based on the analysis and interpretation of data.

Include: cause-and-effect relationships, alternative explanations, supporting or rejecting a hypothesis or prediction

**C11-0-C1:** Collaborate with others to achieve group goals and responsibilities.

**C11-0-C3:** Evaluate individual and group processes.

**C11-0-D1:** Identify and explore a current STSE issue.

*Examples: clarify what the issue is, identify different viewpoints and/or stakeholders, research existing data/information...*

**C11-0-D2:** Evaluate implications of possible alternatives or positions related to an STSE issue.

*Examples: positive and negative consequences of a decision, strengths and weaknesses of a position...*

**C11-0-D3:** Recognize that decisions reflect values and consider their own values and those of others when making a decision.

*Examples: being in balance with nature, generating wealth, respecting personal freedom...*

**C11-0-D4:** Recommend an alternative or identify a position and provide justification.

**C11-0-D5:** Propose a course of action related to an STSE issue.

**C11-0-D6:** Reflect on the process used by self or others to arrive at an STSE decision.

---

**Visual Displays**

Students could present the material they have collected using

- posters
- pamphlets
- bulletin boards
- models

Each of these presentation styles could be assessed using an appropriate rubric created with students prior to the assignment. Samples of presentation rubrics are provided in Appendix 10 of this document.

**Journal Writing**

Encourage students to reflect on how polymers have influenced their lives.

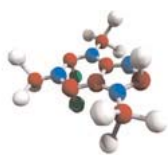

### SPECIFIC LEARNING OUTCOMES

**C11-5-22:** Describe the process of polymerization and identify important natural and synthetic polymers.

*Examples: polyethylene, polypropylene, polystyrene, polytetrafluoroethylene (Teflon®)...*

**C11-5-23:** Describe how the products of organic chemistry have influenced quality of life.

*Examples: synthetic rubber, nylon, medicines, polytetrafluoroethylene (Teflon®)...*

(continued)

---

### LEARNING RESOURCES LINKS

---



*Chemistry (Chang 1016)*

*Chemistry (Zumdahl and Zumdahl 1064)*

*Chemistry: The Central Science (Brown, et al. 456)*

*Chemistry: Concepts and Applications (Phillips, Strozak, and Wistrom 649)*

*Chemistry: The Molecular Nature of Matter and Change (Silberberg 465)*

*Glencoe Chemistry: Matter and Change (Dingrando, et al. 761)*

*Introductory Chemistry: A Foundation (Zumdahl 607)*

*McGraw-Hill Ryerson Chemistry, Combined Atlantic Edition (Mustoe, et al. 427)*

*McGraw-Hill Ryerson Chemistry 11, Ontario Edition (Mustoe, et al. 535 – silly putty, 559)*

*Nelson Chemistry 11, Ontario Edition (Jenkins, et al. 555)*

*Nelson Chemistry 12, Ontario Edition (van Kessel, et al. 98)*

*Nelson Chemistry 12, College Preparation, Ontario Edition (Davies, et al. 179 – Waterloc®, 237)*

*Prentice Hall Chemistry: Connections to Our Changing World (LeMay, et al. 827)*

**SKILLS AND ATTITUDES OUTCOMES**

**C11-0-S1:** Demonstrate work habits that ensure personal safety and the safety of others, as well as consideration for the environment.

Include: knowledge and use of relevant safety precautions, Workplace Hazardous Materials Information System (WHMIS), emergency equipment

**C11-0-S9:** Draw a conclusion based on the analysis and interpretation of data.

Include: cause-and-effect relationships, alternative explanations, supporting or rejecting a hypothesis or prediction

**C11-0-C1:** Collaborate with others to achieve group goals and responsibilities.

**C11-0-C3:** Evaluate individual and group processes.

**C11-0-D1:** Identify and explore a current STSE issue.

*Examples: clarify what the issue is, identify different viewpoints and/or stakeholders, research existing data/information...*

**C11-0-D2:** Evaluate implications of possible alternatives or positions related to an STSE issue.

*Examples: positive and negative consequences of a decision, strengths and weaknesses of a position...*

**C11-0-D3:** Recognize that decisions reflect values and consider their own values and those of others when making a decision.

*Examples: being in balance with nature, generating wealth, respecting personal freedom...*

**C11-0-D4:** Recommend an alternative or identify a position and provide justification.

**C11-0-D5:** Propose a course of action related to an STSE issue.

**C11-0-D6:** Reflect on the process used by self or others to arrive at an STSE decision.

---

**NOTES**

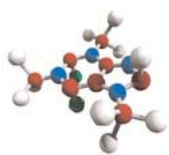
**SPECIFIC LEARNING OUTCOME**

**C11-5-24:** Use the decision-making process to investigate an issue related to organic chemistry.

*Examples: gasohol production, alternative energy sources, recycling of plastics...*

(1.5 hours)

SLO: C11-5-24

**SUGGESTIONS FOR INSTRUCTION****Entry-Level Knowledge**

A decision-making process model was introduced to the skills component of student learning outcomes in Grade 9 Science. That series of Grade 9 learning outcomes, carried forward into Grade 10 Science, has required students to investigate STSE issues using such a decision-making process model. Students should be familiar with the process; however, a review would be prudent before beginning to address this learning outcome.

**Assessing Prior Knowledge**

Check for student understanding of prior knowledge and review as necessary. Prior knowledge can be reviewed and/or assessed by using any of the KWL strategies (e.g., Concept Map, Knowledge Chart, Think-Pair-Share—see *SYSTH*, Chapter 9).

**TEACHER NOTES**

Obviously, students cannot make decisions without the necessary background information. This learning outcome is intended to encourage students to become more aware of the STSE issues in their local community. Teachers are encouraged to have students investigate a local or provincial issue that could have an impact on their community.

Previous learning outcomes in Topic 5 will have given students much of the information they require to begin the decision-making process; however, gasohol production and the recycling of plastics will require additional research. Other issues might include the production of methane and other materials from hog barns, industrial organic waste from a local industry by groundwater saturation or air contamination, and so on.

**General Learning Outcome Connections**

- GLO B1:** Describe scientific and technological developments—past and present—and appreciate their impact on individuals, societies, and the environment, both locally and globally.
- GLO B2:** Recognize that scientific and technological endeavours have been and continue to be influenced by human needs and the societal context of the time.
- GLO B3:** Identify the factors that affect health, and explain the relationships among personal habits, lifestyle choices, and human health, both individual and social.
- GLO B4:** Demonstrate knowledge of and personal consideration for a range of possible science- and technology-related interests, hobbies, and careers.
- GLO B5:** Identify and demonstrate actions that promote a sustainable environment, society, and economy, both locally and globally.

**SKILLS AND ATTITUDES OUTCOMES**

**C11-0-U1:** Use appropriate strategies and skills to develop an understanding of chemical concepts.

*Examples: analogies, concept frames, concept maps, manipulatives, particulate representations, role-plays, simulations, sort-and-predict frames, word cycles...*

**C11-0-R1:** Synthesize information obtained from a variety of sources.

Include: print and electronic sources, specialists, other resource people

**STSE Decision-Making Issues**

Teachers will decide whether to discuss one issue as a whole class or whether to have students discuss a number of different issues. Students will have differing opinions based, in part, on the source of information.

Students could present these various opinions on issues using

- debates
- posters
- courtroom arguments
- role-plays
- multimedia formats

Before students are able to use the decision-making model, they will need to organize the information collected. To make their task easier, they can use organizational forms (e.g., Knowledge Chart, 9.13, 9.25; Chain Concept Map, 11.14; Research Notes, 14.7) found in *SYSTH*.

Once students have presented their arguments, they use the decision-making process to come to a consensus. A class or grade vote could also be conducted.

For additional reference material, see the following article:

Barton, Leslie. "Plastic: Chemistry, Commerce and Culture in Canada, 1945–Present." *CHEM 13 NEWS* 324 (Nov. 2004): 15.

**Websites for Student Research**

For online information related to *alternative energy sources*, see the following websites:

Alternate Energy Resource Network: <<http://www.alternate-energy.net/>>

This website provides for a wide variety of energy alternatives as updates in industry.

Alternative Energy, Renewable Energy – Hydrogen, Solar, Biofuel, Geothermal, Hydro, and More: <[http://curtrosengren.typepad.com/alternative\\_energy/](http://curtrosengren.typepad.com/alternative_energy/)>

Developed by Curt Rosengren, this website surveys more than 20 different alternative fuel and energy sources. The site is constantly update, is very easy to navigate, and has a familiar tone.



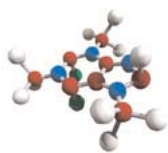

**SPECIFIC LEARNING OUTCOME**

**C11-5-24:** Use the decision-making process to investigate an issue related to organic chemistry.

*Examples: gasohol production, alternative energy sources, recycling of plastics...*

(continued)

Andy Darvill's Science Site. Energy Resources:  
<<http://www.darvill.clara.net/altenerg/>>

Darvill is a science educator in the UK. His website offers editable blackline masters and templates that are curriculum matched to the General Curriculum for Science Education (GCSE) in the UK.

Energy Alternatives Ltd.: <<http://www.energyalternatives.ca/conservation.asp>>  
This website is devoted to programs underway in Canada.

The Environment Directory:  
<[http://www.webdirectory.com/Science/Energy/Alternative\\_Energy/](http://www.webdirectory.com/Science/Energy/Alternative_Energy/)>  
A primarily American-based source of information about energy alternatives, this website can provide a useful contrast to the previous Canadian link.

Topix.net. Alternative Energy News: <<http://www.topix.net/tech/alt-energy>>  
This "clearinghouse" type of website provides many links to other, more specific, sources of information from the field of alternative energy research and development.

For information on *ethanol-blended fuels*, see the following websites:

Manitoba Energy, Science and Technology. Energy Development Initiative. Gasohol Incentives: <<http://www.gov.mb.ca/est/energy/ethanol/ethincentives.html>>

---. ---. Ethanol-Blended Fuels:  
<<http://www.gov.mb.ca/est/energy/initiatives/ethanolfuels.html>>

Renewable Fuels Association: <<http://www.ethanolrfa.org/>>

For information on *recycling*, particularly plastics, see the following websites:

The American Plastics Council. Plastic Recycling Resources:  
<[http://www.plasticsresource.com/s\\_plasticsresource/doc.asp?TRACKID=&CID=40&DID=420](http://www.plasticsresource.com/s_plasticsresource/doc.asp?TRACKID=&CID=40&DID=420)>

Canadian Plastics Industry Association. Environment and Plastics Industry Council (EPIC): <<http://www.cpia.ca/epic/media/news.php?ID=1332>>

---. ---. Teacher Resource Site: <<http://www.plastics.ca/teachers/>>

**SKILLS AND ATTITUDES OUTCOMES**

**C11-0-U1** Use appropriate strategies and skills to develop an understanding of chemical concepts.

*Examples: analogies, concept frames, concept maps, manipulatives, particulate representations, role-plays, simulations, sort-and-predict frames, word cycles...*

**C11-0-R1:** Synthesize information obtained from a variety of sources.

Include: print and electronic sources, specialists, other resource people

---

New York State Department of Environmental Conservation. Recycling Plastics Is as Easy as...:

<<http://www.dec.state.ny.us/website/dshm/redrecy/plastic.htm>>

Obvious Implementations Corporation/Obviously Enterprises. The Internet Consumer Recycling Guide: <<http://www.obviously.com/recycle/>>

Ohio Department of Natural Resources. Division of Recycling and Litter Prevention. Recycling Plastic: <<http://www.dnr.state.oh.us/recycling/plastics/>>

U.S. Environmental Protection Agency. Recycle City:

<<http://www.epa.gov/recyclecity/>>

Waste Online. Plastic Recycling Information Sheet:

<<http://www.wasteonline.org.uk/resources/InformationSheets/Plastics.htm>>

**SUGGESTIONS FOR ASSESSMENT****Rubrics/Checklists**

See Appendix 10 for a variety of rubrics and checklists that can be used for self-assessment, peer assessment, and teacher assessment.

**Journal Writing**

Ask students to write a journal entry summarizing their opinion of the decision of the majority vs. the minority regarding the STSE issues discussed. What, if any, compromises were necessary to resolve the issues?

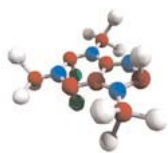

### SPECIFIC LEARNING OUTCOME

**C11-5-24:** Use the decision-making process to investigate an issue related to organic chemistry.

*Examples: gasohol production, alternative energy sources, recycling of plastics...*

(continued)

---

## LEARNING RESOURCES LINKS

---



### Gasohol

*Chemistry* (Zumdahl and Zumdahl 277, 1059)

*Chemistry: The Molecular Nature of Matter and Change* (Silberberg 243)

*Introductory Chemistry: A Foundation* (Zumdahl 601)

*Prentice Hall Chemistry: Connections to Our Changing World* (LeMay, et al. 296, 843)

### Alternative Energy Sources and Climate

*Glencoe Chemistry: Matter and Change* (Dingrando, et al. 730, 860)

### Recycling and Plastics

*Chemistry: Concepts and Applications* (Phillips, Strozak, and Wistrom 659, 661)

*Glencoe Chemistry: Matter and Change* (Dingrando, et al. 764)

*Prentice Hall Chemistry: Connections to Our Changing World* (LeMay, et al. 33, 55, 829)

**SKILLS AND ATTITUDES OUTCOMES**

**C11-0-U1:** Use appropriate strategies and skills to develop an understanding of chemical concepts.

*Examples: analogies, concept frames, concept maps, manipulatives, particulate representations, role-plays, simulations, sort-and-predict frames, word cycles...*

**C11-0-R1:** Synthesize information obtained from a variety of sources.

Include: print and electronic sources, specialists, other resource people

---

**NOTES**



# APPENDICES

---

Topic 1: Physical Properties of Matter Appendices

Topic 2: Gases and the Atmosphere Appendices

Topic 3: Chemical Reactions Appendices

Topic 4: Solutions Appendices

Topic 5: Organic Chemistry Appendices

General Appendices



# TOPIC 1:

# PHYSICAL PROPERTIES OF MATTER

## APPENDICES

---

Appendix 1.1: Demonstrating Diffusion on an Overhead Projector	3
Appendix 1.2: A “Real” Water Fountain	5
Appendix 1.3: Popping the Kernel: Modelling the States of Matter	6
Appendix 1.4: Kinetic Energy Distribution	10
Appendix 1.5: Bond Types and Conductivity	11
Appendix 1.6: Chemistry Article Review Form	15
Appendix 1.7: Making Fingerprints Visible	16
Appendix 1.8: Probeware Investigation: Determining Melting Points	17
Appendix 1.9: Vapour Pressure with Pop	22
Appendix 1.10: Measuring the Vapour Pressure of a Liquid	24
Appendix 1.11: Forces between Particles	27
Appendix 1.12: Freezing by Boiling	31
Appendix 1.13: Gas Laws: Temperature and Pressure Changes	32
Appendix 1.14: Chemistry Is Super: “Bingo” Review Game	36

**Note:**

Due to copyright considerations, Appendix 1.3: Popping the Kernel: Modelling the States of Matter is available only in the print document.





## Appendix 1.1: Demonstrating Diffusion on an Overhead Projector

### Introduction

A small amount of a liquid is placed in one compartment of a partitioned petri dish and two solids are sprinkled into two adjacent compartments. After a minute or so, some of the liquid has wet one of the solids and one of the solids has coloured the liquid.

### Chemical Concepts

- vapour pressure
- sublimation
- Raoult's Law
- diffusion
- equilibrium

### Materials

- four-quadrant glass petri dish with cover
- overhead projector and screen
- acetone
- paradichlorobenzene (or other relatively high vapour pressure solid)
- iodine

### Procedure

Sprinkle a few small crystals of paradichlorobenzene into one compartment of a four-quadrant petri dish and sprinkle a few crystals of iodine into the opposite compartment. Place the dish on an overhead projector stage. Add 1 or 2 mL of acetone to one of the remaining wells of the petri dish and cover it.

Have students observe the petri dish on the overhead projector. After a minute or so, small droplets of liquid can be observed surrounding the paradichlorobenzene crystals but not anywhere else in the dish. After a few minutes, the paradichlorobenzene crystals are completely dissolved in acetone and only droplets of solution appear. Some iodine has migrated into the edge of the acetone and is itself wet with acetone.

---

**Demonstrating Diffusion on an Overhead Projector:** Copyright © by Walter Rohr, Eastchester High School, Eastchester, NY. Adapted by permission of the author. All rights reserved.

**Appendix 1.1: Demonstrating Diffusion on an Overhead Projector** *(continued)*

---

**Discussion**

When the dish is sealed, migrating acetone molecules eventually collide with the surface of the paradichlorobenzene, forming bonds and, consequently, a solution. Since the vapour pressure of the paradichlorobenzene is lower than that of pure acetone (2 torr vs. 230 torr at 25°C), the resulting solution will have a lower vapour pressure than the pure acetone (Raoult's Law), preventing equilibrium from being achieved. As a result, higher vapour pressure acetone molecules continue to be forced into the lower vapour pressure solution in an attempt to produce equilibrium. If the demonstration is allowed to continue, the process will proceed until all the acetone has transferred into the paradichlorobenzene and iodine compartments. Eventually, the iodine can be observed discolouring the acetone at the edge nearest its compartment and itself being wet with the acetone.

## Appendix 1.2: A “Real” Water Fountain

### Introduction

A small quantity of water is heated in a 1 L flask to replace all the air. When the flask is filled with water vapour or steam, the heating is stopped. Steam condenses and the pressure inside the flask drops. Cold water from a beaker flows rapidly into the evacuated flask.

### Materials

- 7 mm glass tubing (bent)
- one-hole #8 rubber stopper
- Florence flask (1 L)
- beaker (1 L)

### Procedure

1. Fill the beaker with water.
2. Place 20 mL of water in the flask. Stopper the flask and use the tubing to connect the flask to the water-filled beaker.
3. Heat the flask. Gas from the warming flask will begin to flow into the beaker. Bubbles indicate the air being displaced from the flask.
4. Continue heating until the bubbling in the beaker ceases. This will happen by the time the water in the flask is at a full boil. Bubbles are no longer seen in the beaker if water vapour leaving the flask and entering the beaker is condensing.
5. Remove the source of heat from the flask. As the flask starts to cool, the water from the beaker will begin to flow from the beaker through the tube and into the flask. It can be spectacular!

### Safety Precaution

By using water, this demonstration is relatively safe, provided the tubing is carefully shaped and free of obstructions.

### Discussion

Steam from the heating water drives out the air from the flask. As the flask cools, the steam condenses and pressure inside the flask drops rapidly. Water from the beaker is then pushed into the flask by atmospheric pressure. Observe not only the powerful jet of water from the glass tube, but also the resurgence of boiling for any water remaining in the flask as the inside pressure is lowered. This boiling occurs almost simultaneously with the rushing of water into the flask.

---

**A “Real” Water Fountain:** Copyright © by Penney Sconzo, Westminster High School, Atlanta, GA. Adapted by permission of the author. All rights reserved.

## Appendix 1.4: Kinetic Energy Distribution

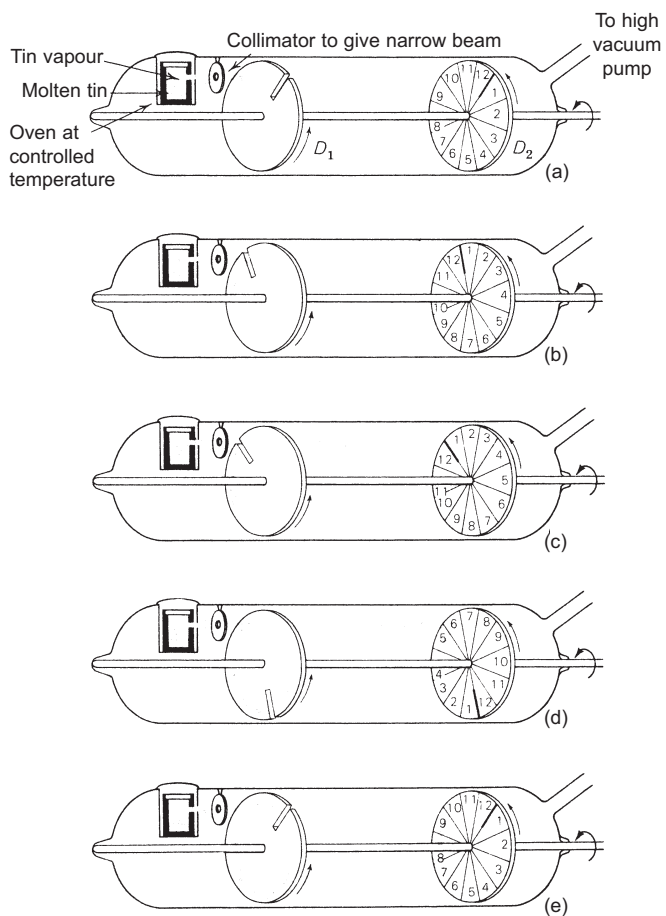

Rotating disk used to measure atomic or molecular velocities.

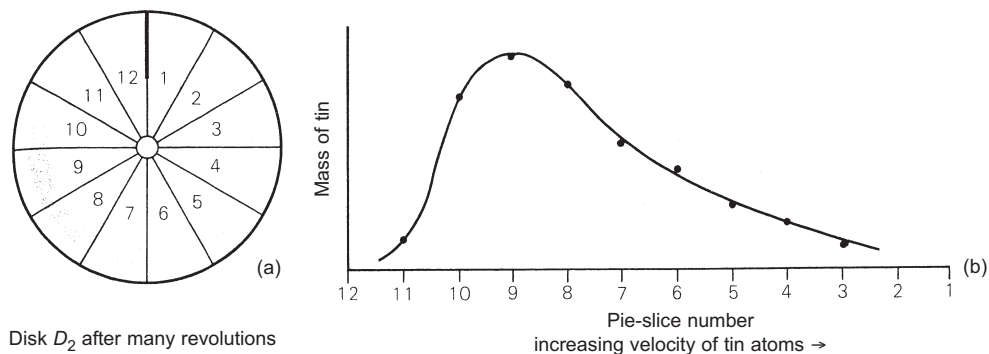

The relative distribution of atomic or molecular velocities obtained from the rotating disk.

**Kinetic Energy Distribution Figures:** From *Chemistry: Experimental Foundations* Robert W. Parry, Phyllis M. Dietz, Robert L. Tellefsen & Luke E. Steiner © 1975 by Prentice Hall. Used by permission of Pearson Education, Inc.

## Appendix 1.5: Bond Types and Conductivity

### Question

What types of liquids or solutions conduct electricity and which ones do not?

### Prediction

Can a conductivity test determine the type of bond present within a substance?

### Materials

- computer system and conductivity sensor
- distilled water
- tap water
- ethyl alcohol,  $C_2H_5OH$
- 0.05 M concentration solutions of sugar ( $C_{12}H_{22}O_{11}$ ), table salt (NaCl), NaI, KCl, and KI
- 8 small beakers (100 mL)

### Safety Precautions

- Wear a lab apron and safety goggles.
- Ethyl alcohol is flammable. Keep away from flames.
- Table salt, NaCl, may cause eye irritation and pain.
- NaI is harmful if swallowed.
- KI is harmful if swallowed.
- Use caution with all solutions, as some are caustic, or poisonous, or will stain clothing.

### Procedure

1. Prepare a recording table as follows:

Data Table				
Trial #	Liquid or Solution	Predicted Type of Bond	Conductivity ( $\mu S$ )	Type of Bond
1	Sugar			
2	NaCl			
3	NaI			
4	KCl			
5	KI			
6	Distilled water			
7	Tap water			
8	Ethyl alcohol			

**Appendix 1.5: Bond Types and Conductivity** (*continued*)

---

- Predict the type of bond that each of the substances will be and record this in the appropriate column of the table.
- Place approximately 30 mL of sugar solution into a beaker. Label the beaker "sugar."
- Repeat step 3, using NaCl, NaI, KCl, and KI solutions.
- Prepare three beakers containing 30 mL of distilled water, tap water, and ethyl alcohol. Label them appropriately.
- Set up the computer system with the conductivity sensor.
- Calibrate the conductivity sensor.
- Display the conductivity tester with a digits display and/or meter display.
- Start the probeware data collection.
- Submerge the conductivity sensor end completely into the beaker of sugar solution.
- Once the reading has stabilized, record the measure of conductivity into the recording table.
- Remove the sensor from the beaker of sugar and completely rinse the sensor with distilled water. Then dry with tissue.
- Repeat steps 10 to 12 with each of the different liquids and solutions.
- Stop the data recording.
- Discard the solutions as directed by your teacher. Do not pour anything down the drain.

**Questions****Analysis**

- Which solutions were strong electrolytes and which solutions were weak electrolytes or non-electrolytes?
- Explain any differences in your results for distilled water and tap water.

**Conclusions**

- In general, what bond types conduct electricity?
- In general, what bond types do not conduct electricity?

**Appendix 1.5: Bond Types and Conductivity** (*continued*)

---

**Extensions**

5. How will the conductivity change if the amount of solute (one which has been shown to conduct electricity) dissolved into the solvent is increased to the point of saturation?
6. Solutions of ionic substance conduct electricity because a flow of electricity is caused by the charged ions in the solution. *Cations* (positive ions) move toward the negative electrode or cathode. *Anions* (negative ions) move toward the positive electrode or anode. This movement of ions toward the oppositely charged electrode in the solution causes the flow of electric charge. Why do cations move toward the cathode and not toward the anode?
7. Collect tap water from your home and test it for conductivity. How does it compare to the tap water from school or from another student's home?



## Appendix 1.5: Bond Types and Conductivity (Teacher Notes)

### Sample Data: Answer Key

#### Observations

Data Table				
Trial #	Liquid or Solution	Predicted Type of Bond	Conductivity ( $\mu\text{S}$ )	Type of Bond
1	Sugar		0.0	Covalent
2	NaCl		111.1	Ionic
3	NaI		112.8	Ionic
4	KCl		133.4	Ionic
5	KI		115.9	Ionic
6	Distilled water		0.0	Covalent
7	Tap water		42.3	Ionic
8	Ethyl alcohol		0.0	Covalent

#### Analysis

- Strong electrolytes: NaCl, NaI, KCl, and KI.

Weak electrolytes: tap water (depending on the water source—some water sources will be greater conductors of electricity than others).

Non-electrolytes: distilled water, sugar, and ethyl alcohol.

- Tap water varies in terms of number of free ions.  $\text{Fe}^{3+}$ ,  $\text{Ca}^{2+}$ ,  $\text{CO}_3^{2-}$ ,  $\text{Cl}^-$ , and traces of many others are often found in tap water. Distilled water usually has most of these ions removed.

#### Conclusions

- Ionic bonds conduct electricity.
- Covalent bonds do not conduct electricity.

#### Extensions

- Generally, the solution will conduct greater electricity as more solute is dissolved. At some point, the conduction will maximize and added dissolved solute will actually reduce the conductivity of the solution. Two different concentrations with the same conductivity measurement will result.
- Opposites attract and positive ions will be attracted by the negative electrode, while negative ions will be attracted by the positive electrode.
- Results will vary.

**Appendix 1.6: Chemistry Article Review Form**

Theme: \_\_\_\_\_

Find a newspaper/magazine/Internet article that fits a topic related to the chemistry theme above. Its minimum size must be 200 words.

Student Name: \_\_\_\_\_ Course: \_\_\_\_\_

Author(s) of Article: \_\_\_\_\_

Article Source/Website: \_\_\_\_\_

Article Title: " \_\_\_\_\_ "

Date of Article: \_\_\_\_\_ Page(s): \_\_\_\_\_

A. Attach the article (or photocopy) to the back of this page.

B. Highlight (or underline) the main idea found in the article. Briefly state the main idea in your own words: \_\_\_\_\_  
\_\_\_\_\_

C. List two important facts the author uses to support the main idea (full sentences):

1. \_\_\_\_\_

2. \_\_\_\_\_

D. Identify three science-related terms found in the article and write definitions (in context) for each:

1. \_\_\_\_\_ : \_\_\_\_\_  
\_\_\_\_\_2. \_\_\_\_\_ : \_\_\_\_\_  
\_\_\_\_\_3. \_\_\_\_\_ : \_\_\_\_\_  
\_\_\_\_\_E. Describe what you found most interesting about your article: \_\_\_\_\_  
\_\_\_\_\_  
\_\_\_\_\_

Remember, you are being assessed on all the above components of the review.

## Appendix 1.7: Making Fingerprints Visible

---

### Introduction

When we touch things, the ridges of our fingertips often leave impressions. These impressions are called fingerprints. We are not often aware that we leave fingerprints, and sometimes objects must be treated chemically to make these prints visible. In this activity, we will make a fingerprint on paper and then treat the paper to make the print visible. You might compare your fingerprints with those of other students. You will find that no two are alike.

### Materials

- unlined white index cards or white paper
- iodine (I<sub>2</sub>) crystals
- Erlenmeyer flask (250 or 125 mL)
- burner
- tongs
- scissors

### Procedure

1. Cut narrow strips of paper small enough to be held in the neck of the Erlenmeyer flask.
2. Press one of your fingers firmly on one end of a paper strip.
3. Place some iodine crystals (an amount about the size of a pencil eraser) in the flask. Heat gently with a burner or on a hot plate until the iodine begins to vaporize. **Caution:** Be careful. Do not breathe iodine vapour. Perform this in the fume hood.
4. Place the paper strip into the flask to expose it to the iodine vapour. Hold until changes to the paper are observed.

### Questions

1. The melting point of iodine is 113.5°C. What happens if iodine is heated above this temperature? (Ask the teacher for a demonstration.)
2. Compare the volume of iodine vapour to the volume of the same mass of solid iodine.
3. What changes of state took place in this experiment? Identify and describe each. *Example: "Freezing—the liquid water froze solid."*
4. What movie demonstrated a similar process? (Hint: Eddie Murphy)

## Appendix 1.8: Probeware Investigation: Determining Melting Points

### Question

How can the melting points of various organic compounds be found?

### Prediction

The melting point of a compound is the temperature at which the solid and liquid phases are in equilibrium. This is a physical property often used to identify compounds or to check the purity of the compound.

Predict what the melting points of different organic substances will be.

### Materials

- computer system and interface
- temperature sensor
- melting point capillary tubes (closed at one end)
- filter papers
- 1-gram samples from the following list: vanillin, naphthalene, resorcinol, acetanilide, benzoic acid, 2-naphthol, urea, maleic acid, cholesterol, citric acid, salicylic acid
- clean cloth
- Thiele tube filled with mineral oil to a level no more than 2 cm above the upper inlet of the sidearm
- two-holed stopper to fit the top of the Thiele tube
- 3 cm (3 mm outside diameter) rubber tubing
- scissors
- Bunsen burner

### Safety Precautions

- Be sure the room is well ventilated.
- This experiment must be done carefully to avoid burns and broken glass.

### Procedure

1. Set up the computer system with the temperature sensor set to record at a rate of once per second.
2. Represent the sensor with a graph (temperature vs. time) and digits display.
3. Obtain a melting point capillary tube and a sample of the known compound.
4. To load the melting point capillary tube, place a small amount of the compound on clean filter paper. Push the open end of the melting point capillary tube into the middle of the pile of compound. Some solid should be trapped in the tube—use the smallest amount of material that can be seen.
5. Turn the melting point capillary tube over, closed end down. Use a clean cloth to remove any compound sticking to the outside.

**Appendix 1.8: Probeware Investigation: Determining Melting Points** *(continued)*

---

6. Keeping the melting point capillary tube vertical, drop it from a height of 2 cm perpendicularly onto a solid surface repeatedly. The compound is packed when the entire compound has reached the bottom of the melting point capillary tube.
7. Clamp the Thiele tube just under the mouth with the utility clamp that is attached midway to the support stand.
8. Fit the temperature probe through the two-holed stopper, so that when placed into the Thiele tube, the tip will be immersed adjacent to the upper inlet of the sidearm.
9. Using scissors, cut a 2 mm section of the rubber tubing, to be used as a small rubber band.
10. Place the closed end of the loaded melting point capillary tube next to the end of the temperature probe. Place the rubber band around the temperature probe and melting point capillary tube so that it is 1 cm from the top of the melting point capillary tube.
11. Keeping the temperature probe vertical, place the stopper apparatus into the Thiele tube.
12. Start the temperature sensor to monitor the temperature.
13. Heat the mineral oil with a moderate burner flame, directing it at the curved side of the Thiele tube.
14. Allow the temperature to rise rapidly to within 15°C to 20°C below the expected melting point of the compound.
15. Adjust the flame size so the temperature rises no more than 2°C to 3°C per minute just before, during, and just after the period in which the compound melts.
16. Record the range of temperature from the first visible evidence of liquid (the sample appears moist, or a tiny drop of liquid is observed) to the complete liquefaction of the sample.
17. After the sample has melted, lift the thermometer and attached sample tube carefully (it may be hot) until they are just out of the oil. Wait for the thermometer to cool to about room temperature before you remove it entirely from the tube.
18. Remove the melting point capillary tube and wipe off some of the oil from the thermometer.
19. Reload a new melting point capillary tube (never re-melt melted samples), and repeat steps 3 to 18 for each of the rest of the samples provided.
20. Stop recording the data.
21. Clean up and discard the materials as directed by your teacher. Do not pour anything down the drain.

**Appendix 1.8: Probeware Investigation: Determining Melting Points** (*continued*)

---

**Questions****Analysis and Conclusions**

1. Why does the sample in the melting point capillary tube have to be packed tightly?
2. Why should the filled portion of the capillary tube be placed immediately adjacent to the mercury bulb of the thermometer?
3. What were the melting temperatures of the compounds analyzed?

**Applications**

4. List two ways in which the melting point of a solid organic compound could be useful to organic chemists.
5. What is the effect of a small amount of impurity on the melting point of an organic compound?
6. The freezing point of a substance has the same numerical value as its melting point, yet melting points are routinely measured but freezing points are not. Why?
7. Why is this method not used for finding the melting points of inorganic compounds?

## Appendix 1.8: Probeware Investigation: Determining Melting Points (Teacher Notes)

---

### Notes

1. If necessary, use a spatula to grind the compound into a fine powder so that it may enter the melting point capillary tube.  
Pack the compound into the melting point capillary tubes. If left loose, the compound will heat unevenly.  
A dropping tube may be used to assist in packing the compound into the melting point capillary tubes.
2. With the Thiele tube, hot oil is used to transfer heat evenly to your sample in the melting point capillary tube. Oil in the sidearm is heated and it expands to become less dense. The hot oil goes up the sidearm, warming the sample and the thermometer as it touches them. The oil cools and becomes denser and it falls to the bottom of the tube where it is heated again. This cycle goes on automatically as you do the melting point test in the Thiele tube.  
Water must not get into the Thiele tube. If it happens, the water can boil and throw hot oil out at you.
3. Take care that the rubber band securing the melting point capillary tube to the temperature probe remains above the mineral oil throughout the experiment.
4. Never re-melt any samples. They may undergo chemical changes such as oxidation, rearrangement, and decomposition.
5. The melting point is defined as the temperature range over which a small amount of solid in a thin walled capillary tube first visibly softens (first drop of liquid) and then completely liquefies. Thus, the melting point is actually a melting range.
6. Melting points recorded in chemical journals are capillary melting points unless otherwise stated.

### Answer Key

#### Analysis and Conclusions

1. So that the melting can be observed within in the same place where the temperature is being monitored.
2. This allows the melting temperature of the sample to be monitored with accuracy.

---

**Appendix 1.8: Probeware Investigation: Determining Melting Points  
(Teacher Notes) (continued)**

---

3. Answers will vary. Suggested results:

Compound	Melting Point (°C)
vanillin	77-82
naphthalene	79-80
resorcinol	109-110
acetanilide	113-114
benzoic acid	121-122
2-naphthol	121-122
urea	132-133
maleic acid	136-137
cholesterol	148-150
citric acid	150-153
salicylic acid	156-158

**Applications**

4. a) Determination of purity. Impurities generally have two effects: they lower the melting point from what it would be for the pure compound and they cause the melting point range to broaden.  
b) The melting point of an unknown sample can also be found by having students repeat the experiment and comparing their findings to a list of known melting points of different organic compounds. Many texts contain tables of melting points and lists of compounds that may have a particular melting point. One of them may be the unknown. If nothing else, you know the melting point of your unknown.
5. The melting point temperature range will be wider than 2°C.
6. In practice, freezing points are rarely measured because they are more difficult to determine than melting points. One reason for this is that solidification may not occur at the correct temperature due to the phenomenon of supercooling.
7. Inorganic compounds have extremely high melting points.



## Appendix 1.9: Vapour Pressure with Pop

---

### Introduction

A small volume of a liquid is added into a container and sealed. The container is then rolled to coat its sides with the liquid. After a minute or so, the cap pops off the container with report.

Chemical concepts: vapour pressure, volatility, Dalton's Law of partial pressures, and atmospheric pressure.

### Materials

- petroleum ether or pentane
- tennis-ball can (or a vial or a film canister)
- thin-stem polyethylene transfer pipette

### Safety Precautions

Petroleum ether and pentane form explosive mixtures with air. Do not perform this demonstration near a flame or near operating machinery. Aim the container into the air to avoid hitting anyone with the flying lid.

### Procedure

1. Add 3 to 4 mL of petroleum ether or pentane to a clean, dry tennis-ball can with a thin-stem pipette or by pouring a pre-measured amount from a beaker. Quickly seal the can with its lid and roll to coat the sides with the hydrocarbon. It is helpful if you warm the can with your hands as you roll it to increase the vapour pressure of the liquid. Have a student feel the sides of the can to observe the lower temperature, implying evaporation. After a minute or so, the lid will pop off the can with a loud noise.
2. This demonstration can also be performed using a vial or a film canister and pentane. Add enough liquid to cover the bottom of a large vial and quickly seal it by pressing on its lid. Swirl the container to coat the sides with the liquid, simultaneously warming it with your hands. If the lid does not pop in a minute or so, start the lid by carefully lifting it with your thumb. The experiment can often be repeated by simply pressing the lid back on the vial or adding more pentane.

### Notes

- The tennis-ball cans with the tightest fitting lids work best in this demonstration.
- The larger the vial is the better, since large vials have a proportionally small surface area in contact with the lid.
- Only those vials or film canisters with press-fit lids (the lids fit totally inside the vials) seem to work with any consistency.

---

**Vapour Pressure with Pop:** Copyright © by Walter Rohr, Eastchester High School, Eastchester, NY.  
Adapted by permission of the author. All rights reserved.

---

**Appendix 1.9: Vapour Pressure with Pop (continued)**

---

**Discussion**

Pentane and petroleum ether (a mixture of pentane, and various isomers of hexane) have vapour pressures in excess of 400 torr at room temperature (consult the Material Safety Data Sheet for the exact vapour pressure of your petroleum ether). Since the inside diameter of a tennis-ball can is roughly 7 cm, which gives an area of  $38 \text{ cm}^2$  ( $6 \text{ in.}^2$ ), the net force exerted would be 46 pounds ( $6 \text{ in.}^2 \times 14.7 \text{ lb./in.}^2 \times 400/760 \text{ atm}$ ), more than enough to blow off the lid. Pentane, with an even higher vapour pressure of 512 torr, would exert a net force of roughly 59 pounds under the same conditions ( $6 \text{ in.}^2 \times 14.7 \text{ lb./in.}^2 \times 512/760 \text{ atm}$ ).

The inside diameter of a film canister used in the demonstration is 3.0 cm. A 3.0 cm diameter cap has an area of  $7.0 \text{ cm}^2$  ( $1.1 \text{ in.}^2$ ) and, when using pentane, would experience a force of about 11 pounds ( $1.1 \text{ in.}^2 \times 14.7 \text{ lb./in.}^2 \times 512/760 \text{ atm}$ ). Again, this would be more than enough force to pop the lid.

This demonstration can also be used to illustrate Dalton's Law of partial pressures. What is the pressure inside the container before the cap flies off? Using Dalton's Law, the total pressure inside the container is the sum of the individual partial pressures.

$$\begin{aligned}\text{Pressure inside the container} &= P_{\text{atm}} + P_{\text{vapour}} = 760 \text{ torr} + 400 \text{ torr} \\ &\approx 1160 \text{ torr or } 1.5 \text{ atm}\end{aligned}$$

$$\begin{aligned}\text{Force exerted on the inside of the lid} &= 1.5 \text{ atm} \times 14.7 \text{ lb./in.}^2 \times 6 \text{ in.}^2 \\ &= 135 \text{ lbs.}\end{aligned}$$

What is the net force pushing the lid off the container?

$$\begin{aligned}\text{Net force} &= \text{Force inside the container} - \text{Force of the atmosphere} \\ &= 1.5 \text{ atm} - 1.0 \text{ atm} = 0.5 \text{ atm} \\ &= 0.5 \text{ atm} \times 14.7 \text{ lb./in.}^2 \times 6 \text{ in.}^2 = 46 \text{ lbs.}\end{aligned}$$

**Note:** The same calculations could be done with kPa but would not be as meaningful to most students.

**Disposal**

Pour the excess petroleum ether or pentane into a shallow pan or glass dish and allow it to evaporate in a working fume hood.

## Appendix 1.10: Measuring the Vapour Pressure of a Liquid (Student Experiment)

### Problem

To measure the vapour pressure of a liquid.

### Materials

- samples of several liquids
- about 1 m flexible plastic tubing to fit glass tubing
- about 1 m glass tubing
- suction flask (250 mL)
- rubber stopper to fit suction flask
- 2 ring stands
- 1 ring clamp
- 3 clamps
- metre stick
- transparent tape
- graduated cylinder
- thermometer

### Procedure

1. Set up the apparatus as shown in the diagram to the right. **Note:** Fill the plastic tubing with water before attaching it to the suction flask and glass tubing.
2. Adjust the apparatus so that the level of water in the two arms is equal, and the level can be read on the metre stick. Read and record the water level.
3. Measure and record the temperature of the room.
4. Select one liquid. Add \_\_\_ mL of your liquid. Pour the liquid into the suction flask and quickly stopper the flask with the rubber stopper.
5. Describe what happens to the water in the tubing. Wait until no further change is apparent.
6. Adjust the apparatus so that the level of water in the two arms of the tubing can be read. Read and record the water level in *both* arms of the tubing.
7. What is the vapour pressure of the liquid? How do you know?
8. Either cool the outside of the suction flask by placing an ice cube on it, or warm the flask with your hands. Record your observations.

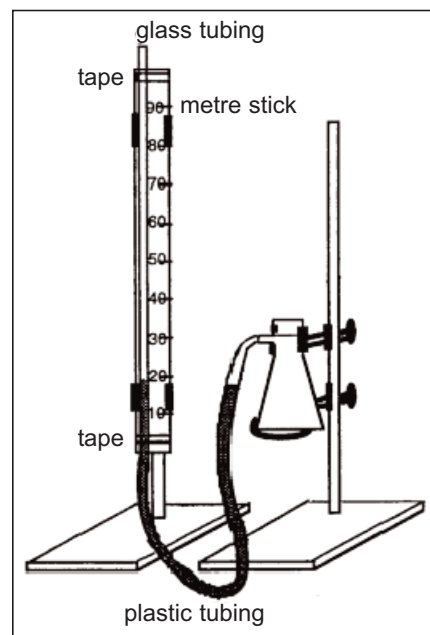

**Appendix 1.10: Measuring the Vapour Pressure of a Liquid**  
**(Student Experiment) *(continued)***

---

**Questions**

1. Is the vapour pressure of the liquid the same at all temperatures? How do you know? How could you find out? Can you devise a method to measure the vapour pressure of your liquid at 0°C?
2. Convert the vapour pressure you measured to vapour pressure in the following units: mmHg, torr, atmosphere, and pascal.
3. Why do you have to put a stopper on the flask?

## Appendix 1.10: Measuring the Vapour Pressure of a Liquid (Discussion—Teacher Notes)

The experiment described in Appendix 1.10 is simple and quick. For best results, give several students different amounts of the same liquid (e.g., 2 mL, 5 mL, 10 mL cyclohexane). Students should be able to deduce the following from the results:

- Time is required for vapour equilibrium to be established – the water level changes over two to five minutes. Students may not use the term “equilibrium” in their explanations; instead, they may say that some time is required for the apparatus to stabilize as the liquid vaporizes and mixes with the air in the flask.
- The vapour pressure is independent of the amount of liquid, provided some liquid is present in the container.
- Vapour pressure can be measured only in a closed system.
- Vapour pressure is different for different liquids.
- Vapour pressure varies with temperature.

Encourage students to set up their own apparatus. A #6 rubber stopper fits a 250 mL suction flask. Five-sixteenths (5/16th) inch Nalgene® or Tygon® tubing fits the sidearm of a 250-mL suction flask. Filling the tubing with water may be tricky – fill the tubing by slowly adding water and allowing the air bubbles to escape.

Some results obtained with this apparatus are:

Liquid	Temperature	“Height” in Glass	“Height” in Plastic	Vapour Pressure
acetone	22°C	62.2 cm	6.7 cm	55.5 cm water (40.8 mmHg)
ethanol (95%)	20°C	26.4 cm	4.8 cm	21.6 cm water (15.9 mmHg)
cyclohexane	20°C	39.5 cm	3.7 cm	35.8 cm water (26.3 mmHg)

### Notes:

- Both acetone and ethanol are highly soluble in water. Their vapours also dissolve, and the results tend to be low. Best results will be obtained with non-polar liquids such as cyclohexane or hexane.
- This experiment could easily be extended to measure the time to reach equilibrium, and so the rate of vaporization.
- Alternative methods may be used.
- An experiment to measure the vapour pressure of water as a function of temperature is also described in the following article:

Levinson, Gerald S. “A Simple Experiment for Determining Vapour Pressure and Enthalpy of Vaporization of Water.” *Journal of Chemical Education* 59.4 (April 1982): 337–338.

## Appendix 1.11: Forces between Particles

---

### Question

What is the relationship between the pressure and the temperature of a gas?

### Prediction

Once the vapour pressure curve of one liquid is determined, predict how it will compare to a different liquid's vapour pressure curve.

### Materials

- computer system and temperature pressure sensor
- two 250 mL pressure flasks (thick-walled)
- two-holed stopper (to fit into the flasks)
- glass eyedropper stem (glass part only)
- 800 mL beaker with hot water bath (80°C)
- hot plate
- 10 mL acetone,  $\text{CH}_3\text{COCH}_3$
- 10 mL ethyl alcohol,  $\text{C}_2\text{H}_5\text{OH}$

### Safety Precautions

- Wear a lab apron and safety goggles.
- Acetone is extremely flammable. Vapour is an irritant to eyes, skin, and lungs.
- Ethyl alcohol is highly flammable. High concentrations of vapour and concentrated solutions are dangerous.
- This experiment must be done carefully to avoid burns and broken glass.

### Procedure

1. Set up the computer system with the temperature sensor and pressure sensor.
2. Display the pressure sensor with a graph and the temperature sensor on the same graph so that pressure is recorded along the vertical axis and temperature is recorded along the horizontal axis.
3. Insert the thermometer sensor into one of the two holes of the stopper (from the wide end out through the narrow end of the stopper) so that its tip will be within the centre of either flask when it is stoppered.
4. Insert the wide end of the glass eyedropper stem into the other outer hole of the wide end of the stopper.
5. Connect the pressure sensor tube to the narrow tip of the glass eyedropper.
6. Prepare the beaker with the hot water bath  $\frac{3}{4}$  full at 80°C.
7. Place 10 mL of acetone into a 250 mL flask.
8. Place the flask into the hot water bath for five minutes.
9. Begin monitoring the temperature and pressure.

**Appendix 1.11: Forces between Particles** (*continued*)

---

10. Insert the two-holed stopper with pressure and temperature sensor into the flask.
11. Remove the flask from the hot water bath.
12. Once the temperature and pressure stabilize, stop monitoring the data and start recording the data for Run #1.
13. Stop the data recording once the graph reaches 30°C.
14. Clean up the materials as directed by the teacher.
15. Repeat steps 7 to 14, using a clean flask and ethyl alcohol instead of acetone.

**Questions****Analysis**

1. What experimental factors were kept constant during this experiment?
2. How are the graphs of pressure versus temperature the same between acetone and ethyl alcohol?
3. How are the graphs of pressure versus temperature different between acetone and ethyl alcohol?

**Conclusion**

4. Based on the data and graph that you obtained for this experiment, what is the general relationship between pressure and temperature?
5. Is this relationship direct or indirect?

**Applications**

6. Based on your vapour pressure measurements at room temperature, which compound do you predict has stronger intermolecular forces at work? Explain your reasoning.
7. Define the term *volatile*. Which of the two liquids do you expect to be the least volatile? Why?
8. Why are most pressurized cans labelled with warnings not to dispose of the cans by throwing them into a fire?

## Appendix 1.11: Forces between Particles (Teacher Notes)

### Sample Data: Answer Key

#### Observations

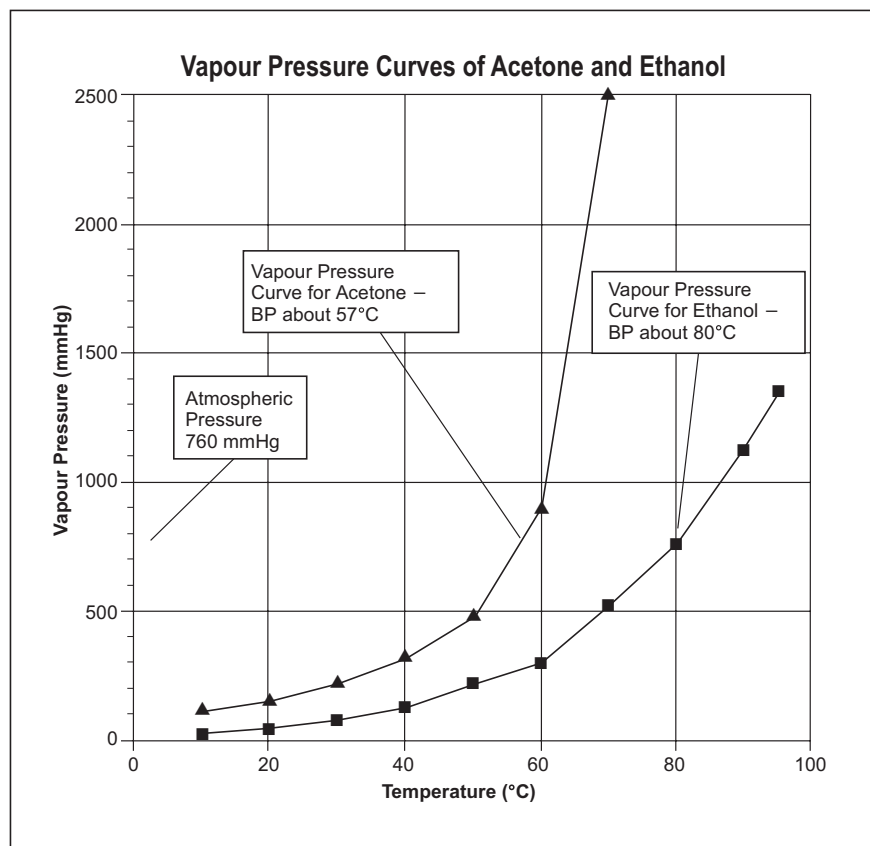

#### Analysis

1. The experimental factors that were kept constant during this experiment include the volume of the flask and the purity of the acetone and ethyl alcohol.
2. Both graphs have a similar sloping shape.
3. Acetone's graphed curve has a steeper slope.

#### Conclusion

4. As the temperature of a gas is decreased, its pressure also decreases. As the temperature of a gas is increased, its pressure also increases.
5. This relationship is direct.



Appendix 1.11: Forces between Particles (Teacher Notes) (*continued*)

---

**Applications**

6. Ethyl alcohol has stronger intermolecular forces at work. A larger amount of energy is required to overcome the stronger intermolecular forces that hold the liquid together.
7. *Volatile* means that a substance is easily vaporized at a lower temperature. Acetone is more volatile than ethyl alcohol.
8. With extremely high temperatures created by fire, the contents of pressurized cans will also become very high, resulting in possible explosions.

## Appendix 1.12: Freezing by Boiling

### Introduction

When a small amount of a liquid is added to a flask and evacuated at reduced pressure, the liquid boils. After a minute or so, the liquid freezes while it is boiling.

### Chemical Concepts

- vapour pressure
- boiling point
- triple point
- heat of vaporization

### Materials

- cyclohexane
- Erlenmeyer flask (125 mL) or a large test tube
- one-hole stopper to fit the flask or test tube
- medicine dropper
- aspirator with a splash guard
- 3 to 4 ft. of 3/16 in. (internal diameter) vacuum tubing
- boiling chips

### Procedure

1. Add 30 to 40 mL of cyclohexane and a boiling chip to a 125 mL Erlenmeyer flask or large test tube. Seal the flask or test tube with a rubber stopper attached to an aspirator. The glass part of a medicine dropper makes a convenient connector between the rubber stopper and the vacuum tubing.
2. Turn the water on completely and observe. Challenge a student to touch the test tube while it is boiling. Students believe the test tube will become hot. Continue to evacuate the system until the cyclohexane is completely frozen and no additional change occurs. Pass the flask containing the frozen cyclohexane around the room so that students can observe the temperature of the flask. The same sample of cyclohexane can be boiled again and the demonstration repeated if another boiling chip is added to the flask.

### Discussion

The aspirator lowers the pressure exerted on the cyclohexane until the vapour pressure of the liquid equals the applied pressure where the liquid boils. Since boiling is an endothermic process, the heat of vaporization is absorbed from its own kinetic energy, causing the temperature of the cyclohexane to drop until its freezing point of  $6.6^{\circ}\text{C}$  is reached. The cyclohexane will continue to boil while it is freezing at its triple point.

**Appendix 1.13: Gas Laws: Temperature and Pressure Changes**

---

**Question**

How does a decrease in pressure above a liquid affect its boiling point?

**Prediction**

Predict whether lowering the pressure of the atmosphere above a liquid will raise or lower its boiling point.

**Materials**

- computer system and temperature and pressure sensor
- 250 mL boiling flask (thick-walled)
- two-hole stopper (to fit into the flask)
- glass eyedropper stem (glass part only)
- distilled water
- boiling chips
- hot plate
- gloves or an insulating cloth
- support stand
- utility clamp
- a large pail of cold water
- utility pan (large enough to contain the pail's contents of water)

**Safety Precautions**

- Wear a lab apron and safety goggles.
- This experiment must be done carefully to avoid burns and broken glass.

**Procedure**

1. Set up the computer system with the temperature sensor and pressure sensor.
2. Display the temperature sensor with a graph (temperature vs. time) and the pressure sensor with a separate graph (pressure vs. time).
3. Add 10 boiling chips to the boiling flask and fill it one-third full of distilled water.
4. Insert the thermometer sensor into one of the two holes of the stopper so that its tip will be within the water in the flask when it is stoppered.
5. Insert the wide end of the glass eyedropper stem into the other outer hole of the stopper.
6. Connect the pressure sensor tube to the narrow tip of the glass eyedropper.
7. Set the support stand inside the utility pan and attach the utility clamp 30 cm from the base.

---

**Appendix 1.13: Gas Laws: Temperature and Pressure Changes** (*continued*)

---

- Heat the boiling flask (without the stopper) on the hot plate until the water is boiling.
- Start recording the data.
- Remove the distilling flask from the heat and immediately insert the stopper into the flask. The stopper must be inserted just before the water stops boiling. If the stopper is put in too soon, the pressure of the steam will blow it out. If it is put in too long after the boiling has stopped, air will have entered the flask and the experiment must be restarted.
- Attach the flask to the utility clamp.
- Slowly run cold water from the pail over the flask and observe any boiling.
- Continue until there is no more water to pour over the flask or the water in the flask no longer boils.
- Stop recording the data.
- Clean up the materials as directed by your teacher.

**Questions****Analysis**

- What was present above the water in the flask just before the stopper was inserted?
- What happened to the substance when cold water was run over the flask?
- How did the cold water poured over the flask create a lowered pressure inside of the flask?
- After the first of the cold water was poured, what was the temperature of the water inside the flask?
- At what temperature did you stop pouring water or at what point did the boiling stop?
- What can you conclude about the effect of lowering pressure on boiling?

**Applications**

- What is the name of the gas law that applies to both temperature and pressure? What is the formula?
- Is the relationship between pressure and temperature direct or indirect?
- At higher and higher altitudes the pressure decreases. Why would cooking potatoes in open pots not work at high altitudes?
- Suggest a practical method of boiling and cooking potatoes at high altitudes.

## Appendix 1.13: Gas Laws: Temperature and Pressure Changes (Teacher Notes)

### Sample Data: Answer Key

#### Observations

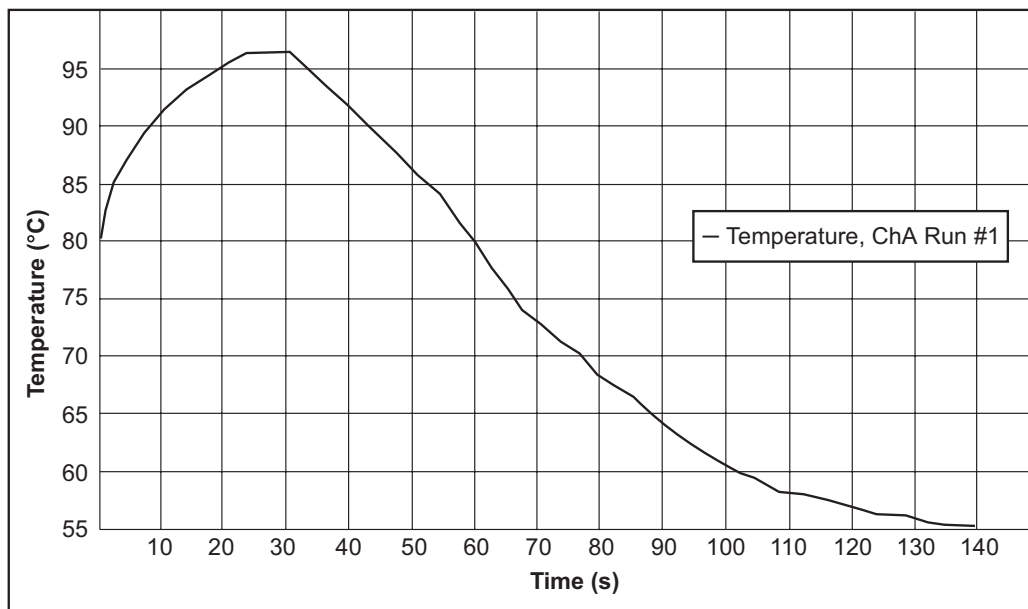

Graph 1: Temperature vs. Time

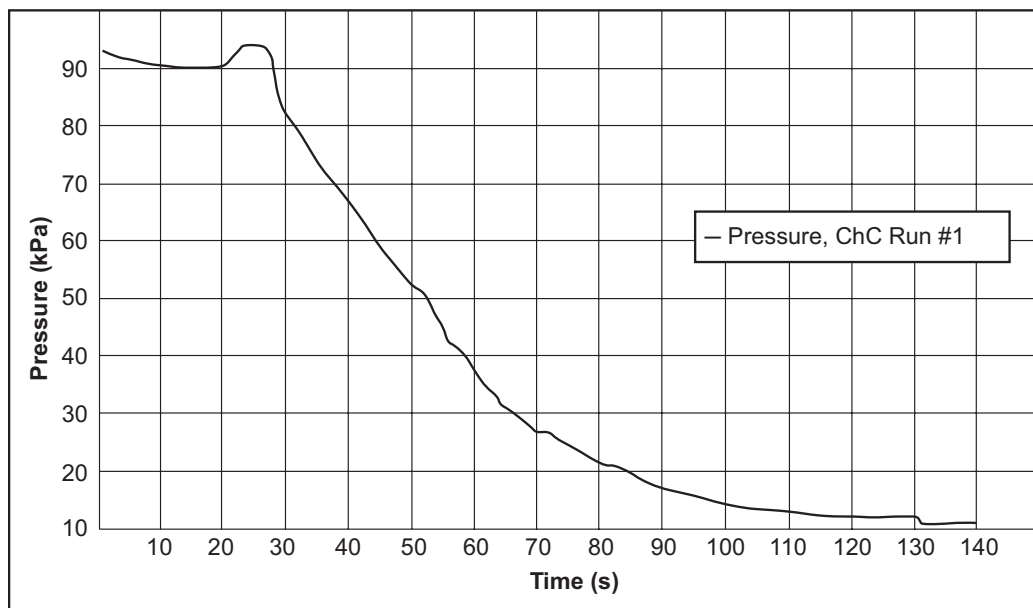

Graph 2: Pressure vs. Time

### Appendix 1.13: Gas Laws: Temperature and Pressure Changes (Teacher Notes) (continued)

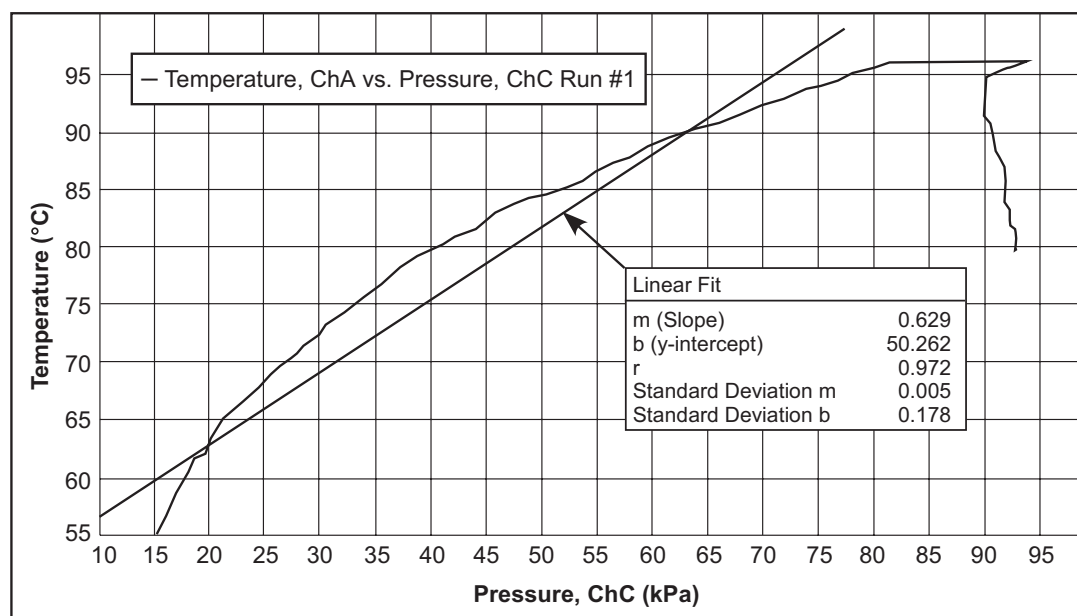

Graph 3: Temperature vs. Pressure

#### Analysis

1. Steam.
2. The substance condensed onto the inside of the flask.
3. Condensation requires the vapour particles to condense, resulting in a partial vacuum.
4. Around 99°C.
5. Around 60°C (depending on the temperature and amount of water in the pail).
6. Lowering pressure lowers the boiling point of a liquid.

#### Application

7. Gay-Lussac's Law. 
$$\frac{P_1}{T_1} = \frac{P_2}{T_2}$$
8. The relationship between pressure and temperature is direct.
9. The boiling temperature would not be hot enough to cook the potatoes.
10. Through the use of a pressure cooker.

**Appendix 1.14: Chemistry is Super: “Bingo” Review Game**

---

**Time:** 1 hour

**Purpose**

To review the learning outcomes and concepts addressed in Topic 1: Physical Properties of Matter.

**Game Instructions**

1. Supply each student with a minimum of two slips of paper.
2. Assign each student two learning outcomes/concepts from Topic 1. (Vary the outcomes from student to student so that all outcomes/concepts for this topic are addressed.)
3. Ask students to create a question related to each of their assigned learning outcomes/concepts, and explain that the questions will be used in the review game to follow. Each question must be written in such a way that the answer will be a one-word response (i.e., fill-in-the-blank). The answer should be included on the slip of paper, along with the question. (In order for the game to work, at least 40 questions and answers must be provided.)
4. As students finish their questions, collect and verify them, and start to create a Word Splash of all the answers on the classroom board. (Time allotment up to this point should be no more than 30 minutes.)
5. When all slips have been submitted, and an entire Word Splash is on the board, hand out the Chemistry Is Super game sheet.
6. Have students randomly place 25 of the words written on the board onto their game sheet (one word per square). If two words are the same, students can put it down twice on their game sheet if they want to.
7. The teacher (or student) can read the questions from the slips one at a time to the class. As students determine the correct answer to a question, they cross out the answer on their game sheet.
8. When a student successfully crosses out a line (any direction), he or she must clearly and enthusiastically call out “Chemistry Is Super” to win. Play can continue until the end of class and multiple winners can be awarded, if desired.
9. Answers can be shared or discussed within the class for additional review. The game can also be played silently, with individual students trying to determine the answers on their own.

**Game Sheet**

A copy of the Chemistry Is Super game sheet is provided on the following page.

Appendix 1.14: Chemistry is Super: "Bingo" Review Game *(continued)*

---

<b>Chemistry Is</b>				
<b>S</b>	<b>U</b>	<b>P</b>	<b>E</b>	<b>R</b>





# TOPIC 2:

## GASES AND THE ATMOSPHERE

### APPENDICES

---

Appendix 2.1: Can You Vacuum Pack a Person?	3
Appendix 2.2: A Historical Timeline of the Measurement of Pressure	4
Appendix 2.3: The Drinking Bird	7
Appendix 2.4: Make Your Own Cartesian Diver	10
Appendix 2.5: Charles's Law: The Temperature-Volume Relationship in Gases	14
Appendix 2.6: Charles's Law	16
Appendix 2.7: Charles's Law Lab	17
Appendix 2.8: Applications of Gases in Our Lives	19
Appendix 2.9: Topic-Review Game	22

**Note:**

Due to copyright considerations, the following appendices are not available:

Appendix 2.1: Can You Vacuum Pack a Person?

Appendix 2.4: Make Your Own Cartesian Diver



---

## Appendix 2.2: A Historical Timeline of the Measurement of Pressure

---

### Introduction

Your group must create a timeline of the following scientists who helped to develop the measurement of pressure into the concepts that we know today:

---

**Amadeo Avogadro**  
**John Dalton**  
**Galileo Galilei**  
**Joseph Louis Gay-Lussac**  
**Otto von Guericke**  
**Christiaan Huygens**  
**Blaise Pascal**  
**Evangelista Torricelli**

---

### Directions

The timeline must be created on poster paper and with markers so that it can be posted and seen easily. Use the biographies that have been supplied to you to get all the necessary information for each scientist. Create the appropriate timeline based on when the scientists made their important discoveries related to gases, and not based on the dates of their birth or their death. Give the poster a catchy title and be original in your presentation of the material on the poster. Remember, this is a group effort, so divide up the labour and be open to suggestions from every member of your group.

### Required Information

For each scientist, state the following:

- full name
- date of birth and date of death
- claim to fame related to gases (in three sentences or less)
- age at which the scientist made the “claim to fame” (approximate age is fine, if unclear)
- age at which the person died
- one other interesting piece of information

### Assessment

Groups in the class will assess each other’s timelines using the activity directions and the Peer-Assessment Rubric provided.

Appendix 2.2: A Historical Timeline of the Measurement of Pressure (continued)

Names of Students in Group:

\_\_\_\_\_

\_\_\_\_\_

Assessed by: \_\_\_\_\_

Three other groups will assess your timeline based on the directions provided for the activity and on the criteria identified in the rubric below. The three assessment results will be averaged and a mark can be assigned to each member of your group.

When your group is assessing another group, be sure to read each criterion carefully and assign appropriate marks that your group agrees upon.

Peer-Assessment Rubric				
Criteria	Rating			
	4	3	2	1
• How engaging is the title of the timeline poster?				
• How well are original materials and sources used and documented in the poster?				
• Are the scientists placed in the proper chronological order on the timeline?*				
• Are all historical dates and ages of persons in the timeline correct?*				
• How well has the person's "claim to fame" related to gases been addressed?				
• How interesting is the "interesting fact" about each scientist to you?				
• How informative, appealing, and effective is the overall poster to a teen audience?				

\* Reduce your rating by one level for each significant error of fact.

Overall Mark: \_\_\_\_\_ / \_\_\_\_\_

Constructive Comments: \_\_\_\_\_

\_\_\_\_\_

\_\_\_\_\_

\_\_\_\_\_

## Appendix 2.3: The Drinking Bird

### Observation Questions

The following questions could be asked as students observe the drinking bird in action:

1. Observe the drinking bird carefully and describe as many physical properties as possible.
2. How many states of matter are present in the bird system?
3. Draw one cycle of the drinking bird.
4. What causes the liquid to rise in the neck during a cycle?
5. What causes the bird to change position?
6. What is the purpose of the fuzzy head?
7. What is the purpose of the water on the head?
8. Will the bird continue to drink if the cup is removed?
9. What is the bird's energy source?
10. What kind of energy does the bird use?
11. What is the energy receiver?
12. Describe the energy chain.
13. How would you explain the operation of the drinking bird?
14. How many dips does the bird make per minute?
15. How would a breeze affect the rate of dipping?
16. How would direct or indirect sunlight affect the highest rate of dipping of the bird's head?
17. How would relative humidity affect the rate of dipping?
18. List the variables that you think would affect the rate of dipping.
19. How would you set up an experiment to determine which variables would produce the fastest rate of dipping?
20. What must you do to make the bird dip continuously?
21. Under what conditions will the bird fail to operate?
22. Describe the environment necessary for continuous and maximum operation.

The answers to the questions can be found in the background information provided in the Teacher Notes that follow.

## Appendix 2.3: The Drinking Bird (Teacher Notes)

---

The head, neck, and body of the drinking bird are interconnected hollow chambers. These chambers, from which air has been evacuated, contain a volatile liquid and its vapour (a two-phase system). The volatile liquid has a low heat of vaporization, high density and pressure, and a boiling point near normal room temperature. When the fuzzy head of the drinking bird is dry, the temperature is uniform throughout the bird, and the vapour pressure in the top chamber is equal to the vapour pressure in the bottom chamber. The bird is in a state of static equilibrium (that is, it is not working).

Once the head is wet, the vapour pressure in the top and bottom chambers becomes unequal. When the head is moistened, the water on the surface begins to evaporate, cooling the head area. As the water from the head evaporates, it extracts heat from the top chamber of the bird. (Heat is also absorbed from the surrounding air, but that does not affect the operation of the bird.) As a consequence, the temperature inside the top chamber falls. This cooling reduces the vapour pressure in the head area, causing the gas pressure in the bottom chamber to become greater than that in the top chamber. This pressure difference forces the liquid up the tube and into the head. To summarize, the wet beak leads to

- lowering of the pressure in the top chamber
- a pressure gradient between the two chambers
- elevation of the liquid column

As the evaporation from the head proceeds, the pressure in the top chamber continues to fall and the liquid column continues to rise. The bird becomes top-heavy and tips over, but is stopped before reaching a horizontal level because the liquid in the lower end of the tube becomes higher than that in the bottom chamber. Thus, the rise in the liquid column is arrested by the bird tipping when its centre of gravity, which rises as the liquid column rises, falls outside the stem. At this moment there is a break in the liquid column, and contact is established between the two chambers. Thus, the liquid in the upper chamber returns by gravity to the lower bulb, while, simultaneously, the gas in the lower chamber bubbles up into the head. The vapour pressure and temperature again become uniform throughout the volume of the bird, and it returns to the original vertical position. The cycle repeats since evaporation from the head continues; the bird will continue to dip as long as there is a sufficient difference in temperature between the top and bottom chambers.

From the above description it follows that the drinking bird is a heat engine that converts heat of evaporation into work through rotational motion. The “fuel” for this work happens to be water that undergoes no chemical transformation. Like other heat engines, this machine performs work because of the temperature difference between the heat source and the heat sink. The source in this case, however, is at the ambient temperature and the sink (water on the beak) is at a lower temperature.

**Appendix 2.3: The Drinking Bird (Teacher Notes)** *(continued)*

---

Since we live in an energy-conscious age, it is worth reminding students of this distinction between power and energy. The drinking bird illustrates a very interesting relationship between power and energy. The efficiency increases linearly as the column height increases; if the liquid column height is increased by a factor of 2, energy efficiency doubles. The power efficiency, however, does not change. This is because the time it takes to reach the full height is also doubled, since the rate of evaporation is constant. When the height of the column is doubled, both energy output and the time it takes to complete a cycle are doubled, and the power remains constant.



## Appendix 2.5: Charles's Law: The Temperature-Volume Relationship in Gases

---

### Introduction

The primary objective of this experiment is to determine the relationship between the temperature and volume of a confined gas. The gas we use will be air, and it will be confined in a syringe. When the temperature of the syringe is changed by placing it in different water baths, a change occurs in the volume of a confined gas. This volume change will be monitored using the gradations on the syringe. It is assumed that pressure will be constant throughout the experiment. Temperature and volume data pairs will be collected during this experiment and then analyzed. From the data and graph, you should be able to determine what kind of mathematical relationship exists between the temperature and volume of the confined gas. Historically, this relationship was first established by Jacques Charles around 1790 and has since been known as Charles's Law.

### Materials

- syringe (60 cc)
- modified rubber stopper (size zero)
- 5 beakers (1 L)
- test-tube clamp
- thermometer and clamp
- hot plate
- water
- ice
- ring stand

### Procedure

1. Prepare water baths of about 0°C, 20°C (room temperature), 50°C (hot tap water), 80°C, and 95°C. For each water bath, mix varying amounts of hot water from a hot plate, cool water, and ice to obtain a volume of 800 mL in a 1 L beaker. To save time and beakers, several lab groups can use the same set of water baths.
2. Draw out the plunger of the syringe so that the lower portion of its rubber ring is set at the 30 cc mark. To contain this volume of air, cap the tip with the modified rubber stopper.
3. a) Set up the ring stand, test-tube clamp, syringe, thermometer clamp, and thermometer.  
b) Place the syringe and thermometer into the ice-water bath and wait five minutes so that the gas and thermometer will equilibrate to the temperature of the water bath.  
c) Gently press down the plunger a little and release it to reduce some friction between the plunger and the wall of the syringe.  
d) Wait 30 seconds, and then record both the volume and the temperature of the gas in the data table.

## Appendix 2.5: Charles's Law: The Temperature-Volume Relationship in Gases (continued)

4. Repeat step 3 with water baths of 20°C (room temperature), 50°C, 80°C, and 95°C. Be sure to record the data after each measurement.

Observations		
Volume (cc)	Temperature (°C)	Temperature (K)

**Graph**

1. Generate a graph of volume (cc) vs. temperature (°C) from your data. Be sure to include labelled axes, appropriate scales, units, and a title.
2. Extend the curve by extrapolation and identify what temperature is theoretically required to reduce the volume to 0 cc. This Celsius temperature is referred to as *absolute zero* on the Kelvin scale.

**Conclusion**

Make a statement about the relationship between the temperature of a gas and its volume. Identify the temperature required to reduce the volume of a gas to 0 cc.

**Questions**

1. Calculate the percentage error in your Celsius value for absolute zero:

$$\% \text{ error} = \left| \frac{\text{experimental result} + 273}{273} \right| \times 100\%$$

2. Based on the graph that was generated from your data, are temperature and volume directly or inversely related to one another? Explain your answer.
3. Indicate some sources of error.

## Appendix 2.6: Charles's Law

### Sample Student Data

The following graph is typical of student-generated data for volume versus temperature. It is important, particularly historically, to extrapolate down to a theoretically "absolute" low temperature that implies "no volume," and hence argues for no molecular kinetic activity – that is, an absolute zero (approximately  $-273^{\circ}\text{C}$  or 0 K).

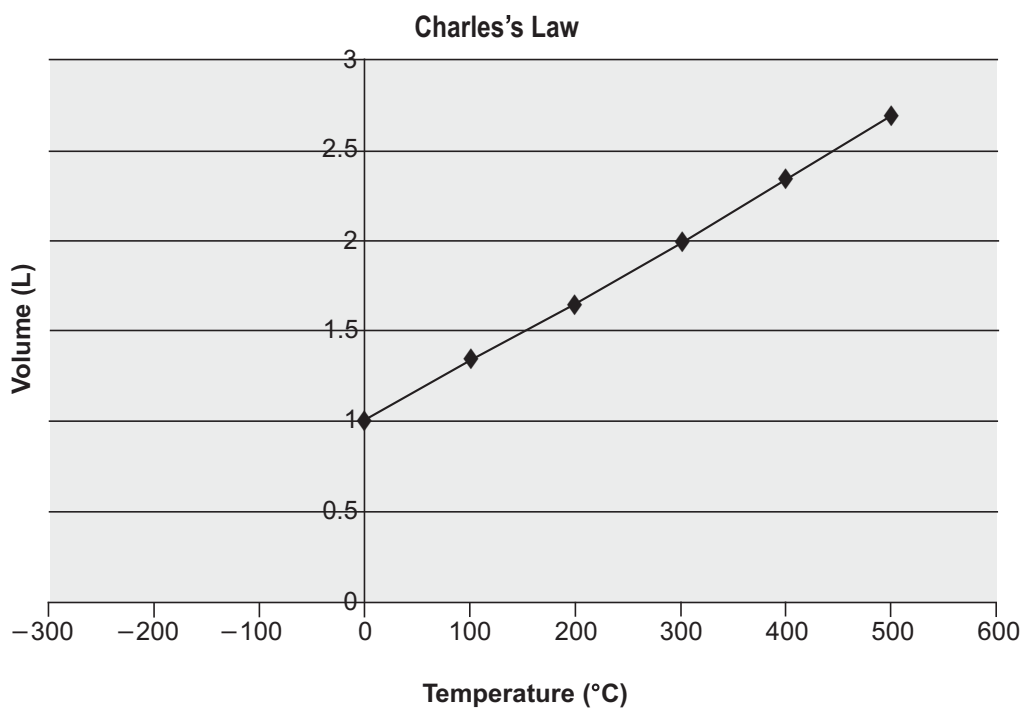

## Appendix 2.7: Charles's Law Lab



1. Go to the website of The North Carolina School of Science and Mathematics, Distance Learning Technologies, Teachers' Instructional Graphics Educational Resource (TIGER): <http://www.dlt.ncssm.edu/TIGER/chem3.htm>.

Search the sample simulation links at the website to find one entitled **CharlesLaw.html**. Or, if you prefer, download the executable file marked as **CharlesLaw.exe**.

- a) Explore this simulation.
- b) Fill in the following to make a correct statement.

Charles's Law shows the relationship between \_\_\_\_\_ and \_\_\_\_\_ when the \_\_\_\_\_ is constant.

2. Go to the website of Thomas J. Greenbowe, Department of Chemistry, Iowa State University: [http://www.chem.iastate.edu/group/Greenbowe/sections/projectfolder/flashfiles/gaslaw/charles\\_law.html](http://www.chem.iastate.edu/group/Greenbowe/sections/projectfolder/flashfiles/gaslaw/charles_law.html).

- a) Manipulate the simulation to get a set of data.
- b) Graph the data.

### Graph

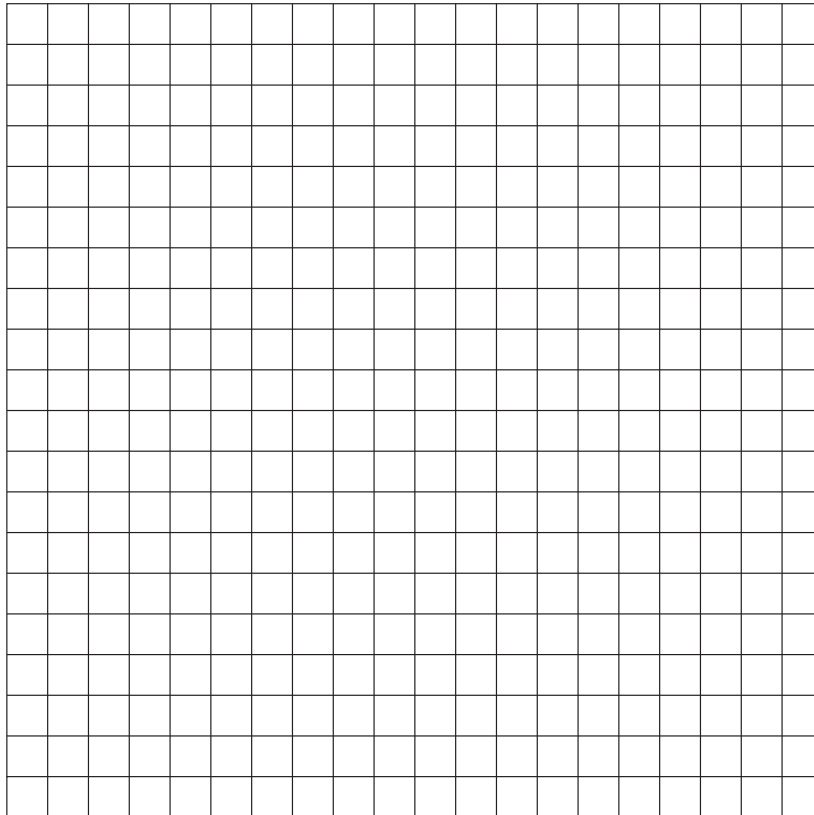

### Appendix 2.7: Charles's Law Lab (*continued*)

---

3. Using the Internet and your own prior knowledge (think about Boyle's Law), fill in the following:
  - a) Charles's Law states:
  
  
  
  
  
  
  
  
  
  
  - b) The relationship is directly proportional. Therefore, the equation is:
  
  
  
  
  
  
  
  
  
  
  - c) We can compare a gas when its situation changes by using the formula:
  
  
  
  
  
  
  
  
  
  
  - d) We can also extrapolate the graph to find absolute zero.

*Example:*

A balloon is filled with 3.0 L of helium at 22°C and 760 mmHg. It is then placed outdoors on a hot summer day when the temperature is 31°C. If the pressure remains constant, what will the volume of the balloon be?

## Appendix 2.8: Applications of Gases in Our Lives

---

### Research Presentation

Your group will randomly receive one of the following research topics and will present information to the class in the form of a five-minute presentation and a written one-page handout for your classmates.

1. acetylene welding or oxy-fuel gas welding
2. air bags
3. airships
4. anaesthetics
5. hyperbaric chambers
6. propane appliances
7. self-contained underwater breathing apparatus (scuba)

If your selection is not appealing to your group, or if you are having difficulty finding relevant source material (which is unlikely), then you may select your own topic, with the advice of your teacher. Your own selected topic must be approved by the teacher and must be related to an industrial, environmental, or recreational application of gases or the gas laws.

### Assessment

Groups in the class will assess each other's presentations and handouts using the Peer-Assessment Rubric provided.

Appendix 2.8: Applications of Gases in Our Lives (continued)

Names of Students in Group:

\_\_\_\_\_

\_\_\_\_\_

Assessed by: \_\_\_\_\_

Please assess your classmates carefully, according to the criteria listed below. Be prepared to justify your ratings if required to do so as an oral follow-up. In addition, leave constructive comments that will aid students in improving their future presentations.

Peer-Assessment Rubric				
Criteria	Rating			
	4	3	2	1
<b>Student Presentation</b>				
1. <b>Preparation:</b> Class time was used effectively. Group appears ready to present results to class.				
2. <b>Clarity of Expression:</b> Presenters speak clearly and with enough volume for everyone to hear clearly.				
3. <b>Organization:</b> Concept is presented in a logical, consistent way.				
4. <b>Information:</b> Information is accurate, thorough, and current.				
5. <b>Audience Engagement:</b> Class is attentive to the presentation.				
6. <b>Originality:</b> Something was done in the presentation that made it different from your expectations.				
7. <b>Presenting with Understanding:</b> The group clearly understands the material, and can refrain from reciting from a prepared text.				
<b>Student Handout(s)</b>				
8. <b>Accuracy of Content:</b> The content is scientifically and technologically accurate.				
9. <b>Organization of Content:</b> The content is easy to follow (e.g., it was assembled with a student audience in mind).				
10. <b>Appearance:</b> The handout is clearly written, free of grammatical errors, and easy to follow.				

Overall Mark: \_\_\_\_\_/40

Mark Scaled to: \_\_\_\_\_/20

(continued)

Appendix 2.8: Applications of Gases in Our Lives (*continued*)

---

**Constructive Comments:**



## Appendix 2.9: Topic-Review Game

---

### Purpose

To review the learning outcomes and concepts addressed in Topic 2: Gases and the Atmosphere.

### Game Instructions

1. Form two groups: Team A and Team B.
2. Team A plays against Team B, so the teams sit opposite each other at a table.
3. Team A and Team B will each receive a separate set of 10 questions.  
(**Note:** Answers are also found on the question sheets, so don't show your opponent the answers.)
4. You will need the following materials:
  - calculator
  - pen/pencil
  - scrap paper
  - your reference sheet with formulas and conversions on it
5. Team A asks Team B a question, selected at random from the assigned set of questions.
6. Students in Team B attempt to answer the question. If they get it right, they get one point. If they get it wrong, they do not get a point, but both teams can help solve the problem until they understand the question. (Remember that you are doing this activity in order to review and to be better prepared for your test.)
7. Team B now asks Team A a question, selected at random from the assigned set of questions.
8. Students in Team A attempt to answer the question. They, too, get a point if they get the right answer, and they must try to understand where they went wrong if they do not get the correct answer.
9. Play continues until all 10 questions from each set of questions have been answered.
10. The team with the most points will receive a bonus mark on the test.
11. Keep a tally sheet of your results and hand it in when the review game ends. Group names must be on the sheet.

## Appendix 2.9: Topic-Review Game (continued)

Team A	Team B
<p><b>Q.</b> The most important gases in the environment are oxygen, nitrogen, carbon dioxide, and water vapour. (True or False)</p> <p><b>A.</b> True</p>	<p><b>Q.</b> The gases of our atmosphere are not needed for photosynthetic activity in plants. (True or False)</p> <p><b>A.</b> False</p>
<p><b>Q.</b> The international agreement called the _____ Protocol will cut down on the carbon dioxide that goes into the air each year.</p> <p><b>A.</b> Kyoto</p>	<p><b>Q.</b> CEPA stands for The Canadian Environmental _____ Act. Its intent is to protect Canada's environment and human health.</p> <p><b>A.</b> Protection</p>
<p><b>Q.</b> _____'s "claim to fame" was that he showed that a vacuum does exist.</p> <p><b>A.</b> Pascal</p>	<p><b>Q.</b> Torricelli's "claim to fame" was that he invented the _____.</p> <p><b>A.</b> barometer</p>
<p><b>Q.</b> 738 mmHg = _____ atm</p> <p><b>A.</b> 0.971 atm</p>	<p><b>Q.</b> 98.7 kPa = _____ psi</p> <p><b>A.</b> 14.3 psi</p>
<p><b>Q.</b> 32.0 psi = _____ atm</p> <p><b>A.</b> 2.18 atm</p>	<p><b>Q.</b> 2.3 atm = _____ kPa</p> <p><b>A.</b> 232.99 kPa</p>
<p><b>Q.</b> A gas occupies a volume of 458 mL at a pressure of 1.01 kPa. When the pressure is changed, the volume becomes 477 mL. If there has been no change in temperature, what is the new pressure?</p> <p><b>A.</b> 0.970 kPa</p>	<p><b>Q.</b> A gas occupies a volume of 2.45 L at a pressure of 1.03 atm and a temperature of 293 K. What volume will the gas occupy if the pressure changes to 0.980 atm and the temperature remains unchanged?</p> <p><b>A.</b> 2.58 L</p>
<p><b>Q.</b> A tank of compressed CO<sub>2</sub> has a temperature of 23.6°C and a volume of 31.4 L. The CO<sub>2</sub> is completely transferred into a smaller tank that has a volume of 25.0 L. Assuming none of the CO<sub>2</sub> escapes during the transfer, what is the temperature of the CO<sub>2</sub> in the smaller tank if the temperature is lowered to achieve the same pressure as that in the larger tank?</p> <p><b>A.</b> -36.9°C</p>	<p><b>Q.</b> What will be the volume of a gas sample at 309 K if its volume at 215 K is 3.42 L? Assume that the pressure is constant.</p> <p><b>A.</b> 4.92 L</p>
<p><b>Q.</b> Seaweed plants release oxygen gas during photosynthesis. A 0.10 mL bubble is released underwater at a pressure of 176 kPa and a temperature of 10°C. What volume will this bubble occupy at the surface, where the temperature is 15°C and the pressure is 101.3 kPa?</p> <p><b>A.</b> 0.18 mL</p>	<p><b>Q.</b> An air-filled balloon has a volume of 225 L at 0.94 atm and 25°C. Soon after, the pressure changes to 0.99 atm and the temperature changes to 0°C. What is the new volume of the balloon?</p> <p><b>A.</b> 196 L</p>
<p><b>Q.</b> Which scientist stated that the pressure of a gas is inversely proportional to its volume?</p> <p><b>A.</b> Boyle</p>	<p><b>Q.</b> Which scientist stated that the volume of a gas is directly proportional to its temperature?</p> <p><b>A.</b> Charles</p>
<p><b>Q.</b> What are the final products of the second stage that acetylene welding goes through?</p> <p><b>A.</b> carbon dioxide and water vapour</p>	<p><b>Q.</b> When dealing with anaesthetics, it is important to know that the more _____ the gas is in the blood the longer it takes to eliminate it from the body.</p> <p><b>A.</b> soluble</p>



# TOPIC 3: CHEMICAL REACTIONS

## APPENDICES

---

- Appendix 3.1: Calculating Average Atomic Mass 3
- Appendix 3.2: Don't Be an Isotope: Get the Facts on Isotopes 5
- Appendix 3.3: Isotopes Used in Medicine and Climatology 9
- Appendix 3.4: The Importance and Application of Isotopes 10
- Appendix 3.5: Names, Formulas, and Charges of Some Common Ions 18
- Appendix 3.6: Ionic Name Game 19
- Appendix 3.7: Stoichiometry: The Formula of a Precipitate 20
- Appendix 3.8: Indications of Chemical Reactions 26
- Appendix 3.9: Determining the Molar Mass of a Gas 31
- Appendix 3.10: Gas Density Table 35
- Appendix 3.11: Creative Mole: Writing Activity 36
- Appendix 3.12: The Stoichiometry of Gasoline: Internet Research Activity 37
- Appendix 3.13: How to Solve a Limiting Reactant Problem 38
- Appendix 3.14: The Behaviour of Solid Copper Immersed in a Water Solution of the Compound Silver Nitrate 39
- Appendix 3.15: A Quantitative Investigation of the Reaction of a Metal with Hydrochloric Acid 43
- Appendix 3.16: Stoichiometry: Reactants, Products, and Enthalpy Changes 48



## Appendix 3.1: Calculating Average Atomic Mass

1. Identify the numbers of protons, neutrons, and electrons in a neutral atom of each of the following:

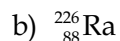
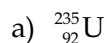

2. Complete the following table to calculate the average atomic mass of chlorine (Cl).

Isotope	Mass of Each Atom	Number of Atoms	Total Mass
Cl-35	34.969 $\mu$	758	
Cl-37	36.966 $\mu$	242	
Totals		1000	
Average			

3. Complete the following table to calculate the average atomic mass of each element.

Element	Symbol	Mass Number	Mass ( $\mu$ )	Relative Abundance (%)	Average Atomic Mass ( $\mu$ )
Carbon (C)	C-12	12	12 (exactly)	98.98	
	C-13	13	13.003	1.11	
Silicon (S)	Si-28	28	27.977	92.21	
	Si-29	29	28.976	4.70	
	Si-30	30	29.974	3.09	

## Appendix 3.1: Calculating Average Atomic Mass (continued)

4. Define the term *isotope*. Explain how an element's atomic mass is related to the abundances of its different isotopes.

5. Using the graph below, calculate the average atomic mass of copper (Cu).

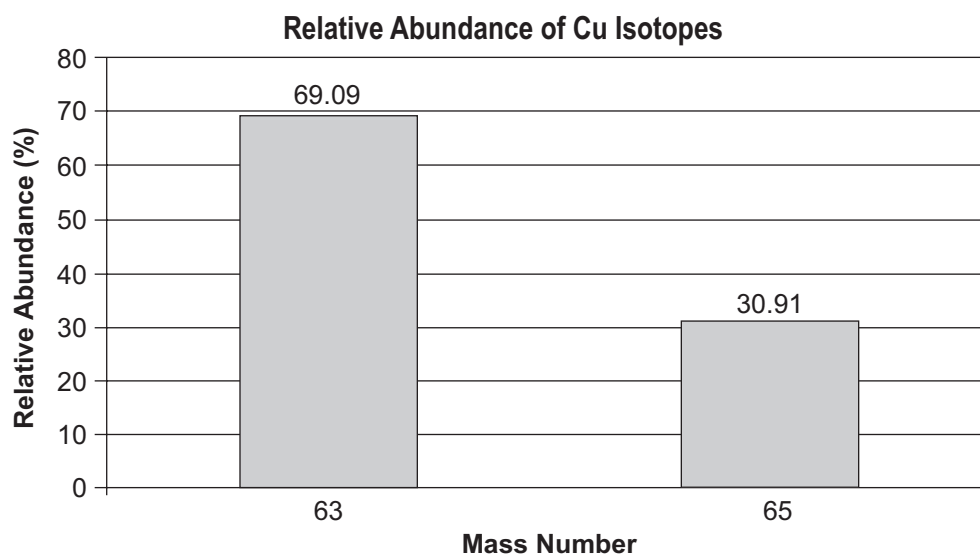

## Appendix 3.2: Don't Be an Isotope: Get the Facts on Isotopes

Any single atomic element has a fixed number of protons. However, nearly all elements are capable of possessing more than one fixed number of neutrons. For example, hydrogen is defined as an atom with only one proton. Hydrogen commonly has zero neutrons, giving this type of atom an atomic mass of 1. This means that  $6.0225 \times 10^{23}$  (one mole) of these common hydrogen atoms weighs 1 gram. However, every once in a while a hydrogen atom will also have a neutron, which has basically the same mass as a proton. These heavier hydrogen atoms are referred to as  $^2\text{H}$ , or deuterium, and have an atomic mass of 2. Even more rarely, a hydrogen atom will have two neutrons. These atoms have an atomic mass of 3 and are referred to as  $^3\text{H}$ , or tritium.  $^1\text{H}$ ,  $^2\text{H}$ , and  $^3\text{H}$  are all *isotopes of hydrogen*.

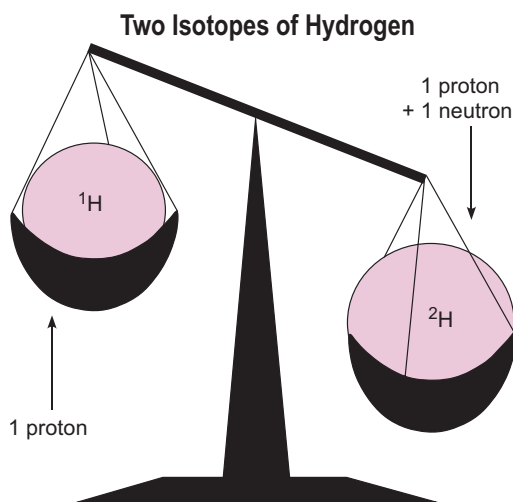

Some isotopes are classified as stable isotopes and others are classified as unstable, or radioactive, isotopes. Stable isotopes maintain constant concentrations on Earth over time. Unstable isotopes are atoms that disintegrate at predictable and measurable rates to form other isotopes by emitting a nuclear electron or a helium nucleus and radiation. These isotopes continue to decay until they reach stability. As a rule, the heavier an isotope is than the most common isotope of a particular element, the more unstable it is and the faster it will decay.

Because the rates of radioactive decay are measurable, unstable isotopes are useful tools in determining age. For example, nuclear bombs put large and detectable amounts of certain radioactive isotopes into the atmosphere. After the near-elimination of nuclear bomb testing due to the Limited Test Ban Treaty in 1963, the carbon-14 concentration in the atmosphere began decreasing immediately. Therefore, someone born in 1965 has a significantly lower concentration of carbon-14 in the bones than a person who was born in 1960. Anybody born after

**Don't Be an Isotope: Get the Facts on Isotopes:** Copyright © by Park Williams. Adapted by permission of the author from: <<http://www.geog.ucsb.edu/~williams/Isotopes.htm>>.



## Appendix 3.2: Don't Be an Isotope: Get the Facts on Isotopes (continued)

1965 or so possesses a significantly lower concentration of carbon-14 than someone born before atmospheric nuclear testing came to a close. Thus, we can tell how old many living organisms are based on the recent history of carbon-14 in the atmosphere from nuclear tests! Because carbon-14 decays slowly (decreases to half of its original concentration every 5,370 years), we can also tell how long ago much older organisms died, based upon what we know the pre-industrial carbon-14 concentration in the atmosphere was and how much radioactive decay of this isotope has occurred since the organism's death. This is a very useful tool in dating petrified wood, bones from ancient civilizations, and shells in ocean-floor sediments. For very old specimens such as dinosaur bones, more stable radioactive isotopes must be used because of their slower decay rates.

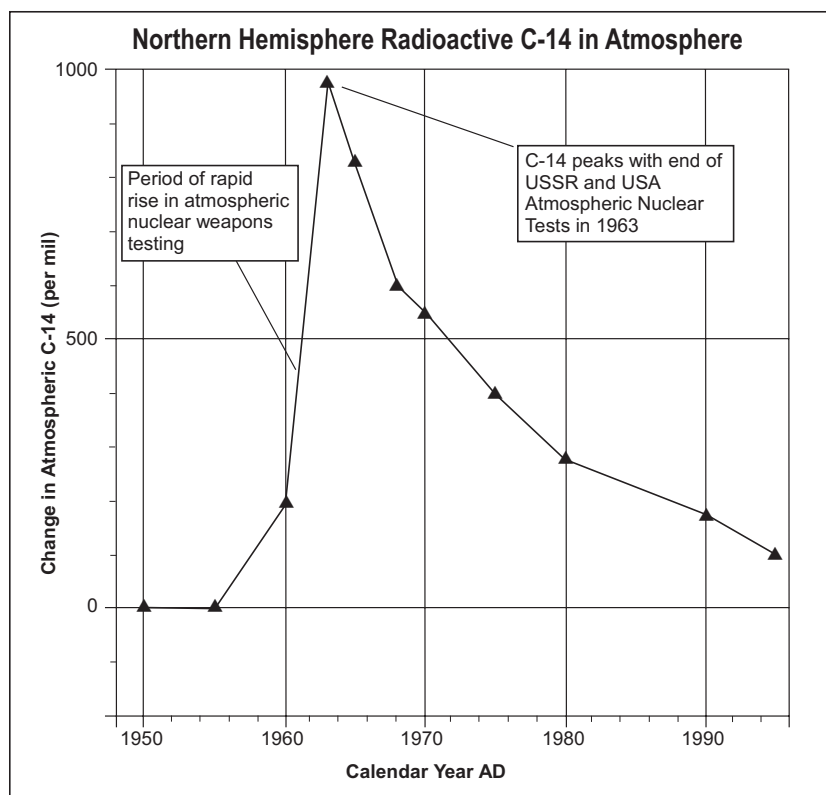
**Teacher Notes**

During the Cold War, the USA and USSR conducted numerous atmospheric atomic weapons tests. Those events are recorded in the history of radioactive C-14 that was contained in Earth's atmosphere.

The year 1963 was the end of atmospheric testing, as the Nuclear Test Ban Treaty was signed by both competing nations. Even after 40 years, some residual radioactive carbon is being scrubbed out of the atmosphere in precipitation.

Appendix 3.2: Don't Be an Isotope: Get the Facts on Isotopes (continued)

While radioactive isotopes are very cool, you may be looking for a little more stability in your life, and are therefore interested in *stable isotopes*. Because stable isotopes don't decay, they remain in the environment at a constant concentration. However, the distribution of stable isotopes throughout the environment constantly changes as a result of changing environmental preferences. For example, much like salinity, the concentrations of heavy hydrogen and oxygen isotopes in the ocean increase significantly during glacial periods because cold air is not as good at absorbing and holding onto heavy water molecules as warm air is. This means that water molecules made of light hydrogen and oxygen isotopes evaporate from the ocean more easily than heavy molecules.

During glacial times, much more water is trapped on land as ice than during interglacial times, redistributing the light water molecules that preferentially evaporated from the ocean onto land. Trapping water on land decreases the volume of the ocean and therefore increases the concentration of heavy hydrogen and oxygen isotopes in the ocean. Because the concentration of these heavy isotopes in the ocean is a function of temperature, the environment has been keeping a record of sea surface temperature for millions of years by the constant piling up of dead organic matter on the ocean floor (sedimentation). For example, Foraminifera living

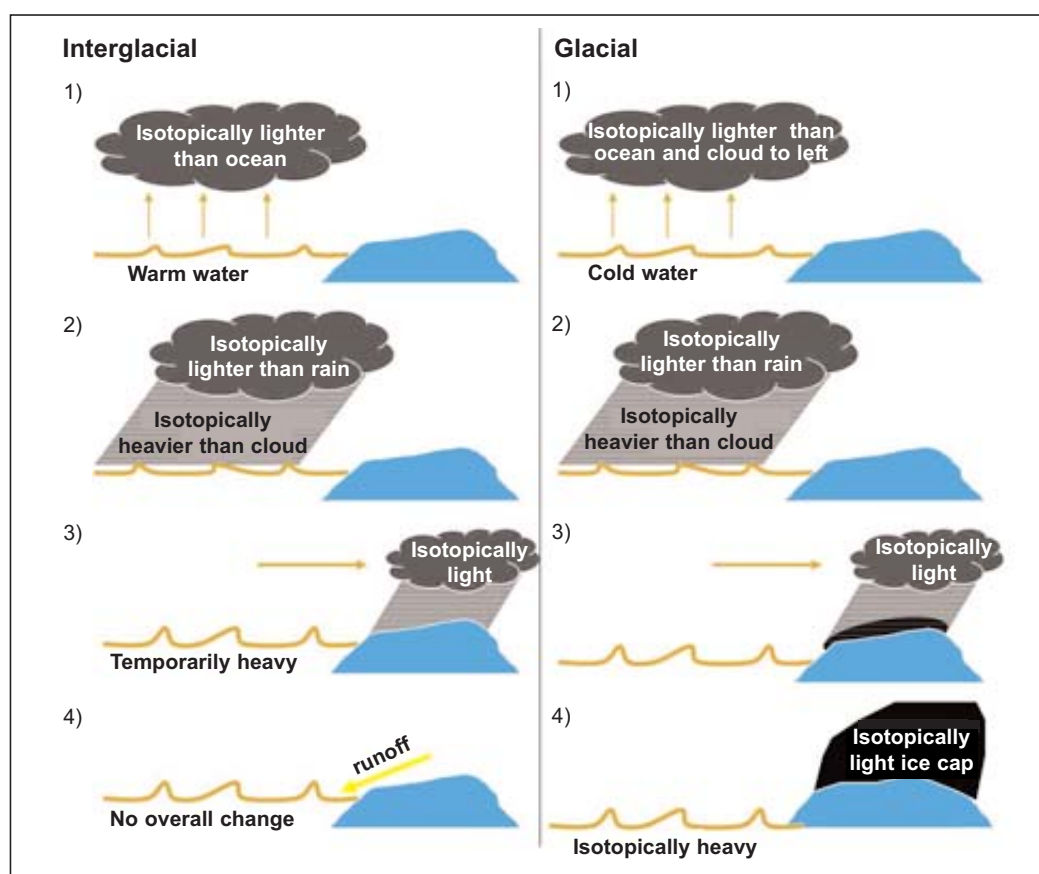

**Appendix 3.2: Don't Be an Isotope: Get the Facts on Isotopes** *(continued)*

---

at the ocean's surface make their calcium carbonate,  $\text{CaCO}_3$ , shells out of the chemistry they pull out of the ocean. If the ocean is changing its isotopic composition over time, and if these shells are constantly falling to the ocean floor as new shells are created, then measuring concentrations of heavy oxygen isotopes in shells going down in depth from the ocean floor is like travelling back in time and measuring sea surface temperature over millions of years.

There are many other processes that influence the preferential distribution of other heavy and light isotopes as well. For example, the concentration of nitrogen-15 ( $^{15}\text{N}$ ) in an animal indicates whether or not that animal is starving. The combination of nitrogen-15 and carbon-13 in a human indicates how much meat that person eats, and comparing these measurements around the world can tell us much about dietary differences from country to country. Changes in carbon-13 concentration throughout the hoof of a herbivore, such as a deer, can indicate drought because of changes in chemistry of the plants that the deer eats, and changes in carbon-13 of bones from 10 million to 3 million years ago indicate a significant change from woody plants (C3) to grasses (C4) about 5 million years ago.

### Appendix 3.3: Isotopes Used in Medicine and Climatology

Isotope	Application	Use	Radiation	Half-Life
Sodium-24	Medical radioactive tracer	<ul style="list-style-type: none"> <li>to detect blood flow constrictions and obstructions</li> </ul>	Beta emitter	14.8 h
Iodine-131	Medical radioactive tracer	<ul style="list-style-type: none"> <li>to test the activity of the thyroid gland</li> </ul>	Beta emitter	8 d
Technetium-99	Medical radioactive tracer	<ul style="list-style-type: none"> <li>to image organs such as heart, liver, and lungs</li> <li>to do 3-phase bone scans</li> </ul>	Gamma emitter	6 h
Cobalt-48	Medical radioactive tracer	<ul style="list-style-type: none"> <li>to determine intake of vitamin B12 that contains non-radioactive cobalt</li> </ul>		71.3 d
Iron-59		<ul style="list-style-type: none"> <li>to determine the rate of red blood cell formation (they contain iron)</li> </ul>		45.6 d
Chromium-51		<ul style="list-style-type: none"> <li>to determine blood volume and lifespan of red blood cells</li> </ul>		27.8 d
Hydrogen-3 Tritium		<ul style="list-style-type: none"> <li>to determine volume of water in person's body</li> <li>to determine the use of (labelled) vitamin D in body</li> <li>to conduct cellular chemistry research</li> </ul>		12.3 y
Strontium-85		<ul style="list-style-type: none"> <li>to do bone scans</li> </ul>		64 d
Gold-198		<ul style="list-style-type: none"> <li>to do liver scans</li> </ul>		2.7 d
Phosphorus-32		<ul style="list-style-type: none"> <li>to determine eye disorders, liver tumours</li> </ul>		14.3 d

Radioisotope tracers are used for diagnosis in medicine. One advantage of using radioactive isotopes is that their particle emissions are straightforward to detect. Photographic imaging techniques or the use of devices known as scintillometers (counters) can detect their presence even in small amounts.

## Appendix 3.4: The Importance and Application of Isotopes

During today's class, you will find information about the following isotopes:

Aluminum-26	Nitrogen-14
Americium-241	Nitrogen-15
Bismuth-213	Oxygen-15
Calcium-42	Oxygen-16
Calcium-44	Oxygen-18
Californium-252	Phosphorus-32
Carbon-13	Plutonium-238
Carbon-14	Polonium-210
Cesium-137	Promethium-147
Cobalt-60	Rhenium-188
Deuterium (Hydrogen-2)	Rubidium-82
Fluorine-18	Silicon-32
Gold-198	Sodium-24
Iodine-125	Strontium-90
Iodine-131	Technetium-99m
Iridium-192	Thorium-229
Krypton-85	Tritium (Hydrogen-3)
Lead-206	Uranium-238
Nickel-62	Vanadium-5

Isotopes are made in particle accelerators or nuclear reactors. As they decay over time (some quite quickly), parent isotopes are manufactured so that the desired isotope is made through decay during storage or transport.

The isotope products can be used in

1. medical diagnosis
2. medical treatment
3. agriculture
4. science
5. industry and business
6. consumer products and services

In the computer lab, use WebQuests to research the importance and applications of isotopes. The following two websites will be especially useful:



- Environment Canada. "Isotopes Link Birds to Breeding and Moulting Areas." *Science and the Environment Bulletin*. (May/June 2001): <[www.ec.gc.ca/science/sandemay01/article7\\_e.html](http://www.ec.gc.ca/science/sandemay01/article7_e.html)>
- Nuclear Energy Institute (NEI): <[www.nei.org/index.asp?catnum=1&catid=1](http://www.nei.org/index.asp?catnum=1&catid=1)>

Based on your research on the importance and applications of the isotopes listed above, complete the left column of the charts on the following pages. Please note that some isotopes may be used more than once.

## Appendix 3.4: The Importance and Application of Isotopes (continued)

## 1. Medical Diagnosis

Isotopes can identify abnormal bodily processes, because some natural elements tend to concentrate in certain internal organs. After a patient has been injected with an isotope, a special camera can take pictures of the internal workings of the patient's body. Nuclear medicine was developed in the 1950s.

Isotope	Use
• •	PET (positron emission tomography) scans use these two isotopes to measure energy metabolism in the brain.
•	This isotope is used to image the thyroid, heart, lungs, and liver. It also measures blood iodine levels.
•	Injected into the bloodstream as a salt solution, this isotope can be monitored to trace blood flow in order to detect constrictions and obstructions in the circulatory system (i.e. prevent a heart attack).
•	This isotope is used in cardiac (heart) imaging because its chemical reactivity is similar to that of potassium (which is used in muscles, such as the heart). Once the isotope reaches the heart, a PET image can be made. The isotope decays away within a day.
•	This isotope helps diagnose bone infection in children, as well as brain tumours.
•	This isotope is used to detect <i>helicobacter pylori</i> (which can damage the stomach lining and lead to ulcer formation) in the human stomach. If the bacteria are there, they will ingest the isotope and produce $^{13}\text{CO}_2$ that will be exhaled at a higher concentration than normal.

## Appendix 3.4: The Importance and Application of Isotopes (continued)

## 2. Medical Treatment

The direct internal or external application of isotopes is superior to chemotherapy because the isotopes are specific to the tumour or cancer involved, and cause less damage to healthy tissue.

Isotope	Use
•	This isotope fights lung cancer and leukemia.
•	Implants of this isotope, or mixtures of Strontium-90 and Ytterbium-90, are used to destroy pituitary and breast cancer tumours.
•	Gamma rays from this isotope are used to destroy brain tumours.
•	This isotope is used as a therapeutic seed implant for prostate cancer.
•	Used to treat Graves' disease (a thyroid condition), this isotope concentrates in the thyroid and destroys the diseased portion. It is also used to treat thyroid cancer.
•	This isotope treats cervical cancer.
•	This isotope treats bone pain.

## 3. Agriculture

Isotope	Use
• • •	These three isotopes help farmers determine the amount of nutrients and water that plants take from the soil. This information gives farmers a better indication of how much fertilizer and water they should use to avoid excess. It helps them to protect the environment from runoff, to preserve the water supply, and to save money.
<b>Other Uses of Isotopes in Agriculture</b>	
<ul style="list-style-type: none"> <li>• To breed disease-resistant livestock, scientists use radioactive material to pinpoint where illnesses strike animals.</li> <li>• Scientists use isotopes to control pests. Small levels of radiation sterilize disease-laden insects and pests, replacing the undesirable use of pesticides.</li> <li>• Isotopes are used to develop new strains of virus-resistant plants.</li> </ul>	

Appendix 3.4: The Importance and Application of Isotopes (*continued*)

## 4. Science

Isotope	Use
•	This isotope links birds and butterflies to their breeding and moulting areas. It enters feather and wing tissue (where the feathers are grown or the wing tissue is developed) as a result of the water that the organisms drink and the plants they eat. Concentrations of this isotope are higher in organisms from southeast regions of North America, and lower in the northwest regions. When water evaporates at the equator, the water with this isotope evaporates faster because it is heavier.
•	An isotope of this element was used to find a possible explanation of why some mallard ducklings born and raised in agricultural areas cannot fly.
• •	Criminal investigators use the ratio of these two isotopes in hair, tissues, and fluids to determine where people have lived.
•	This isotope measures the silicon uptake by ocean phytoplankton in order to monitor possible trends in global warming.
• •	One of these isotopes is given intravenously to a patient, and the other is ingested. The isotope given intravenously passes quickly through the body, while the ingested one must be metabolized. The ratio between the two isotopes indicates how long calcium is retained in the body before it is eliminated.
• •	These two isotopes are used to date objects such as rocks. They can be used to date objects up to $4.5 \times 10^9$ years old.
•	This isotope is used to study the effects of acid rain. Its path to waterways can be modelled using the isotope as a tracer. It is also being used to see whether there is a relationship between aluminum and Alzheimer's disease.
• •	The ratio between these two isotopes is used to indicate global temperatures. Rain near the tropical ocean has more of the heavier isotope, while precipitation near the poles has more of the lighter isotope. During ice ages, more of the lighter isotope is locked into polar ice, and rain everywhere on the planet has a higher concentration of the heavier isotope.
•	Large quantities of this isotope are required for nuclear weapons and nuclear reactions. It is also burned in brown dwarfs (failed stars).



## Appendix 3.4: The Importance and Application of Isotopes (continued)

## 5. Industry and Business

Isotope	Use
•	This isotope tracks leakage in buried sections of pipe.
•	This isotope gauges the moisture content of the soil at road- and building-construction sites.
• •	These two isotopes determine the efficiency of filtration systems.
•	This isotope is used to identify when mixing is complete in molten liquids. This ensures maximum strength for alloys.
• • •	These three isotopes are used to recognize welding defects in pipelines, boilers, and aircraft parts. The radiation is passed through the object, striking photographic film on the other side. The greater the number of cracks, breaks, or flaws in the object, the more radiation is recorded on the film.
•	This isotope is used in industrial devices to eliminate static electricity. It is also used to treat bottles before they are filled and to reduce static charge in the production of photographic film.
•	Museums rely on this radioactive material to verify the authenticity of paintings and art objects, while archeologists use it to determine the age of bones.
• •	These two isotopes can be used to detect explosives.
•	This isotope provides National Aeronautics and Space Administration (NASA) spacecraft with power.
•	This isotope is a fuel for nuclear power plants.
•	This isotope monitors paper thickness. If too few particles of this isotope pass through to the detector, the paper is too thick. If too many particles pass through, the paper is too thin.

(continued)

Appendix 3.4: The Importance and Application of Isotopes (*continued*)5. Industry and Business (*continued*)

Isotope	Use
<ul style="list-style-type: none"> <li>•</li> <li>•</li> </ul>	<p>Food is exposed to either of these two isotopes for 15 to 45 minutes in order to kill bacteria and parasites that can cause disease. (<b>Note:</b> This does not make the food radioactive.) This exposure reduces spoilage and increases the shelf life of foods in areas without refrigeration. While the process reduces levels of vitamin A, vitamin C, vitamin E, and thiamine, the levels are not reduced as much as when foods are cooked, canned, or frozen.</p> <p>The same isotopes are used to sterilize cosmetics, hair products, medical devices, bandages, condoms, tampons, and contact-lens solutions.</p>
<ul style="list-style-type: none"> <li>•</li> </ul>	<p>This isotope is used to date vintage wines.</p>
<p><b>Other Uses of Isotopes in Industry and Business</b></p> <ul style="list-style-type: none"> <li>• Some isotopes can determine the flow rates of piping systems.</li> <li>• The automobile industry uses isotopes to measure the rate of engine wear and the quality of steel used to make cars.</li> <li>• Manufacturers use isotopes to monitor the corrosion of their processing equipment.</li> <li>• Isotopes are used to identify the densities of various materials.</li> <li>• The proper thickness of aluminum and tin cans can be maintained with the help of isotopes.</li> <li>• Some isotopes are used to identify the geological structure of a site. This would show the likelihood of finding oil, natural gas, or minerals.</li> <li>• Isotopes used in photocopiers help eliminate static and prevent papers from sticking together.</li> </ul>	

## Appendix 3.4: The Importance and Application of Isotopes (continued)

## 6. Consumer Products and Services

Isotope	Use
•	Smoke detectors rely on this radioactive source to sound an alarm when sensing smoke from a fire. This isotope emits particles that ionize the air particles around the alarm. These charged air molecules conduct electricity so that current flows through the device. Smoke will interrupt the flow of electricity and set off the alarm.
•	This gas can extend the life of a computer chip eight times longer than a chip created with hydrogen gas.
•	This isotope is used in indicator lights in washing machines, dryers, stereos, and coffee makers.
• •	These two isotopes act as voltage regulators and current surge protectors.
•	This isotope is used in electric blanket thermostats.
•	This isotope prolongs the life of fluorescent lights.
•	Together with minute amounts of phosphor, this isotope creates the luminescence that is used for emergency lighting, self-luminous aircraft, exit signs, and luminous dials, gauges, watches, and paint. Because no electricity is required, emergency lighting can be provided where sparks can be dangerous or where no wiring exists.
•	This isotope is used in dental fixtures (i.e., crowns and dentures) to provide natural colour and brightness.
•	This isotope powers pacemakers, reducing the risk of repeated surgery.
<p><b>Other Uses of Isotopes in Consumer Products and Services</b></p> <ul style="list-style-type: none"> <li>• Computer disks remember data better when they are treated with isotopes.</li> <li>• Non-stick pans are treated with isotopes so that the coating sticks to the surface better.</li> </ul>	

---

**Appendix 3.4: The Importance and Application of Isotopes (continued)**

---

**Answer Key****1. Medical Diagnosis**

- Oxygen-15/Fluorine-18
- Iodine-131
- Sodium-24
- Rubidium-82
- Technetium-99m
- Carbon-13

**2. Medical Treatment**

- Bismuth-213
- Gold-198
- Cobalt-60
- Iodine-125
- Iodine-131
- Californium-252
- Rhenium-188

**3. Agriculture**

- Phosphorus-32/Nitrogen-15/  
Carbon-14

**4. Science**

- Deuterium (Hydrogen-2)
- Nitrogen-14
- Oxygen-18/Deuterium  
(Hydrogen-2)
- Silicon-32
- Calcium-42/Calcium-44
- Uranium-238/Lead-206
- Aluminium-26
- Oxygen-16/Oxygen-18
- Deuterium (Hydrogen-2)

**5. Industry and Business**

- Iodine-131
- Californium-252
- Deuterium (Hydrogen-2)/Oxygen-18
- Vanadium-52
- Iridium-192/Sodium-24/Cobalt-60
- Polonium-210
- Carbon-14
- Nickel-62/Californium-252
- Plutonium-238
- Uranium-238
- Strontium-90
- Cobalt-60/Cesium-137
- Tritium (Hydrogen-3)

**6. Consumer Products and Services**

- Americium-241
- Deuterium (Hydrogen-2)
- Krypton-85
- Nickel-62/Californium-252
- Promethium-147
- Thorium-229
- Tritium (Hydrogen-3)
- Uranium-238
- Plutonium-238

**Appendix 3.5: Names, Formulas, and Charges of Some Common Ions**

Positive Ions		Negative Ions	
Ammonium	$\text{NH}_4^+$	Acetate, Ethanoate	$\text{CH}_3\text{COO}^-$
Cadmium	$\text{Cd}^{2+}$	Arsenate	$\text{AsO}_4^-$
Chromium(II)	$\text{Cr}^{2+}$	Bromate	$\text{BrO}_3^-$
Chromium(III)	$\text{Cr}^{3+}$	Carbonate	$\text{CO}_3^{2-}$
Cobalt(II)	$\text{Co}^{2+}$	Hydrogen Carbonate, Bicarbonate	$\text{HCO}_3^-$
Cobalt(III)	$\text{Co}^{3+}$	Chlorate	$\text{ClO}_3^-$
Copper(I)	$\text{Cu}^+$	Chlorite	$\text{ClO}_2^-$
Copper(II)	$\text{Cu}^{2+}$	Chromate	$\text{CrO}_4^{2-}$
Hydrogen, Hydronium	$\text{H}^+, \text{H}_3\text{O}^+$	Cyanide	$\text{CN}^-$
Iron(II)	$\text{Fe}^{2+}$	Dichromate	$\text{Cr}_2\text{O}_7^{2-}$
Iron(III)	$\text{Fe}^{3+}$	Hydride	$\text{H}^-$
Lead(II)	$\text{Pb}^{2+}$	Hydroxide	$\text{OH}^-$
Lead(IV)	$\text{Pb}^{4+}$	Hypochlorite	$\text{ClO}^-$
Manganese(II)	$\text{Mn}^{2+}$	Iodate	$\text{IO}_3^-$
Manganese(III)	$\text{Mn}^{3+}$	Nitrate	$\text{NO}_3^-$
Mercury(I)	$\text{Hg}_2^{2+}$	Nitrite	$\text{NO}_2^-$
Mercury(II)	$\text{Hg}^{2+}$	Oxalate	$\text{C}_2\text{O}_4^{2-}$
Nickel	$\text{Ni}^{2+}$	Oxide	$\text{O}^{2-}$
Scandium	$\text{Sc}^{3+}$	Perchlorate	$\text{ClO}_4^{1-}$
Silver	$\text{Ag}^+$	Permanganate	$\text{MnO}_4^-$
Tin(II)	$\text{Sn}^{2+}$	Phosphate	$\text{PO}_4^{3-}$
Tin(IV)	$\text{Sn}^{4+}$	Phosphite	$\text{PO}_3^{3-}$
Zinc	$\text{Zn}^{2+}$	Monohydrogen Phosphate	$\text{HPO}_4^{2-}$
		Dihydrogen Phosphate	$\text{H}_2\text{PO}_4^-$
		Sulphate	$\text{SO}_4^{2-}$
		Hydrogen Sulphate, Bisulphate	$\text{HSO}_4^-$
		Sulphite	$\text{SO}_3^{2-}$
		Hydrogen Sulphite, Bisulphite	$\text{HSO}_3^-$
		Hydrogen Sulphide, Bisulphide	$\text{HS}^-$

**Appendix 3.6: Ionic Name Game**

1. Remove one positive ion (blue piece of paper) and one negative ion (yellow piece of paper) from the container presented by your teacher.
2. List the cation and anion in the appropriate columns of the table below.
3. Use this information to determine the formula and the name of the ionic compound formed when these two ions combine.
4. List the formula and the name in the table.
5. Return the cation and anion to the bowl, mix the papers, and repeat steps 1 through 4 until you have named 12 different ionic compounds.

<b>Positive Ion (Cation)</b>	<b>Negative Ion (Anion)</b>	<b>Formula of the Compound</b>	<b>Name of the Compound</b>

## Appendix 3.7: Stoichiometry: The Formula of a Precipitate (Student Experiment)

---

### Problem

What is the formula of cobalt hydroxide?

### Materials

- well plate
- ruler
- 2 polyethylene pipettes
- 13 culture tubes (6 x 50 mm)
- toothpick (or sealed capillary tube)

### Aqueous Solutions

- cobalt(II) chloride,  $\text{CoCl}_2$ , 0.0159 g/mL
- sodium hydroxide,  $\text{NaOH}$ , 0.0160 g/mL

### Safety Precautions

- Sodium hydroxide is caustic and corrosive. Use caution and wash any spills with plenty of water.
- Cobalt compounds are toxic; do not ingest. Wash hands thoroughly before leaving the laboratory. See Material Safety Data Sheet.

### Procedure

1. Place the 13 small culture tubes (test tubes) in the wells of the well plate.
2. Add 24 drops of the cobalt(II) chloride solution to the 1st test tube. Add 22 drops of cobalt(II) chloride solution to the 2nd test tube. Continue to decrease the number of drops by 2 until you have placed 2 drops in the 11th test tube. The 12th test tube remains empty; it acts as a control. Check test tubes 1 through 11 to see whether each successive test tube has decreased by the same amount – it should look like a staircase. If one or more tubes seem to have too little or too much, adjust accordingly by adding or withdrawing some cobalt(II) chloride solution.
3. Repeat this procedure with the sodium hydroxide solution, but start in the reverse order (i.e., add 24 drops of sodium hydroxide solution to the 12th test tube, 22 drops to the 11th tube, and so on). The 1st test tube will have no sodium hydroxide solution added; it also acts as a control. The total volume in every test tube should be the same.
4. Using a toothpick or a sealed capillary tube, stir the solutions with an up-and-down motion. This helps the precipitate settle to the bottom of the test tube.
5. Allow the test tubes to sit undisturbed in the well plate for 10 minutes.
6. Take each test tube out of the well plate in turn, and measure the height of the precipitate in the test tube.

---

**Appendix 3.7: Stoichiometry: The Formula of a Precipitate**  
(Student Experiment) *(continued)*

---

7. Record your results in a table similar to the one below.

Test Tube	Drops of $\text{CoCl}_{2(\text{aq})}$	Drops of $\text{NaOH}_{(\text{aq})}$	$\frac{\text{Drops of CoCl}_{2(\text{aq})}}{\text{Drops of NaOH}_{(\text{aq})}}$	Height of Precipitate
#1	24	0	...	0
#2	22	2	11	...
#3	20	4	5	...

8. Transfer the contents from all the test tubes to the appropriate waste container.

**Conclusion**

1. What can you conclude from this experiment?

2. What is the mass to volume ratio of the precipitate?

**Follow-up Questions**

1. What is the significance of measuring the volume?
2. How could you relate the volume measured to the mass of the reacting substances?
3. What is the significance of measuring the height? What does the height represent (approximately), or what is the height proportional to?



## Appendix 3.7: Stoichiometry: The Formula of a Precipitate (Discussion/Extensions—Teacher Notes)

### Safety Precautions

- Lead and cobalt compounds are toxic and accumulate in body tissues. Wear gloves when preparing these solutions.

### Alternatives

- This experiment could be done with solutions of
  - lead(II) nitrate,  $\text{Pb}(\text{NO}_3)_2$ , and potassium iodide, KI
  - calcium nitrate,  $\text{Ca}(\text{NO}_3)_2$ , and sodium oxalate,  $\text{Na}_2\text{C}_2\text{O}_4$
- Use only freshly distilled or boiled distilled water to make up these solutions, as dissolved carbon dioxide interferes with the results.

### Disposal

Cobalt compounds are toxic. Collect all waste material in a waste container specified for this experiment. Acidify the solution with a minimum amount of 6.0 mol/L hydrochloric acid, and then precipitate out cobalt(II) sulphide by adding 3.0 mol/L solution of sodium sulphide. Allow the precipitate to settle. Decant the excess solution and flush it down the drain with excess water. Allow the precipitate to dry and arrange to have it disposed of in an appropriate manner.

The lead iodide formed must also be disposed of carefully. Collect all waste material in a waste container specified for this experiment. It should be converted into its most insoluble form. Then arrange to have it buried at an approved hazardous waste landfill site. Any waste solution should be treated with a *threefold* excess of sodium sulphide or thioacetamide and stirred occasionally for about one hour. Adjust the pH to neutral with 3 M sodium hydroxide, NaOH, solution to complete the precipitation of the lead compound. Separate the solid lead sulphide by filtration and allow it to dry. Place the lead sulphide in a plastic container of appropriate size, and have it buried at an appropriate landfill site. The filtrate should be added slowly with stirring to an excess of ferric chloride. A precipitate will form. Neutralize the remaining solution with sodium carbonate (some evolution of  $\text{CO}_2$  will occur). Allow the precipitate to settle. Flush the neutral solution down the drain with excess water. Allow the precipitate to dry and have it buried at an appropriate landfill site.

### Further Examination

Extend the experiment by showing which solutions have an excess of reagent. Have students remove a small amount of liquid from above the precipitate (supernatant liquid) in the 2nd test tube using a clean pipette, and transfer to either the well or another small test tube. Show that there is unreacted cobalt(II) chloride present by adding a drop or two of sodium hydroxide solution. Also, if an ammonium thiocyanate solution (5%  $\text{NH}_4\text{SCN}$ ) is added, the turquoise tetrahedral cobalt(II) tetrathiocyanato complex,  $\text{Co}(\text{SCN})_4^{2-}$ , should be observed.

### Appendix 3.7: Stoichiometry: The Formula of a Precipitate (Discussion/Extensions—Teacher Notes) (continued)

Similarly, you can show unreacted sodium hydroxide in solutions by adding a drop or two of cobalt(II) chloride solution or a few drops of phenolphthalein indicator solution to a sample of the supernatant liquid.

#### Stoichiometry: Concept Extensions

A. By reacting solutions with a variety of known proportions of two substances, we can find the proportion giving the greatest amount of precipitate, and thereby determine the definite proportion for the two substances in that compound. Another way to determine the definite proportion of two substances reacting is to vary the proportion of two substances, and measure the amount of heat given off. The correct proportion will give off the most heat.

1. Prepare a solution of 0.50 M sodium hypochlorite (NaOCl, the active ingredient in bleach), and a solution of 0.50 M sodium thiosulphate ( $\text{Na}_2\text{S}_2\text{O}_3$ , the substance that photographers call “fixer”).
2. Measure increasing quantities of NaOCl (see the following chart) into a foam cup. Measure decreasing quantities of  $\text{Na}_2\text{S}_2\text{O}_3$  (see the following chart) into a beaker. Place a thermometer (with 1/10 degree graduations) in the foam cup. Pour the solution from the beaker into the cup and swirl it for two seconds. Immediately note the temperature and record the highest temperature reached after the solutions have been mixed.

Station #	NaOCl (mL)	$\text{Na}_2\text{S}_2\text{O}_3$ (mL)	Starting Temperature (°C)	Highest Temperature (°C)
1	10	90		
2	20	80		
3	30	70		
4	40	60		
5	50	50		
6	60	40		
7	70	30		
8	80	20		
9	90	10		

3. Ask students to analyze the data in the table to determine the definite proportions for these two substances. (The proportion of solutions producing the largest change in temperature is the correct proportion of the two compounds needed to react and form the product.)

**Appendix 3.7: Stoichiometry: The Formula of a Precipitate**  
**(Discussion/Extensions—Teacher Notes) (continued)**

---

- B. An important chemical principle is the Law of Definite Proportions, which states that compounds will always have the same proportion of elements by mass regardless of where or how the compounds were formed. In other words, water has the same proportion of oxygen and hydrogen in Russia, Canada, and Africa. Furthermore, the active ingredient or compound in different brands will have the same proportion of elements in the compound no matter where they were produced.

Epsom salts is the common name for magnesium sulphate heptahydrate. If some Epsom salts are heated, water is given off. If all brands of Epsom salts have the same proportion of water, we should be able to verify this experimentally using the Law of Conservation of Mass.

1. Purchase three different brands of Epsom salts. Most pharmacies have their own generic brand. Mass different amounts of the three brands and assign them to different groups.
2. Place the Epsom salts into a large test tube and heat slowly but thoroughly for about 10 to 15 minutes to drive off the water. A Bunsen burner or other heat source could be used (e.g., Epsom salts can also be heated in an oven for a few hours at about 350°F [176°C].)
3. It is important to drive off all the water, regardless of the heating method used. If the Bunsen burner is used, weigh the test tube before and after the initial heating and again after each subsequent heating until two subsequent weights are within 0.2 g. Allow the test tube to cool to room temperature before weighing. If the oven is used, a second heating of about 30 minutes is needed to ensure that all the water has been driven off.
4. Ask groups to determine the percentage of water in each brand of Epsom salt using class results.

### Appendix 3.7: Stoichiometry: The Formula of a Precipitate (Discussion/Extensions—Teacher Notes) (continued)

C. The table below presents some typical results using the method described in Experiment 14 in *Microscale Chemistry Laboratory Manual* (Slater and Rayner-Canham 39). An attempt was made to speed up the procedure by rinsing the copper metal with five small portions of propanone (acetone) using filter paper and a funnel. The propanone was allowed to drain thoroughly between rinses. The filter paper was then removed from the funnel and allowed to air-dry 15 minutes before weighing. While these results are reasonable, better results can be obtained by allowing the sample to dry overnight.

Take the opportunity to emphasize the importance of observation and interpretation in all experiments. Students might need to be led with questions such as these:

- What is the colour of copper(II) sulphate?
- What is the colour of the mixture of copper(II) sulphate and water?
- What does iron powder look like?
- What colour is the solid that you filtered? What does this tell you?
- What colour is the liquid that you filtered off? What does this mean?

Typical Results for Stoichiometric Reaction Producing a Solid					
Trial	Mass $\text{CuSO}_4 \cdot 5\text{H}_2\text{O}$	Mass Fe	Mass Cu	$\frac{\text{Mass Cu}}{\text{Mass Fe}}$	Comments
1	0.569 g	0.107 g	0.127 g	1.19	after drying overnight
2	0.954 g	0.131 g	0.162 g	1.24	washed with acetone; dried 15 minutes
	0.954 g	0.131 g	0.154 g	1.18	after drying overnight
3	1.490 g	0.329 g	0.417 g	1.27	washed with acetone; dried 15 minutes
	1.490 g	0.329 g	0.327 g	1.13	after drying overnight

The graph of mass of copper versus mass of iron obtained from these results is given below. The line represents the theoretical line for a 1:1 stoichiometry – i.e., for the displacement reaction:

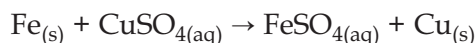

Obviously any soluble copper compound could be used in place of copper(II) sulphate pentahydrate. Other 1:1 stoichiometric ratio combinations that work well include iron metal and any soluble tin(II) compound (e.g., tin(II) chloride) or zinc metal with any soluble lead(II) or copper(II) compound. A stoichiometric ratio of 1:2 can be demonstrated using copper metal with silver(I) nitrate.

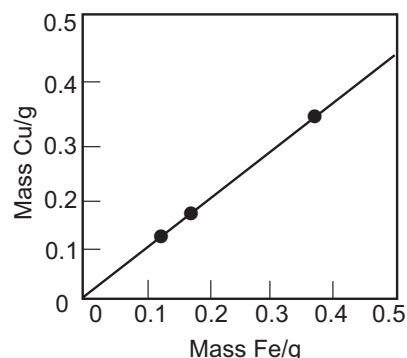

**Appendix 3.8: Indications of Chemical Reactions (Student Experiment)**

---

**Problem**

Identify the characteristics that indicate the occurrence of a chemical reaction.

**Equipment**

- small (13 x 100 mm) test tubes
- medium (18 x 150 mm) test tubes
- medium (250 mL) beakers
- glass stirring rods
- medicine droppers
- wood splints

**Materials**

- *Liquids*
  - ethanol,  $C_2H_5OH$
  - phenolphthalein, 0.4% aqueous solution
  - sulphuric acid,  $H_2SO_4$ , concentrated
- *Solids*
  - sugar crystals
  - zinc, Zn, powder
  - potassium permanganate,  $KMnO_4$
  - diiodine (iodine),  $I_2$ , crystals,
  - calcium carbide,  $CaC_2$
  - sodium thiosulphate,  $Na_2S_2O_3$
- *Aqueous Solutions, 1.0 mol/L*
  - lead nitrate,  $Pb(NO_3)_2$
  - hydrogen chloride,  $HCl_{(aq)}$
  - potassium chromate,  $K_2CrO_4$
  - potassium iodide, KI
  - sodium sulphide,  $Na_2S$
  - sodium hydroxide, NaOH
  - potassium dichromate,  $K_2Cr_2O_7$

---

**Appendix 3.8: Indications of Chemical Reactions (Student Experiment) (continued)**

---

**Safety Precautions**

- Potentially toxic fumes may be liberated in the reaction of sugar with concentrated sulphuric acid. Perform the demonstration in a properly functioning fume hood.
- Sulphuric acid,  $\text{H}_2\text{SO}_4$ , is corrosive to skin and can cause serious eye damage. Wear eye protection at all times. If you get any solution on your skin or eyes, wash immediately with water for a minimum of 15 minutes.
- See the Material Safety Data Sheet before the lab demonstration/activity begins.

**Procedure****Part A: Demonstration (Teacher Only)**

1. Mix a small amount of potassium permanganate,  $\text{KMnO}_4$ , with a few drops of sulphuric acid,  $\text{H}_2\text{SO}_4$ . Use a glass stirring rod to mix the chemicals. Then touch the end of the rod used for mixing to some alcohol in an evaporating dish. Ask students to record their observations.

**Part B: Student Experiments**

1. Record all observations using a data sheet similar to the one that follows. Discard the resulting mixtures in the proper containers after each experiment.
2. Fill a medium test tube 1/4 full with sugar. Place the test tube in a beaker. Add 2 full droppers of sulphuric acid,  $\text{H}_2\text{SO}_4$ . **Caution:** Perform in a fume hood.
3. Fill a small test tube 1/4 full with aqueous sodium sulphide solution,  $\text{Na}_2\text{S}$ . Add 2 drops of lead nitrate solution,  $\text{Pb}(\text{NO}_3)_2$ .
4. Fill a small test tube 1/4 full with potassium iodide solution (KI). Add 2 drops of lead nitrate solution,  $\text{Pb}(\text{NO}_3)_2$ .
5. Mix 1/8 spoonful of zinc (Zn) with 1/8 spoonful of diiodine ( $\text{I}_2$ ) in a small DRY test tube. Shake lightly to mix. Place the test tube in a beaker. Add 3 drops of water. **Caution:** Perform in a fume hood.
6. a) Fill a medium test tube 1/2 full with water. Place the test tube in a beaker, and add a pea-size piece of calcium carbide,  $\text{CaC}_2$ .  
b) Quickly light the gas evolved with a burning splint.
7. Fill a small test tube 1/4 full with hydrogen chloride solution,  $\text{HCl}_{(\text{aq})}$ . Add 3 drops of the phenolphthalein indicator solution. With a dropper, slowly add aqueous sodium hydroxide,  $\text{NaOH}_{(\text{aq})}$ .
8. Fill a medium test tube 1/3 full with water. Dissolve 1/4 spoonful of sodium thiosulphate,  $\text{Na}_2\text{S}_2\text{O}_3$ , in the water. Does the tube feel warmer or colder than it did before the sodium thiosulphate was added? Note the temperature change.

## Appendix 3.8: Indications of Chemical Reactions (Student Experiment) (continued)

9. a) Add a few drops of hydrogen chloride solution,  $\text{HCl}_{(\text{aq})}$ , to 1/8 test tube aqueous potassium chromate solution,  $\text{K}_2\text{CrO}_4$ .
- b) Add a few drops of hydrogen chloride solution,  $\text{HCl}_{(\text{aq})}$ , to 1/8 test tube aqueous potassium dichromate solution,  $\text{K}_2\text{Cr}_2\text{O}_7$ .
- c) Add a few drops of aqueous NaOH to 1/8 test tube aqueous potassium chromate solution,  $\text{K}_2\text{CrO}_4$ .
- d) Add a few drops of aqueous NaOH to 1/8 test tube aqueous potassium dichromate solution,  $\text{K}_2\text{Cr}_2\text{O}_7$ .

Indications of Chemical Reactions—Data Sheet		
Experiment	Observations	Chemical Reaction (Equation)
1		
2		
3		
4		
5		
6		
7		
8		
9		

**Question**

1. List four characteristics or indicators of a chemical reaction.

## Appendix 3.8: Indications of Chemical Reactions (Alternate): Chemistry in a Bag (Student Experiment)

### Problem

To identify characteristics of a chemical reaction.

### Materials

- a dilute phenolphthalein solution made by adding 3 drops of phenolphthalein to 30 mL water
- 10 g sodium bicarbonate,  $\text{NaHCO}_3$
- 7 g calcium chloride,  $\text{CaCl}_2$
- paper cups
- resealable plastic bag (e.g., plastic zippered bag)

### Procedure

**Caution:** Goggles must be worn!

1. Carefully measure the proper amounts of sodium bicarbonate and calcium chloride in separate paper cups or weigh boats.
2. Carefully pour the samples into opposite corners of the bottom of a resealable bag.

**Note:** Do not mix the chemicals at this point!

3. Lay the bag carefully on its side on a lab bench. Gently pour in the phenolphthalein solution and, without picking up the bag, seal it. Push the solution from the centre of the bag outwards to the opposite corners with your fingers, pressing from the outside of the bag. Make note of any changes in the appearance of the chemicals in each corner as the solution makes contact. Touch the bag at each corner and make note of any temperature changes.
4. Swish the bag gently to mix all the contents, and again make observations as to any changes you see, hear, or feel.

### Questions

1. What changes took place when the sodium bicarbonate came into contact with the phenolphthalein solution?
2. What changes took place when the calcium chloride came into contact with the phenolphthalein solution?
3. What changes took place when all three substances were mixed together?
4. From these observations, list three characteristics of a chemical reaction.
  - a) \_\_\_\_\_
  - b) \_\_\_\_\_
  - c) \_\_\_\_\_
5. Do you think that the mass of the bag and contents changed as a result of this chemical reaction? How could you check?



## Appendix 3.8: Indications of Chemical Reactions (Discussion— Teacher Notes)

---

### Safety Precautions

- The reaction of sugar with sulphuric acid is hazardous! Concentrated sulphuric acid is very corrosive.
- Spills must immediately be neutralized with sodium bicarbonate, and diluted with copious amounts of water.
- Spills on skin or clothing should be immediately bathed in water for a minimum of 5 minutes.
- Spills in the eyes should immediately be rinsed with water for a minimum of 15 minutes.
- Further medical attention should be sought for spills on skin or eyes.
- See Material Safety Data Sheets.

### Reaction of Sugar with Sulphuric Acid

The reaction of sugar with concentrated sulphuric acid is quite slow to begin, but will eventually be vigorous, with copious amounts of steam and a rapidly growing column of black carbon. The best results for this experiment have been obtained in a large (20 x 200 mm) test tube containing about 10 mL of sugar and 7 mL of water, to which is added 10 mL of concentrated sulphuric acid. Even half these quantities will yield a sufficient reaction. The major cause of foaming is the production of steam.

Concentrated sulphuric acid is a very powerful dehydrating agent, as is shown by this demonstration.

The sulphuric acid removes water from sugar. The reaction may be represented by the equation:

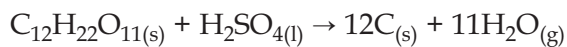

However, the reaction is more complex. More than 50% of the gas evolved is carbon monoxide. Other products include sulphur dioxide, carbon dioxide, and other carbon-containing compounds.

### Disposal Procedures

- Dispose of the carbon “sausage” and test tube carefully. The unreacted sulphuric acid should be neutralized with sodium bicarbonate and washed with water before disposing of the carbon “sausage” in the waste.
- Solutions or precipitates containing lead or chromium should be carefully collected and disposed of in a secure landfill site specifically designed for such hazardous wastes.
- The solutions of acids or bases should be neutralized before being flushed down the drain. Solutions of sodium thiosulphate (hypo) can also be flushed down the drain.

## Appendix 3.9: Determining the Molar Mass of a Gas (Student Experiment)

### Purpose

The molar mass of a compound is an important constant that, in some cases, can help identify a substance. In this lab, you will calculate the molar mass of butane using calculations involving the combined gas law and the constant 22.4 L/mole.

### Materials

- goggles
- butane lighter (with flint removed)
- plastic bucket
- water
- graduated cylinder (1000 mL)
- funnel
- balance
- thermometer
- barometer

### Procedure

1. Determine the initial mass of the butane lighter.
2. Pour water into the bucket until it is about three-quarters full. Then fill the graduated cylinder with water and invert it into the bucket so that the water level is within the calibrated region. Record the volume reading.
3. Place the funnel in the mouth of the graduated cylinder while it is under the water to ensure all butane gas bubbles are collected.
4. Hold the butane lighter in the water under the graduated cylinder and funnel apparatus. Release the butane gas from the lighter into the mouth of the graduated cylinder until you have displaced from half to three-quarters of the water within the cylinder.
5. Equalize the pressures inside and outside the cylinder by adjusting the position of the cylinder until the water levels inside and outside the cylinder are the same.
6. Read the measurement on the cylinder and record the volume of gas collected.
7. Record the ambient (room) temperature and pressure.
8. Thoroughly dry the butane lighter and determine its final mass.

## Appendix 3.9: Determining the Molar Mass of a Gas (Student Experiment) (continued)

## Observations

Data Chart	
Initial mass of lighter	
Final mass of lighter	
Mass of gas released	
Initial volume reading on graduated cylinder	
Final volume reading on graduated cylinder	
Volume of gas released	
Room temperature	
Room air pressure	

## Calculations

1. Using the combined gas law, convert the volume of gas released in the lab to the volume it would occupy at standard temperature and pressure (STP).
2. Use the volume of gas at STP (recorded above) and the gas constant of 22.4 L/mole to determine the number of moles of gas collected at STP.
3. Use the mass of gas released (from the data chart) and divide it by the moles of gas at STP to find the molar mass of the gas.

## Conclusions

1. What is the molar mass of the butane according to your lab results?
2. What is the known molar mass of butane according to the periodic table?
3. What is your experimental percent error?
4. Every experiment has some experimental error or uncertainties. State some possible flaws, limitations, experimental errors, or uncertainties that may affect the accuracy of your results. Make a list and rank them from most to least significant.
5. It is always possible to omit a source of experimental error. In the experiment, you may not have realized that butane in a lighter is not pure butane but contains a small quantity of water vapour. For a typical room temperature, this would correspond to about 2.6 kPa of the pressure you recorded. Subtract this value from the pressure you used, and use the new pressure to recalculate the molar mass and the experimental percent error. Is your answer significantly more accurate? Explain.

## Appendix 3.9: Determining the Molar Mass of a Gas (Teacher Notes)

### Safety Precautions

- Butane is highly flammable.
- Do not conduct this experiment near an open flame.
- Good ventilation in the laboratory is essential.
- Eye protection is required.
- Flints must be removed from the butane lighters. You can pry off the metal casing (hood) and the spark wheel of the typical disposable commercial lighter without much effort, and the flint and a long spring will just pop out.

### Important Notes

- You will need one butane lighter per group.
- An ice cream pail (4 L) works fine for this experiment, but because it is small it is a little clumsy to use. The funnel could be removed so that you have more hand room, but then students have to be more careful not to lose the bubbles. A sink filled with water works well also.
- If you don't have a barometer, you can find the air pressure for your town or city on a weather website on the Internet.
- After thoroughly drying the lighter, you may also want to let it air dry for a while so that the interior parts can dry as well. A more accurate mass can be recorded after this is done.

### Observations

Sample Data Chart	
Initial mass of lighter	18.17 g
Final mass of lighter	18.01 g
Mass of gas released	0.16 g
Initial volume reading on graduated cylinder	21.0 mL
Final volume reading on graduated cylinder	89.8 mL
Volume of gas released	68.8 mL
Room temperature	22°C = 295 K
Room air pressure	102.14 kPa

Appendix 3.9: Determining the Molar Mass of a Gas (Teacher Notes) *(continued)*

---

**Calculations**

$$1. \quad \frac{P_1 V_1}{T_1} = \frac{P_2 V_2}{T_2}$$
$$\frac{(102.14)(68.8)}{295} = \frac{(101.3)(V_2)}{273} = 64.2 \text{ mL}$$

2. Since one mole of butane occupies a volume of 22.4 L at STP, then  $0.0642/22.4 = 0.00287$  moles of gas is collected.
3. Since 0.00287 moles of butane gas has a mass of 0.16 grams, then  $0.16/0.00287 = 55.8$  g is the molar mass of butane based on our experimental data.

**Conclusions**

1. 55.8 g/mole
2. 58.1 g/mole
3.  $\frac{\text{absolute difference between experimental and theoretical value}}{\text{theoretical value}} \times 100$

$$\frac{(58.1 - 55.8)}{58.1} \times 100 = 4.0\%$$

4. Answers may vary, but could include:
  - massing of butane lighter after the lab when it still had traces of water
  - losing some bubbles of butane out of the graduated cylinder
5. The answer is more accurate; therefore, this unknown source of error was significant.

## Appendix 3.10: Gas Density Table (Student Resource Material)

### Density of Gases at 25°C and 101.3 kPa (760 mmHg or 1.0 atm) Pressure

Name	Formula	Molar Mass (g/mol)	Density (g/L)
Ammonia	NH <sub>3</sub>	17.03	0.696
Argon	Ar	39.944	1.633
Butane	C <sub>4</sub> H <sub>10</sub>	58.12	2.376
Carbon dioxide	CO <sub>2</sub>	44.01	1.799
Carbon monoxide	CO	28.01	1.145
Dichlorine	Cl <sub>2</sub>	70.91	2.898
Ethane	C <sub>2</sub> H <sub>6</sub>	30.07	1.229
Ethene	C <sub>2</sub> H <sub>4</sub>	28.05	1.147
Ethyne (acetylene)	C <sub>2</sub> H <sub>2</sub>	26.04	1.064
Helium	He	4.003	0.164
Dihydrogen	H <sub>2</sub>	2.016	0.082
Hydrogen chloride	HCl	36.47	1.490
Hydrogen iodide	HI	127.93	5.228
Krypton	Kr	83.70	3.425
Methane	CH <sub>4</sub>	16.04	0.656
Neon	Ne	20.18	0.825
Nitrogen monoxide	NO	30.01	1.226
Dinitrogen	N <sub>2</sub>	28.02	1.145
Dinitrogen monoxide	N <sub>2</sub> O	44.02	1.799
Nitrogen dioxide	NO <sub>2</sub>	46.01	1.880
Dioxygen	O <sub>2</sub>	32.00	1.308
Ozone	O <sub>3</sub>	48.00	1.962
Propane	C <sub>3</sub> H <sub>8</sub>	44.09	1.802
Sulphur dioxide	SO <sub>2</sub>	64.07	2.618
Xenon	Xe	131.30	5.367

## Appendix 3.11: Creative Mole: Writing Activity

You have just been introduced to the concept of *mole*. It is a relatively abstract concept, as it is difficult to picture  $6.02 \times 10^{23}$  particles of anything. This creative writing assignment will let you explore this topic and become more comfortable with the new vocabulary.

The assignment will be done in the form of a RAFT:\*

- R** → **Role of writer:** Who are you?  
**A** → **Audience:** To whom are you writing?  
**F** → **Format:** What form will you use? (e.g., letter, rap song, poem, advertisement)  
**T** → **Topic and strong verb:** What important topic have you chosen? What strong verb describes your intent? (e.g., to persuade, demand, plead)

Below is a list of possible ideas for your RAFT writing activity. You may use one of these ideas, or you may choose one of your own. If you choose your own idea, please discuss it with the teacher before you start writing.

Role	Audience	Format	Topic
Atom of lead (Pb)	Other lead atoms	Want ad	Convince others to join you in a heavy metal mole band.
Pile of salt	Other formula units	News release	Announce the discovery of how many moles make up your pile.
Mole	Periodic table	Rap song	Explain how to find your molar mass.
Real estate agent	Mole of oxygen	Real estate ad	Sell the ideal home for a mole of oxygen.

Your goal is to show that you know how to convert between moles, volume, mass, and number of particles and that you understand the vocabulary.

### Assessment Criteria

- At least five new vocabulary words are used correctly/explained.
- Calculations are correctly described.
- The writing is interesting and creative.
- The writing is clear. Correct spelling and grammar are used.
- The assignment is sufficient in length (from half a page to a page).

\* **Reference:** Santa, C.M. *Context Reading Including Study Systems*. Dubuque, IA: Kendall Hunt, 1988.

## Appendix 3.12: The Stoichiometry of Gasoline: Internet Research Activity

### Instructions

Use the Internet and your knowledge of stoichiometry to answer the following questions. Fuel consumption ratings and CO<sub>2</sub> emissions data can be found at the following website.



Natural Resources Canada:

<<http://oee.nrcan.gc.ca/transportation/personal-vehicles-initiative.cfm>>

Click on the link that says “Fuel Consumption Ratings.”

1. The energy used to propel a vehicle comes from the combustion of gasoline, C<sub>8</sub>H<sub>18</sub>. Write a balanced chemical equation for the combustion of gasoline.
2. Most gas stations offer three different grades of gasoline: regular, mid-grade, and premium. What is the difference between these three types of gasoline?
3. Answer the remaining questions, using *three* of the following vehicles as your examples:

- 2007 Lexus SC400
- 2007 Ford X150 Pickup Truck
- 2007 Honda Civic Hybrid (Gas/electric)
- 2007 VW Jetta TDI Diesel
- 2007 Honda Odyssey Van

- a) Identify the size of the gas tank for each of the three selected vehicles.
- b) Determine the highway fuel economy for each of the three vehicles.
- c) Determine the cost of regular and premium gasoline. Use this information to calculate how much it would cost to fill the gas tank for each of the three vehicles. (Note that the Lexus requires premium gasoline.)
- d) If one litre of gasoline contains 6.18 moles of gas, how many moles of gas fit in the tank of each vehicle?
- e) What is the mass of a full tank for each vehicle?
- f) If you were to take each vehicle on a road trip, approximately how far could you drive if you began with a full tank of gas?
- g) If you were to use an entire tank of gas for each vehicle, how much carbon dioxide would be emitted?
  - How many *moles* of carbon dioxide would be emitted from each vehicle?
  - How many *grams* of carbon dioxide would be emitted from each vehicle?
  - How many *litres* of carbon dioxide would be emitted from each vehicle?



## Appendix 3.13: How to Solve a Limiting Reactant Problem

### Question

Roasting chalcocite (a copper sulphide) is the first step in extracting copper metal from this sulphide ore. Note that a precursor to sulphuric acid is one of the products of this “roasting of ore.” Think of the implications in the atmosphere when this product connects with water vapour in the air.

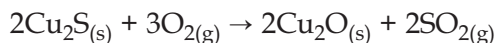

If 30.00 g of  $\text{Cu}_2\text{S}$  is reacted with 7.47 L of  $\text{O}_2$  at STP, what is the maximum mass of copper oxide produced?

### Solution

Reactant	Moles of Reactant	Moles Needed to React Completely	Type of Reagent
$\text{Cu}_2\text{S}$	$30.00 \text{ g} \times \frac{1 \text{ mol}}{159.16 \text{ g}}$ $= 0.1885 \text{ mol Cu}_2\text{S}$	$0.1885 \text{ mol Cu}_2\text{S} \times 3$ $\text{mol O}_2 / 2 \text{ mol Cu}_2\text{S} =$ $0.2878 \text{ mol O}_2 \text{ needed}$	Since you need 0.2223 mol of $\text{Cu}_2\text{S}$ , but you only have 0.1885 mol of $\text{Cu}_2\text{S}$ , $\text{Cu}_2\text{S}$ is the limiting reactant.
$\text{O}_2$	$7.47 \text{ L} \times \frac{1 \text{ mol O}_2}{22.4 \text{ L}}$ $= 0.3333 \text{ mol O}_2$	$0.3333 \text{ L O}_2 \times 2 \text{ mol}$ $\text{Cu}_2\text{S} / 3 \text{ mol O}_2 =$ $0.2223 \text{ mol Cu}_2\text{S}$ needed	Since you only need 0.2223 mol of the 0.3333 mol of $\text{O}_2$ , $\text{O}_2$ is the excess reactant.

$$0.1885 \text{ mol Cu}_2\text{S} \times \frac{159.16 \text{ g Cu}_2\text{S}}{1 \text{ mol Cu}_2\text{S}} = 30.00 \text{ g Cu}_2\text{S}$$

### Appendix 3.14: The Behaviour of Solid Copper Immersed in a Water Solution of the Compound Silver Nitrate

In this experiment you will weigh a sample of solid silver nitrate and prepare a water solution of it. You will also weigh a piece of copper wire, place it in the solution, and observe its behaviour. By weighing the copper wire at the close of the experiment you will be able to investigate quantitatively any changes that occur.

Before coming to the laboratory, prepare a data table in your laboratory notebook so you can record the data you will observe.

#### Materials

- copper wire, Cu (30 cm – No. 16 is suitable)
- vial of silver nitrate,  $\text{AgNO}_3$  (provided by teacher)
- large test tube
- beaker (250 mL)
- solid glass rod
- balance
- distilled water
- wash bottle
- drying apparatus

#### Procedure

1. Obtain a 30 cm length of copper wire. Form a coil by wrapping the wire around a large test tube, leaving about 7 cm straight for a handle. Stretch the coil a little so there is some space between the loops (see Figure 1). Weigh the copper coil to the nearest 0.01 g.
2. Weigh a clean, thoroughly dry 250 mL beaker to the nearest 0.01 g. Weigh the vial of silver nitrate,  $\text{AgNO}_3$ , provided by the teacher.
3. Fill the weighed 250 mL beaker about two-fifths full with *distilled* water. Add the solid silver nitrate,  $\text{AgNO}_3$ , to the water. Stir gently with a solid glass rod until all the  $\text{AgNO}_3$  crystals have dissolved. Weigh the empty vial.

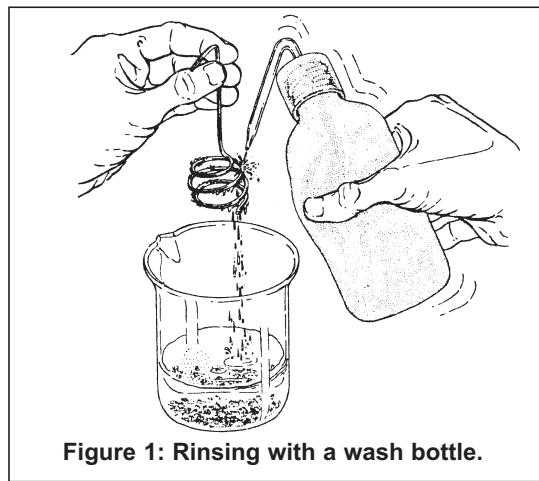

**The Behaviour of Solid Copper Immersed in a Water Solution of the Compound Silver Nitrate—**  
**Source:** Chemical Education Material Study. *Chemistry: An Experimental Science Laboratory Manual*. San Francisco, CA: W.H. Freeman and Company, 1963. 19–21. Adapted by permission of W.H. Freeman and Company/Worth Publishers.

### Appendix 3.14: The Behaviour of Solid Copper Immersed in a Water Solution of the Compound Silver Nitrate (continued)

**Caution:** Silver nitrate, solid or solution, reacts with skin and will stain it black. Be careful and avoid spillage on your skin and clothing. However, don't be alarmed if you discover dark spots on your hands – they wear away in a few days. Clean hands the day following this experiment indicate good laboratory technique.

4. Bend the handle of the weighed copper wire so that it can be hung over the edge of the beaker with the coil immersed in the  $\text{AgNO}_3$  solution. Place the coil into the beaker and observe any changes that take place for several minutes at least.
5. Cover the beaker with a watch glass and place it in your locker until the next laboratory period.
6. At the beginning of the next laboratory period, very carefully open your locker and lift the beaker to the desktop. Observe what has happened in the beaker. Record *all* your observations in your laboratory notebook.
7. Shake the crystals off the coil and lift the coil from the solution. Use your wash bottle to rinse into the beaker any crystals that tend to adhere to the coil. (See Figure 1.) Set the coil aside to dry. Weigh it when dry.
8. Let the crystals settle in the beaker. Carefully decant the solution. Decant means to pour off liquid, leaving solid behind, as shown in Figure 2. Add 5 mL of dilute silver nitrate solution and stir gently until any flecks of copper disappear. Carefully decant again. Wash the residue with 10 mL of water and carefully decant. Wash and decant at least three more times. You may neglect the few particles that may float over with the wash water since the amount is usually not weighable.
9. After the final washing, the residue must be dried. The teacher will suggest a suitable method. If the sample is dried overnight with heat lamps or in a drying oven, it should be dry when you return to the laboratory. Allow the beaker and contents to cool before weighing. Use the same balance as you used previously and record the weight together with the uncertainty.

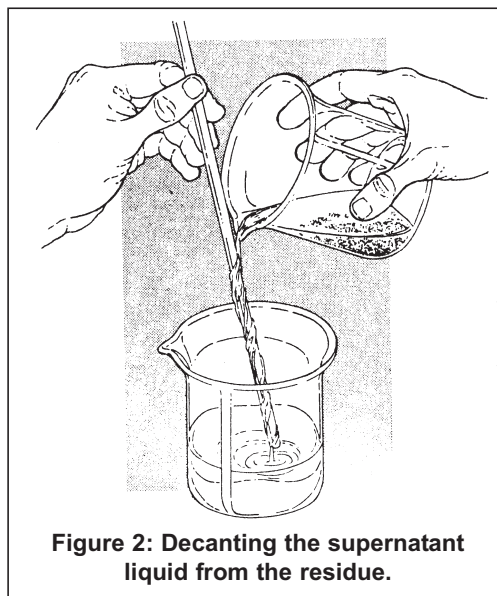

Figure 2: Decanting the supernatant liquid from the residue.

**Note:** If a sand bath is used to dry the sample, you can make sure that it is dry as follows. Weigh the sample and beaker, then return the sample to the sand bath and heat it for a second time. Weigh it again. If weight was lost, you did not have a dry sample and it may not be dry this time, so heat and weigh it again. Repeat the procedure until a constant weight is obtained.

### Appendix 3.14: The Behaviour of Solid Copper Immersed in a Water Solution of the Compound Silver Nitrate *(continued)*

#### Data Table

Your data table should include the following. Be sure to include uncertainty as part of your recorded data.

Data Table	
Weight of copper before immersion in solution	
Weight of copper at close of experiment	
Weight change of copper	
Weight of vial plus silver nitrate	
Weight of vial	
Weight of silver nitrate	
Weight of beaker plus silver	
Weight of beaker	
Weight of silver	

#### Calculations

1. Calculate the number of moles of copper that reacted.
2. Calculate the number of moles of silver obtained.
3. Determine the ratio of moles of silver to moles of copper involved in this reaction. Be sure to express your calculations using the correct number of significant figures.

#### Questions

1. What you have observed can be described by the following statement:

One mole of copper (*solid*) + \_\_\_\_\_ mole(s) of  
 silver nitrate (*in water*) → \_\_\_\_\_ mole(s) of silver (*solid*)  
 + \_\_\_\_\_ mole(s) of copper nitrate (*in water*).

Using the results obtained in this experiment, write the proper whole number coefficients in the above statement when 1 mole of copper is used up.

2. How many atoms of solid copper were involved in your experiment?
3. How many atoms of solid silver were involved in your experiment?
4. What is the relationship between the number of atoms of silver and the number of atoms of copper calculated in questions 2 and 3?

**Appendix 3.14: The Behaviour of Solid Copper Immersed in a Water  
Solution of the Compound Silver Nitrate** *(continued)*

---

5. In order to evaluate the results of this experiment, the teacher will collect the data obtained by other members of your class. Make a graph, plotting the number of individuals obtaining a given silver/copper ratio along the vertical axis. Plot the Ag/Cu ratios along the horizontal axis. These should be rounded off so that each division on the graph will represent values of  $\pm 0.05$ . For example, values from 1.85 up to but not including 1.95 should be plotted as 1.9.
6. Considering only the middle two-thirds of the data plotted, what is the range of values obtained? How does this compare with the uncertainty you considered justifiable from your measurements?

**Questions to Wonder About**

1. What causes the colour in the solution after the reaction is completed?
2. What is the nature of the particles in aqueous solution?

## Appendix 3.15: A Quantitative Investigation of the Reaction of a Metal with Hydrochloric Acid

In this activity, you will determine the volume of hydrogen gas that is produced when a sample of magnesium metal reacts with hydrogen chloride (also recognized as hydrochloric acid) dissolved in water. The volume of the hydrogen gas will be measured at room temperature and pressure – conditions that matter for gases.

### Question

The data you obtain from this experiment will enable you to answer the following question:

How many litres of dry hydrogen gas at room temperature and 1 atmosphere (atm) can be produced per mole of magnesium metal?

### Materials

- magnesium, Mg, ribbon (5 cm)
- fine copper wire
- ring stand and utility clamp
- gas measuring tube (50 mL) fitted with one- or two-hole rubber stopper
- beaker (400 mL)
- hydrochloric acid
- water
- large cylinder or battery jar

### Procedure

1. Obtain a piece of magnesium, Mg, ribbon approximately 5 cm long. Measure the length of the ribbon carefully and record this to the nearest 0.05 cm. The teacher will give you the weight of 1 metre of the ribbon, and since it is uniform in thickness you can calculate the weight of the magnesium used.
2. Fold the magnesium ribbon so that it can be encased in a small spiral cage made of fine copper wire. Leave about 5 cm of copper wire to serve as a handle (see Figure 1).
3. Set up a ring stand and utility clamp in position to hold a 50 mL gas measuring tube that has been fitted with a one- or two-hole rubber stopper, as shown in Figure 1. Place a 400 mL beaker about two-thirds full of tap water near the ring stand.
4. Incline the gas measuring tube slightly from an upright position and pour in about 10 mL of moderately concentrated hydrochloric acid labelled 6 M HCl.

---

#### **A Quantitative Investigation of the Reaction of a Metal with Hydrochloric Acid—Source:**

Chemical Education Material Study. *Chemistry: An Experimental Science Laboratory Manual*. San Francisco, CA: W.H. Freeman and Company, 1963. 26–30. Adapted by permission of W.H. Freeman and Company/Worth Publishers.

**Appendix 3.15: A Quantitative Investigation of the Reaction of a Metal  
with Hydrochloric Acid (continued)**

---

5. With the tube in the same position, slowly fill it with tap water from a beaker. While pouring, rinse any acid that may be on the sides of the tube so that the liquid in the top of the tube will contain very little acid. Try to avoid stirring up the acid layer in the bottom of the tube. Bubbles clinging to the sides of the tube can be dislodged by tapping the tube gently.
6. Holding the copper coil by the handle, insert the metal about 3 cm down into the tube. Hook the copper wire over the edge of the tube and clamp it there by inserting the rubber stopper. The tube should be completely filled so that the stopper displaces a little water when put in place (see the left of Figure 1).
7. Cover the hole(s) in the stopper with your finger and invert the tube in the container of water, as shown in the middle of Figure 1. Clamp it in place. The acid, being denser than water, will diffuse down through it and eventually react with the metal.
8. After the reaction stops, wait for about five minutes to allow the tube to come to room temperature. Dislodge any bubbles clinging to the sides of the tube.
9. Cover the hole(s) in the stopper with your finger and transfer the tube to a large cylinder or battery jar that is almost filled with water at room temperature (see Figure 2). Raise or lower the tube until the level of the liquid inside the tube is the same as the level outside the tube. This permits you to measure the volume of the gases in the tube (hydrogen and water vapour) at room pressure. Read the volume with your eye at the same level as the bottom of the *meniscus* (the lens shape surface taken by the water in the tube). Record the volume of the gas to the nearest 0.05 mL.
10. Remove the gas measuring tube from the water and pour the acid solution it contains down the sink. Rinse the tube with tap water.
11. Record the room temperature. The teacher will give you the room pressure or will assist you in reading the barometer to obtain a value for the pressure in the room.

The experiment may be repeated with another sample of magnesium to check your results, if time permits.

Appendix 3.15: A Quantitative Investigation of the Reaction of a Metal with Hydrochloric Acid (continued)

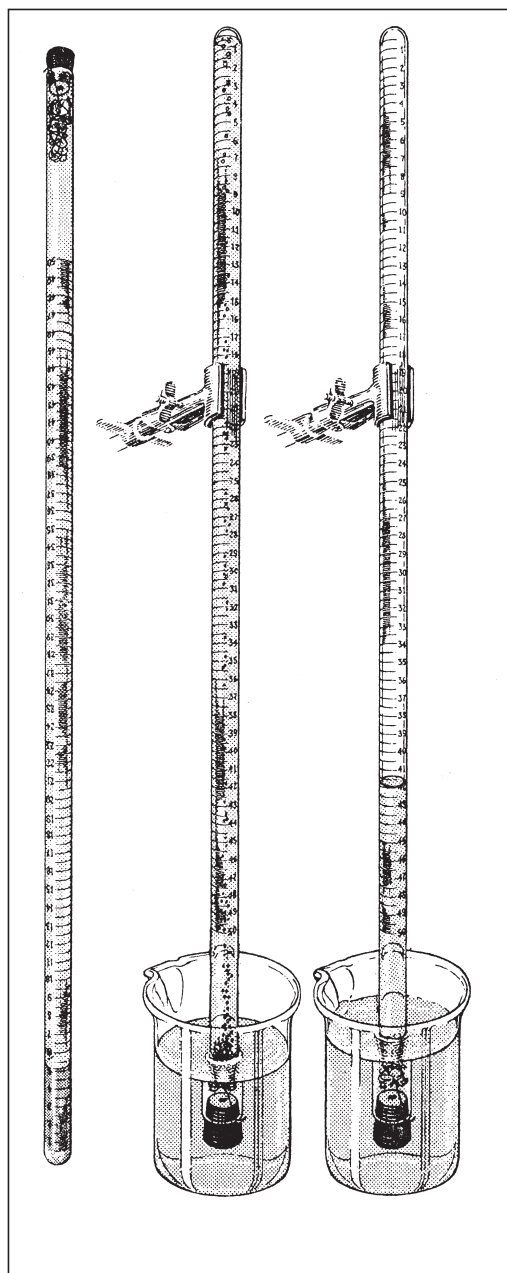

**Figure 1:**  
Manipulating the gas measuring tube.

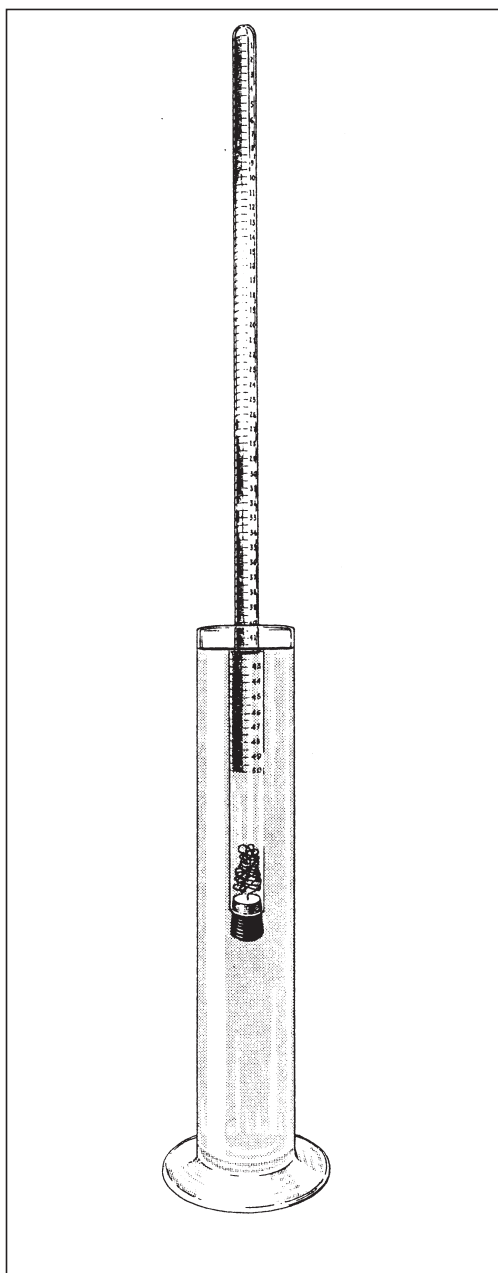

**Figure 2:**  
Measuring the volume of gas.



**Appendix 3.15: A Quantitative Investigation of the Reaction of a Metal  
with Hydrochloric Acid (continued)****Data Table**

The data table should include the following.

<b>Data Table</b>	
Weight of magnesium ribbon in grams per metre (from teacher)	
Length of magnesium ribbon	
Volume of hydrogen (saturated with water vapour)	
Temperature of the water	
Temperature of the room	
Barometer reading (room pressure)	
Vapour pressure of water at the above temperature (see the following table)*	

\* You will need this information in order to perform the necessary calculations.

<b>Vapour Pressure of Water at Various Temperatures</b>	
<b>Temperature (°C)</b>	<b>Pressure (mm)</b>
15	12.8
16	13.6
17	14.5
18	15.5
19	16.5
20	17.5
21	18.6
22	19.8
23	21.0
24	22.4
25	23.8
26	25.2
27	26.7
28	28.3
29	30.0
30	31.8

### Appendix 3.15: A Quantitative Investigation of the Reaction of a Metal with Hydrochloric Acid (continued)

#### Calculations

1. Determine the weight of the magnesium you used from the grams-per-metre relationship and the length of the ribbon.
2. Determine the number of moles of magnesium used.
3. Determine the partial pressure of the hydrogen gas.

Since the hydrogen gas was collected over water, the gas in the tube consists of a mixture of hydrogen gas and water vapour. The total pressure caused by these two gases is equal to the room pressure. Mathematically this can be expressed as follows:

$$P_{\text{H}_2} + P_{\text{H}_2\text{O}} = P_{\text{room}}$$

The pressure of the room may be determined by reading the barometer. The pressure of the water vapour,  $P_{\text{H}_2\text{O}}$ , can be determined from the table given above. The values in the table were obtained by measuring the pressure of water vapour above liquid water at various temperatures. The partial pressure of the hydrogen can then be calculated as follows:

$$P_{\text{H}_2} = P_{\text{room}} - P_{\text{H}_2\text{O}}$$

4. Determine the volume of the hydrogen gas at 1 atmosphere pressure (760 mm) and 0°C.

You have learned that for a given temperature the product of the pressure and volume of a gas is a constant.  $PV = k$ . To calculate the new volume,  $V_{\text{new}}$  at 760 mm pressure, the following mathematical relationship can be stated:

$$V_{\text{measured}} P_{\text{H}_2} = V_{\text{new}} 760$$

or

$$V_{\text{new}} = V_{\text{measured}} \times \frac{P_{\text{H}_2}}{760}$$

5. Calculate the volume of dry hydrogen that would be produced by 1 mole of magnesium at room temperature and 1 atmosphere pressure.

#### Questions

1. Given that 1 mole of Mg produces 1 mole of hydrogen,  $\text{H}_2$ , what is the volume of 1 mole of hydrogen at room temperature and 1 atmosphere pressure?
2. If 1 mole of hydrogen weighs 2.0 g, what is the weight of a litre (the density) of hydrogen at room temperature and 1 atmosphere pressure?

## Appendix 3.16: Stoichiometry: Reactants, Products, and Enthalpy Changes (Student Experiment)

---

Through a series of chemical reactions involving the same two reactants, we will monitor the amount of product produced. By holding the total moles of reactants used constant and varying their relative amounts, maximum product formation will be determined. This method allows us to monitor the amount of product produced using the most convenient method available—in this case, the temperature. Any property that allows quantitative measurement of a product can be used.

### Question

By combining various mole ratios of reactants and analyzing their products, what will be the reactant coefficients of a chemical reaction?

### Prediction

If we determine the maximum amount of heat produced by a certain ratio of reactants, what will their coefficients be?

### Equipment

- computer system and temperature sensor
- thermometer
- stirring rod
- foam cups
- 2 graduated cylinders
- 5% sodium hypochlorite, NaOCl—household laundry bleach (500 mL - 0.05 M)
- potassium iodide solution, KI (500 mL - 0.05 M)

Be sure the chemicals and apparatus are at room temperature before beginning.

### Safety Precautions

- Wear a lab apron and safety goggles.
- Sodium hypochlorite is a severe irritant to eyes, skin, and mucous membrane.
- Potassium iodide is harmful if swallowed.
- Use caution with all solutions, as some are caustic, poisonous, or will stain clothing.
- Do not pour anything down the drain.

### Appendix 3.16: Stoichiometry: Reactants, Products, and Enthalpy Changes (Student Experiment) *(continued)*

#### Procedure

1. Prepare a data table as shown below.

(**Note:** The “average minimum temperature” for each row will be the same, as all the reactions will begin at the same temperature.)

Data Table								
Trial #	mL Ratio	Volume of NaOCl Used (mL)	Moles of NaOCl Used (mol)	Volume of KI Used (mL)	Moles of KI Used (mol)	Average Maximum Temperature (°C)	Average Minimum Temperature (°C)	Change in Temperature (°C)
1	20:80	20		80				
2	40:60	40		60				
3	60:40	60		40				
4	80:20	80		20				

2. Connect the computer system with the temperature sensor and create a digits display and a graph display of the data.
3. Start the data recording.
4. Use a graduated cylinder to measure and pour 20 mL of NaOCl into a clean foam cup.
5. Measure the temperature of the 20 mL of NaOCl.
6. Using another graduated cylinder, measure 80 mL of KI and record its temperature.
7. Enter the average of the two temperatures into the Trial #1 row and under the Average Minimum Temperature column in the table.
8. Pour the KI into the foam cup with the NaOCl while recording the temperature. Gently stir the mixture with the temperature sensor.
9. After the temperature rises and once the temperature begins to fall, stop recording.
10. Remove the thermometer and stirring rod and wipe both clean.
11. Repeat steps 3 to 10 using volume ratios of NaOCl and KI at 40:60, 60:40, and 80:20.
12. Discard the solutions as directed by the teacher. Do not pour anything down the drain.

**Appendix 3.16: Stoichiometry: Reactants, Products, and Enthalpy Changes  
(Student Experiment) (continued)**

---

**Questions****Analysis**

1. For each of the volumes listed for both NaOCl and KI, calculate the number of moles of each used in the trials (remember that each chemical's concentration is 0.50 M and number of moles = M x volume). Enter these values into the table.
2. For each trial, find the maximum temperature attained. Record this under the Average Maximum Temperature column.
3. Calculate and record the Change in Temperature by subtracting the average minimum temperature from the average maximum temperature in each row.
4. With which trial number did the temperature rise the most?
5. What was this maximum temperature change?
6. What was the ratio of volume of NaOCl to KI during the maximum change in temperature?
7. What was the ratio of moles of NaOCl to KI during the maximum change in temperature?

**Conclusions**

8. What are the simplest whole numbers, making use of the maximum temperature mole ratio, that would satisfy the equation  $x\text{NaOCl} + y\text{KI} \rightarrow \text{products} + \text{heat}$ ? You are not expected to know the coefficients of the products.
9. Which chemical was the limiting agent?

**Applications**

10. Other reactants you could mix with NaOCl might include sodium thiosulphate,  $\text{Na}_2\text{S}_2\text{O}_2$ , and sodium sulphite,  $\text{Na}_2\text{SO}_3$ .

## Appendix 3.16: Stoichiometry: Reactants, Products, and Enthalpy Changes (Teacher Notes)

### Sample Data: Answer Key

#### Observations

Data Table								
Trial #	mL Ratio	Volume of NaOCl Used (mL)	Moles of NaOCl Used (mol)	Volume of KI Used (mL)	Moles of KI Used (mol)	Average Maximum Temperature (°C)	Average Minimum Temperature (°C)	Change in Temperature (°C)
1	20:80	20	0.01	80	0.04	22.4	19.3	3.1
2	40:60	40	0.02	60	0.03	25.9	19.3	6.6
3	60:40	60	0.03	40	0.02	29.6	19.3	10.3
4	80:20	80	0.04	20	0.01	27.7	19.3	8.4

#### Analysis

1.

Trial #	Volume of NaOCl Used (mL)	Moles of NaOCl Used (mol)	Volume of KI Used (mL)	Moles of KI Used (mol)
1	20	0.01	80	0.04
2	40	0.02	60	0.03
3	60	0.03	40	0.02
4	80	0.04	20	0.01

2.

Trial #	Average Maximum Temperature (°C)	Average Minimum Temperature (°C)
1	22.4	19.3
2	25.9	19.3
3	29.6	19.3
4	27.7	19.3

**Appendix 3.16: Stoichiometry: Reactants, Products, and Enthalpy Changes  
(Teacher Notes) (continued)**

---

3.

Trial #	Change in Temperature (°C)
1	3.1
2	6.6
3	10.3
4	8.4

4. Trial #3  
5. Approximately 10.3°C  
6. 60:40 or 3:2  
7. 0.03:0.02 or 3:2

**Conclusions**

8.  $3\text{NaOCl} + 2\text{KI} \rightarrow \text{products} + \text{heat}$   
9. NaOCl was the limiting reagent.

**Applications**

10. Other reactants you could mix with NaOCl might include sodium thiosulphate,  $\text{Na}_2\text{S}_2\text{O}_2$ , and sodium sulphite,  $\text{Na}_2\text{SO}_3$ .

# TOPIC 4:

## SOLUTIONS

### APPENDICES

---

- Appendix 4.1: Polar and Non-polar Substances 3
- Appendix 4.2: Why Don't Water and Oil Mix? 7
- Appendix 4.3: Constructing a Solubility Curve 8
- Appendix 4.4: Unsaturated, Saturated, and Supersaturated Solutions 13
- Appendix 4.5: Crystals and Crystal Growing 15
- Appendix 4.6: Solubility Curve 17
- Appendix 4.7: The Effects of Salt and Antifreeze on the Melting Point of Ice 18
- Appendix 4.8: The Effect of Antifreeze on the Boiling Point of Water 19
- Appendix 4.9: Heat Transfer: I Scream, You Scream, We All Scream for Ice Cream 20
- Appendix 4.10: The Effect of Salt on the Melting Point of Ice 22
- Appendix 4.11: A WebQuest for Solubility Units 25
- Appendix 4.12: Solutions: A Scavenger Hunt 26





## Appendix 4.1: Polar and Non-polar Substances

---

### Purpose

In this lab, you will discover which substances, when mixed, will form solutions. You will also create a general rule about solutions created from polar and non-polar substances.

### Materials

- goggles
- test tubes
- test tube rack
- rubber stoppers
- graduated cylinder (10 mL)
- paper towels
- scoopulas
- Material Safety Data Sheets (MSDS)

### Substances

- *Polar Substances*
  - copper(II) sulphate crystals,  $\text{CuSO}_4$
  - water,  $\text{H}_2\text{O}$
  - vinegar
- *Non-polar Substances*
  - solid iodine crystals
  - vegetable oil
  - kerosene

### Procedure

1. Using the following chart as a guide, mix all possible combinations of the substances above. The teacher will show you how much solid to add.
2. If the substance is a liquid, then use 10 mL.
3. If the solution is a solid to be mixed with a liquid, then add the solid first to a clean, dry test tube.
4. Once the substances are added to the test tubes they should be swirled to mix.
5. Dispose of the solutions as directed by the teacher.

## Appendix 4.1: Polar and Non-polar Substances (continued)

## Observations

Substance	Copper(II) Sulphate	Water	Vinegar	Solid Iodine	Vegetable Oil	Kerosene
Copper(II) Sulphate	X	X	X	X	X	X
Water		X	X	X	X	X
Vinegar			X	X	X	X
Solid Iodine				X	X	X
Vegetable Oil					X	X
Kerosene						X

## Discussion Questions

1. What did you observe regarding the mixing of polar and non-polar substances?
2. Based on the general rule about solutions created from polar and non-polar substances, determine whether the following substances are polar or non-polar.
  - a) cobalt(II) chloride crystals, which are soluble in water
  - b) ammonia gas, which is soluble in water
  - c) trichlorotrifluoroethane (TTE) liquid, which is not miscible in water
3. Write a general rule that can be applied to polar and non-polar substances when they are mixed.

## Appendix 4.1: Polar and Non-polar Substances (Teacher Notes)

### Purpose

The purpose of this lab is to have students to discover the relationship between polar and non-polar substances when mixed (i.e., “like dissolves like”).

### Procedure and Precautions

Review the current Material Safety Data Sheet (MSDS) for each of the substances with students and have the data sheets available during the lab in case of an accident. First aid treatment instructions are provided on each MSDS.

The approximate amount of solid iodine required for the lab should be placed in a beaker that is, in turn, placed on a clearly labelled paper towel in a fume hood. Any solid iodine left over after the experiment should be disposed of using Workplace Hazardous Materials Information System (WHMIS) procedures.

By placing a few crystals of each solid on a watch glass, students will understand how much to use for each solution. Have students transfer the crystals directly into their test tubes at the dispensing site.

Samples of the other substance should also be placed on clearly labelled paper towels. If an automatic dispensing pipette is available, the liquids should be dispensed in this manner with the set screw adjusted to 10 mL. Otherwise, a clean 10 mL graduated cylinder should be available for each liquid to be measured by students.

**Note:** Placing food dye into the liquid mixtures will identify the polar solvents.

### Answer Key

1. Student observations:
  - Typical observations for the immiscible liquid combinations will be:
    - They do not mix.
    - They separate into layers.
    - They mix when shaken but gradually separate out into distinct layers.
  - Iodine should not dissolve and go into solution with water, as iodine and water are “unlike” components.
  - The same is true for kerosene and copper sulphate.
2. a) Cobalt(II) chloride must be polar, as it dissolves in polar water.  
b) Ammonia gas must be polar, as it dissolves in water.  
c) TTE must be non-polar, as it does not dissolve in polar water.

### Appendix 4.1: Polar and Non-polar Substances (Teacher Notes) *(continued)*

---

3. Possible statements:

- If *both* substances are polar or non-polar, then they will dissolve or be miscible.
- If a polar substance is mixed with a non-polar substance, they will not dissolve. They will be immiscible.
- Like substance will dissolve like substance.

## Appendix 4.2: Why Don't Water and Oil Mix? (Demonstrations—Teacher Notes)

Use the following demonstrations to help students develop an understanding of the molecular interactions between polar and non-polar molecules.

### Demonstration A

- Cut ovals (2 cm x 3 cm) and rectangles (2 cm x 3 cm) from an acetate sheet.
  - Using black markers, label one end of the oval positive (+), and the other end negative (-). The ovals represent polar water molecules.
  - Using a different colour of marker, label the rectangles as neutral. The rectangles represent oil molecules.
- Place the ovals and rectangles on the overhead projector and ask students to predict what will happen. Students will likely predict that the negative end of one oval will attract the positive end of another oval. Matching the ovals in this way results in the expulsion of the rectangles, producing two layers – one layer of polar molecules and a second layer of non-polar molecules.
- Relate this demonstration to the attraction of water, a polar substance, to an electrostatically charged comb.
- Discuss hydrogen bonding and dipole-dipole interactions.

### Demonstration B

- Place the magnetic stir bars and clear marbles into a petri dish (see Figure A).
  - The stir bars represent polar molecules.
  - The marbles represent non-polar molecules.

Ask students to predict what will happen when the dish is agitated. Shake the petri dish (see Figure B). This motion results in a separation of the two phases (i.e., the magnets attract each other and exclude the marbles).
- Add different shaped stir bars (another polar substance) and coloured marbles (another non-polar substance) to the petri dish. Ask students to predict what will happen when the dish is agitated. Shake the petri dish (see Figure C). Again, the polar molecules will be attracted to each other and exclude the non-polar molecules, thus creating two distinct regions.
- This demonstration illustrates the concept of “like dissolves like.”

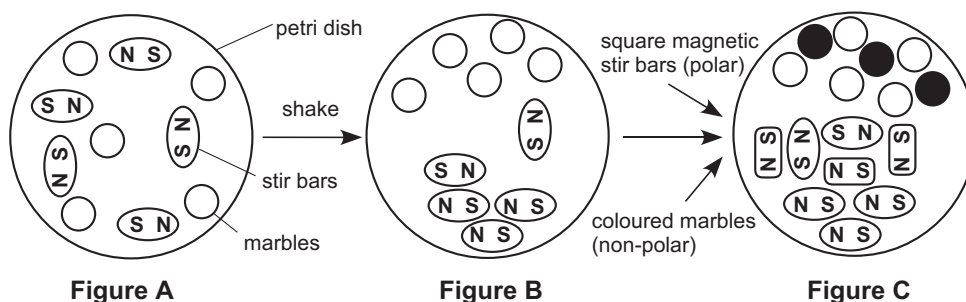

## Appendix 4.3: Constructing a Solubility Curve

---

### Pre-Lab Discussion

The amount of solute required to achieve a saturated solution in water depends upon the temperature. Most solid solutes increase in solubility as temperature increases in a liquid solution. A solubility curve can be created by varying the amount of solute, keeping the amount of solvent constant, and determining at what temperature all the solute dissolves (or conversely, we can see when the solute particles start to reappear as we slowly cool the solution).

In this experiment, student groups will be assigned a specific amount of solute to dissolve. There are two procedures that will introduce a significant error into the results: the measurement of both the solid and the temperature when precipitation occurs. The temperature can be checked, whereas the solid measurement can be done only ONCE. After the graphs have been drawn from the class data, it will be very obvious whose data are incorrect.

### Problem

At what temperature does the given amount of solute precipitate?

### Materials

- ammonium chloride,  $\text{NH}_4\text{Cl}$
- distilled water
- graduated cylinder
- balance
- filter paper
- scoopula
- Bunsen burner
- matches
- 2 thermometers
- thermometer clamps
- 30 cm length of 18-gauge copper wire  
(Bend the wire into a large loop to go around the thermometer to stir the solution. The end of the wire should extend well above the top of the test tube.)
- test tubes (20 x 200 mL)
- beaker (400 mL)
- tap water

### Procedure

1. Mass out exactly \_\_\_\_\_ g of  $\text{NH}_4\text{Cl}$ .
2. Measure out exactly 20 mL of distilled water in a graduated cylinder.

Appendix 4.3: Constructing a Solubility Curve (*continued*)

3. Place both the water and the solute into a large test tube and stir with the copper wire instrument you created. Place one thermometer into the test tube and a second thermometer into a water bath. Wherever possible, use a specialized thermometer clamp to hold the thermometer off the bottom of the test tube.
4. Use a hot water bath to heat the solution about 10°C higher than the point at which the solute looks entirely dissolved.
5. Allow the solution to cool, with constant stirring, and record the temperature when the solute begins to precipitate out. The precipitate may be very obvious, or the solution may just begin to look cloudy.
6. Repeat steps 4 and 5 two more times. Remember, you should heat solutions to about 10°C higher than the temperature you will actually record each time. Take the temperature after a cooling period has elapsed and a precipitate just becomes visible.
7. Record the data in the table provided.
8. Examine the temperature data. Discard unreasonable data, and perform steps 4 and 5 until three sets of comparable data are achieved. Average the three best temperatures used.

**Observations**

Individual Data	
Trial #	Temperature (°C)
#1	
#2	
#3	
#4	
#5	
Average	

Group Data						
Solubility (g/20 g of Water)						
Solubility (g/100 g of Water)						
Temperature (°C)						



### Appendix 4.3: Constructing a Solubility Curve (*continued*)

---

#### Questions

1. Why is it important to measure out exactly the given amount of solute and solvent?
2. Use the class data to construct a graph with temperature on the horizontal axis and solubility (g of solute/100 g of water) on the vertical axis.
3. Does the class data produce a smooth-flowing curve? Are there any points that are not on the curve? Explain these anomalies.
4. What is the relationship between temperature and solubility on this graph?
5. What does a point on the line represent?
6. Determine the solubility of ammonium chloride at 10°C and at 90°C. Explain how these values were determined.

## Appendix 4.3: Constructing a Solubility Curve (Teacher Notes)

Having students collect data for all the points on the solubility curve is unnecessary. For this experiment it is suggested that student groups be assigned a specific amount of solute to dissolve. Students can carefully collect data for one of the points on the curve and still develop the necessary lab skills. Another option would be to have student groups collect data for more than one point on the curve.

Teachers have the option of providing students with the following information to encourage them to produce their best work and to strive for accuracy and precision. There are, of course, two procedures that will introduce a significant error into the results: the measurement of the solid and the temperature when precipitation occurs. The temperature can be checked and averaged, whereas the solid measurement can be done only ONCE. After the graphs have been drawn from the class data, it will be very obvious whose data are incorrect.

Below are the recommended amounts of solute to assign to lab groups to produce the best solubility curve. If there are more than six groups, then multiples of one mass of solute will provide a greater degree of precision. Note that three significant figures are suggested.

Recommended Amounts of Solute to Dissolve		
Lab Group	Grams of $\text{NH}_4\text{Cl}$ / 20 g of Water	Temperature (°C)
#1	8.00 g	~28°C
#2	9.00 g	~39°C
#3	10.00 g	~50°C
#4	11.00 g	~60°C
#5	12.00 g	~70°C
#6	13.00 g	~78°C

The solubility curve for ammonium chloride,  $\text{NH}_4\text{Cl}$ , can be found in most chemistry texts.

### Extensions

1. Have students discuss the instances of experimental errors.
2. Students could use Vernier's *Graphical Analysis*<sup>®</sup> software (provided under a provincial site licensing agreement) to graph the curve and determine a mathematical relationship for solubility and temperature.
3. Have one group conduct several trials when stirring and when not stirring the solution.

### Appendix 4.3: Constructing a Solubility Curve (Teacher Notes) *(continued)*

---

#### Answers to Questions and Discussion

1. If an incorrect amount of solute is measured out, the temperature results will not produce a point that will fit a smooth-flowing curve.
2. Students draw the graph either manually or by using plotting software.
3. Answers will vary. Usually, several points are not close to the best-fit curve due to carelessness. Students will usually say that either the solid was not massed accurately or the temperature was incorrect. If students do not stir continuously, super cooling will occur and the solid will not precipitate until the solution reaches a lower than expected temperature. (See Extensions.)
4. The solubility of ammonium chloride is directly proportional to the temperature of the solvent.
5. The solubility of ammonium chloride at that temperature.
6. The solubility of ammonium chloride at 10°C is approximately 33 g/100g H<sub>2</sub>O, and at 90°C it is 73 g/100g H<sub>2</sub>O. Both values were determined by extrapolation from the data.

## Appendix 4.4: Unsaturated, Saturated, and Supersaturated Solutions

### Problem

To distinguish between unsaturated, saturated, and supersaturated solutions.

### Materials

- sodium thiosulphate pentahydrate,  $\text{Na}_2\text{S}_2\text{O}_3 \cdot 5\text{H}_2\text{O}$ , crystals
- beaker (400 mL)
- 3 test tubes (18 x 150 mm)
- hot plate
- stirring rod
- water

### Procedure

1. Make a water bath by pouring about 250 mL of water into a 400 mL beaker. Place the beaker on a hot plate, and heat the water to just boiling.
2. Place about 2.5 to 3 g (1.5 to 2 cm) sodium thiosulphate crystals into an 18 x 150 mm test tube. Add 1 mL of water. Heat in the boiling water bath until all crystals have dissolved.
3. Remove the test tube from the water bath and label it as test tube A.
4. Allow test tube A and its contents to cool to room temperature (about half an hour or overnight).
5. Place about 2.5 to 3 g (1.5 to 2 cm) sodium thiosulphate crystals into an 18 x 150 mm test tube. Add 1 mL of water. Shake and stir to dissolve as much of the solid as possible.
6. Label this test tube as B. Allow test tube B and its contents to settle and come to room temperature.
7. Place enough sodium thiosulphate crystals into an 18 x 150 mm test tube to cover just the bottom of the test tube (approximately 0.2 to 0.3 g). Add 3 mL of water. Shake and stir to dissolve as much of the solid as possible.
8. Label this test tube as C. Allow test tube C and its contents to settle and come to room temperature.
9. When test tube A and its contents are cool, carefully add one small crystal of sodium thiosulphate to each of test tubes A, B, and C. Describe your observations.
10. Hold the bottom of each test tube in your hand. Describe your observations.

### Questions

Answer the following questions, based on your observations.

1. Identify which solutions are unsaturated, saturated, and supersaturated.
2. Describe the differences between unsaturated, saturated, and supersaturated solutions.

## Appendix 4.4: Unsaturated, Saturated, and Supersaturated Solutions (Teacher Notes)

The experiment is intended to show the difference between the following solutions:

- an *unsaturated solution* (test tube C)—an added crystal dissolves in this solution
- a *saturated solution* (test tube B)—a solid is present together with the solution, and adding another crystal has no effect
- a *supersaturated solution* (test tube A)—an added crystal causes the “extra” solute to crystallize out around the seed

Students should also observe the following:

- The test tube and contents become warmer as the solid crystallizes.
- When making the saturated solution, dissolving requires energy, as evidenced by test tube B and its contents becoming colder as solute dissolves.

### Variations

1. Prepare the three solutions (saturated, unsaturated, and supersaturated) in advance. Give corked and labelled test tubes to students and ask them to observe the effect of adding one crystal of sodium thiosulphate pentahydrate to each test tube. These solutions can be reused several times.
2. For a microscale version of the experiment, prepare the supersaturated solution by placing 3 and 4 cm (about a third to half full) of sodium thiosulphate in a 10 x 70 mm test tube and adding 5 drops of water. Use a 100 mL beaker and 50 mL of water for the water bath. Heat the solution in the boiling water bath to dissolve the solid, and allow the solution to cool to room temperature before adding a single crystal of sodium thiosulphate.

**Note:** Sodium thiosulphate is also known as “hypo,” and should be readily available from camera stores.

Solubility of Sodium Thiosulphate Pentahydrate, $\text{Na}_2\text{S}_2\text{O}_3 \cdot 5\text{H}_2\text{O}$ , in Water		
Temperature (°C)	Grams of $\text{Na}_2\text{S}_2\text{O}_3 \cdot 5\text{H}_2\text{O}$ /100 g Saturated Solution	Grams of $\text{Na}_2\text{S}_2\text{O}_3 \cdot 5\text{H}_2\text{O}$ /100 g Water
0	33.40	50.15
10	37.37	59.66
20	41.20	70.07
25	43.15	75.90
30	47.17	91.24
45	55.33	123.87

**Reference:** Solubility data from: Seidel, A., ed. *Solubilities of Inorganic and Organic Compounds*. Vol. 1. New York, NY: D. van Nostrand Co., Inc., New York, 1911.

---

## Appendix 4.5: Crystals and Crystal Growing

---

### A. Rock Candy Sugar Crystals

This is a popular activity because students can grow large edible sugar crystals. This activity can also be done at home.

#### Safety Precautions

If crystals are to be eaten, use only clean household equipment. If crystals are to be observed only, laboratory glassware could be used.

#### Materials

- ½ cup (125 mL) water
- small saucepan
- short length of white string
- pencil
- 1 cup (250 mL) granulated sugar
- small nut or paper clip (to act as a weight)
- wooden spoon
- measuring cup
- tall glass
- hot plate

#### Procedure

1. Clean all equipment thoroughly before use.
2. Tie a small nut or paper clip to one end of a clean piece of white string and tie the other end of the string to a pencil. The string should be just long enough to touch the bottom of the glass when the pencil is resting across the top of the glass.
3. Pour the sugar and water into the saucepan and stir to dissolve as much of the sugar as you can at room temperature. Heat the mixture on the hot plate, stirring constantly. Continue heating until all the sugar is dissolved.
4. Pour the hot syrupy solution into the glass. Hang the string, weighted down with a nut or paper clip, into the solution.
5. Set the glass and contents aside, covered loosely with a piece of paper, in a place where it won't be disturbed. Check the solution daily. Break up any crust that forms on the surface so that water can continue to evaporate as crystals grow along the string.

## Appendix 4.5: Crystals and Crystal Growing (continued)

**B. Crystals on Glass**

Rather than growing large crystals in this activity, students produce small crystals rapidly, for observations on shape and form.

**Materials**

- petri dish, beaker, or drinking glass
- magnesium sulphate,  $\text{MgSO}_4$
- sodium chloride,  $\text{NaCl}$
- sodium carbonate,  $\text{Na}_2\text{CO}_3$
- copper sulphate,  $\text{CuSO}_4$
- hot plate
- stirring rod

**Procedure**

1. Mix the appropriate amounts of solid compound and boiling water (see table below). Stir to dissolve the solid completely. (If necessary, add more boiling water. However, if the solution is too diluted it may take much longer for crystals to appear.)
2. When all the solute has dissolved, pour just enough solution to completely cover the surface of a flat-bottomed glass container (e.g., petri dish, beaker, or drinking glass). Set the container aside. Do not disturb while the water evaporates.
3. Check the solution occasionally. Describe the shape of the crystals as they start to form on the glass. Do they all have the same shape?

Compounds that yield good crystals include the following:

<b>Compounds That Yield Good Crystals</b>		
<b>Substance</b>	<b>Amount of Solute (mL)</b>	<b>Amount of Boiling Water (mL)</b>
Magnesium sulphate, $\text{MgSO}_4$	10	15
Sodium chloride, $\text{NaCl}$	15	30
Sodium carbonate, $\text{Na}_2\text{CO}_3$	15	30
Copper sulphate, $\text{CuSO}_4$	15	30

## Appendix 4.6: Solubility Curve

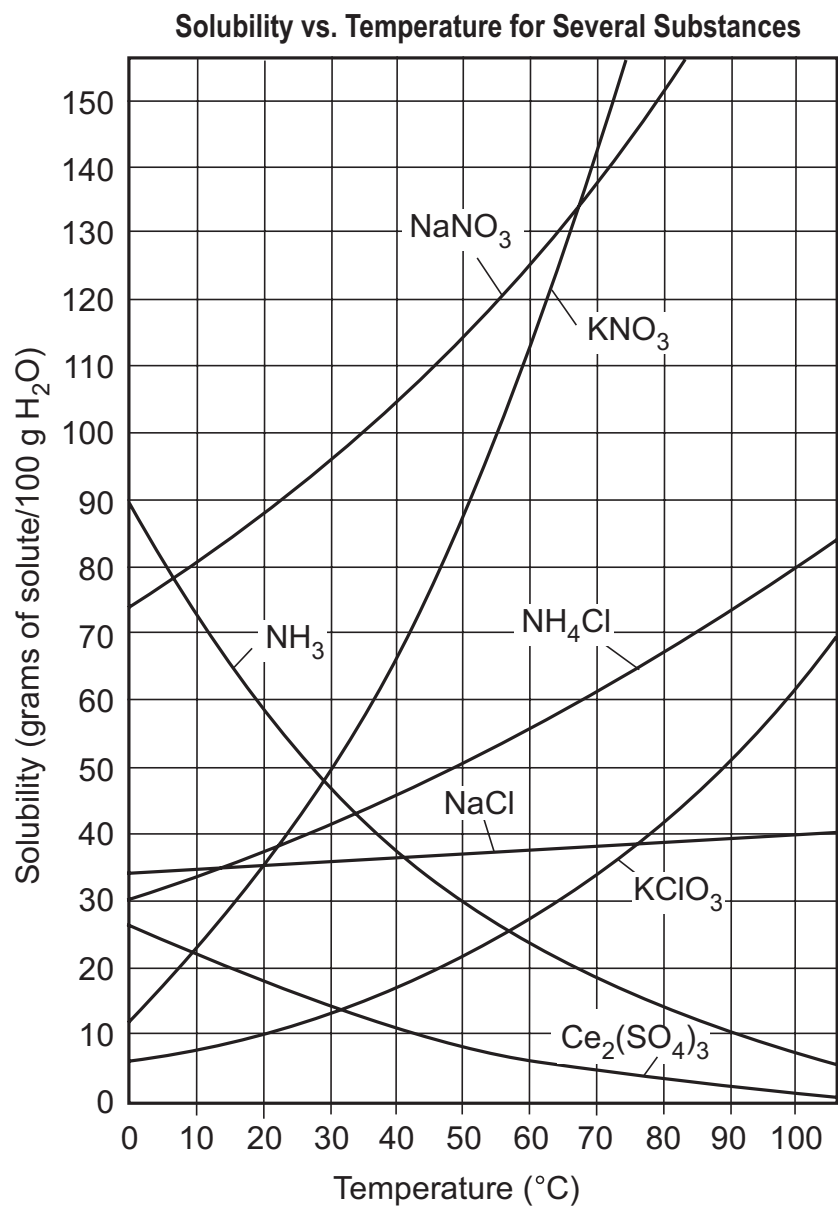



## Appendix 4.7: The Effects of Salt and Antifreeze on the Melting Point of Ice

---

In this investigation you will study the effects of salt and antifreeze on the melting point of ice.

### Materials

- beaker (250 mL)
- thermometer
- coarse table salt
- 10 mL measure
- finely crushed ice (as small as coarse sand)
- antifreeze (ethylene glycol)
- graduated cylinder (25 mL)
- stirring rod

### Procedure A: Effect of Salt on the Melting Point of Ice

1. Pour crushed ice into the beaker until it is half full.
2. Take the temperature of the ice while you are stirring it. Do not stir with the thermometer. Use the stirring rod.
3. When the thermometer reads  $0^{\circ}\text{C}$ , add 1 level measure of salt to the ice. Continue stirring. Record the temperature after it stops changing.
4. Continue adding 1 level measure of salt at a time, with continuous stirring and temperature readings, until you have added 7 or 8 measures.
5. Record your results in a table.
6. Empty the beaker and wash it.

### Procedure B: Effect of Antifreeze on the Melting Point of Ice

The antifreeze used in this investigation is ethylene glycol. It is the permanent type that comes in new cars. Repeat Procedure A, but use 15 mL of antifreeze each time instead of 1 level measure of salt.

### Discussion

1. What evidence do you have that the ice is at its melting point, even after salt and antifreeze are added?
2. What effect does salt have on the melting point of ice?
3. What effect does antifreeze have on the melting point of ice?
4. Explain why salt is added to ice-covered roads.
5. Explain why antifreeze is added to the water in the radiators of cars in cold areas of the country.
6. Why is salt not used in the radiators of cars?
7. Where did the heat go in this experiment? In other words, how can something get colder when you add a warmer substance to it in a warm room?

---

**The Effects of Salt and Antifreeze on the Melting Point of Ice:** Adapted from William A. Andrews, T.J. Elgin Wolfe, and John F. Eix, *Physical Science: An Introductory Study* (Scarborough, ON: Prentice-Hall of Canada, Ltd., 1978) 79–80. Adapted by permission of Pearson Education Canada.

## Appendix 4.8: The Effect of Antifreeze on the Boiling Point of Water

Most vehicle manufacturers recommend leaving the antifreeze in the radiator during the summer. Why would one do this?

### Materials

- round-bottomed flask (250 mL)
- thermometer ( $-10^{\circ}\text{C}$  to  $110^{\circ}\text{C}$ )
- distilled water
- boiling chips
- Bunsen burner
- ring stand
- iron ring
- wire gauze
- 2 adjustable clamps
- 50 mL antifreeze (ethylene glycol, undilute)

### Safety Precaution

Wear safety goggles during this investigation.

### Procedure

1. Set up the apparatus as demonstrated by your teacher. Begin with 100 mL of distilled water in the flask.
2. Heat the water until it is boiling. Note the temperature.
3. Add 10 mL of antifreeze to the water. Continue heating the mixture. Note the new boiling point.
4. Repeat step 3 until all the antifreeze has been used.

### Discussion

1. Describe the effect of antifreeze on the boiling point of water.
2. Why do car makers recommend leaving the antifreeze in a car radiator during the summer?
3. Compare the effects of antifreeze on the boiling point and freezing point of water.
4. Does antifreeze help or hinder boiling? Does antifreeze help or hinder melting?

---

**The Effect of Antifreeze on the Boiling Point of Water:** Adapted from William A. Andrews, T.J. Elgin Wolfe, and John F. Eix, *Physical Science: An Introductory Study* (Scarborough, ON: Prentice-Hall of Canada, Ltd., 1978) 85–86.

## Appendix 4.9: Heat Transfer: I Scream, You Scream, We All Scream for Ice Cream

---

### Purpose

This lab activity is a practical, real-life application of the principles of calorimetry, heat transfer, heat exchange measurements, heat of fusion, specific heat, and freezing point depression.

### Materials

- 2 sandwich-size and 2 large (4 L) resealable plastic bags to make into double-thickness bags (to prevent leaks)
- large bowl
- measuring spoons
- measuring cup
- spoon
- egg beater
- balance
- Celsius thermometer
- 3 cups crushed ice
- 1/2 cup rock salt

### Recipe

- 1/2 cup cream (or half-and-half)
- 1/4 cup milk
- 2 tablespoons sugar
- 1/8 teaspoon vanilla
- 1 beaten egg

### Procedure

1. Measure and record the mass of a sandwich-size plastic, zippered bag.
2. In the large bowl, mix together the cream, milk, sugar, vanilla, and beaten egg. Pour this ice cream mixture into a sandwich-size resealable bag.
3. Measure and record the mass of the ice cream mixture.
4. Measure and record the initial temperature of the ice cream mixture.
5. Place the ice cream mixture into the second sandwich-size bag, making sure the bags are sealed tightly.
6. Place the small bag of ice cream mixture inside the large bag of ice and salt, making sure everything is sealed tightly.
7. Gently rock the bag for about five minutes. (Don't rock too hard, or you'll end up with salty ice cream!)
8. When the ice cream looks frozen enough, remove the small bag from the ice-salt mixture and rinse the bag in cold water to remove any salt on the outside.

---

**Appendix 4.9: Heat Transfer: I Scream, You Scream, We All Scream  
for Ice Cream** *(continued)*

---

9. Measure and record the final temperatures of the ice-salt mixture and the ice cream mixture.
10. Eat the ice cream!

<b>Data Table</b>	
• Mass of small plastic, zippered bag:	_____
• Mass of ice cream mixture + bag:	_____
• Mass of ice cream mixture:	_____
• Initial temperature of ice cream mixture:	_____
• Final temperature of ice cream mixture:	_____
• Final temperature of ice cream mixture:	_____

**Appendix 4.10: The Effect of Salt on the Melting Point of Ice**

---

**Question**

What is the effect of salt on the melting point of ice?

**Prediction**

Predict how the addition of salt will affect the melting temperature of ice.

**Materials**

- computer system and temperature sensor
- beaker (400 mL)
- table salt, NaCl (50 g—divided into 10 portions of 5 g each)
- finely crushed ice (200 mL)
- stirring rod
- support stand
- utility clamp

**Safety Precautions**

- This experiment must be done carefully to avoid burns and broken glass.
- Wear a lab apron and safety goggles.

**Procedure**

1. Set up the computer system with the temperature sensor.
2. Display the temperature sensor with a graph so that temperature is along the vertical axis and time is along the horizontal axis.
3. Add the crushed ice to the beaker and set this on the base of the support stand.
4. Clamp the thermometer into the utility clamp and attach the clamp to the support stand.
5. Lower the thermometer tip into the middle of the crushed ice.
6. Using the stirring rod, stir the ice continuously.
7. Start the data collection.
8. When the thermometer stabilizes, add 5 g of salt to the ice. Continue stirring.
9. Repeat step 8 until you have added 50 g of the salt to the ice.
10. Stop the data recording.
11. Clean up the materials as directed by the teacher.

**Appendix 4.10: The Effect of Salt on the Melting Point of Ice** *(continued)*

---

**Questions****Analysis**

1. What evidence do you have that the ice is at its melting point even after the salt has been added?
2. What appears on the outside of the beaker?
3. What minimum temperature was attained?

**Conclusion**

4. What effect does salt have on the melting point of ice?

**Applications**

5. Explain why salt is added to ice-covered roads.
6. This experiment can be repeated using ethylene glycol (antifreeze) instead of salt.

## Appendix 4.10: The Effect of Salt on the Melting Point of Ice (Teacher Notes)

### Sample Data: Answer Key

#### Observations

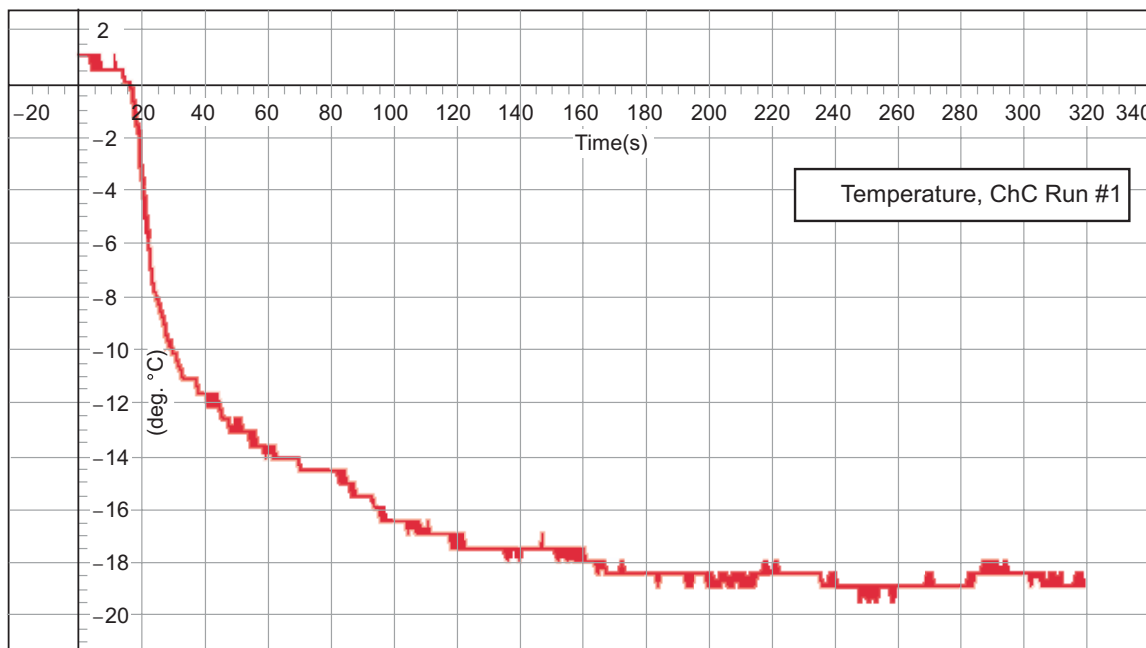

Temperature vs. Time

#### Analysis

1. Both the solid and the liquid states are present.
2. Frost appears on the outside of the beaker.
3. The minimum temperature attained was  $-19^{\circ}\text{C}$ .

#### Conclusion

4. Salt lowers the melting point of ice.

#### Applications

5. Salt dissolves in the fine layer of water found on the surface of ice. The melting point of the ice is then lowered. When the melting point of the ice is below the surrounding temperature, the ice melts.

## Appendix 4.11: A WebQuest for Solubility Units

Work with a partner in the computer lab (or at home) to find answers to the following questions.

- The strength (or concentration) of a solution can be represented in several forms, dependent upon the intended usage or the nature of the components making up the solution. Remember, a solution has two components: a *solute* and a *solvent*. Therefore, these components are often included in the units to express the strength of a solution. Complete the following chart.

Unit to Express the Strength of a Solution	What the Unit Means in Long Form	Example of Where You Might Find This Unit Being Used
<i>Example:</i> g/L	Grams of solute in 1 litre of solution	Mixing powdered chemicals into a swimming pool
% w/v		
% v/v		
ppm		
ppb		
mol/L		

- Describe the process of treating a water supply.
- Identify the allowable concentrations of metallic and organic species in water suitable for human consumption. (Consider tap water, well water and/or bottled water.)



**Appendix 4.12: Solutions: A Scavenger Hunt**

---

You and your partner will search through your chemistry textbook to find answers to the following questions. If you cannot find all the answers there, use another source that your teacher has supplied for you or recommended to you. You will not find all the answers in the same section of the textbook, so it is important that you use the index in the text correctly.

Write a thorough, but precise, answer to each of the following questions. Don't write "stuff" you don't understand or have simply borrowed for the day. Make every effort to write in your own words and in a familiar style. This is an important skill that will help you in any advanced studies.

1. Describe and give examples of various types of solutions. Include all nine possible types.

Type of Solution	Description	Example





# TOPIC 5: ORGANIC CHEMISTRY

## APPENDICES

---

- Appendix 5.1: Underwater Fireworks 3
- Appendix 5.2: Preparation of Esters 6
- Appendix 5.3: Organic Model-Building Presentation 9
- Appendix 5.4: Esters: Flavours and Fragrances 10

**Note:**

Due to copyright considerations, Appendix 5.1: Underwater Fireworks is available only in the print document.



## Appendix 5.2: Preparation of Esters

### Purpose

To study a method for the preparation of esters and to study some of their properties.

### Substances Used

Complete the structural formulas for the following alcohols and carboxylic acids before starting the lab.

Alcohols	Carboxylic Acids
1. isopentyl alcohol (3-methyl-1-butanol)	2. acetic acid ethanoic acid
3. isobutyl alcohol (2-methyl-1-butanol)	4. propanoic acid
5. ethyl alcohol ethanol	6. butanoic acid butyric acid
7. methyl alcohol methanol	8. salicylic acid

### Safety Precaution

In this lab activity, you will be adding a very small amount of concentrated sulphuric acid to four of the test tubes. **This acid is very corrosive.** Your teacher will show you the safe location of this acid and how to add the correct amount safely.

Appendix 5.2: Preparation of Esters (*continued*)**Procedure**

1. Prepare a hot water bath, as indicated by your teacher.
2. Label five test tubes A to E.
3. Using the appropriate eye dropper, add 10 drops of each alcohol and 5 drops of each carboxylic acid to the test tubes according to the Observation Data Table that appears with this activity. Carefully mix the substances.
4. While adding each acid and alcohol to the test tubes, carefully smell each sample and record your observations in the Observation Data Table.
5. **Very carefully** add 4 drops of concentrate sulphuric acid to test tubes B, C, D, and E. Do not add any acid to test tube A.
6. Carefully mix the substances in each test tube.
7. Place the test tubes in the hot water bath for approximately five minutes.
8. Remove the test tubes from the hot water bath.
9. Pour the product from one of the test tubes onto cold water in an evaporating dish. Record the odour in the table provided.
10. Repeat the last procedure for each test tube and record as required.

Observation Data Table						
Test Tube	Alcohol	Odour	Carboxylic Acid	Odour	Ester	Odour
A						
B						
C						
D						
E						

Appendix 5.2: Preparation of Esters (*continued*)

---

**General Observations****Questions**

1. What is the purpose of test tube A?
2. Was there a reaction in test tube A? How do you know?
3. What was the difference between the odour of the reactants and the odour of the products?
4. What conclusion could be drawn from this experiment?

**Reactions**

Write the reaction for each of the test tubes except test tube A in the space below.

<b>Test Tube</b>	<b>Reaction</b>
B	
C	
D	
E	



## Appendix 5.3: Organic Model-Building Presentation (Teacher Notes)

The following activity may be used for assessment as well as for learning, either early in the topic of study or as a review toward the end.

### Preparation

1. Prior to the activity:
  - Give students the prefixes that specify the number of carbon atoms in an organic substituent:  
methyl = 1, ethyl = 2, and so on.
  - Give students some of the basic functional groups using the R group format:  
alcohol = R – O – H, ether = R – O – R', and so on.
  - Introduce the alkane, alkene, and alkyne series, along with the basics of numbering carbon atoms in a molecule.
2. On the day of the presentations, form teams of three to five students. One successful method of forming teams involves assigning those students having difficulty in chemistry as team captains. The captains choose team members and keep their team's score. Students may use whatever resources they have gathered during their study of organic chemistry.
3. Write the name of an organic molecule on the board or overhead projector and ask teams to build the molecule using ball-and-stick models. (**Note:** This game can be played in reverse, for variety. Make the models and ask the teams to write correct IUPAC names.)
4. Award points to all teams who successfully build the model. (For example, if there are five teams, the first team to complete their model scores 5 points, the second team scores 4 points, and so on.)
5. At the end of the class, collect and tally the score sheets.

**Note:** Make every effort to agree upon a scoring system that is friendly to all student groups, and downplay the competitive aspects. The primary goals are to have students participate and to see how well the models agree with theory.

## Appendix 5.4: Esters: Flavours and Fragrances

Esters are a class of compounds widely distributed in nature. They have the following general formula:

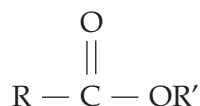

The simpler esters tend to have pleasant odours. In many cases, although not exclusively so, the characteristic flavours and fragrances of flowers and fruits are due to compounds with the ester functional group. An exception is the case of the essential oils. The organoleptic qualities (odours and flavours) of fruits and flowers may often be due to a single ester, but, more often, the flavour or the aroma is due to a complex mixture in which a single ester predominates. Some common flavour principles are listed in Table 1. Food and beverage manufacturers are thoroughly familiar with these esters and often use them as additives to spruce up the flavour or odour of a dessert or beverage. Many times such flavours or odours are not even naturally occurring, as is the case with the “juicy fruit” principle, isopentenyl acetate. An instant pudding that has “rum” flavour may never have seen its alcoholic namesake—this flavour can be duplicated by the proper admixture, along with other minor components, of ethyl formate and isobutyl propionate. The natural flavour and odour are not *exactly* duplicated, but most people can be fooled. Often only a trained person with a high degree of gustatory perception, a professional taster, can tell the difference.

A single compound is rarely used in good quality imitation flavouring agents. A formula for an imitation pineapple flavour, which might fool an expert, is listed in Table 2. The formula includes ten esters and carboxylic acids which may easily be synthesized in the laboratory. The remaining seven oils are isolated from natural sources.

Flavour is a combination of taste, sensation, and odour transmitted by receptors in the mouth (taste buds) and nose (olfactory receptors). The four basic tastes, sweet, sour, salty, and bitter, are perceived in specific areas of the tongue. The sides of the tongue perceive sour and salty tastes, the tip is most sensitive to sweet tastes, and the back of the tongue detects bitter tastes. The perception of flavour, however, is not that simple. If it were, it would only require the formulation of various combinations of four basic substances: a bitter substance (a base), a sour substance (an acid), a salty substance (sodium chloride), and a sweet substance (sugar), to duplicate *any* flavour! In fact, we cannot duplicate flavours in this way. The human tongue actually possesses 9000 taste buds. It is a combined response of these taste buds that allows us to perceive a particular flavour.

---

**Esters: Flavours and Fragrances:** From *Introduction to Organic Laboratory Techniques, A Contemporary Approach* 1st edition by PAVIA. 1976. Reprinted with permission by Brooks/Cole, a division of Thomson Learning; www.thomsonrights.com. Fax 800 730-2215.

## Appendix 5.4: Esters: Flavours and Fragrances (continued)

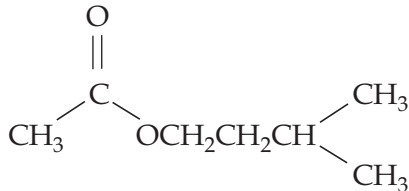
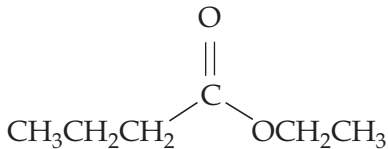
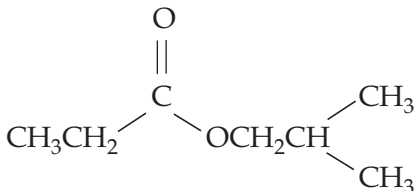
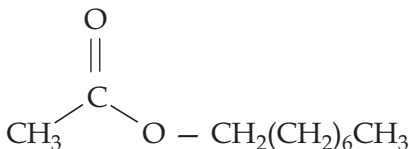
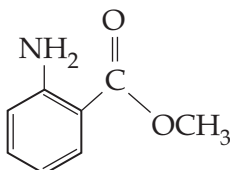
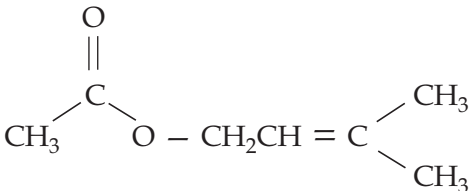
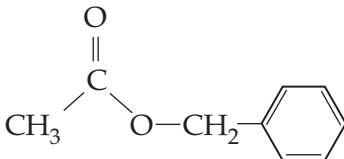
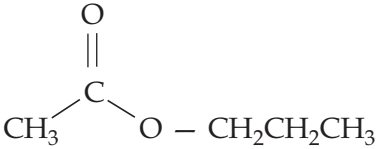
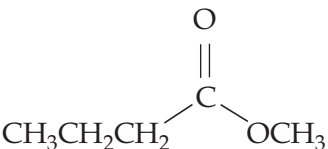
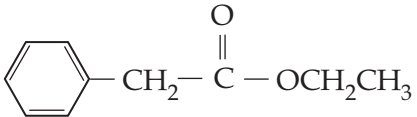
<b>Table 1: Ester Flavours and Fragrances</b>	
 <p><b>Isoamyl acetate</b> banana (alarm pheromone of honeybee)</p>	 <p><b>Ethyl butyrate</b> pineapple</p>
 <p><b>Isobutyl propionate</b> rum</p>	 <p><b>Octyl acetate</b> oranges</p>
 <p><b>Methyl anthranilate</b> grape</p>	 <p><b>Isopentenyl acetate</b> "juicy fruit"</p>
 <p><b>Benzyl acetate</b> peach</p>	 <p><b>n-Propyl acetate</b> pear</p>
 <p><b>Methyl butyrate</b> apple</p>	 <p><b>Ethyl phenylacetate</b> honey</p>

Appendix 5.4: Esters: Flavours and Fragrances (*continued*)

Pure Compounds	%	Essential Oils	%
Allyl caproate	5	Oil of sweet birch	1
Isoamyl acetate	3	Oil of spruce	2
Isoamyl isovalerate	3	Balsam Peru	4
Ethyl acetate	15	Volatile mustard oil	1
Ethyl butyrate	22	Oil cognac	5
Terpinyl propionate	3	Concentrated orange oil	4
Ethyl crotonate	5	Distilled oil of lime	2
Caproic acid	8		
Butyric acid	12		19
Acetic acid	5		
	81		

Although the “fruity” tastes and odours of esters are pleasant, they are seldom used in perfumes or scents that are applied to the body. The reason for this is a chemical one. The ester group is not as stable to perspiration as the ingredients of the more expensive essential oil perfumes. The latter are usually hydrocarbons (terpenes), ketones, and ethers extracted from natural sources. Esters, however, are only used for the cheapest toilet waters, since on contact with sweat, they undergo a hydrolysis reaction to give organic acids. These acids, unlike their

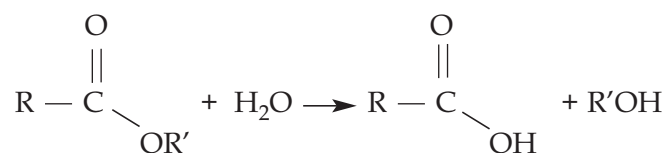

precursor esters, generally do not have a pleasant odour. Butyric acid, for instance, has a strong odour similar to that of rancid butter (of which it is an ingredient) and is, in fact, a component of what we normally call “body odour.” It is this substance that makes foul-smelling humans so easy for an animal to detect when it is downwind of them. It is also of great help to the bloodhound that is trained to follow small traces of this odour. The *esters* of butyric acid, ethyl butyrate and methyl butyrate, however, smell like pineapple and apple, respectively.

A sweet fruity odour also has the disadvantage that it may attract fruit flies and other insects in search of food. The case of isoamyl acetate, the familiar solvent called banana oil, is particularly interesting. It is identical to the alarm *pheromone* of the honeybee. Pheromone is the name applied to a chemical secreted by an organism that evokes a specific response in another member of the same species. This kind of communication is common between insects that otherwise lack means of intercourse. When a honeybee worker stings an intruder, an alarm pheromone,

**Appendix 5.4: Esters: Flavours and Fragrances** (*continued*)

---

composed in part of isoamyl acetate, is secreted along with the sting venom. This chemical causes aggressive attack on the intruder by other bees, which swarm after the intruder. Obviously it wouldn't be wise to wear a perfume compounded of isoamyl acetate near a beehive.

**References**

- Benarde, M.A. *The Chemicals We Eat*. New York, NY: American Heritage Press, 1971. 68-75.
- The Givaudan Index*. New York, NY: Givaudan-Delawanna, Inc., 1949. (Gives specifications of synthetics and isolated perfumery.)
- Gould, R.F., ed. *Flavour Chemistry, Advances in Chemistry No. 56*. Washington, DC: American Chemical Society, 1966.
- Pyke, M. *Synthetic Food*. London, UK: John Murray, 1970.
- Shreve, R.N. *Chemical Process Industries*. 3rd. ed. New York, NY: McGraw-Hill, 1967.

# GENERAL APPENDICES

---

- Appendix 6: Scientific Communication 3
- Appendix 7: Research 11
- Appendix 8: Assessment 17
- Appendix 9: Developing Assessment Rubrics in Science 23
- Appendix 10: Assessment Rubrics 29
- Appendix 11: General and Specific Learning Outcomes 39



## Appendix 6: Scientific Communication

One of the primary skill thrusts of Grade 11 Chemistry is that of providing many opportunities for *scientific communication*. Some of these instances will mimic the behaviours, traditions, and organizational aspects of a *scientific community*. Others are intended to be more authentic and directly promote student-centred development of skills related to the unique demands of communicating scientific ideas and results effectively.

The following strategies can be used in the science classroom to communicate scientific information. For additional information about the strategies, see the following teacher resources:

- *Senior Years Science Teachers' Handbook* (Manitoba Education and Training), abbreviated as *SYSTH*
- *Senior 3 English Language Arts: A Foundation for Implementation* (Manitoba Education and Training), abbreviated as *Senior 3 ELA*

### **Audience (Adaptation for)**

Students adapt information, such as a paragraph in a textbook, for a different audience.

### **Booklet, Brochure, Pamphlet**

Students may present information they have obtained through research or investigation in the form of a booklet, brochure, or pamphlet. This medium is most effective if the information to be represented involves a series of individual steps or points, and includes diagrams or pictures. Students involved in graphic arts may consider this an effective means of communication.

### **Cartoons**

An individual scientific concept, rule (such as a safety rule), or law may be effectively communicated by a cartoon, an illustration, or a series of pictures.

### **Charts**

Information or results that show related tendencies or patterns may be presented best in an organized chart. A flow chart may allow the steps of a process to become more apparent.

### **Concept Overview Frame (See SYSTH 11.25, 11.37)**

After studying a concept, students may fill out a Concept Overview Frame. This will allow them to summarize what they have learned.



### Data Table

Data measured during the course of an investigation are often best organized in a data table. The data table should have a title, labelled rows and columns, and the correct units. It may include several trials and the average values, as well as the equations used (in variable form). The data table should be prepared before the experiment begins.

### Debates (See SYSTH 4.19)

Debates are effective in presenting divergent opinions and attitudes related to STSE issues. The debate usually draws on students' own positions on science-related social issues. Pro and con formats can be used to illustrate the main points and to create a dialectic within the debate. While the scenario is often make-believe, the debate provides a forum for personal commentary. Because students often hold debated opinions with greater personal conviction, the debate must be structured in a manner in which sensitivity to various points of view is accepted, if not agreed upon.

#### Suggested Organization of Debates

1. Select two small balanced groups of students who support divergent and opposing views on a science-related social issue.
2. Provide or have students research background information.
3. Students on each side of the issue prepare and coordinate their evidence to avoid redundant arguments.
4. Select a moderator to monitor time and response to questions.
5. Remind students to listen to and respect divergent points of view. Discourage the notion that only one viewpoint is correct.

### Demonstrations

Demonstration of a technique or a procedure is an effective way to communicate an understanding of the process.

### Diagrams

Visual communication is often more effective than a written description. Labelled diagrams may be useful for showing equipment set-ups, cycles, and so on.

### Dramatic Presentations

Many creative students enjoy dramatizing the information to be presented (such as the history of science) in the form of a skit, a role-play, a play, or a movie. Students must be prepared to research appropriate materials before constructing the dramatic presentation, as this process may be time-consuming. Care must be taken to ensure that students concentrate on the scientific concepts and knowledge, not solely on the dramatization.

## Graphing

Representing data in graphical form helps make the relationship between variables more obvious.

- When planning the graph, students need to consider scale. They determine the maximum values for both axes and make the scale accordingly.
- Students label both the vertical and horizontal axes with the factors being graphed and indicate the units being used.
- If the points indicate a straight line, students may use a straight edge. If a line of best fit is required and calculated on the calculator, students need to represent their calculations accurately.
- In a sentence or two below the graph or within the analysis, students explain the implications or main point revealed by the representation.

## Historical Perspectives

Students communicate information from the perspective of an individual (scientist, layperson) in another time period. They may choose to write an article critiquing an idea that was controversial in its time (such as smallpox vaccination or the Earth's orbit). Students research information and reflect on their response. Variations include responding from a different age or cultural perspective.

## Inquiry or Research Paper Handbook (See Senior 3 ELA 4-270)

Working in groups, students produce a handbook outlining the various stages, processes, and strategies of the inquiry or research process. This handbook is then available as a reference during the course of study, and may be adapted or supplemented as required.

## Journals

A scientific journal is an effective way for students to record thoughts and ideas during the progression of learning. Teachers may ask students to reflect on and respond to particular questions, such as noting their thoughts on a current issue in the newspaper. Alternatively, students may record their thoughts and feelings as they read a certain piece of scientific literature.

## Learning Logs

Students keep an inquiry or research log throughout their inquiry or research project. In this log, students may collect various artifacts representing stages in the research process, as well as record anecdotes of the experience.

## Models

Students may create two- or three-dimensional models of a particular concept, theory, or idea. This may involve the use of materials such as papier mâché or modelling clay.

### **Multimedia Presentations**

Students may choose to communicate their understanding through the use of PowerPoint software, a video, or other types of electronic media.

### **Newspaper Articles**

By writing as reporters from a particular period of a society's history, students may see different perspectives of a scientific issue or idea.

### **Oral Presentations**

Gaining ease, composure, and a public presence while speaking to an audience are skills developed over many years of schooling and extracurricular activity. At certain points in a student's experience, some growth is encouraged in the arena of public oratory. When oral presentations are compulsory for students, teachers are encouraged to exercise caution and discretion. Focusing on these situations as celebrations of learning that students have mastered promotes confidence and success in addressing peers publicly.

### **Posters**

The poster session at scientific meetings has long been a standard in scientific communication, and provides an alternative venue for the presentation of new results to the large-scale public lecture that is not able to engage at a personal level. In a poster presentation, there is ample opportunity to "get close" to the creators of the work, ask questions, point out interesting facets of their work, and offer suggestions for continued efforts.

### **Presentation Software**

Students may use presentation software, such as *PowerPoint*, to present their information. Students must determine which sounds and images are suitable, and enhance communication, as well as learn how to use the program's elements to unify their presentation.

### **RAFT (Role-Audience-Format-Topic and Strong Verb) (See SYSTH 13.23 for Format)**

The RAFT writing assignment is a portfolio strategy designed to produce creative and imaginative writing pieces in science. Through these assignments, students can

- see alternative perspectives on a science topic or issue
- uncover divergent applications of science concepts
- make connections between their world of experience and their science learning (e.g., metaphorical stories)

### Recommendation Report (See Senior 3 ELA 4-270)

Students write a short reflection on the implications of their inquiry findings. In their reflections, students may wish to

- identify subsequent inquiry topics that might grow out of the one they have researched
- suggest how the information gathered in the inquiry could be applied
- recommend action that should be taken to solve a problem
- explore how public awareness could be raised about an issue
- describe how they will think or act differently because of the inquiry

### Role-Playing (See SYSTH 4.18)

Role-playing scenarios teach selected social processes that govern relations, such as negotiation, bargaining, compromise, and sensitivity. Ultimately, students would use these skills as they move from vision to action in dealing with STSE issues. Role-playing often provides an avenue for presenting biased opinions, which may or may not agree with the opinions of students. Most importantly, it introduces divergent points of view and allows students to analyze and respond, thereby giving them an opportunity to gain an appreciation for why individuals hold divergent points of view. Ideally, the role-playing scenario fosters critical-thinking skills while promoting tolerance of other world views. All simulations have rules that govern human interaction. Regardless of the roles assumed, certain behaviours should be promoted, while others should not be allowed.

### Roundtable

A roundtable discussion should engage all students in open scientific discussion. The discussion may be initiated by concepts outlined in a scientific article. The opening question should engage all participants and should be based on the text of the article. Although it is not necessary, the teacher may ask *each* student to respond briefly to the first question to “break the ice.” (Examples of opening questions are: “What is the most important idea in this text? Why?” and “Do you think this text is scientifically valid? Why?”) The core question may be changed during the roundtable discussion to clarify a response or to refocus the group. This question should be focused more directly on the text. (For example: “Why did the scientists use [this animal, technique, equipment]?” or “Explain what the author meant by the word \_\_\_\_\_ in Paragraph 4.”) This question should encourage students to examine how their thinking has changed during the course of the roundtable discussion. The teacher may want to ask questions (such as “How have your answers to the opening question changed?” or “How does the topic relate to your lives?” or “What could be done next?” or “What would you change?”). These questions should not solicit answers to which everyone would agree.

- **Role of Teacher:** The teacher’s role is to facilitate, not validate. Try not to make any response, whether with a facial expression, nod, or frown, that would indicate a right or wrong answer. Ask questions that provoke and take thought to a new level. Remind students to back up thoughts with facts from the document. An idea might be to diagram the seating arrangement, “web” the

responses, and add a word or phrase beside the name of the speaker. This strategy can help

- identify who speaks and how often
- provide cues to additional questions
- keep the teacher from physically affirming responses

If one student appears to monopolize the roundtable, each student may be issued five chips. Each time the student speaks, he or she gives up a chip. Therefore, the student has five opportunities to speak.

- **Role of Student:** Student participation (both speaking and listening) is mandatory. Students need to be courteous and respectful of classmates. They speak without raising their hands, talk to each other, and address the person they are speaking to by name. A roundtable is a way for students to communicate what they think about the document, not what they feel. They should always refer to the text.

### **Scientific Paper (See SYSTH 14.13 for Format)**

At the Senior Years, exposure to the writing of a technical, scientific “paper” is of utmost importance, but it should be treated in an introductory manner. Many students face the reading (or writing) of the scientific paper rather suddenly at the post-secondary level of study, and are ill-prepared for it. In reality, particular scientific journals have their own writing style, format, and so on. No single format or referencing style should be advocated exclusively, but exposure to a few examples is helpful (for instance, using an American Psychological Association [APA] style of referencing versus numerical endnotes).

In the *Senior Years Science Teachers’ Handbook*, teachers are offered some standard, normative samples of the Laboratory Report Format and the Scientific Paper Format (see SYSTH, Chapter 14: Technical Writing in Science, 14.11 to 14.15). Keep in mind that one of the chief purposes of the classical scientific paper is to announce the results of research related to *new contributions* in a field. Consequently, its role and purposes are distinct from that of a research or position paper.

### **Storyboard**

Students could create storyboards to show the development of a scientific concept or theory. Discussion may then centre on the suggestion: “What might have happened if the order of occurrence had been changed?” (changing chronology)

### **Web Page Creation (See Senior 3 ELA 4-168)**

Stages of creating a website may include

- surveying other websites on the same subject
- compiling a list of criteria for an effective website on the chosen subject
- writing a proposal for the website, describing its intended audience and purpose
- using a flow chart for constructing a personal website or contributing to the school’s website

**Word Cycle, Word Glossary (See SYSTH 10.21)**

A Word Cycle is considered a Level 1 strategy in building a scientific vocabulary (for instance, see *SYSTH*, Chapter 10: Building a Scientific Vocabulary). The value in using a Word Cycle comes from taking a broad concept such as an ecosystem, providing a list of terms that could be related to that concept, and then asking students to link these words coherently. Students then learn how terminologies are related, broaden meaning of terms, and promote collaboration. Teachers are encouraged to use Word Cycle activities with their students in a cooperative manner (e.g., pairings).

A Word Glossary, steadily accumulated over time, is a useful way for students to organize the large number of terms that science topics bring forth. Pay close attention to the repetitive use of prefixes (e.g., neuro-) and suffixes (e.g., -logical) in scientific parlance.

**Written Lab Report (See SYSTH 11.38, 11.39, 14.12)**

There are a variety of formats for lab reports within a common framework. A lab report may contain the following information:

- **Abstract/Introduction:** A condensed version of the entire paper, placed at the beginning of the report. The material in the abstract is written in the same order as it appears within the paper, and should include a sentence or two summarizing the highlights from each section. The abstract is written once the paper is complete.
- **Purpose/Objective/Problem:** A brief statement of the purpose or objective of the experiment.
- **Background Information:** Information drawn from research.
- **Pre-Lab Theory:** The posing of a theoretical solution to the problem before the experimental procedure. It may involve a conceptual explanation and mathematical calculations.
- **Hypothesis:** Contrary to the persistent myth, a hypothesis is not an “educated guess” about what will happen. A statement such as “cigarette smoking causes cancer” is a hypothesis because it is a statement of suggested behaviour in the material world that is *testable* by scientific means. A hypothesis intends to make a *contingent claim* based on prior accepted models about how the world works. The claim, then, is subject to testing over and over again. It is the task of the investigation procedure either to support or to nullify the hypothesis statement.
- **Variables:** For the purposes of this curriculum, anything that comes in different types or different amounts and could possibly enter into an investigation. The simplest sort of relationship to examine is that between two variables (e.g., a person’s height and arm span). It is not always a simple task, however, to *control* all the variables that may confound a scientific investigation.
- **Materials:** A list of the materials to be used in the experiment and a labelled diagram of equipment set-up, if applicable.

- **Procedure:** Written step-by-step directions for performing the experiment and regulating the controls, and a summary of the steps taken, so that someone who has not performed this lab would be able to repeat it. If a mixture is heated, the temperature should be given. Any modifications to the procedure should be noted. When following a procedure from a secondary source, reference should be given for the source.
- **Results:** Include drawings, measurements, averages (if applicable), observations, data tables, calculations, and graphs.
- **Observations:** Qualitative interpretations of what is occurring during the course of an experiment. Examples include colour changes, odour, formation of a precipitate, release of gas, temperature differences, pressure changes, or changes in solubility.
- **Quantitative Data:** Measurements taken directly from laboratory instruments. Data must be collected with care during the experiment, properly identified, and the correct numerical values and units used. Suspected faulty data must be presented and explained in the conclusions if not used in the analysis.
- **Sample Problems:** Show the conversion of data into results. Calculations should be properly labelled, with the accuracy and precision of the instruments taken into consideration, and the correct number of significant figures used.
- **Analysis:** An important part of the report that demonstrates an understanding of the experiment. It contains an interpretation or explanation of results, indicating their significance, how accurate the original hypothesis was, sources of error and their effect on results. The analysis also indicates ways to improve the experiment, including modifying the procedure, the equipment, the variables, and so on. The analysis can relate results to the real world and may describe a follow-up or auxiliary experiment.
- **Conclusions:** A summary of results and whether the purpose of the experiment has been achieved. Readers often read the conclusion first.

### **Zines** (See Senior 3 ELA 4-166)

Zines (or fanzines, or mini-magazines) usually treat a particular theme. Components may include

- cartoon
- collage
- editorial
- interview
- memoir
- poem
- review
- survey results

## Appendix 7: Research

Learning through student-directed or student-initiated projects is known to be a highly effective pathway to promote individualized instruction or to make the best use of the diversity within the classroom. The inquiry approach advocated in Grade 11 Chemistry presupposes that students will have ample opportunity to develop and refine their research skills through gathering, filtering, processing, and evaluating scientific information.

The following learning strategies can be used in the science classroom to help students develop research skills and strategies. For additional information about the strategies, see the following teacher resources:

- *Senior Years Science Teachers' Handbook* (Manitoba Education and Training), abbreviated as *SYSTH*
- *Senior 3 English Language Arts: A Foundation for Implementation* (Manitoba Education and Training), abbreviated as *Senior 3 ELA*

### Action Plan (See *Senior 3 ELA 4-216* for Whole-Class Inquiry)

Students may submit action plans for group inquiries that include the following components.

Group Inquiry Action Plan					
Objectives	Strategies	Responsibilities	Timelines	Results	Resources

### Concept Maps (See *SYSTH 9.6, 11.7, 11.8, 11.11*)

A Concept Map is intended to help students identify key vocabulary for a topic or identify the relationships between terms in a topic. The teacher may model this procedure by arranging pieces of paper with key terms to show the relationships or logical connections between them. Concept Maps may follow a category, a chain, or a hierarchy as an organizational strategy.

### Email

The teacher can arrange links with schools, universities, or other research facilities in other parts of Canada or the world to have students carry out parallel research and to share and discuss data through email.

### Interviews (See *Senior 3 ELA 4-240, 4-226*)

Students may analyze models of interviews and practise with peers before conducting interviews in the community. It may be useful to have a preliminary interview in which students introduce themselves, describe the topic and purpose, ask the interviewee what information or experience he or she is able to relate on the



topic, explain how the interview will be conducted and how the information will be used, and discuss the time, length, and place of the interview.

### Literature-Based Research Projects (See SYSTH 4.7)

A literature-based research approach can be applied to many STSE topics. A series of questions can direct students during their topic research. Students with competent literature research skills will be able to

- locate and analyze the validity of scientific information
- reduce unnecessary duplication of laboratory investigations
- recognize multiple perspectives from various interest groups
- determine how decisions are made at the local, provincial, and federal levels of government
- examine scientific, environmental, technological, societal, and economic sides of an issue

Teachers should model the five stages of effective research: planning, information retrieval or gathering, information processing, information sharing, and evaluation.

### Plagiarism (Avoidance of) (See Senior 3 ELA 4-260)

Teachers use direct instruction to teach students the conventions for summarizing, paraphrasing, and quoting from research materials. To avoid plagiarism, students need opportunities for supervised practice in using secondary sources appropriately in their research.

<b>Three Ways to Use Secondary Sources (Student Handout)</b>
<ul style="list-style-type: none"> <li>• <b>Summaries:</b> Summarize general information as you proceed with your research. General information consists of facts and concepts that are generally known and that appear in several sources. If you cannot judge whether information is generally known or is the property of one writer, you need to read several more sources. When you write your own text, synthesize the facts and concepts from these summaries in your own words. This information does not need to be referenced.</li> <li>• <b>Paraphrases:</b> Paraphrase ideas and statements that belong to one writer, but that you do not wish to quote. To paraphrase, restate the ideas in a passage in your own words. You may need to use common words that appeared in the original, but do not repeat striking words or unique phrases that can be recognized as the style of the original writer. Reference the source of this material. It is considered good style to name the original writer in your paraphrase (e.g., Eldon Craig argues that the hog-nosed snake is a newcomer to Manitoba prairies.).</li> <li>• <b>Quotations:</b> Quote striking or powerful lines that would lose their impact if they were paraphrased. Take care to quote lines accurately, and ensure that you do not lose or change their meaning by taking them out of their original context. Make arguments in your own words, and support them with a quotation rather than using quotations to make key arguments. Name the speaker or writer you are quoting, enclose the quoted material in quotation marks, and reference the source of the quotation.</li> </ul>



---

**Plagiarism (Avoidance of):** Adapted from Section 4-260 of *Senior 3 English Language Arts: A Foundation for Implementation*. Copyright © 1999 by Manitoba Education and Training.

A form such as the following can help students distinguish between material cited directly and their own paraphrases, summaries, and comments.

<b>Form for Recording Information</b>	
Author's name: (last) _____ (first) _____ Title of source: _____ Place of publication: _____ Publisher: _____ Year of publication: _____	
<p><b>Summaries:</b> Briefly note the main ideas of the whole text.</p>	<p><b>Paraphrases:</b> Write important and supporting information in your own words. Record the page number(s).</p>
<p><b>Comments:</b> Record your own responses to questions about what you read.</p>	<p><b>Direct Quotations:</b> Record only passages that you are very likely to quote in your final article. Record the page number(s).</p>

**Proposals (See Senior 3 ELA 4-221)**

Students may submit proposals for major group projects. Depending on the project, the proposal may include the following categories:

- Purpose
- Audience
- Outline
- Resources
- Team Members and Their Responsibilities
- Steps in Research
- Risk Factors and Plans for Addressing Them
- Form for Reporting
- Timelines
- Progress Reports
- Criteria for Success

**Reading Scientific Information (See SYSTH, Chapter 12)**

Chapter 12 of *SYSTH* presents strategies to help students acquire the skills they need to comprehend science texts and scientific information accessed from multimedia sources. Students use interactive and collaborative strategies to understand and learn the content.

Good readers begin by skimming and analyzing a text and providing themselves with a structural and conceptual framework into which new information might fit. They then read for detail, with three levels of comprehension: literal understanding, interpretation, and application.

Students will be able to become better readers if teachers divide reading exercises into three sections:

- **Pre-reading:** Pre-reading strategies are intended to establish a purpose or focus, to activate prior knowledge, to emphasize new terms and vocabulary, or to provide familiarity with text features.
- **During-reading:** During-reading strategies are meant to promote collaboration, to help students recognize text structure, or to promote questioning and paraphrasing.
- **Post-reading:** Post-reading strategies are designed to teach students how to apply content by increasing comprehension and recall, connecting details to the big picture, making new connections, applying ideas, and transferring knowledge.

Various strategies are developed in *SYSTH*.

**Surveys and Questionnaires** (See Senior 3 ELA 4-226, Appendix C)

Students may submit a proposal for a survey or questionnaire in which they describe

- type of information they wish to gather
- type of survey they intend to implement
- target group and plan for random sampling
- how and when they will pilot the survey
- how and when they will administer the survey
- how they will analyze, interpret, and report data

Surveys are a useful tool for collecting information, particularly on timely, community-based inquiry topics. The following should be considered when designing and conducting a survey:

- Purpose
- Appropriateness
- Practicality
- Clarity
- Reliability
- Target Group
- Sample
- Random Selection

Types of surveys include fixed-response questions (multiple choice, agree-disagree, checklists), rating scales (numerical, categorical), open-ended, and phenomenological (extended interview). Students may choose to pilot their survey before administering it.

**WebQuest**

A WebQuest is an inquiry-oriented activity in which most or all of the information used by learners is drawn from the Web. WebQuests are designed to make efficient use of time, to focus on using information rather than looking for it, and to support learners' thinking at the levels of analysis, synthesis, and evaluation.

A basic WebQuest design includes an introduction, a task, a set of information sources needed to complete the task (not all sources need to be web-based), a description of the process in clear steps, guidance (such as guiding questions, timelines, Concept Maps), and a conclusion. WebQuest design information, templates, and samples may be obtained at *The WebQuest Page*:  
<<http://webquest.sdsu.edu/>>.



## NOTES

## Appendix 8: Assessment

---

For the purpose of this curriculum, assessment is the systematic process of gathering information about what a student knows, is able to do, and is currently *learning to do*. Science education today, therefore, demands a broad range and variety of assessment tools to gauge student learning. An inclusive classroom will encourage, whenever possible, assessment opportunities that provide *all students* with the chance to demonstrate what they know *most of the time*.

This appendix provides an overview of various assessment perspectives intended to promote fair assessment and evaluation and increase students' role and responsibility in their own ongoing assessment. Some actual assessment instruments that are proving to be effective in today's classrooms are also included.

Teachers are encouraged to review the *Senior Years Science Teachers' Handbook* (see *SYSTH*, Chapter 15: Assessing and Evaluating Science Learning). Further information is also provided in *Senior 3 English Language Arts: A Foundation for Implementation* (Manitoba Education and Training), abbreviated as *Senior 3 ELA* on the following pages.

### **Concept Relationship Frame (See SYSTH 11.20, 11.25, 11.35)**

This differentiated instruction technique is designed to help students examine particular, detailed associations between two concepts (i.e., cause/effect, problem/solution, either/or, compare/contrast). The aim is to avoid superficial analysis by probing for deeper associations. Chapter 11: Developing Science Concepts Using Graphic Displays in *SYSTH* demonstrates how the Concept Relationship Frame can be used effectively.

### **Developing Assessment Rubrics in Science (See Appendix 9)**

Appendix 9 outlines various ways in which students can be engaged with their teachers in the development of assessment rubrics. It addresses questions such as the following:

- What are assessment rubrics?
- Why do teachers use assessment rubrics?
- How can assessment rubrics enhance instruction?
- What are some sources of rubrics? Sources include classroom-developed, teacher-developed, and externally developed rubrics.

**Journal Writing and Assessment (See SYSTH 13.21)**

Journal writing is a *writing to learn* strategy that engenders mixed feelings among students. Part of the “uncertainty” comes from the inability to be passive about one’s learning if one is asked to comment upon it, write carefully about it, or be reflective about it. Journals should have an *informal*, familiar tone but should not be quaint or dismissive. Journal entries can be simple and short, vary in frequency, and be structured to a particular format or free-form. It is valuable to consider how best to use journal writing in the science classroom, but experience shows that overuse defeats the purposes of the journal. For instance, if journal writing has little or no assessment/evaluation potential toward a student’s grade, or does not provide a means of obtaining teacher feedback, it is difficult to sustain a successful experience.

Establishing a dialogue with students is an important element of formative assessment. Teachers may respond to students’ journal entries, extending student thinking through comments and questions. In assessing journal entries, teachers may look for different interpretations and consideration of different perspectives, analyses, and growth.

**Laboratory Report Assessment (See Appendix 10)**

The Lab Report Assessment rubric is designed for both self-assessment and teacher assessment, and includes criteria such as the following:

- Formulates Testable Questions
- Formulates a Prediction and/or Hypothesis
- Creates a Plan
- Conducts a Fair Test and Records Observations
- Interprets and Evaluates Results
- Draws a Conclusion
- Makes Connections

**Observation Checklist: Scientific Inquiry—Conducting a Fair Test  
(See Appendix 10)**

This rubric is designed with five performance criteria, and can be used for an entire class list. The emphasis is on gathering information over time through observation. The criteria include the following:

- Demonstrating Safe Work Habits
- Ensuring Accuracy and Reliability
- Observing and Recording
- Following a Plan
- Showing Evidence of Perseverance and/or Confidence

**Peer Assessment (See Senior 3 ELA 4-307)**

Peer conferences could be organized to allow peers to act as problem solvers who offer concrete suggestions. The teacher may choose to provide students with questions and prompts. For instance, if students are editing a research paper, the peer assessment may include the following questions:

- Does the text contain enough information?
  - Pose questions that are not answered.
  - Mark passages that require more information.
- Is the text well organized?
  - Use arrows to show suggested reordering of paragraphs.
  - Mark places where a transition is required.
- Is the text clear?
  - Mark passages that are clear.
  - Mark words or phrases that need to be explained or defined.
  - Mark passages that need charts, graphs, diagrams, or examples.
- Is the information communicated in an interesting way?
  - Mark the least and most interesting sections.
- Are the sources referenced?
  - Mark un-referenced information.
  - Suggest other sources that may be used.

**Performance Assessment**

Performance assessment may take the form of

- demonstrating a lab technique (e.g., lighting a Bunsen burner, using a balance, focusing a microscope)
- demonstrating a safety procedure
- interpreting Workplace Hazardous Materials Information System (WHMIS) labels
- identifying an unknown

**Portfolios (See Senior 3 ELA 4-180)**

Portfolio items that allow students to demonstrate attainment of specific learning outcomes include

- inquiry logs
- project proposals
- webs and maps
- samples of notes
- reports on primary research
- reflective pieces



### **Reading Scientific Information (Concept Map Evaluation) (See SYSTH 12.15 to 12.19)**

Chapter 12: Reading Scientific Information of *SYSTH* suggests techniques for comprehending science texts. It includes examples of how students could take notes from text in the manner of a detailed Concept Map organizer (see 12.16) and how this strategy can connect to *reading for meaning*. Once teachers have effectively modelled the techniques and students have had ample time to practise with scientific reading skills and note-taking, some criteria can be established that can be used in evaluation (see 12.19).

### **References**

Students hand in a preliminary list of references as part of their proposal for a research paper.

### **Rubric for Assessment of Class Presentation (See Appendix 10)**

This rubric is designed with four performance levels, and includes assessment criteria such as the following:

- Content
- Interest and Enthusiasm
- Clarity and Organization of Materials
- Use of Visual Aids

### **Rubric for Assessment of Research Project (See Appendix 10)**

This rubric is designed with four performance levels, and includes criteria such as the following:

- Source of Information
- Information Collected
- Organization of Material
- Presentation of Material

### **Rubric for Assessment of Scientific Inquiry (See Appendix 10)**

This rubric is designed for guidance of student assessment in relation to the performance of *scientific inquiry tasks*. The rubric is not intended to be comprehensive, but seeks to provide some project-management parameters for teachers who are observing their students' initial attempts at sophisticated investigation work.

The rubric is designed around four levels of competency, as continua, and includes criteria in the following areas:

- Development of a Position Statement (Proto-Abstract)
- Objective/Purpose/Testable Question
- Procedure (design of the investigation)
- Data Collection
- Analysis and Interpretation of Results
- Application/Discussion of Scientific Results and Concepts
- Independence Factors (measuring degree of reliance upon outside assistance)

### **Self-Assessment**

Self-assessment by students is integral to the overall assessment of learning. To assess their own work, however, students require some detailed advance knowledge (e.g., criteria) of what the expectations are. More advanced learners in this self-reflection process can then participate in setting criteria with their teacher(s). Teachers are encouraged to model self-assessment before expecting students to assess themselves.

### **Word Cycle (See SYSTH 10.6 to 10.8, 10.21)**

A Word Cycle is considered a Level 1 strategy in building a scientific vocabulary (see *SYSTH*, Chapter 10: Building a Scientific Vocabulary). The value in using a Word Cycle comes from taking a broad concept such as an ecosystem, providing a list of terms that could be related to that concept, and then asking students to link these words coherently. Students then learn how terminologies are related, broaden the meaning of terms, and promote collaboration. Teachers are encouraged to use Word Cycle activities with their students in a cooperative manner (e.g., pairings).

## NOTES

## Appendix 9: Developing Assessment Rubrics in Science

### The Nature, Purposes, and Sources of Assessment Rubrics for Science

#### What Assessment Rubrics Are

Rubrics are assessment tools that identify criteria by which student processes, performances, or products will be assessed. They also describe the qualities of work at various levels of proficiency for each criterion.

The following types of assessment rubrics may be used in classroom assessment:

- **General rubrics** provide descriptions of proficiency levels that can be applied to a range of student processes, performances, or products. Using the same rubric for similar tasks helps teachers manage marking assignments based on student choice. It also helps students internalize the common qualities of effective processes, performances, and products.
- **Task-specific rubrics** describe the criteria used in assessing specific forms, such as using a balance, writing a laboratory report, or calibrating CBL probes. Complex student projects may require a different rubric for each phase (for example, a group inquiry project may require a rubric for collaborative work, information-gathering processes, oral presentations, and written reports).
- **Holistic rubrics** are used to assign a single mark to a process, performance, or product on the basis of its adequacy in meeting identified criteria.
- **Analytic rubrics** are used to assign individual scores to different aspects of a process, performance, or product, based on their specific strengths and weaknesses according to identified criteria. See the Rubric for Assessment of Decision-Making Process Activity in Appendix 10.
- **Checklists** are lists of criteria that do not distinguish levels of performance. They are used to assess the presence or absence of certain behaviours, and are most suitable for assessing processes (for example, “Did the student perform all the necessary steps?”). Because they require “Yes/No” judgements from the assessors, checklists are easy for students to use in peer assessment.
- **Rating scales** ask assessors to rate various elements of a process, performance, or product on a numerical scale. They do not provide complete descriptions of performance at various levels.

#### Why Teachers Use Assessment Rubrics

The best assessment tasks ask students to perform the sorts of scientific literacy tasks they will be called upon to perform in real-world situations. They allow students to demonstrate not only the declarative knowledge they have gained, but also the interplay of attitudes, skills, and strategies that constitute their learning.

---

**Developing Assessment Rubrics in Science:** Adapted from Appendices-3 to -10 of *Senior 3 English Language Arts: A Foundation for Implementation*. Copyright © 1999 by Manitoba Education and Training.

Authentic assessment tasks invite a range of responses and allow students to express their individuality. For all these reasons, assessing scientific literacy is a complex matter.

Assessment rubrics

- help teachers clarify the qualities they are looking for in student work
- ensure that all students are assessed by the same criteria
- help teachers communicate the goals of each assignment in specific terms
- allow teachers within schools, school divisions, and the province to collaborate in assessment
- play an important part in instruction

### **How Assessment Rubrics Enhance Instruction**

The best assessment tools do not simply sort and score student work; instead, they describe it in specific terms. This assessment information

- helps teachers adjust instruction to meet student learning requirements
- tells students what teachers expect and will look for in their work, and helps them to focus their efforts
- allows students to assess their own work using the criteria teachers will use to set goals and to monitor their progress
- aids in the development of metacognition by giving students a vocabulary for talking about particular aspects of their work

### **Sources of Assessment Rubrics**

Teachers develop assessment rubrics in collaboration with students, on their own, and/or with other teachers, or obtain them through published sources.

- **Classroom development:** Developing assessment rubrics in collaboration with students can be a time-consuming process, but one that has many benefits in instruction and learning. (Both the benefits and the process are explored on the following pages.) Although it may not be possible to involve students in the process in every instance, their experience in developing rubrics will help students to use ready-made rubrics with more understanding.
- **Teacher-developed:** Teachers develop general performance and product rubrics individually in collaboration within a school or school division. Rubrics must be adapted regularly to reflect student performance levels accurately. It is important that teacher-developed rubrics use language that students understand, and that teachers provide an example of work at each level of proficiency. These examples (called anchors or exemplars) illustrate for students the descriptive phrases used in the rubrics.
- **Published sources:** High-quality assessment rubrics are available in various educational resources. The disadvantage of ready-made rubrics is that they may not be congruent with the learning outcomes targeted in a particular assignment, and may not accurately describe Grade 11 performance levels and criteria.

## Developing Rubrics in Collaboration with Students

### Student Benefits

Developing rubrics in collaboration with students requires them to look at work samples, and to identify the attributes that make some samples successful and others unsuccessful. Teachers assist students by providing them with the vocabulary to articulate the various elements they see, and by ensuring that the criteria are comprehensive and consistent with learning outcomes. This collaborative process in developing rubrics

- requires students to make judgements about the work they see, and to identify the qualities of effective writing, speaking, and representing of science concepts
- results in an assessment tool that students understand and feel they own—they see that assessment criteria are not arbitrary or imposed, but rather express their own observations about what constitutes quality work

### The Development Process

For their first experience in designing a rubric, ask students to articulate the criteria they use in making judgements about something in everyday life—the quality of a restaurant, for example. The model rubric that they develop for assessing restaurants may help students grasp how the parts of a rubric work.

Students may also find it helpful to develop rubrics after they have done some preliminary work on the assessment task, and so are familiar with the demands of the particular assignment.

The process of developing assessment rubrics in collaboration with students involves numerous steps.

#### *1. Look at student work samples.*

Develop assessment rubrics by analyzing genuine samples of student work that illustrate the learning outcomes that the assessment task in question addresses. Samples are usually drawn from student work from previous years, used with permission and with names removed. Beginning teachers who do not have files of samples may need to borrow from colleagues.

Select samples that are clear and characteristic of student work at various levels. Streamline the process by distributing examples at only three levels of proficiency: excellent, adequate, and inadequate. Provide two or three examples of each level. Allow students time to read the examples and to talk about them in groups.

#### *2. Describe the work samples.*

Suggest that students focus on the examples of excellent work first. Pose the question: “What makes this piece successful?” Then ask students to brainstorm attributes of, or criteria for, success. Some of the attributes students list will describe behaviours that are useful in meeting the goals of the work (for example, the topic is stated at the beginning, there are few spelling errors, a graph is used to represent statistical findings).

What rubrics must attempt to articulate, beyond identifying these behaviours, is the essence of a good product or performance. As Wiggins points out, eye contact may be important in the delivery of an oral report, but it is possible to give a dreary talk while maintaining eye contact (V1-5: 6). Together with students, identify the salient qualities of works related to science that are engaging and effective. These may be qualities that are harder to define and illustrate (for example, the speaker has moved beyond a superficial understanding of the subject, the producer of a video is aware of the audience, the writer's voice is discernible in a science journalism piece).

### 3. *Develop criteria categories.*

From the brainstormed list of attributes, select the criteria categories that will make up the assessment rubric. Most rubrics are limited to three to five criteria categories. A greater number makes the rubrics difficult for assessors to use, especially in assessing live performances. Listing too many criteria can also overwhelm or confuse students who use the rubrics for self-assessment and setting goals.

Develop criteria categories by combining related attributes and selecting three to five that are considered most important. Label the criteria categories in general terms (organization, style, content) and expand them by listing the specific elements to be examined in assessing quality in these criteria (for example, in the "organization" category, the elements may be statement of purpose, topic sentences, transition words and phrases, paragraph breaks, order of ideas).

Ensure that no essential attribute that defines good performance is left out. This means including elements considered hard to assess (such as style or creativity). Ignoring elements such as these signals that they are not important. Addressing them helps students grasp the things they can do to improve their own work in these areas. If graphical analysis is identified as one criteria category, for example, the rubric may list elements that convey the details of such an analysis (for example, placement of dependent and independent variables, placement of data points, line of "best fit"). It may also provide definitions.

As students collaborate to develop criteria categories, monitor whether the criteria chosen are related to the intended learning outcomes.

### 4. *Decide how many performance levels the rubric will contain.*

The first rubric students develop will have three performance levels, based on identifying student work samples as excellent, adequate, or inadequate. In later rubrics, students may move to finer distinctions between levels. The number of levels needed to make meaningful judgements regarding the full range of proficiency is best decided by the teacher. If the scale is large (seven levels, for example), finer distinctions can be made, but it may be difficult to differentiate clearly one level from the next. In science, assessment rubrics designed to be

used by students as well as teachers generally use three, four, or five performance levels.\*

Using the same number of performance levels for various tasks throughout the curriculum has the advantage of giving students and the teacher a common vocabulary in talking about ways to improve performance (for example, “This piece does not have the concrete detail of level 4 writing.”). Once the number of criteria categories and performance levels has been determined, a rubric template such as the following can be used in developing rubrics.

		Criteria Categories			
Performance Levels	1				
	2				
	3				
	4				
	5				

#### 5. Describe the performance levels.

In developing the assessment criteria (step 3), students analyze successful pieces of work. They now fill in descriptions of excellent, adequate, and inadequate performance in all criteria categories.

There are two ways of describing performance levels:

- **Evaluative rubrics** use comparative adjectives (for example, “weak organization”).
- **Descriptive rubrics** specify the qualities of work at each performance level with respect to the criteria (for example, “unconnected ideas appear in the same paragraph”). The attributes listed may be negative (for example, “subscripts and coefficients are incorrectly applied”), for sometimes the most telling characteristic of certain levels is their failure to do what they should be doing.

Descriptive rubrics have many advantages over evaluative rubrics. They are more helpful to students because they spell out the behaviours and qualities students encounter in assessing their own and others’ work. They also help students identify the things they can address in their own work in order to improve.

\* Many designers of rubrics advocate a five-level scale. Levels 1, 3, and 5 are developed from an initial sorting of student work into excellent, adequate, and inadequate samples. Levels 2 and 4 describe work that is between these anchor points. Other educators argue that an even-point scale (four or six levels) forces more care in judging than an odd number does; it prevents assessors from overusing a middle category for work that is difficult to assess.



When beginning to write descriptive rubrics, students may suggest generally descriptive adjectives (such as “interesting,” “boring”), which may not convey information about what an interesting piece looks like, and how they can improve their work in this area. The description needs to state the attributes that make a work interesting, and should be written in an acceptable style for scientific communication. Classes may need to begin by using comparative language or general descriptions. As the students and teacher collect examples, they can fine-tune the rubric with specific descriptions.

By the end of this step, students will have a description of performance at three levels. If the class has decided to create a rubric with four, five, or six performance levels, it may be most efficient for the teacher to draft gradations of quality for the middle levels, and present them to the class for revision. These middle levels are the most difficult to write, and call on more experience and expertise in developing a smooth continuum of proficiency.

**6. *Use the assessment rubric for student self-assessment, for teacher assessment, and for instruction.***

Before using the rubric on an actual assignment, students and the teacher may want to test it against unsorted samples of work from previous years. Applying the rubric to student work helps the class determine whether the rubric accurately describes the qualities of the work they see, and helps students make meaningful distinctions between work at different levels of proficiency. As students become more adept at using the rubric, and when they have internalized the performance levels, the teacher can present them with more diverse samples and assessment challenges.

Rubrics make it possible for students to assess their own work on the basis of the criteria that the teacher will use. Any differences in scores between a student’s and a teacher’s assessment can be the subject of profitable and focused discussion in student conferences.

If numerical scores are required, point values assigned to each level can be totalled. If the teacher and students decide that certain criteria categories should be more heavily weighted than others, the points assigned to these categories can be multiplied by a factor.

A rubric developed collaboratively can also become a valuable instructional tool, encouraging students to look closely at the specific things they can do to improve a piece of work. If students decide that a writing sample in science is at level 3, for example, they can be asked to work together in groups to improve the work so that it fits the description for level 4.

**7. *Continue to revise the assessment rubric.***

Any assessment rubric can be considered a work in progress, especially if it is stored on the computer. Both the teacher and students should carefully review the rubric each time they use it, asking, “Do these criteria capture the most important qualities of excellence in this work?” “What other words and phrases can we use to describe work at this level?” In keeping with this, the rubrics appearing in Appendix 10 of this document are intended as templates, open to situational revisions.

## Appendix 10: Assessment Rubrics

## Rubric for Assessment of Research Project

Student Name(s) _____ Topic/Title _____		Performance Levels			
		Level 1	Level 2	Level 3	Level 4
Criteria					
Source of Information	<input type="checkbox"/> Only one source of information was used.	<input type="checkbox"/> Two sources of information were used.	<input type="checkbox"/> A variety of sources was used.	<input type="checkbox"/> A wide variety of sources was used in a unique manner.	
Information Collected	<input type="checkbox"/> The information collected was not relevant.	<input type="checkbox"/> The information collected was relevant to the topic but was not blended into a cohesive piece of research.	<input type="checkbox"/> The information collected was relevant to the topic and was somewhat organized into a cohesive piece of research.	<input type="checkbox"/> The information collected was relevant to the topic and was carefully organized into a cohesive piece of research.	
Organization of Material	<input type="checkbox"/> The information collected was not organized.	<input type="checkbox"/> The information was somewhat organized.	<input type="checkbox"/> The information was organized and contained recognizable sections.	<input type="checkbox"/> The information was organized and contained recognizable sections that included an introduction, a main body with supporting evidence, and a conclusion that summarized the report.	
Presentation of Material	<input type="checkbox"/> The report was handwritten, contrary to established guidelines.	<input type="checkbox"/> The report was neatly handwritten. <input type="checkbox"/> The report contained a bibliography that was not correctly formatted.	<input type="checkbox"/> The report was typed. <input type="checkbox"/> The report contained graphics. <input type="checkbox"/> The report contained a bibliography that was not correctly formatted.	<input type="checkbox"/> The report was typed and appropriately formatted. <input type="checkbox"/> The report contained a title page. <input type="checkbox"/> The report contained relevant graphics. <input type="checkbox"/> The report contained a complete, correctly formatted bibliography.	

*Note: This rubric would vary, depending on the assignment and the presentation format.*

## Rubric for Assessment of Decision-Making Process Activity

Student Name(s) _____		Topic/Title _____			
Criteria	Performance Levels				
	Level 1	Level 2	Level 3	Level 4	
Identifies STSE Issue	<input type="checkbox"/> Cannot identify an STSE issue without assistance.	<input type="checkbox"/> Shows a basic understanding that an issue could have STSE implications, but does not necessarily differentiate among the areas.	<input type="checkbox"/> Shows a good understanding of a connection between an issue and its STSE applications. <input type="checkbox"/> Shows some awareness of the need for an individual response.	<input type="checkbox"/> Demonstrates excellent depth and sensitivity in connecting an issue with its STSE implications. <input type="checkbox"/> Demonstrates a level of social responsibility.	
Evaluates Current Research on Issue	<input type="checkbox"/> Is able to access a small amount of current research but does not evaluate it.	<input type="checkbox"/> Demonstrates some ability to recognize the positions taken in the research data but makes no clear evaluative statements.	<input type="checkbox"/> Secures an array of research, narrow in its scope, but clearly identifies the positions taken. <input type="checkbox"/> Can offer personal opinions on issue but not necessarily an evaluation.	<input type="checkbox"/> Acquires research that is current, relevant, and from a variety of perspectives. <input type="checkbox"/> Demonstrates insight into the stated positions and can frame an evaluation.	
Formulates Possible Options	<input type="checkbox"/> Is unable to identify the possible options clearly. <input type="checkbox"/> Can formulate options that are not clearly connected to the problem to be solved.	<input type="checkbox"/> Offers at least one feasible option that is connected to the problem. <input type="checkbox"/> Offers other options that may be somewhat related to the problem.	<input type="checkbox"/> Develops at least two feasible options that are internally consistent and directly address the problem. <input type="checkbox"/> Recognizes that some options will fail.	<input type="checkbox"/> Displays a sophisticated understanding of feasible options that is beyond expectations. <input type="checkbox"/> Presents choice of options that demonstrate a reasonable chance of succeeding.	
Identifies Projected Impacts	<input type="checkbox"/> Is unable to foresee the possible consequences of the options selected. <input type="checkbox"/> Appears to have a naive awareness of consequences.	<input type="checkbox"/> Identifies potential impacts of decisions taken in a vague or insubstantial way. <input type="checkbox"/> Views most of the feasible options as having projected impacts.	<input type="checkbox"/> Identifies potential impacts of decisions taken in an organized way. <input type="checkbox"/> Views all the feasible options as having projected impacts: some beneficial, some not.	<input type="checkbox"/> Offers a cost/benefits/risks analysis of each feasible solution. <input type="checkbox"/> Constructs an organized report that clearly outlines the impacts of each option.	

(continued)

## Rubric for Assessment of Decision-Making Process Activity (continued)

Student Name(s) _____		Topic/Title _____			
Criteria		Performance Levels			
		Level 1	Level 2	Level 3	Level 4
Selects an Option and Makes a Decision	<ul style="list-style-type: none"> <li><input type="checkbox"/> Is unable to come to a decision that clearly connects with the problem to be solved.</li> <li><input type="checkbox"/> Requires direction from the outside to make a choice.</li> </ul>	<ul style="list-style-type: none"> <li><input type="checkbox"/> Identifies a feasible option, but cannot clearly decide on a plan.</li> <li><input type="checkbox"/> Requires outside influences to stand by a decision to proceed.</li> </ul>	<ul style="list-style-type: none"> <li><input type="checkbox"/> Clearly selects an option and decides on a course of action, but others can identify that a better course of action remains untried.</li> <li><input type="checkbox"/> Recognizes potential safety concerns.</li> </ul>	<ul style="list-style-type: none"> <li><input type="checkbox"/> Thoroughly analyzes all options collaboratively.</li> <li><input type="checkbox"/> Makes firm decision, justified by the research base, and recognizes most of the safety concerns.</li> </ul>	
Implements the Decision	<ul style="list-style-type: none"> <li><input type="checkbox"/> Is unable to implement the decision fully, but has an opportunity to modify it.</li> <li><input type="checkbox"/> Lacks the clarity to proceed.</li> </ul>	<ul style="list-style-type: none"> <li><input type="checkbox"/> Implements the decision with a recognition that not all details are laid out in advance.</li> <li><input type="checkbox"/> Lacks clarity in having a plan for implementation.</li> </ul>	<ul style="list-style-type: none"> <li><input type="checkbox"/> Implements the decision with some clarity of purpose.</li> <li><input type="checkbox"/> Demonstrates confidence that the implementation plan can follow a scientific inquiry approach.</li> </ul>	<ul style="list-style-type: none"> <li><input type="checkbox"/> Implements the decision with clarity of purpose, backed by the research base.</li> <li><input type="checkbox"/> Clearly demonstrates that the implementation plan can be carried to completion as inquiry.</li> </ul>	
Identifies and Evaluates Actual Impacts of Decision	<ul style="list-style-type: none"> <li><input type="checkbox"/> Cannot clearly recognize more than one possible actual impact of the decision.</li> <li><input type="checkbox"/> Cannot effectively evaluate the effects of the decision taken.</li> </ul>	<ul style="list-style-type: none"> <li><input type="checkbox"/> Can clearly recognize more than one possible actual impact of the decision taken.</li> <li><input type="checkbox"/> Cannot effectively evaluate the effects of the decision taken in most instances.</li> </ul>	<ul style="list-style-type: none"> <li><input type="checkbox"/> Is able to recognize and comment upon the actual observed impacts of the decision.</li> <li><input type="checkbox"/> Demonstrates some ability to evaluate the impacts of the decision.</li> </ul>	<ul style="list-style-type: none"> <li><input type="checkbox"/> Is able to recognize and comment deeply upon the actual observed impacts of the decision, noting unforeseen or unique outcomes.</li> <li><input type="checkbox"/> Is able to evaluate the impacts of the decision with ease.</li> </ul>	
Reflects on the Decision Making of a Plan	<ul style="list-style-type: none"> <li><input type="checkbox"/> Begins to demonstrate an awareness of the need to review the implementation plan.</li> <li><input type="checkbox"/> Is reluctant to consider a re-evaluation of the plan.</li> </ul>	<ul style="list-style-type: none"> <li><input type="checkbox"/> Reflects upon and intends to communicate the results of the implementation plan.</li> <li><input type="checkbox"/> Has some difficulty in knowing how to proceed with a re-evaluation of the problem-solving plan.</li> </ul>	<ul style="list-style-type: none"> <li><input type="checkbox"/> Reflects upon and communicates the results of the implementation plan.</li> <li><input type="checkbox"/> Recognizes how to proceed with a re-evaluation of the problem-solving plan.</li> </ul>	<ul style="list-style-type: none"> <li><input type="checkbox"/> Reaches higher order of synthesis in the reflection process.</li> <li><input type="checkbox"/> Has a sophisticated environmental awareness that informs this post-implementation period.</li> </ul>	

*Note: The above criteria are suggestions only, and will need to be adapted in collaboration with students according to the purpose of the assignment.*



## Lab Report Assessment

Project Title \_\_\_\_\_ Date \_\_\_\_\_

Team Members \_\_\_\_\_

Area of Interest	Possible Points	Self	Teacher
<b>Formulates Testable Questions:</b> Question is testable and focused, and the cause-and-effect relationship is identified.			
<b>Formulates a Prediction/Hypothesis:</b> Independent and dependent variables are identified and the prediction/hypothesis clearly identifies a cause-and-effect relationship between these two variables.			
<b>Creates a Plan:</b> All steps are included and clearly described in a logical sequence. All required materials/equipment are identified. Safety considerations are addressed. Major intervening variables are controlled.			
<b>Conducts a Fair Test and Records Observations:</b> Evidence of repeated trials is presented and all data are included. Detailed data are recorded, and appropriate units are used. Data are recorded in a clear/well-structured/appropriate format for later reference.			
<b>Interprets and Evaluates Results:</b> Patterns/trends/discrepancies are identified. Strengths and weaknesses of approach and potential sources of error are identified. Changes to the original plan are identified and justified.			
<b>Draws a Conclusion:</b> Conclusion explains cause-and-effect relationship between dependent and independent variables. Alternative explanations are identified. Hypothesis is supported or rejected.			
<b>Makes Connections:</b> Potential applications are identified and/or links to area of study are made.			
<b>Total Points</b>			

## Rubric for Assessment of Student Presentation

Student Name(s) _____ Topic/Title _____		Performance Levels			
Criteria	Level 1	Level 2	Level 3	Level 4	
<b>Organization</b>	<input type="checkbox"/> Presentation shows poor organization and lack of preparation.  <input type="checkbox"/> Some student preparation is shown.	<input type="checkbox"/> Presentation shows signs of organization, but some parts do not seem to fit the topic.  <input type="checkbox"/> A fair amount of student preparation is shown.	<input type="checkbox"/> Presentation is organized, logical, and interesting.  <input type="checkbox"/> An adequate amount of student preparation is shown.	<input type="checkbox"/> Presentation is well organized, logical, interesting, and lively.  <input type="checkbox"/> A great deal of student preparation is shown.	
<b>Preparation</b>	<input type="checkbox"/> Small amount of material presented is related to the topic.	<input type="checkbox"/> Some material presented is not related to the topic.	<input type="checkbox"/> Almost all material presented is related to the topic.	<input type="checkbox"/> All material presented is related to the topic.	
<b>Language</b>	<input type="checkbox"/> Language used is hard to follow and understand.	<input type="checkbox"/> Some language used is hard to follow and understand.	<input type="checkbox"/> Most language used is easy to follow and understand.	<input type="checkbox"/> Language used is well chosen and is easy to follow and understand.	
<b>Format</b>	<input type="checkbox"/> Poor use of aids and support materials (diagrams, overheads, maps, pictures); few support the topic.	<input type="checkbox"/> Adequate use of aids and support materials; most support the topic.	<input type="checkbox"/> Good use of aids and support materials; almost all support the topic.	<input type="checkbox"/> Excellent use of aids and support materials; all aids support the topic.	
<b>Delivery</b>	<input type="checkbox"/> Many words are unclear or spoken too quickly or slowly; voice is monotonous; no pausing for emphasis; voice is too low to be heard easily.	<input type="checkbox"/> Some words are unclear or spoken too quickly at times; voice is somewhat varied; some pausing for emphasis; voice is sometimes too low to be heard easily.	<input type="checkbox"/> Most words are clear and generally spoken at the correct speed; voice is often varied and interesting; frequent pausing for emphasis; voice is loud enough to be heard easily.	<input type="checkbox"/> Words are clear and generally spoken at the correct speed; voice is frequently varied and interesting; effective pausing for emphasis; voice is loud enough to be heard easily.	
<b>Audience</b>	<input type="checkbox"/> Audience is not involved or interested.	<input type="checkbox"/> Audience is somewhat involved, and sometimes interested.	<input type="checkbox"/> Audience is involved and interested.	<input type="checkbox"/> Audience is very involved and interested.	

**Note:** The above criteria are suggestions only, and will need to be adapted in collaboration with students according to the purpose of the assignment.

## Rubric for Assessment of Class Presentation

Student Name(s) _____		Topic/Title _____			
Criteria	Performance Levels				
	Level 1	Level 2	Level 3	Level 4	
Content	<input type="checkbox"/> No understanding of the topic was evident.	<input type="checkbox"/> Basic understanding of the topic was evident. <input type="checkbox"/> No attempt was made to relate material presented to students' own experiences.	<input type="checkbox"/> Good understanding of the topic was evident. <input type="checkbox"/> Knowledge was thorough and detailed. <input type="checkbox"/> Attempt was made to relate material presented to students' own experiences.	<input type="checkbox"/> Excellent depth of understanding was evident. <input type="checkbox"/> Material presented went beyond what was required. Excellent research. <input type="checkbox"/> Material presented related to students' own experiences.	
Interest and Enthusiasm	<input type="checkbox"/> Presenter(s) displayed little interest in and enthusiasm for the topic of the presentation. <input type="checkbox"/> The class conveyed limited attentiveness during the presentation.	<input type="checkbox"/> Presenter(s) showed some interest in and enthusiasm for the topic. <input type="checkbox"/> The class showed some attentiveness during the presentation.	<input type="checkbox"/> Presenter(s) clearly showed interest in and enthusiasm for the topic. <input type="checkbox"/> The class was noticeably attentive during the presentation.	<input type="checkbox"/> Presenter(s) showed exceptional interest in and enthusiasm for the topic. <input type="checkbox"/> The class was keenly attentive during the presentation.	
Clarity and Organization of Material	<input type="checkbox"/> The information presented was confusing.	<input type="checkbox"/> The information presented was somewhat vague. <input type="checkbox"/> The presentation reflected some organization.	<input type="checkbox"/> The information was clearly presented. <input type="checkbox"/> The presentation was well organized.	<input type="checkbox"/> All information was relevant and clearly presented. <input type="checkbox"/> The presentation was exceptionally well organized. <input type="checkbox"/> Main points were emphasized and reinforced with appropriate examples.	
Use of Visual Aids	<input type="checkbox"/> Visual aids were not used.	<input type="checkbox"/> A few visual aids were used. <input type="checkbox"/> Visual aids were not well done. <input type="checkbox"/> Visual aids used were somewhat relevant to the presentation.	<input type="checkbox"/> Visual aids were used. <input type="checkbox"/> Visual aids were quite well done. <input type="checkbox"/> Visual aids were relevant to the presentation.	<input type="checkbox"/> Strong visual aids were used with care. <input type="checkbox"/> Visual aids were clear and exceptionally well done, showing effective use of colour. <input type="checkbox"/> Visual aids were designed to emphasize and strengthen the presentation and were successful.	

**Note:** This rubric would vary according to the assignment and the presentation format.



## Rubric for Assessment of Research Skills

Student Name(s)	Topic/Title			
	Performance Levels			
Research Skills	Level 1	Level 2	Level 3	Level 4
Ability to formulate questions to identify problems for research purposes	<input type="checkbox"/> Shows limited ability	<input type="checkbox"/> Shows some ability	<input type="checkbox"/> Shows general ability	<input type="checkbox"/> Shows consistent and thorough ability
Ability to locate relevant primary and secondary sources of information	<input type="checkbox"/> Unable to locate	<input type="checkbox"/> Somewhat able to locate	<input type="checkbox"/> Generally able to locate	<input type="checkbox"/> Always or almost always able to locate
Ability to locate and record relevant information from a variety of sources	<input type="checkbox"/> Unable to locate and record	<input type="checkbox"/> Somewhat able to locate and record	<input type="checkbox"/> Generally able to locate and record	<input type="checkbox"/> Always or almost always able to locate and record
Ability to organize information related to identified problem(s)	<input type="checkbox"/> Shows limited ability	<input type="checkbox"/> Shows some ability	<input type="checkbox"/> Shows general ability	<input type="checkbox"/> Shows consistent and thorough ability
Ability to analyze and synthesize information related to identified problems	<input type="checkbox"/> Shows limited ability	<input type="checkbox"/> Shows some ability	<input type="checkbox"/> Shows general ability	<input type="checkbox"/> Shows consistent and thorough ability
Ability to communicate results of inquiries using a variety of appropriate presentation forms (oral, media, written, graphic, pictorial, other)	<input type="checkbox"/> Unable to communicate	<input type="checkbox"/> Somewhat able to communicate	<input type="checkbox"/> Generally able to communicate	<input type="checkbox"/> Always or almost always able to communicate

**Note:** This rubric would vary according to the assignment and the presentation format.

## Rubric for Assessment of Scientific Inquiry

Student Name(s) \_\_\_\_\_ Topic/Title \_\_\_\_\_

Criteria	Performance Levels			
	Beginning 1	Developing 2	Accomplished 3	Exemplary 4
<b>Position Statement/ Proto-Abstract</b> (Not intended to be an abstract in the style and purpose of scientific journals)	The student <input type="checkbox"/> does not discuss the relevance of the inquiry	The student <input type="checkbox"/> offers some discussion but no clear explanation of the importance or goals of the inquiry	The student <input type="checkbox"/> discusses the importance of the inquiry but not its relationship to the curriculum or to the real world	The student <input type="checkbox"/> clearly summarizes the inquiry, highlights relevant information, and makes critical connections
<b>Objective/Purpose/ Testable Question</b> (Formulation of scientific questions and hypotheses)	<input type="checkbox"/> omits an objective/purpose, or states an objective not relevant to the problem under investigation	<input type="checkbox"/> states an objective that is not a hypothesis or a testable question, but identifies variables to be investigated	<input type="checkbox"/> states a testable question related to the problem, and identifies variables to be investigated	<input type="checkbox"/> clearly states a testable hypothesis that addresses the problem, and clearly delineates the variables to be tested
<b>Procedure</b> (Design of the investigation)	<input type="checkbox"/> does not outline reproducible steps in the procedure <input type="checkbox"/> shows some use of methodology, but no account of experimental or systematic error	<input type="checkbox"/> outlines clear, ordered steps in the procedure <input type="checkbox"/> identifies need for treatment of variables, but does not state how this will be achieved	<input type="checkbox"/> outlines clear, ordered steps in the procedure <input type="checkbox"/> identifies need for treatment of <i>specific</i> variables, and states how this will be achieved	<input type="checkbox"/> outlines clear, ordered steps in the procedure <input type="checkbox"/> identifies need for treatment of <i>specific</i> variables, and states how this will be achieved <input type="checkbox"/> provides a concise summary of the procedure
<b>Data Collection</b>	<input type="checkbox"/> collects some data that can be traced to the investigation itself, but data are inaccurate and incomplete	<input type="checkbox"/> provides reasonably complete data, organized in tabular form (+/- titles) <input type="checkbox"/> gives no indication of use of basic accuracy and precision techniques (e.g., significant figures)	<input type="checkbox"/> provides complete data, organized in tabular form (+/- titles) <input type="checkbox"/> demonstrates some use of basic accuracy and precision techniques (e.g., significant figures)	<input type="checkbox"/> provides complete data with error analysis, organized in tabular form (+/- titles) <input type="checkbox"/> demonstrates use of basic accuracy and precision techniques (e.g., significant figures)

(continued)

## Rubric for Assessment of Scientific Inquiry (continued)

		Performance Levels			
		Beginning 1	Developing 2	Accomplished 3	Exemplary 4
<b>Criteria</b>	Student Name(s) _____ Topic/Title _____				
<b>Analysis and Interpretation of Results</b>		<ul style="list-style-type: none"> <li><input type="checkbox"/> provides improper, incomplete graphical representation of data</li> <li><input type="checkbox"/> attempts no "fit" for plotted data</li> <li><input type="checkbox"/> requires abundance of supervision</li> </ul>	<ul style="list-style-type: none"> <li><input type="checkbox"/> provides proper graphical representation of data</li> <li><input type="checkbox"/> attempts to fit a <i>linear</i> regression line to data</li> <li><input type="checkbox"/> ensures axes are labelled correctly and positioned consistently with identified variables</li> </ul>	<ul style="list-style-type: none"> <li><input type="checkbox"/> provides proper graphical representation of data in a variety of forms</li> <li><input type="checkbox"/> shows evidence of mastery in fitting a <i>non-linear</i> regression line to data, and states <i>slope</i> and <i>y-intercept</i></li> <li><input type="checkbox"/> ensures axes are labelled correctly and positioned consistently with identified variables</li> <li><input type="checkbox"/> demonstrates understanding of how variables relate to a model equation</li> </ul>	
<b>Application/ Discussion of Scientific Results and Concepts</b>		<ul style="list-style-type: none"> <li><input type="checkbox"/> attempts to explain inquiry results in terms of random error alone ("where I went wrong")</li> <li><input type="checkbox"/> makes inaccurate, improper, or no conclusions based on data</li> </ul>	<ul style="list-style-type: none"> <li><input type="checkbox"/> attempts to connect inquiry results with model systems encountered in class experience</li> <li><input type="checkbox"/> identifies where systematic error may have caused problems</li> </ul>	<ul style="list-style-type: none"> <li><input type="checkbox"/> draws accurate and detailed comparison between the system under investigation and what could occur in an ideal system</li> <li><input type="checkbox"/> makes use of introductory statistical analyses</li> <li><input type="checkbox"/> identifies "outliers" in data set(s)</li> </ul>	
<b>Independence Factors</b> (Reliance on assistance)		<ul style="list-style-type: none"> <li><input type="checkbox"/> requires extensive assistance from text sources and classmates to do inquiry tasks</li> <li><input type="checkbox"/> requires constant teacher supervision</li> </ul>	<ul style="list-style-type: none"> <li><input type="checkbox"/> requires little assistance to complete inquiry tasks</li> <li><input type="checkbox"/> is able to internalize teacher intervention, and work independently afterward</li> </ul>	<ul style="list-style-type: none"> <li><input type="checkbox"/> requires no assistance to complete inquiry tasks</li> <li><input type="checkbox"/> demonstrates cooperation with partners</li> <li><input type="checkbox"/> resists efforts of others to assist</li> </ul>	<ul style="list-style-type: none"> <li><input type="checkbox"/> requires no assistance to complete inquiry tasks</li> <li><input type="checkbox"/> demonstrates cooperation with partners</li> <li><input type="checkbox"/> seeks opportunities to discuss procedures and results with others</li> </ul>

---

## Appendix 11: General and Specific Learning Outcomes

---

### General Learning Outcomes

General learning outcomes (GLOs) provide connections to the Five Foundations for Science Literacy that guide all Manitoba science curricula in all science discipline areas.

#### Nature of Science and Technology

As a result of their Senior Years science education, students will:

- A1** Recognize both the power and limitations of science as a way of answering questions about the world and explaining natural phenomena.
  - A2** Recognize that scientific knowledge is based on evidence, models, and explanations, and evolves as new evidence appears and new conceptualizations develop.
  - A3** Distinguish critically between science and technology in terms of their respective contexts, goals, methods, products, and values.
  - A4** Identify and appreciate contributions made by women and men from many societies and cultural backgrounds that have increased our understanding of the world and brought about technological innovations.
  - A5** Recognize that science and technology interact with and advance one another.
- 

#### Science, Technology, Society, and the Environment (STSE)

As a result of their Senior Years science education, students will:

- B1** Describe scientific and technological developments – past and present – and appreciate their impact on individuals, societies, and the environment, both locally and globally.
  - B2** Recognize that scientific and technological endeavours have been and continue to be influenced by human needs and the societal context of the time.
  - B3** Identify the factors that affect health, and explain the relationships among personal habits, lifestyle choices, and human health, both individual and social.
  - B4** Demonstrate knowledge of and personal consideration for a range of possible science- and technology-related interests, hobbies, and careers.
  - B5** Identify and demonstrate actions that promote a sustainable environment, society, and economy, both locally and globally.
-

### **Scientific and Technological Skills and Attitudes**

As a result of their Senior Years science education, students will:

- C1** Recognize safety symbols and practices related to scientific and technological activities and to their daily lives, and apply this knowledge in appropriate situations.
  - C2** Demonstrate appropriate scientific inquiry skills when seeking answers to questions.
  - C3** Demonstrate appropriate problem-solving skills when seeking solutions to technological challenges.
  - C4** Demonstrate appropriate critical thinking and decision-making skills when choosing a course of action based on scientific and technological information.
  - C5** Demonstrate curiosity, skepticism, creativity, open-mindedness, accuracy, precision, honesty, and persistence, and appreciate their importance as scientific and technological habits of mind.
  - C6** Employ effective communication skills and use information technology to gather and share scientific and technological ideas and data.
  - C7** Work cooperatively and value the ideas and contributions of others while carrying out scientific and technological activities.
  - C8** Evaluate, from a scientific perspective, information and ideas encountered during investigations and in daily life.
- 

### **Essential Science Knowledge**

As a result of their Senior Years science education, students will:

- D1** Understand essential life structures and processes pertaining to a wide variety of organisms, including humans.
  - D2** Understand various biotic and abiotic components of ecosystems, as well as their interaction and interdependence within ecosystems and within the biosphere as a whole.
  - D3** Understand the properties and structures of matter, as well as various common manifestations and applications of the actions and interactions of matter.
  - D4** Understand how stability, motion, forces, and energy transfers and transformations play a role in a wide range of natural and constructed contexts.
  - D5** Understand the composition of the Earth's atmosphere, hydrosphere, and lithosphere, as well as the processes involved within and among them.
  - D6** Understand the composition of the universe, the interactions within it, and the implications of humankind's continued attempts to understand and explore it.
-

## Unifying Concepts

As a result of their Senior Years science education, students will:

- E1** Describe and appreciate the similarity and diversity of forms, functions, and patterns within the natural and constructed world.
  - E2** Describe and appreciate how the natural and constructed world is made up of systems and how interactions take place within and among these systems.
  - E3** Recognize that characteristics of materials and systems can remain constant or change over time, and describe the conditions and processes involved.
  - E4** Recognize that energy, whether transmitted or transformed, is the driving force of both movement and change, and is inherent within materials and in the interactions among them.
- 

## Cluster 0: Skills and Attitudes

Cluster 0 in Grade 11 Chemistry comprises four categories of specific learning outcomes that describe the skills and attitudes involved in scientific inquiry and the decision-making process for Science, Technology, Society, and the Environment (STSE) issues. From Grades 5 to 10, students develop scientific inquiry through the development of a hypothesis/prediction, the identification and treatment of variables, and the formation of conclusions. Students begin to make decisions based on scientific facts and refine their decision-making skills as they progress through the grades, gradually becoming more independent. Students also develop key attitudes, an initial awareness of the nature of science, and other skills related to research, communication, the use of information technology, and cooperative learning.

In Grade 11 Chemistry, students continue to use scientific inquiry as an important process in their science learning, but also recognize that STSE issues require a more sophisticated treatment through the decision-making process.

Teachers should select appropriate contexts to introduce and reinforce scientific inquiry, the decision-making process, and positive attitudes within the thematic topics (Topics 1 to 5) throughout the school year. To assist in planning and to facilitate curricular integration, many specific learning outcomes within the Skills and Attitudes cluster can link to specific learning outcomes in other subject areas.

### Demonstrating Understanding

**C11-0-U1** Use appropriate strategies and skills to develop an understanding of chemical concepts.

*Examples: analogies, concept frames, concept maps, manipulatives, particulate representations, role-plays, simulations, sort-and-predict frames, word cycles...*

**C11-0-U2** Demonstrate an understanding of chemical concepts.

*Examples: use accurate scientific vocabulary, explain concepts to others, compare and contrast concepts, apply knowledge to new situations and/or contexts, create analogies, use manipulatives...*

---

### Scientific Inquiry

- C11-0-S1** Demonstrate work habits that ensure personal safety and the safety of others, as well as consideration for the environment.  
Include: knowledge and use of relevant safety precautions, Workplace Hazardous Materials Information System (WHMIS), emergency equipment
- C11-0-S2** State a testable hypothesis or prediction based on background data or on observed events.
- C11-0-S3** Design and implement an investigation to answer a specific scientific question.  
Include: materials, independent and dependent variables, controls, methods, safety considerations
- C11-0-S4** Select and use scientific equipment appropriately and safely.  
*Examples: volumetric glassware, balance, thermometer...*
- C11-0-S5** Collect, record, organize, and display data using an appropriate format.  
*Examples: labelled diagrams, graphs, multimedia applications, software integration, probeware...*
- C11-0-S6** Estimate and measure accurately using Système International (SI) and other standard units.  
Include: SI conversions, significant figures
- C11-0-S7** Interpret patterns and trends in data, and infer and explain relationships.
- C11-0-S8** Evaluate data and data-collection methods for accuracy and precision.  
Include: discrepancies in data, sources of error, percent error
- C11-0-S9** Draw a conclusion based on the analysis and interpretation of data.  
Include: cause-and-effect relationships, alternative explanations, supporting or rejecting a hypothesis or prediction
- 

### Research

- C11-0-R1** Synthesize information obtained from a variety of sources.  
Include: print and electronic sources, specialists, other resource people
- C11-0-R2** Evaluate information obtained to determine its usefulness for information needs.  
*Examples: scientific accuracy, reliability, currency, relevance, balance of perspectives, bias...*
- C11-0-R3** Quote from or refer to sources as required and reference information sources according to an accepted practice.
- C11-0-R4** Compare diverse perspectives and interpretations in the media and other information sources.
- C11-0-R5** Communicate information in a variety of forms appropriate to the audience, purpose, and context.
-

**Communication and Teamwork**

- C11-0-C1** Collaborate with others to achieve group goals and responsibilities.
- C11-0-C2** Elicit, clarify, and respond to questions, ideas, and diverse points of view in discussions.
- C11-0-C3** Evaluate individual and group processes.
- 

**Decision Making**

- C11-0-D1** Identify and explore a current STSE issue.  
*Examples: clarify what the issue is, identify different viewpoints and/or stakeholders, research existing data/information...*
- C11-0-D2** Evaluate implications of possible alternatives or positions related to an STSE issue.  
*Examples: positive and negative consequences of a decision, strengths and weaknesses of a position...*
- C11-0-D3** Recognize that decisions reflect values and consider their own values and those of others when making a decision.  
*Examples: being in balance with nature, generating wealth, respecting personal freedom...*
- C11-0-D4** Recommend an alternative or identify a position and provide justification.
- C11-0-D5** Propose a course of action related to an STSE issue.
- C11-0-D6** Reflect on the process used by self or others to arrive at an STSE decision.
- 

**Attitudes**

- C11-0-A1** Demonstrate confidence in their ability to carry out investigations in chemistry and to address STSE-related issues.
- C11-0-A2** Value skepticism, honesty, accuracy, precision, perseverance, and open-mindedness as scientific and technological habits of mind.
- C11-0-A3** Demonstrate a continuing, increasingly informed interest in chemistry and chemistry-related careers and issues.
- C11-0-A4** Be sensitive and responsible in maintaining a balance between the needs of humans and a sustainable environment.
-



## Specific Learning Outcomes

The specific learning outcomes (SLOs) identified here constitute the intended learning to be achieved by the student by the end of Grade 11 Chemistry. These statements clearly define what students are expected to achieve and/or be able to perform at the end of course. These SLOs, combined with the Skills and Attitudes SLOs, constitute the source upon which assessment and instructional design are based.

### Topic 1: Physical Properties of Matter

- C11-1-01** Describe the properties of gases, liquids, solids, and plasma.  
Include: density, compressibility, diffusion
- C11-1-02** Use the Kinetic Molecular Theory to explain properties of gases.  
Include: random motion, intermolecular forces, elastic collisions, average kinetic energy, temperature
- C11-1-03** Explain the properties of liquids and solids using the Kinetic Molecular Theory.
- C11-1-04** Explain the process of melting, solidification, sublimation, and deposition in terms of the Kinetic Molecular Theory.  
Include: freezing point, exothermic, endothermic
- C11-1-05** Use the Kinetic Molecular Theory to explain the processes of evaporation and condensation.  
Include: intermolecular forces, random motion, volatility, dynamic equilibrium
- C11-1-06** Operationally define vapour pressure in terms of observable and measurable properties.
- C11-1-07** Operationally define normal boiling point temperature in terms of vapour pressure.
- C11-1-08** Interpolate and extrapolate the vapour pressure and boiling temperature of various substances from pressure versus temperature graphs.
- 

### Topic 2: Gases and the Atmosphere

- C11-2-01** Identify the abundances of the naturally occurring gases in the atmosphere and examine how these abundances have changed over geologic time.  
Include: oxygenation of Earth's atmosphere, the role of biota in oxygenation, changes in carbon dioxide content over time
- C11-2-02** Research Canadian and global initiatives to improve air quality.
- C11-2-03** Examine the historical development of the measurement of pressure.  
*Examples: the contributions of Galileo Galilei, Evangelista Torricelli, Otto von Guericke, Blaise Pascal, Christiaan Huygens, John Dalton, Joseph Louis Gay-Lussac, Amadeo Avogadro...*

- C11-2-04** Describe the various units used to measure pressure.  
Include: atmospheres (atm), kilopascals (kPa), millimetres of mercury (mmHg), millibars (mb)
- C11-2-05** Experiment to develop the relationship between the pressure and volume of a gas using visual, numeric, and graphical representations.  
Include: historical contributions of Robert Boyle
- C11-2-06** Experiment to develop the relationship between the volume and temperature of a gas using visual, numeric, and graphical representations.  
Include: historical contributions of Jacques Charles, the determination of absolute zero, the Kelvin temperature scale
- C11-2-07** Experiment to develop the relationship between the pressure and temperature of a gas using visual, numeric, and graphical representations.  
Include: historical contributions of Joseph Louis Gay-Lussac
- C11-2-08** Solve quantitative problems involving the relationships among the pressure, temperature, and volume of a gas using dimensional analysis.  
Include: symbolic relationships
- C11-2-09** Identify various industrial, environmental, and recreational applications of gases.  
*Examples: self-contained underwater breathing apparatus (scuba), anaesthetics, air bags, acetylene welding, propane appliances, hyperbaric chambers...*
- 

### Topic 3: Chemical Reactions

- C11-3-01** Determine average atomic mass using isotopes and their relative abundance.  
Include: atomic mass unit (amu)
- C11-3-02** Research the importance and applications of isotopes.  
*Examples: nuclear medicine, stable isotopes in climatology, dating techniques...*
- C11-3-03** Write formulas and names for polyatomic compounds using International Union of Pure and Applied Chemistry (IUPAC) nomenclature.
- C11-3-04** Calculate the mass of compounds in atomic mass units.
- C11-3-05** Write and classify balanced chemical equations from written descriptions of reactions.  
Include: polyatomic ions
- C11-3-06** Predict the products of chemical reactions, given the reactants and type of reaction.  
Include: polyatomic ions
-

- C11-3-07** Describe the concept of the mole and its importance to measurement in chemistry.
- C11-3-08** Calculate the molar mass of various substances.
- C11-3-09** Calculate the volume of a given mass of a gaseous substance from its density at a given temperature and pressure.  
Include: molar volume calculation
- C11-3-10** Solve problems requiring interconversions between moles, mass, volume, and number of particles.
- C11-3-11** Determine empirical and molecular formulas from percent composition or mass data.
- C11-3-12** Interpret a balanced equation in terms of moles, mass, and volumes of gases.
- C11-3-13** Solve stoichiometric problems involving moles, mass, and volume, given the reactants and products in a balanced chemical reaction.  
Include: heat of reaction problems
- C11-3-14** Identify the limiting reactant and calculate the mass of a product, given the reaction equation and reactant data.
- C11-3-15** Perform a lab involving mass-mass or mass-volume relations, identifying the limiting reactant and calculating the mole ratio.  
Include: theoretical yield, experimental yield
- C11-3-16** Discuss the importance of stoichiometry in industry and describe specific applications.  
*Examples: analytical chemistry, chemical engineering, industrial chemistry...*
- 

#### **Topic 4: Solutions**

- C11-4-01** Describe and give examples of various types of solutions.  
Include: all nine possible types
- C11-4-02** Describe the structure of water in terms of electronegativity and the polarity of its chemical bonds.
- C11-4-03** Explain the solution process of simple ionic and covalent compounds, using visual, particulate representations and chemical equations.  
Include: crystal structure, dissociation, hydration
- C11-4-04** Explain heat of solution with reference to specific applications.  
*Examples: cold packs, hot packs...*
- C11-4-05** Perform a lab to illustrate the formation of solutions in terms of the polar and non-polar nature of substances.  
Include: soluble, insoluble, miscible, immiscible

- C11-4-06** Construct, from experimental data, a solubility curve of a pure substance in water.
- C11-4-07** Differentiate among saturated, unsaturated, and supersaturated solutions.
- C11-4-08** Use a graph of solubility data to solve problems.
- C11-4-09** Explain how a change in temperature affects the solubility of gases.
- C11-4-10** Explain how a change in pressure affects the solubility of gases.
- C11-4-11** Perform a lab to demonstrate freezing-point depression and boiling-point elevation.
- C11-4-12** Explain freezing-point depression and boiling-point elevation at the molecular level.  
*Examples: antifreeze, road salt...*
- C11-4-13** Differentiate among, and give examples of, the use of various representations of concentration.  
Include: grams per litre (g/L), % weight-weight (% w/w), % weight-volume (% w/v), % volume/volume (% v/v), parts per million (ppm), parts per billion (ppb), moles per litre (mol/L) (molarity)
- C11-4-14** Solve problems involving calculation for concentration, moles, mass, and volume.
- C11-4-15** Prepare a solution, given the amount of solute (in grams) and the volume of solution (in millilitres), and determine the concentration in moles/litre.
- C11-4-16** Solve problems involving the dilution of solutions.  
Include: dilution of stock solutions, mixing common solutions with different volumes and concentrations
- C11-4-17** Perform a dilution from a solution of known concentration.
- C11-4-18** Describe examples of situations where solutions of known concentration are important.  
*Examples: pharmaceutical preparations, administration of drugs, aquaria, swimming-pool disinfectants, gas mixes for scuba, radiator antifreeze...*
- C11-4-19** Describe the process of treating a water supply, identifying the allowable concentrations of metallic and organic species in water suitable for consumption.
-

### Topic 5: Organic Chemistry

- C11-5-01** Compare and contrast inorganic and organic chemistry.  
 Include: the contributions of Friedrich Wöhler to the overturn of vitalism
- C11-5-02** Identify the origins and major sources of hydrocarbons and other organic compounds.  
 Include: natural and synthetic sources
- C11-5-03** Describe the structural characteristics of carbon.  
 Include: bonding characteristics of the carbon atom in hydrocarbons (single, double, triple bonds)
- C11-5-04** Compare and contrast the molecular structures of alkanes, alkenes, and alkynes.  
 Include: trends in melting points and boiling points of alkanes only
- C11-5-05** Name, draw, and construct structural models of the first 10 alkanes.  
 Include: IUPAC nomenclature, structural formulas, condensed structural formulas, molecular formulas, general formula  $C_nH_{(2n+2)}$
- C11-5-06** Name, draw, and construct structural models of branched alkanes.  
 Include: six-carbon parent chain, methyl and ethyl substituent groups, IUPAC nomenclature
- C11-5-07** Name, draw, and construct structural models of isomers for alkanes up to six-carbon atoms.  
 Include: condensed structural formulas
- C11-5-08** Outline the transformation of alkanes to alkenes and vice versa.  
 Include: dehydrogenation/hydrogenation, molecular models
- C11-5-09** Name, draw, and construct molecular models of alkenes and branched alkenes.  
 Include: six-carbon parent chain, methyl and ethyl substituent groups, IUPAC nomenclature, structural formulas, condensed structural formulas, molecular formulas, general formula  $C_nH_{2n}$
- C11-5-10** Differentiate between saturated and unsaturated hydrocarbons.
- C11-5-11** Outline the transformation of alkenes to alkynes and vice versa.  
 Include: dehydrogenation/hydrogenation, molecular models
- C11-5-12** Name, draw, and construct structural models of alkynes and branched alkynes.  
 Include: six-carbon parent chain, methyl and ethyl substituent groups, IUPAC nomenclature, structural formulas, condensed structural formulas, molecular formulas, general formula  $C_nH_{2n-2}$
- C11-5-13** Compare and contrast the structure of aromatic and aliphatic hydrocarbons.  
 Include: molecular models, condensed structural formulas

- C11-5-14** Describe uses of aromatic hydrocarbons.  
*Examples: polychlorinated biphenyls, caffeine, steroids, organic solvents (toluene, xylene)...*
- C11-5-15** Write condensed structural formulas for and name common alcohols.  
Include: maximum of six-carbon parent chain, IUPAC nomenclature
- C11-5-16** Describe uses of methyl, ethyl, and isopropyl alcohols.
- C11-5-17** Write condensed structural formulas for and name organic acids.  
Include: maximum of six-carbon parent chain, IUPAC nomenclature
- C11-5-18** Describe uses or functions of common organic acids.  
*Examples: acetic, ascorbic, citric, formic, acetylsalicylic (ASA), lactic...*
- C11-5-19** Perform a lab involving the formation of esters, and examine the process of esterification.
- C11-5-20** Write condensed structural formulas for and name esters.  
Include: up to 6-C alcohols and 6-C organic acids, IUPAC nomenclature
- C11-5-21** Describe uses of common esters.  
*Examples: pheromones, artificial flavourings...*
- C11-5-22** Describe the process of polymerization and identify important natural and synthetic polymers.  
*Examples: polyethylene, polypropylene, polystyrene, polytetrafluoroethylene (Teflon®)...*
- C11-5-23** Describe how the products of organic chemistry have influenced quality of life.  
*Examples: synthetic rubber, nylon, medicines, polytetrafluoroethylene (Teflon®)...*
- C11-5-24** Use the decision-making process to investigate an issue related to organic chemistry.  
*Examples: gasohol production, alternative energy sources, recycling of plastics...*
-



## BIBLIOGRAPHY

---





## BIBLIOGRAPHY

- Alberta Education. *Workshop Materials*. Edmonton, AB: Alberta Education, 1989.
- Andrews, William A., T.J. Elgin Wolfe, and John F. Eix. *Physical Science: An Introductory Study*. Scarborough, ON: Prentice-Hall of Canada, Ltd., 1978.
- Barton, L. "The Definition of a Mole." *CHEM 13 NEWS* (Feb. 2005): 10-11.
- Barton, Leslie. "Plastic: Chemistry, Commerce and Culture in Canada, 1945–Present." *CHEM 13 NEWS* 324 (Nov. 2004): 15.
- Becker, Bob. *Twenty Demonstrations Guaranteed to Knock Your Socks Off*. Batavia, IL: Flinn Scientific, Inc., 1994.
- Bransford, John D., Ann L. Brown, and Rodney R. Cocking, eds. *How People Learn: Brain, Mind, Experience, and School*. Expanded Edition. A National Research Council Report. Washington, DC: National Academy Press, 2000.
- Brown, Theodore E., H. Eugene LeMay, and Bruce E. Bursten. *Chemistry: The Central Science*. 9th ed. Upper Saddle River, NJ: Pearson Education/Prentice Hall, 2003.
- Brubacher, Lew. "Diamonds." *CHEM 13 NEWS* 327 (Feb. 2005): 1, 4-6.
- Bybee, Rodger W., C. Edward Buchwald, Sally Crissman, David R. Heil, Paul J. Kuerbis, Carolee Matsumoto, and Joseph P. McInerney. *Science and Technology Education for the Elementary Years: Frameworks for Curriculum and Instruction*. Rowley, MA: The National Center for Improving Science Education (The NETWORK Inc.), 1989.
- Champagne, A.B., R.F. Gunstone, and L.E. Klopfer. "Instructional Consequences of Students' Knowledge about Physical Phenomena." *Cognitive Structure and Conceptual Change*. Ed. L.H.T. West and A.L. Pines. New York, NY: Academic Press, 1985. 61-90.
- Chang, Raymond. *Chemistry*. 4th ed. Boston, MA: McGraw-Hill Higher Education, 1991.
- Chemical Education Material Study. *Chemistry: An Experimental Science Laboratory Manual*. San Francisco, CA: W.H. Freeman and Company, 1963.
- Clement, John. "A Conceptual Model Discussed by Galileo and Used Intuitively by Physics Students." *Mental Models*. Ed. Dedre Gentner and Albert L. Stevens. London, UK: Lawrence Erlbaum Associates, 1983.
- Clinton, Laura, and Catheryn Lee. "Diamonds in the Snow." *CHEM 13 NEWS* 327 (Feb. 2005): 6-7.
- Coggan, Jenn. "Organic Molecules of Everyday Life: 1. Citronellal." *CHEM 13 NEWS* 324 (Nov. 2004): 1-2.

- Corno, Lyn, and Judi Randi. "Motivation, Volition, and Collaborative Innovation in Classroom Literacy." *Reading Engagement: Motivating Readers through Integrated Sources*. Ed. John T. Guthrie and Allan Wigfield. Newark, DE: International Reading Association, 1997. 51-67.
- Council of Ministers of Education, Canada. *Common Framework of Science Learning Outcomes K to 12: Pan-Canadian Protocol for Collaboration on School Curriculum*. Toronto, ON: Council of Ministers of Education, Canada, 1997.
- CRC Handbook of Chemistry and Physics: A Ready-Reference Book of Chemical and Physical Data*. Cleveland, OH: CRC Press, annual publication.
- Davies, Lucille, Maurice Di Giuseppe, Ted Gibb, Milan Sanader, and Angela Vavitsas. *Nelson Chemistry 12: College Preparation*. Ontario Edition. Toronto, ON: Thomson Nelson, 2003.
- Dietz, Phyllis M., Robert L. Tellefsen, Robert W. Parry, and Luke E. Steiner. *Chemistry: Experimental Foundations – Laboratory Manual*. 2nd ed. Englewood Cliffs, NJ: Prentice-Hall, Inc., 1975.
- Dingrando, Laurel, Kathleen (Gregg) Tallman, Nichols Hainen, and Cheryl Wistrom. *Glencoe Chemistry: Matter and Change*. Columbus, OH: Glencoe/McGraw-Hill, 2005.
- Drake, Susan M. *Planning Integrated Curriculum: The Call to Adventure*. Alexandria, VA: Association for Supervision and Curriculum Development, 1993.
- Duxbury, Alison B., and Alyn C. Duxbury. *Fundamentals of Oceanography*. Dubuque, IA: Wm. C. Brown Publishers, 1996.
- Ellis, Edwin S., Donald D. Deshler, B. Keith Lenz, Jean B. Shumaker, and Francis L. Clark. "An Instructional Model for Teaching Learning Strategies." *Focus on Exceptional Children* 23.6 (Feb. 1991): 1-22.
- English, James, and Harold G. Cassidy. *Principles of Organic Chemistry: An Introductory Text in Organic Chemistry*. New York, NY: McGraw-Hill Book Company, Inc. 1961.
- Environment Canada. "Isotopes Link Birds to Breeding and Moulting Areas." *Science and the Environment Bulletin* (May/June 2001). 22 June 2006 <[http://www.ec.gc.ca/science/sandemay01/article7\\_e.html](http://www.ec.gc.ca/science/sandemay01/article7_e.html)>.
- Foster, Graham. *Student Self-Assessment: A Powerful Process for Helping Students Revise Their Writing*. Markham, ON: Pembroke, 1996.
- Glatthorn, Allan A. *Learning Twice: An Introduction to the Methods of Teaching*. New York, NY: HarperCollins College, 1993.
- Glencoe Chemistry: Matter and Change: CBL Laboratory Manual – Teacher Edition*. Columbus, OH: Glencoe/McGraw-Hill, n.d.
- Glencoe Chemistry: Matter and Change: Laboratory Manual – Teacher Edition*. Columbus, OH: Glencoe/McGraw-Hill, 2005.

- Glencoe Chemistry: Matter and Change: Small-Scale Laboratory Manual – Teacher Edition.* Columbus OH: Glencoe/McGraw-Hill, 2005.
- Good, Thomas L., and Jero E. Brophy. *Looking in Classrooms.* New York, NY: Harper and Row, 1987.
- Hake, R.R. "Interactive Engagement Versus Traditional Methods: A Six-Thousand-Student Survey of Mechanics Test Data for Introductory Physics Courses." *American Journal of Physics* 66.1 (1998): 64-74.
- Hammer, D. "Discovery Learning and Discovery Teaching." *Cognition and Instruction* 15.4 (1997): 485-529.
- . "Epistemological Considerations in Teaching Introductory Physics." *Science Education* 79.4 (1995): 393-413.
- Hestenes, David, and Malcolm Wells. "A Mechanics Baseline Test." *The Physics Teacher* 30.3 (1992): 159-166.
- Hestenes, David, Malcolm Wells, and Gregg Swackhamer. "Force Concept Inventory." *The Physics Teacher* 30 (1992): 141-151.
- Hewson, P.W. "Epistemological Commitments in the Learning of Science: Examples from Dynamics." *European Journal of Science Education* 7.2 (1985): 163-172.
- Hitt, Austin, Orvil White, and Debbie Hanson. "Popping the Kernel: Modeling the States of Matter." *Science Scope* (Jan. 2005): 39-41.
- Hodson, Derek. "Philosophy of Science and Science Education." *Journal of Philosophy of Education* 20 (1986): 215-225.
- . "Toward Universal Scientific Literacy." *Science, Math and Technology Learning for All.* Spec. issue of *Orbit* 31.3 (2000): 13-15. Available online at <[http://www.oise.utoronto.ca/orbit/core1\\_math.html](http://www.oise.utoronto.ca/orbit/core1_math.html)>.
- Holmquist, Dan, and Donald Volz. *Chemistry with Calculators.* Portland, OR: Vernier, n.d. Available online at <<http://www.vernier.com/chemistry/>>.
- . *Chemistry with Computers.* Portland, OR: Vernier, n.d. Available online at <<http://www.vernier.com/chemistry/>>.
- Hoy, R.R. "A 'Model Minority' Speaks Out on Cultural Shyness." *Science* 262 (1993): 1117-1118.
- Jenkins, Frank, Hans van Kessel, Lucille Davies, Oliver Lantz, Patricia Thomas, and Dick Tompkins. *Nelson Chemistry 11.* Ontario Edition. Toronto, ON: Nelson Thomson Learning, 2002.
- Kolodny, A. "Colleges Must Recognize Students' Cognitive Styles and Cultural Backgrounds." *Chronicle of Higher Education* 37.21 (1991): A44.
- Kuhn, Thomas. "Objectivity, Value Judgement, and Theory Choice." *The Essential Tension: Selected Studies in Scientific Tradition and Change.* Chicago, IL: University of Chicago Press, 1977. 320-339.

- Kuhn, Thomas S. *The Structure of Scientific Revolutions*. Chicago, IL: University of Chicago Press, 1962.
- Larochelle, Marie, and Jacques Désautels. *About Science: Students' Cognitive Paths*. Laval, QC: Presse de l'université Laval, 1992.
- Larochelle, Marie, et Jacques Désautels. *Autour de l'idée de science : itinéraires cognitifs d'étudiants et d'étudiantes*. Laval, QC: Presse de l'université Laval, 1992.
- Lederman, Norm G., Fouad Abd-El-Khalick, Randy L. Bell, and Renée S. Schwartz. "Views of Nature of Science Questionnaire: Toward Valid and Meaningful Assessment of Learners' Conceptions of the Nature of Science." *Journal of Research in Science Teaching* 39.6 (2002): 497-521.
- LeMay, Eugene H., Herbert Beall, Karen M. Robblee, and Douglas C. Brouwer. *Prentice Hall Chemistry: Connections to Our Changing World*. Upper Saddle River, NJ: Pearson Education/Prentice Hall, 2002.
- Levinson, Gerald S. "A Simple Experiment for Determining Vapour Pressure and Enthalpy of Vaporization of Water." *Journal of Chemical Education* 59.4 (Apr. 1982): 337-338.
- Lide, David R., ed. *CRC Handbook of Chemistry and Physics: A Ready-Reference Book of Chemical and Physical Data*. Cleveland, OH: CRC Press, annual publication.
- Linstromberg, Walter W., and Henry E. Baumgarten. *Organic Chemistry: A Brief Course*. Lexington, MA: D.C. Heath and Company, 1978.
- Locke, E.A., and G.P. Latham. *A Theory of Goal Setting and Task Performance*. Englewood Cliffs, NJ: Prentice Hall, 1990.
- Manitoba Education and Training. *Education for a Sustainable Future: A Resource for Curriculum Developers, Teachers, and Administrators*. Winnipeg, MB: Manitoba Education and Training, 2000. Available online at <<http://www.edu.gov.mb.ca/k12/docs/support/future/>>.
- . *A Foundation for Excellence*. Winnipeg, MB: Manitoba Education and Training, 1995.
- . *Grades 5 to 8 Science: A Foundation for Implementation*. Winnipeg, MB: Manitoba Education and Training, 2000.
- . *Reporting on Student Progress and Achievement: A Policy Handbook for Teachers, Administrators, and Parents*. Winnipeg, MB: Manitoba Education and Training, 1997.
- . *Science Safety: A Kindergarten to Senior 4 Resource Manual for Teachers, Schools, and School Divisions*. Winnipeg, MB: Manitoba Education and Training, 1997.
- . *Senior 1 Science: A Foundation for Implementation*. Winnipeg, MB: Manitoba Education and Training, 2000.
- . *Senior 2 English Language Arts: A Foundation for Implementation*. Winnipeg, MB: Manitoba Education and Training, 1998.

- . *Senior 3 English Language Arts: A Foundation for Implementation*. Winnipeg, MB: Manitoba Education and Training, 1999.
- . *Senior 4 English Language Arts: A Foundation for Implementation*. Winnipeg, MB: Manitoba Education and Training, 2000.
- . *Senior Years Science Teachers' Handbook: A Teaching Resource*. Winnipeg, MB: Manitoba Education and Training, 1997.
- . *Success for All Learners: A Handbook on Differentiating Instruction: A Resource for Kindergarten to Senior 4*. Winnipeg, MB: Manitoba Education and Training, 1996.
- . *Technology As a Foundation Skill Area: A Journey Toward Information Technology Literacy: A Resource for Curriculum Developers, Teachers, and Administrators*. Winnipeg, MB: Manitoba Education and Training, 1998.
- Manitoba Education and Youth. *Senior 2 Science: A Foundation for Implementation*. Winnipeg, MB: Manitoba Education and Youth, 2003.
- Manitoba Education, Citizenship and Youth. *Rethinking Classroom Assessment with Purpose in Mind: Assessment for Learning, Assessment as Learning, Assessment of Learning*. Winnipeg, MB: Manitoba Education, Citizenship and Youth, 2006.
- . *Senior 3 Current Topics in the Sciences: A Foundation for Implementation*. Winnipeg, MB: Manitoba Education, Citizenship and Youth, 2005.
- Manitoba Sustainable Development Coordination Unit. *Sustainable Development Strategy for Manitoba*. Winnipeg, MB: Sustainable Development Coordination Unit, 1998.
- Mauch, John. "Can You Vacuum Pack a Person?" 22 June 2006  
<[http://manzano.aps.edu/science/notes/acs\\_meeting/VacuumPack.doc](http://manzano.aps.edu/science/notes/acs_meeting/VacuumPack.doc)>.
- Maxwell, Rhoda J., and Mary J. Meiser. *Teaching English in Middle and Secondary Schools*. 2nd ed. Upper Saddle River, NJ: Prentice Hall, 1997.
- McComas, W.F. "Ten Myths of Science: Re-examining What We Think We Know about the Nature of Science." *School Science and Mathematics* 96 (1996): 10-16.
- McDermott, L.C. "What We Teach and What Is Learned – Closing the Gap." *American Journal of Physics* 59.4 (1991): 301-315.
- McDermott, L.C., and E.F. Redish. "Resource Letter PER-1: Physics Education Research." *American Journal of Physics* 67 (1999): 755-767.
- Millar, Robin, and Jonathan Osborne, eds. *Beyond 2000: Science Education for the Future*. London, UK: King's College, 1998. Available online at  
<<http://www.kcl.ac.uk/depsta/education/be2000/be2000.pdf>>.
- Mustoe, Frank, Michael P. Jansen, Ted Doram, John Ivanco, Christina Clancy, and Anita Ghazariansteja. *McGraw-Hill Ryerson Chemistry*. Combined Atlantic Edition. Toronto, ON: McGraw-Hill Ryerson, 2004.

- . *McGraw-Hill Ryerson Chemistry 11*. Ontario Edition. Toronto, ON: McGraw-Hill Ryerson, 2001.
- National Academy of Sciences (NAS). *Changing Emphases in Assessment of Student Learning*. Washington, DC: National Academy Press, 1996.
- National Research Council (NRC). *National Science Education Standards*. Washington, DC: National Academy Press, 1996.
- . Committee on Undergraduate Science Education. *Science Teaching Reconsidered*. Washington, DC: National Academy Press, 1997.
- Oakley, Burks II. *Nitrox Scuba Diving*. University of Illinois at Springfield. 30 April 2000 <<http://www.online.uillinois.edu/oakley/nitrox.html>>.
- Parry, Robert W., Phyllis M. Dietz, Robert L. Tellefsen, and Luke E. Steiner. *Chemistry: Experimental Foundations*. 2nd ed. Englewood Cliffs, NJ: Prentice-Hall, Inc., 1975.
- PASCO Scientific. *PASPort Explorations in Chemistry Lab Manual*. Roseville, CA: PASCO, n.d. Available online at <<http://www.pasco.com/hsmanuals/ps2808.html>>.
- Pavia, Donald L., Gary M. Lampman, and George S. Kriz. "Esters – Flavors and Fragrances." *Introduction to Organic Laboratory Techniques: A Contemporary Approach*. Philadelphia, PA: W.B. Saunders Company, 1976. 91-94.
- Phillips, John S., Victor S. Strozak, and Cheryl Wistrom. *Chemistry: Concepts and Applications*. Columbus, OH: Glencoe/McGraw-Hill, 2005.
- Probst, Robert E. *Response and Analysis: Teaching Literature in Junior and Senior High School*. Don Mills, ON: Heinemann, 1988.
- Purcell-Gates, Victoria. "Process Teaching with Direct Instruction and Feedback in a University-Based Clinic." *Balanced Instruction: Strategies and Skills in Whole Language*. Ed. Ellen McIntyre and Michael Pressley. Norwood, MA: Christopher-Gordon, 1996. 107-127.
- Reif, F., and J.H. Larkin. "Cognition in Scientific and Everyday Domains: Comparison and Learning Implications." *Journal of Research in Science Teaching* 28 (1991): 733-760.
- Ryan, Richard M., James P. Connell, and Edward L. Deci. "A Motivational Analysis of Self-Determination and Self-Regulation in Education." *Research and Motivation in Education: The Classroom Milieu*. Ed. Russell Ames and Carole Ames. Vol. 2. New York, NY: Academia Press, 1985. 13-51.
- Santa, C.M. *Context Reading Including Study Systems*. Dubuque, IA: Kendall Hunt, 1988.
- Saskatchewan Education. *Instructional Approaches: A Framework for Professional Practice*. Regina, SK: Saskatchewan Education, 1991.

- Schunk, Dale H., and Barry Zimmerman. "Developing Self-Efficacious Readers and Writers: The Role of the Social and Self-Regulatory Processes." *Reading Engagement: Motivating Readers through Integrated Sources*. Ed. John T. Guthrie and Allan Wigfield. Newark, DE: International Reading Association, 1997.
- Seidel, A., ed. *Solubilities of Inorganic and Organic Compounds*. Vol. 1. New York, NY: D. van Nostrand Co., Inc., 1911.
- Silberberg, Martin S. *Chemistry: The Molecular Nature of Matter and Change*. Boston, MA: McGraw-Hill Higher Education, 2003.
- Silver, E.A., and S.P. Marshall. "Mathematical and Scientific Problem Solving: Findings, Issues, and Educational Implications." *Dimensions of Thinking and Cognitive Instruction*. Ed. B.J. Jones and L. Idol. Hillsdale, NJ: Lawrence, 1990. 265-290.
- Slater, A., and G. Rayner-Canham. *Microscale Chemistry Laboratory Manual*. Reading, MA: Addison-Wesley, 1994.
- Strickland, Dorothy S., and Michael R. Strickland "Language and Literacy: The Poetry Connection." *Language Arts* 74 (Mar. 1997): 201-205.
- Sustainability Manitoba. *Sustainable Development Strategy for Manitoba*. Winnipeg, MB: Sustainability Manitoba, 1998.
- Turner, Julianne C. "Starting Right: Strategies for Engaging Young Literacy Learners." *Reading Engagement: Motivating Readers through Integrated Sources*. Ed. John T. Guthrie and Allan Wigfield. Newark, DE: International Reading Association, 1997. 183-204.
- United Nations Educational, Scientific and Cultural Organization (UNESCO). "Le développement durable grace a l'éducation relative a l'environnement." *Connexion* 13.2 (June 1988): 3.
- van Kessel, Hans, Frank Jenkins, Lucille Davies, Donald Plumb, Maurice Di Giuseppe, Oliver Lanz, and Dick Tompkins. *Nelson Chemistry 12*. Ontario Edition. Toronto, ON: Thomson Nelson, 2003.
- Weast, Robert C., ed. *CRC Handbook of Chemistry and Physics: A Ready-Reference Book of Chemical and Physical Data*. 56th ed. Cleveland, OH: CRC Press, 1975.
- White, B.Y., and J.R. Frederiksen. "Inquiry, Modeling, and Metacognition: Making Science Accessible to All Students." *Cognition and Instruction* 16.1 (1998): 3-118.
- Wiggins, Grant. "What Is a Rubric? A Dialogue on Design and Use." *Handbook for Student Performance Assessment in the Era of Restructuring*. Ed. Robert E. Blum and Judith A. Arter. Alexandria, VA: Association for Supervision and Curriculum Development (ASCD), 1995. 1-13.
- Wilbraham, Antony C., Dennis D. Staley, Michael S. Matta, and Edward L. Waterman. *Prentice Hall Chemistry*. Upper Saddle River, NJ: Pearson Education/Prentice Hall, 2005.



- Williams, Park. "Don't Be an Isotope, Learn about an Isotope." 22 June 2006  
<<http://www.geog.ucsb.edu/~williams/Isotopes.htm>>.
- Williams, Robin. *The Non-Designer's Design Book: Design and Typographic Principles for the Visual Novice*. Berkeley, CA: Peachpit Press, 1994.
- Willis, Scott. "Interdisciplinary Learning: Movement to Link the Disciplines Gains Momentum." *ASCD Curriculum Update* (Nov. 1992): 1-8.
- Wood, D., J. Bruner, and G. Ross. "The Role of Tutoring in Problem Solving." *Journal of Child Psychology and Psychiatry* 17 (1976): 89-100.
- Zumdahl, Steven S. *Introductory Chemistry: A Foundation*. 4th ed. Boston, MA: Houghton-Mifflin, 2004.
- Zumdahl, Steven S., and Susan A. Zumdahl. *Chemistry*. 6th ed. Boston, MA: Houghton-Mifflin, 2003.

### Websites

- Agriculture and Agri-Food Canada. Cereal Research Centre, Winnipeg:  
<[http://res2.agr.ca/winnipeg/v1\\_e.htm](http://res2.agr.ca/winnipeg/v1_e.htm)>
- Alberta. Oil Sands Discovery Centre. The Oil Sands Story: Upgrading:  
<[http://www.oilsandsdiscovery.com/oil\\_sands\\_story/upgrade.html](http://www.oilsandsdiscovery.com/oil_sands_story/upgrade.html)>
- Alternate Energy Resource Network: <<http://www.alternate-energy.net/>>
- Alternative Energy, Renewable Energy – Hydrogen , Solar, Biofuel, Geothermal, Hydro, and More: <[http://curtrosengren.typepad.com/alternative\\_energy/](http://curtrosengren.typepad.com/alternative_energy/)>
- The American Plastics Council. Plastic Recycling Resources:  
<[http://www.plasticsresource.com/s\\_plasticsresource/doc.asp?TRACKID=&CID=40&DID=420](http://www.plasticsresource.com/s_plasticsresource/doc.asp?TRACKID=&CID=40&DID=420)>
- Andy Darvill's Science Site. Energy Resources:  
<<http://www.darvill.clara.net/altenerg/>>
- Association of Canadian Underwater Councils (ACUC): <<http://www.acuc.ca>>
- AUS-e-TUTE. Haber Process for the Production of Ammonia:  
<<http://www.ausetute.com.au/haberpro.html>>.
- AZCO Industries Limited: <<http://www.azco.bc.ca/info/chlorine.htm>>.
- Canadian Plastics Industry Association. Environment and Plastics Industry Council (EPIC): <<http://www.cpia.ca/epic/media/news.php?ID=1332>>
- . ---. Teacher Resource Site: <<http://www.plastics.ca/teachers/>>
- The Catalyst: Chemistry Resource for the Secondary Education Teacher on the WWW: <<http://catalyst.8media.org/m13organ.html>>

- The Chemical Heritage Foundation. Antibiotics in Action: Teacher's Guide:  
<<http://www.chemheritage.org/educationalservices/pharm/tg/antibiot/activity/size.htm>>
- . Molecular Size: Oleic Acid Monolayers:  
<<http://www.chemheritage.org/educationalservices/pharm/antibiot/activity/size.htm>>
- Chemistry Coach: <<http://www.chemistrycoach.com/tutorial.htm#tutorials>>
- Connecticut Department of Environmental Protection. PCBs:  
<<http://dep.state.ct.us/wst/pcb/pcbindex.htm>>
- Curt Rosengren. Alternative Energy – Renewable Energy:  
<[http://curtrosengren.typepad.com/alternative\\_energy/](http://curtrosengren.typepad.com/alternative_energy/)>
- Doc Brown's Chemistry Clinic:  
<<http://www.wpbschoolhouse.btinternet.co.uk/page06/FunctionalGroups.htm>>
- eMedicine (from WebMD). Toxicity, Toluene:  
<<http://www.emedicine.com/emerg/topic594.htm>>
- Energy Alternatives Ltd.: <<http://www.energyalternatives.ca/conservation.asp>>
- Environment Canada: <<http://www.ec.gc.ca>>.
- . Clean Air Online: <<http://www.ec.gc.ca/cleanair-airpur/>>
- . ---. Science and Research: <[http://www.ec.gc.ca/cleanair-airpur/Science\\_and\\_Research-WS955E8065-1\\_En.htm](http://www.ec.gc.ca/cleanair-airpur/Science_and_Research-WS955E8065-1_En.htm)>
- . The CEPA Environmental Registry: <<http://www.ec.gc.ca/CEPARRegistry/>>
- . "Isotopes Link Birds to Breeding and Moulting Areas." Science and the Environment Bulletin (May/June 2001):  
<[http://www.ec.gc.ca/science/sandemay01/article7\\_e.html](http://www.ec.gc.ca/science/sandemay01/article7_e.html)>
- The Environment Directory:  
<[http://www.webdirectory.com/Science/Energy/Alternative\\_Energy/](http://www.webdirectory.com/Science/Energy/Alternative_Energy/)>
- The Fishtank Crew: <<http://pcpages.com/fish/nitrogen1.html>>
- The Friends of Science – Providing Insight into Climate Science:  
<<http://www.friendsofscience.org/>>
- Frontiers in Bioscience:  
<<http://www.bioscience.org/atlases/clinical/nomogram/nomoadul.htm>>
- Furtsch, T.A. "Some Notes on Avogadro's Number,  $6.022 \times 10^{23}$ ." Tennessee Technological University: <<http://iweb.tntech.edu/chem281-tf/avogadro.htm>>
- Georgia Perimeter College. Determination of the Length of an Oleic Acid Molecule and Avogadro's Number:  
<<http://www.gpc.edu/~ddonald/chemlab/oleicavagno.html>>

- Glencoe Online. An Internet WebQuest. The Chemistry of Fireworks:  
<<http://www.glencoe.com/sec/science/webquest/content/fireworks.shtml>>
- Greener Industry: <<http://www.greener-industry.org/>>
- HowStuffWorks. How Breathalyzers Work:  
<<http://science.howstuffworks.com/breathalyzer3.htm>>
- Intergovernmental Panel on Climate Change (IPCC): <<http://www.ipcc.ch/>>
- Iowa Health System (IHS). Drug: Anabolic Steroids:  
<<http://www.ihs.org/body.cfm?id=580>>
- Maclean's: <<http://www.macleans.ca>>
- Magma Communications. Doug De La Matter. Experiments with Coins:  
<<http://www.magma.ca/~dougdela/ideas/coindemo.pdf>>
- Manitoba Education, Citizenship and Youth. Learning Resources:  
<<http://www.edu.gov.mb.ca/k12/learnres/bibliographies.html>>
- Manitoba Energy, Science and Technology. Energy Development Initiative. Gasohol Incentives: <<http://www.gov.mb.ca/est/energy/ethanol/ethincentives.html>>
- . ---. Ethanol-Blended Fuels:  
<<http://www.gov.mb.ca/est/energy/initiatives/ethanolfuels.html>>
- Manitoba Water Stewardship Branch:  
<<http://www.gov.mb.ca/waterstewardship/odw/index.html>>
- Material Safety Data Sheet (MSDS). Toluene:  
<<http://www.jtbaker.com/msds/englishhtml/t3913.htm>>
- Michigan State University. Nomenclature: Naming Organic Compounds:  
<<http://www.cem.msu.edu/~reusch/VirtualText4/nomen1.htm>>
- National Defence. Canadian Forces School of Survival and Aeromedical Training (CFSSAT): <[http://www.airforce.forces.ca/17wing/squadron/cfssat\\_e.asp](http://www.airforce.forces.ca/17wing/squadron/cfssat_e.asp)>.
- Natural Resources Canada: <<http://oee.nrcan.gc.ca/transportation/personal-vehicles-initiative.cfm>>
- . Climate Change in Canada. Teacher's Guide:  
<[http://adaptation.nrcan.gc.ca/posters/teachers/resourc\\_e.asp](http://adaptation.nrcan.gc.ca/posters/teachers/resourc_e.asp)>
- . Personal Vehicle Initiative: <<http://oee.nrcan.gc.ca/transportation/personal-vehicles-initiative.cfm>>
- New York State Department of Environmental Conservation. Recycling Plastics Is as Easy as...: <<http://www.dec.state.ny.us/website/dshm/redrecy/plastic.htm>>
- The North Carolina School of Science and Mathematics, Distance Learning Technologies, Teachers' Instructional Graphics Educational Resource (TIGER):  
<<http://www.dlt.ncssm.edu/TIGER/chem3.htm>>.

- Northern Blue Publishing. Canadian History Business News. The Small Canadian Penny: <<http://northernblue.ca/cbushist/index.php?/archives/165-The-Small-Canadian-Penny.html>>
- Nuclear Energy Institute (NEI): <<http://www.nei.org/index.asp?catnum=1&catid=1>>
- Oakley, Burks II. Nitrox Scuba Diving. University of Illinois at Springfield: <<http://www.online.uillinois.edu/oakley/nitrox.html>>
- Obvious Implementations Corporation/Obviously Enterprises. The Internet Consumer Recycling Guide: <<http://www.obviously.com/recycle/>>
- Ohio Department of Natural Resources. Division of Recycling and Litter Prevention. Recycling Plastic: <<http://www.dnr.state.oh.us/recycling/plastics/>>
- PASCO Scientific: <<http://www.pasco.com/hsmanuals/ps2808.html>>
- . Online Science Experiments. Boyle's Law: <[http://www.pasco.com/experiments/chemistry/november\\_2001/home.html](http://www.pasco.com/experiments/chemistry/november_2001/home.html)>
- . Physics Experiment Kits. Ideal Gas Law Experiment # 9954: <<http://www.pasco.com/products/groups/55-372-2.html>>
- The Physics Hypertext. Thermal Physics. Gas Laws: <<http://hypertextbook.com/physics/thermal/gas-laws/>>
- Professional Association of Diving Instructors (PADI): <<http://www.padi.com>>
- Pure Water Products: <<http://www.pwgazette.com/rofaq.htm>>
- Renewable Fuels Association: <<http://www.ethanolrfa.org/>>
- Rod Beavon. F A Kekulé von Stradonitz: <<http://www.rod.beavon.clara.net/kekule.htm>>
- Science Teachers' Resource Center. Oleic Acid Lab: <<http://chem.lapeer.org/chem1docs/OleicAcidLab.html>>
- Summer Research Program for Science Teachers. How Big Is a Molecule? <<http://www.scienceteacherprogram.org/chemistry/Flomberg00.html>>
- SynLube™: <<http://www.synlube.com/synthetic.htm>>
- Thomas J. Greenbowe, Department of Chemistry, Iowa State University: <[http://www.chem.iastate.edu/group/Greenbowe/sections/projectfolder/flashfiles/gaslaw/charles\\_law.html](http://www.chem.iastate.edu/group/Greenbowe/sections/projectfolder/flashfiles/gaslaw/charles_law.html)>
- Topix.net. Alternative Energy News: <<http://www.topix.net/tech/alt-energy>>
- University of Guelph. Bruce J. Holub. Trans Watch: <<http://www.uoguelph.ca/~bholub/trans.html>>

- University of Waterloo. *CHEM 13 NEWS*:  
<<http://www.chemistry.uwaterloo.ca/about/outreach/chem13news/index.html>>
- U.S. Environmental Protection Agency: Radiation Information:  
<<http://www.epa.gov/radiation/radionuclides/tritium.htm>>
- . Recycle City: <<http://www.epa.gov/recyclecity/>>
- . Software for Environmental Awareness (SEAHOME):  
<<http://www.epa.gov/seahome/hwaste.html>>
- U.S. Food and Drug Administration. Revealing *Trans* Fats:  
<[http://www.fda.gov/fdac/features/2003/503\\_fats.html](http://www.fda.gov/fdac/features/2003/503_fats.html)>
- U.S. Geological Survey:  
<[http://www.rcamnl.wr.usgs.gov/isoig/period/h\\_iig.html](http://www.rcamnl.wr.usgs.gov/isoig/period/h_iig.html)>
- Vernier Software and Technology. Chemistry:  
<<http://www.vernier.com/chemistry/>>
- Virginia Commonwealth University. Steroids – Introduction:  
<<http://www.people.vcu.edu/~urdesai/intro.htm#Structure>>
- Waste Online. Plastic Recycling Information Sheet:  
<<http://www.wasteonline.org.uk/resources/InformationSheets/Plastics.htm>>
- WebMD. *Trans* Fats: The Science and the Risks:  
<<http://my.webmd.com/content/article/71/81217.htm>>
- The WebQuest Page: <<http://webquest.sdsu.edu/>>
- Webshells.com. Oil, Chemical and Atomic Workers Union (OCAW). Benzene:  
<<http://www.webshells.com/ocaw/txts/doc999994.htm>>
- The WELL. Web of Addictions. Steroids:  
<<http://www.well.com/user/woa/fsroids.htm>>
- Wikipedia: <[http://en.wikipedia.org/wiki/Fritz\\_Haber](http://en.wikipedia.org/wiki/Fritz_Haber)>
- Williams, Park. Don't Be an Isotope, Learn about an Isotope:  
<<http://www.geog.ucsb.edu/~williams/Isotopes.htm>>.
- World Health Organization. Protection of the Human Environment:  
<<http://www.who.int/phe/en/>>
- York University. The Chemistry Hall of Fame. Benzene: The Parent Aromatic Compound: <[http://www.chem.yorku.ca/hall\\_of\\_fame/essays97/benzene/benzene.htm](http://www.chem.yorku.ca/hall_of_fame/essays97/benzene/benzene.htm)>



Printed in Canada  
Imprimé au Canada