

Grade 7 Mathematics

Support Document for Teachers



GRADE 7 MATHEMATICS

Support Document for Teachers

Manitoba Education and Training Cataloguing in Publication Data

Grade 7 mathematics : support document for teachers

Includes bibliographical references.

This resource is available in print and electronic formats.

ISBN: 978-0-7711-5902-2 (print)

ISBN: 978-0-7711-5903-9 (PDF)

1. Mathematics—Study and teaching (Secondary).
2. Mathematics—Study and teaching (Secondary)—Manitoba.
 - I. Manitoba. Manitoba Education and Training.
372.7044

Copyright © 2016, the Government of Manitoba, represented by the Minister of Education and Training.

Manitoba Education and Training
School Programs Division
Winnipeg, Manitoba, Canada

Every effort has been made to acknowledge original sources and to comply with copyright law. If cases are identified where this has not been done, please notify Manitoba Education and Training. Errors or omissions will be corrected in a future edition. Sincere thanks to the authors, artists, and publishers who allowed their original material to be used.

All images found in this resource are copyright protected and should not be extracted, accessed, or reproduced for any purpose other than for their intended educational use in this resource.

Any websites referenced in this resource are subject to change without notice. Educators are advised to preview and evaluate websites and online resources before recommending them for student use.

Print copies of this resource (stock number 80636) can be purchased from the Manitoba Learning Resource Centre (formerly the Manitoba Text Book Bureau). Order online at www.mtbb.mb.ca.

This resource is also available on the Manitoba Education and Training website at www.edu.gov.mb.ca/k12/cur/math/supports.html.

Available in alternate formats upon request.

CONTENTS

List of Blackline Masters (BLMs)	v
Grade 7 Mathematics Blackline Masters	v
Grades 5 to 8 Mathematics Blackline Masters	viii

Acknowledgements	ix
-------------------------	-----------

Introduction	1
Overview	2
Conceptual Framework for Kindergarten to Grade 9 Mathematics	6
Assessment	10
Instructional Focus	12
Document Organization and Format	13

Number	1
Number—7.N.1	3
Number—7.N.2	19
Number—7.N.3	45
Number—7.N.4	63
Number—7.N.5	85
Number—7.N.6	117
Number—7.N.7	137

Patterns and Relations	1
Patterns and Relations (Patterns, and Variables and Equations)— 7.PR.1, 7.PR.2, 7.PR.3, 7.PR.4, 7.PR.5, 7.PR.6, 7.PR.7	3

Shape and Space	1
Shape and Space (Measurement)—7.SS.1	3
Shape and Space (Measurement)—7.SS.2	23
Shape and Space (3-D Objects and 2-D Shapes)—7.SS.3	43
Shape and Space (Transformations)—7.SS.4	73
Shape and Space (Transformations)—7.SS.5	89

Statistics and Probability	1
Statistics and Probability (Data Analysis)—7.SP.1, 7.SP.2	3
Statistics and Probability (Data Analysis)—7.SP.3	21
Statistics and Probability (Chance and Uncertainty)—7.SP.4, 7.SP.5, 7.SP.6	41

Appendix	1
Models for Computing Decimal Numbers	1

Bibliography	1
---------------------	----------

List of Blackline Masters (BLMs)

Grade 7 Mathematics Blackline Masters

Number (N)

- BLM 7.N.1.1: Math Language Crossword Puzzle (with Answer Key)
- BLM 7.N.1.2: Divisibility Questions
- BLM 7.N.1.3: Applying Divisibility Rules
- BLM 7.N.2.1: Whole and Decimal Number Cards
- BLM 7.N.2.2: Operation Cards
- BLM 7.N.2.3: Equivalent Percent, Fraction, and Decimal Cards (with Answer Key)
- BLM 7.N.2.4: Order of Operations and Skill-Testing Questions
- BLM 7.N.2.5: Money Problems
- BLM 7.N.2.6: Restaurant Bills and Biking
- BLM 7.N.2.7: Sample Scenarios 1
- BLM 7.N.2.8: Sample Scenarios 2
- BLM 7.N.2.9: Sample Scenarios 3
- BLM 7.N.2.10: Decimal Problems
- BLM 7.N.3.1A: Tic-Tac-Toe Frames
- BLM 7.N.3.1B: Tic-Tac-Toe Frames (Medium Challenge)
- BLM 7.N.3.1C: Tic-Tac-Toe Frame (Ultimate Challenge)
- BLM 7.N.3.2: Equivalent Fraction Challenge
- BLM 7.N.3.3: It's Between: Rounding Decimal Numbers
- BLM 7.N.3.4: Choose Your Question
- BLM 7.N.3.5: Designing to Percent Specifications
- BLM 7.N.3.6: Determining the Whole, the Part, the Percent, and What to Find
- BLM 7.N.3.7: Finding the Missing Numbers in the Percent (Scenarios)
- BLM 7.N.3.8: Percent Problems
- BLM 7.N.4.1: Table for Recording Fractions and Their Decimal Equivalents
- BLM 7.N.5.1: Interpreting and Recording Different Meanings of Fractions
- BLM 7.N.5.2: Improper Fraction and Mixed Number Cards
- BLM 7.N.5.3A: Ace Aviation: Adding Fractions
- BLM 7.N.5.3B: Ace Aviation: Subtracting Fractions
- BLM 7.N.5.4A: Representing Recognizable Fractions and Writing Addition Statements
- BLM 7.N.5.4B: Representing Recognizable Fractions and Writing Subtraction Statements
- BLM 7.N.5.5: Adding and Subtracting Fractions (Scenarios)
- BLM 7.N.5.6: Problems Involving Fractions
- BLM 7.N.6.1: Centimetre Number Line
- BLM 7.N.6.2: Integer Football
- BLM 7.N.7.1: Equivalent Fractions and Decimals

BLM 7.N.7.2: Equivalent Fractions, Decimals, and Percents
BLM 7.N.7.3: Comparing Fraction and Decimal Equivalents
BLM 7.N.7.4: Ordering Decimal Numbers
BLM 7.N.7.5: Sequential Fractions and Their Decimal Equivalents
BLM 7.N.7.6: Relating Numbers to Benchmarks
BLM 7.N.7.7: Ordering Numbers and Verifying the Order

Patterns and Relations (PR)

BLM 7.PR.1: Patterns: A Process
BLM 7.PR.2: Sample Patterns
BLM 7.PR.3: Directions for Playing a Relations Game
BLM 7.PR.4: Understanding Concepts in Patterns and Relations
BLM 7.PR.5: Possible Word Pattern Contexts to Match a Relation
BLM 7.PR.6: Formulating Relations to Match Word Descriptions of Patterns
BLM 7.PR.7: Creating Word Descriptions of Patterns and Matching Relations
BLM 7.PR.8: Template for Creating and Solving Problems Using Information from a Graph
BLM 7.PR.9: Associating Clue Words with Operations and Expressions (with Answer Key)
BLM 7.PR.10: Solving Single-Variable One-Step Equations
BLM 7.PR.11: Writing Expressions and Solving Equations That Match Word Descriptions
BLM 7.PR.12A: Representing Equivalent Expressions on a Balance Scale (Sample)
BLM 7.PR.12B: Representing Equivalent Expressions on a Balance Scale (Template)
BLM 7.PR.12C: Representing Equivalent Expressions on a Balance Scale Using Variables for Unknowns (Sample)
BLM 7.PR.12D: Representing Equivalent Expressions on a Balance Scale Using Variables for Unknowns (Template)
BLM 7.PR.12E: Representing Equivalent Expressions (Template)
BLM 7.PR.13: Evaluating Expressions, Given a Value for the Variable
BLM 7.PR.14A: Solving Linear Equations: Pictorial and Symbolic Representations
BLM 7.PR.14B: Solving Linear Equations with Constants: Applying the Preservation of Equality
BLM 7.PR.14C: Solving Linear Equations with Numerical Coefficients: Applying the Preservation of Equality
BLM 7.PR.14D: Solving Linear Equations with Constants and Numerical Coefficients: Applying the Preservation of Equality
BLM 7.PR.15: Problems to Represent with Linear Equations and with Concrete Materials (with Answer Key)

Shape and Space (SS)

- BLM 7.SS.1.1: Assorted Angle Cards
- BLM 7.SS.1.2: Angle Classifications, Angle Estimations and Measures, and Perimeter
- BLM 7.SS.1.3: Cut-outs for Angles of Different Measures
- BLM 7.SS.1.4: Hinge Templates for Making Angles
- BLM 7.SS.1.5: A Table to Compare Measures of Circles
- BLM 7.SS.2.1: The Area of Rectangles (Assessing Prior Knowledge)
- BLM 7.SS.2.2: Circles for Estimating Area
- BLM 7.SS.3.1: Parallel and Perpendicular Lines (Assessing Prior Knowledge)
- BLM 7.SS.3.2: Creating Perpendicular Lines
- BLM 7.SS.3.3: Creating Perpendicular Bisectors
- BLM 7.SS.4.1: Plotting Points on a Cartesian Plane (with Answer Key)
- BLM 7.SS.4.2: Cartesian Plane Quadrant Cards
- BLM 7.SS.4.3: Plot This Picture (with Answer Key)
- BLM 7.SS.5.1: Comparing Points
- BLM 7.SS.5.2: A Coordinate Map
- BLM 7.SS.5.3: Cartesian Plane Map and UFO Templates
- BLM 7.SS.5.4: Exploring Transformations: UFO Pilot Training
- BLM 7.SS.5.5: Recording Transformations: Travel Logbook
- BLM 7.SS.5.6: Creating a Design Using Reflections
- BLM 7.SS.5.7: Which Plot Is Correct?

Statistics and Probability (SP)

- BLM 7.SP.1.1: Finding the Centre of a Graph and Comparing the Values
- BLM 7.SP.1.2: Exploring Measures of Central Tendency
- BLM 7.SP.1.3A: Simone's Spelling Scores (Questions)
- BLM 7.SP.1.3B: Simone's Spelling Performance Record
- BLM 7.SP.1.4: Using Central Tendency to Choose a Quarterback
- BLM 7.SP.3.1: Calculating the Percent of the Total
- BLM 7.SP.3.2: Percent of a Circle
- BLM 7.SP.3.3: Data Chart for Creating Circle Graphs
- BLM 7.SP.3.4: Comparing Examples of Circle Graphs
- BLM 7.SP.3.5: Translating Percentages in a Circle Graph into Quantities
- BLM 7.SP.4.1: Recording Sheet for Fraction–Decimal–Percent Equivalents
- BLM 7.SP.4.2: What Is the Probability?
- BLM 7.SP.4.3: Experimental Probability Tally Sheet and Probability of Outcomes
- BLM 7.SP.5.1: Which Conditions Affect Probability?
- BLM 7.SP.5.2: Examples of Two Independent Events
- BLM 7.SP.6.1: Frequency Chart for Organizing Outcomes for Two Independent Events
- BLM 7.SP.6.2: Probability Problems Involving Two Independent Events

Grades 5 to 8 Mathematics Blackline Masters

- BLM 5–8.1: Observation Form
- BLM 5–8.2: Concept Description Sheet #1
- BLM 5–8.3: Concept Description Sheet #2
- BLM 5–8.4: How I Worked in My Group
- BLM 5–8.5: Number Cards
- BLM 5–8.6: Blank Hundred Squares
- BLM 5–8.7: Place-Value Chart—Whole Numbers
- BLM 5–8.8: Mental Math Strategies
- BLM 5–8.9: Centimetre Grid Paper
- BLM 5–8.10: Base-Ten Grid Paper
- BLM 5–8.11: Multiplication Table
- BLM 5–8.12: Fraction Bars
- BLM 5–8.13: Clock Face
- BLM 5–8.14: Spinner
- BLM 5–8.15: Thousand Grid
- BLM 5–8.16: Place-Value Mat—Decimal Numbers
- BLM 5–8.17: Number Fan
- BLM 5–8.18: KWL Chart
- BLM 5–8.19: Double Number Line
- BLM 5–8.20: Algebra Tiles
- BLM 5–8.21: Isometric Dot Paper
- BLM 5–8.22: Dot Paper
- BLM 5–8.23: Understanding Words Chart
- BLM 5–8.24: Number Line
- BLM 5–8.25: My Success with Mathematical Processes
- BLM 5–8.26: Percent Circle

ACKNOWLEDGEMENTS

Manitoba Education and Training wishes to thank the members of the Grades 5 to 8 Mathematics Support Document Development Team for their contribution to this document. Their dedication and hard work have made this document possible.

Grades 5 to 8 Mathematics Support Document Development Team (2006–2008)	Writer	Lana Landry	Red River Valley Junior Academy
		Holly Forsyth	Fort La Bosse School Division
		Linda Girling	Louis Riel School Division
		Chris Harbeck	Winnipeg School Division
		Heidi Holst	Lord Selkirk School Division
		Steven Hunt	Independent School
		Jan Jebsen	Kelsey School Division
		Betty Johns	University of Manitoba
		Dianna Kicenko	Evergreen School Division
		Kelly Kuzyk	Mountain View School Division
		Judy Maryniuk	Lord Selkirk School Division
		Greg Sawatzky	Hanover School Division
		Darlene Willetts	Evergreen School Division
	Manitoba Education and Training School Programs Division Staff		Heather Anderson Consultant (until June 2007)
		Bob Beaudry Consultant (from January 2016)	Development Unit Instruction, Curriculum and Assessment Branch
		Carole Bilyk Project Manager Coordinator	Development Unit Instruction, Curriculum and Assessment Branch
		Louise Boissonneault Coordinator	Document Production Services Unit Educational Resources Branch
		Linda Girling Consultant (until June 2015)	Development Unit Instruction, Curriculum and Assessment Branch
		Lynn Harrison Desktop Publisher	Document Production Services Unit Educational Resources Branch
	Heather Knight Wells Project Leader	Development Unit Instruction, Curriculum and Assessment Branch	

**Manitoba Education
and Training
School Programs
Division Staff**

Susan Letkemann
Publications Editor

Tim Pohl
Desktop Publisher

Document Production Services Unit
Educational Resources Branch

Document Production Services Unit
Educational Resources Branch

INTRODUCTION

Purpose of This Document

Grade 7 Mathematics: Support Document for Teachers provides various suggestions for instruction, assessment strategies, and learning resources that promote the meaningful engagement of mathematics learners in Grade 7. The document is intended to be used by teachers as they work with students in achieving the learning outcomes and achievement indicators identified in *Kindergarten to Grade 8 Mathematics: Manitoba Curriculum Framework of Outcomes* (2013) (Manitoba Education).

Background

Kindergarten to Grade 8 Mathematics: Manitoba Curriculum Framework of Outcomes is based on *The Common Curriculum Framework for K–9 Mathematics*, which resulted from ongoing collaboration with the Western and Northern Canadian Protocol (WNCP). In its work, WNCP emphasizes

- common educational goals
- the ability to collaborate and achieve common goals
- high standards in education
- planning an array of educational activities
- removing obstacles to accessibility for individual learners
- optimum use of limited educational resources

The growing effects of technology and the need for technology-related skills have become more apparent in the last half century. Mathematics and problem-solving skills are becoming more valued as we move from an industrial to an informational society. As a result of this trend, mathematics literacy has become increasingly important. Making connections between mathematical study and daily life, business, industry, government, and environmental thinking is imperative. The Kindergarten to Grade 12 mathematics curriculum is designed to support and promote the understanding that mathematics is

- a way of learning about our world
- part of our daily lives
- both quantitative and geometric in nature

Beliefs about Students and Mathematics Learning

The Kindergarten to Grade 8 mathematics curriculum is designed with the understanding that students have unique interests, abilities, and needs. As a result, it is imperative to make connections to all students' prior knowledge, experiences, and backgrounds.

Students are curious, active learners with individual interests, abilities, and needs. They come to classrooms with unique knowledge, life experiences, and backgrounds. A key component in successfully developing numeracy is making connections to these backgrounds and experiences.

Students learn by attaching meaning to what they do, and they need to construct their own meaning of mathematics. This meaning is best developed when learners encounter mathematical experiences that proceed from the simple to the complex and from the concrete to the abstract. The use of manipulatives and a variety of pedagogical approaches can address the diversity of learning styles and developmental stages of students, and enhance the formation of sound, transferable mathematical concepts. At all levels, students benefit from working with a variety of materials, tools, and contexts when constructing meaning about new mathematical ideas. Meaningful student discussions can provide essential links among concrete, pictorial, and symbolic representations of mathematics.

Students need frequent opportunities to develop and reinforce their conceptual understanding, procedural thinking, and problem-solving abilities. By addressing these three interrelated components, students will strengthen their ability to apply mathematical learning to their daily lives.

The learning environment should value and respect all students' experiences and ways of thinking, so that learners are comfortable taking intellectual risks, asking questions, and posing conjectures. Students need to explore problem-solving situations in order to develop personal strategies and become mathematically literate. Learners must realize that it is acceptable to solve problems in different ways and that solutions may vary.

Conceptual understanding: comprehending mathematical concepts, relations, and operations to build new knowledge. (Kilpatrick, Swafford, and Findell 5)

Procedural thinking: carrying out procedures flexibly, accurately, efficiently, and appropriately.

Problem solving: engaging in understanding and resolving problem situations where a method or solution is not immediately obvious. (OECD 12)

First Nations, Métis, and Inuit Perspectives

First Nations, Métis, and Inuit students in Manitoba come from diverse geographic areas with varied cultural and linguistic backgrounds. Students attend schools in a variety of settings, including urban, rural, and isolated communities. Teachers need to recognize and understand the diversity of cultures within schools and the diverse experiences of students.

First Nations, Métis, and Inuit students often have a whole-world view of the environment; as a result, many of these students live and learn best in a holistic way. This means that students look for connections in learning, and learn mathematics best when it is contextualized and not taught as discrete content.

Many First Nations, Métis, and Inuit students come from cultural environments where learning takes place through active participation. Traditionally, little emphasis was placed upon the written word. Oral communication along with practical applications and experiences are important to student learning and understanding.

A variety of teaching and assessment strategies are required to build upon the diverse knowledge, cultures, communication styles, skills, attitudes, experiences, and learning styles of students. The strategies used must go beyond the incidental inclusion of topics and objects unique to a culture or region, and strive to achieve higher levels of multicultural education (Banks and Banks).

Affective Domain

A positive attitude is an important aspect of the affective domain that has a profound effect on learning. Environments that create a sense of belonging, encourage risk taking, and provide opportunities for success help students develop and maintain positive attitudes and self-confidence. Students with positive attitudes toward learning mathematics are likely to be motivated and prepared to learn, participate willingly in classroom learning activities, persist in challenging situations, and engage in reflective practices.

Teachers, students, and parents* need to recognize the relationship between the affective and cognitive domains, and attempt to nurture those aspects of the affective domain that contribute to positive attitudes. To experience success, students must be taught to set achievable goals and assess themselves as they work toward reaching these goals.

Striving toward success and becoming autonomous and responsible learners are ongoing, reflective processes that involve revisiting the setting and assessment of personal goals.

* In this document, the term *parents* refers to both parents and guardians and is used with the recognition that in some cases only one parent may be involved in a child's education.

Middle Years Education

Middle Years education is defined as the education provided for young adolescents in Grades 5, 6, 7, and 8. Middle Years learners are in a period of rapid physical, emotional, social, moral, and cognitive development.

Socialization is very important to Middle Years students, and collaborative learning, positive role models, approval of significant adults in their lives, and a sense of community and belonging greatly enhance adolescents' engagement in learning and commitment to school. It is important to provide students with an engaging and social environment within which to explore mathematics and to construct meaning.

Adolescence is a time of rapid brain development when concrete thinking progresses to abstract thinking. Although higher-order thinking and problem-solving abilities develop during the Middle Years, concrete, exploratory, and experiential learning is most engaging to adolescents.

Middle Years students seek to establish their independence and are most engaged when their learning experiences provide them with a voice and choice. Personal goal setting, co-construction of assessment criteria, and participation in assessment, evaluation, and reporting help adolescents take ownership of their learning. Clear, descriptive, and timely feedback can provide important information to the mathematics student. Asking open-ended questions, accepting multiple solutions, and having students develop personal strategies will help students to develop their mathematical independence.

Adolescents who see the connections between themselves and their learning, and between the learning inside the classroom and life outside the classroom, are more motivated and engaged in their learning than those who do not observe these connections.

Adolescents thrive on challenges in their learning, but their sensitivity at this age makes them prone to discouragement if the challenges seem unattainable. Differentiated instruction allows teachers to tailor learning challenges to adolescents' individual needs, strengths, and interests. It is important to focus instruction on where students are and to see every contribution as valuable.

The energy, enthusiasm, and unfolding potential of young adolescents provide both challenges and rewards to educators. Those educators who have a sense of humour and who see the wonderful potential and possibilities of each young adolescent will find teaching in the Middle Years exciting and fulfilling.

Mathematics Education Goals for Students

The main goals of mathematics education are to prepare students to

- communicate and reason mathematically
- use mathematics confidently, accurately, and efficiently to solve problems
- appreciate and value mathematics
- make connections between mathematical knowledge and skills and their applications
- commit themselves to lifelong learning
- become mathematically literate citizens, using mathematics to contribute to society and to think critically about the world

Mathematics education must prepare students to use mathematics to think critically about the world.

Students who have met these goals will

- gain understanding and appreciation of the contributions of mathematics as a science, a philosophy, and an art
- exhibit a positive attitude toward mathematics
- engage and persevere in mathematical tasks and projects
- contribute to mathematical discussions
- take risks in performing mathematical tasks
- exhibit curiosity

CONCEPTUAL FRAMEWORK FOR KINDERGARTEN TO GRADE 9 MATHEMATICS

The chart below provides an overview of how mathematical processes and the nature of mathematics influence learning outcomes.

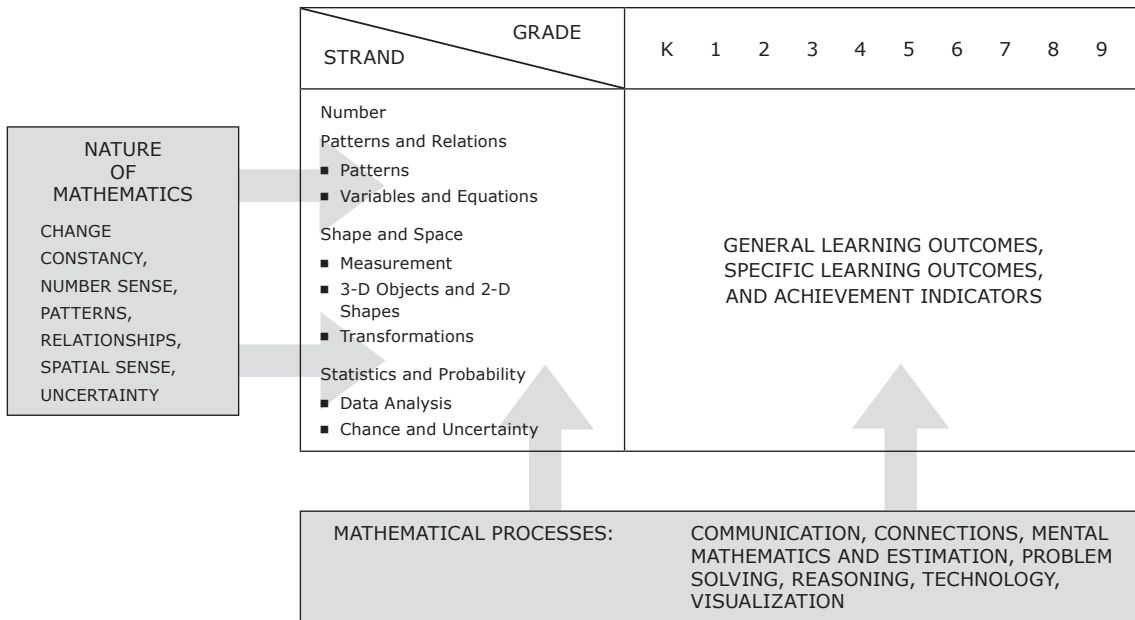

Mathematical Processes

There are critical components that students must encounter in mathematics to achieve the goals of mathematics education and encourage lifelong learning in mathematics.

Students are expected to

- communicate in order to learn and express their understanding
- connect mathematical ideas to other concepts in mathematics, to everyday experiences, and to other disciplines
- demonstrate fluency with mental mathematics and estimation
- develop and apply new mathematical knowledge through problem solving
- develop mathematical reasoning
- select and use technologies as tools for learning and solving problems
- develop visualization skills to assist in processing information, making connections, and solving problems

The common curriculum framework incorporates these seven interrelated mathematical processes, which are intended to permeate teaching and learning:

- **Communication [C]:** Students communicate daily (orally, through diagrams and pictures, and by writing) about their mathematics learning. They need opportunities to read about, represent, view, write about, listen to, and discuss mathematical ideas. This enables them to reflect, to validate, and to clarify their thinking. Journals and learning logs can be used as a record of student interpretations of mathematical meanings and ideas.
- **Connections [CN]:** Mathematics should be viewed as an integrated whole, rather than as the study of separate strands or units. Connections must also be made between and among the different representational modes—concrete, pictorial, and symbolic (the symbolic mode consists of oral and written word symbols as well as mathematical symbols). The process of making connections, in turn, facilitates learning. Concepts and skills should also be connected to everyday situations and other curricular areas.
- **Mental Mathematics and Estimation [ME]:** The skill of estimation requires a sound knowledge of mental mathematics. Both are necessary to many everyday experiences, and students should be provided with frequent opportunities to practise these skills. Mental mathematics and estimation is a combination of cognitive strategies that enhances flexible thinking and number sense.
- **Problem Solving [PS]:** Students are exposed to a wide variety of problems in all areas of mathematics. They explore a variety of methods for solving and verifying problems. In addition, they are challenged to find multiple solutions for problems and to create their own problems.
- **Reasoning [R]:** Mathematics reasoning involves informal thinking, conjecturing, and validating—these help students understand that mathematics makes sense. Students are encouraged to justify, in a variety of ways, their solutions, thinking processes, and hypotheses. In fact, good reasoning is as important as finding correct answers.
- **Technology [T]:** The use of calculators is recommended to enhance problem solving, to encourage discovery of number patterns, and to reinforce conceptual development and numerical relationships. They do not, however, replace the development of number concepts and skills. Carefully chosen computer software can provide interesting problem-solving situations and applications.
- **Visualization [V]:** Mental images help students to develop concepts and to understand procedures. Students clarify their understanding of mathematical ideas through images and explanations.

These processes are outlined in detail in *Kindergarten to Grade 8 Mathematics: Manitoba Curriculum Framework of Outcomes* (2013).

Strands

The learning outcomes in the Manitoba curriculum framework are organized into four strands across Kindergarten to Grade 9. Some strands are further subdivided into substrands. There is one general learning outcome per substrand across Kindergarten to Grade 9.

The strands and substrands, including the general learning outcome for each, follow.

Number

- Develop number sense.

Patterns and Relations

- Patterns
 - Use patterns to describe the world and solve problems.
- Variables and Equations
 - Represent algebraic expressions in multiple ways.

Shape and Space

- Measurement
 - Use direct and indirect measure to solve problems.
- 3-D Objects and 2-D Shapes
 - Describe the characteristics of 3-D objects and 2-D shapes, and analyze the relationships among them.
- Transformations
 - Describe and analyze position and motion of objects and shapes.

Statistics and Probability

- Data Analysis
 - Collect, display, and analyze data to solve problems.
- Chance and Uncertainty
 - Use experimental or theoretical probabilities to represent and solve problems involving uncertainty.

Learning Outcomes and Achievement Indicators

The Manitoba curriculum framework is stated in terms of general learning outcomes, specific learning outcomes, and achievement indicators:

- **General learning outcomes** are overarching statements about what students are expected to learn in each strand/substrand. The general learning outcome for each strand/substrand is the same throughout the grades from Kindergarten to Grade 9.
- **Specific learning outcomes** are statements that identify the specific skills, understanding, and knowledge students are required to attain by the end of a given grade.
- **Achievement indicators** are samples of how students may demonstrate their achievement of the goals of a specific learning outcome. The range of samples provided is meant to reflect the depth, breadth, and expectations of the specific learning outcome. While they provide some examples of student achievement, they are not meant to reflect the sole indicators of success.

In this document, the word *including* indicates that any ensuing items **must be addressed** to meet the learning outcome fully. The phrase *such as* indicates that the ensuing items are provided for illustrative purposes or clarification, and are **not requirements that must be addressed** to meet the learning outcome fully.

Summary

The conceptual framework for Kindergarten to Grade 9 mathematics describes the nature of mathematics, the mathematical processes, and the mathematical concepts to be addressed in Kindergarten to Grade 9 mathematics. The components are not meant to stand alone. Learning activities that take place in the mathematics classroom should stem from a problem-solving approach, be based on mathematical processes, and lead students to an understanding of the nature of mathematics through specific knowledge, skills, and attitudes among and between strands. *Grade 7 Mathematics: Support Document for Teachers* is meant to support teachers to create meaningful learning activities that focus on formative assessment and student engagement.

ASSESSMENT

Authentic assessment and feedback are a driving force for the suggestions for assessment in this document. The purposes of the suggested assessment activities and strategies are to parallel those found in *Rethinking Classroom Assessment with Purpose in Mind: Assessment for Learning, Assessment as Learning, Assessment of Learning* (Manitoba Education, Citizenship and Youth). These include the following:

- assessing *for, as, and of* learning
- enhancing student learning
- assessing students effectively, efficiently, and fairly
- providing educators with a starting point for reflection, deliberation, discussion, and learning

Assessment *for* learning is designed to give teachers information to modify and differentiate teaching and learning activities. It acknowledges that individual students learn in idiosyncratic ways, but it also recognizes that there are predictable patterns and pathways that many students follow. It requires careful design on the part of teachers so that they use the resulting information to determine not only what students know, but also to gain insights into how, when, and whether students apply what they know. Teachers can also use this information to streamline and target instruction and resources, and to provide feedback to students to help them advance their learning.

Assessment *as* learning is a process of developing and supporting metacognition for students. It focuses on the role of the student as the critical connector between assessment and learning. When students are active, engaged, and critical assessors, they make sense of information, relate it to prior knowledge, and use it for new learning. This is the regulatory process in metacognition. It occurs when students monitor their own learning and use the feedback from this monitoring to make adjustments, adaptations, and even major changes in what they understand. It requires that teachers help students develop, practise, and become comfortable with reflection, and with a critical analysis of their own learning.

Assessment *of* learning is summative in nature and is used to confirm what students know and can do, to demonstrate whether they have achieved the curriculum learning outcomes, and, occasionally, to show how they are placed in relation to others. Teachers concentrate on ensuring that they have used assessment to provide accurate and sound statements of students' proficiency so that the recipients of the information can use the information to make reasonable and defensible decisions.

Overview of Planning Assessment			
	Assessment <i>for</i> Learning	Assessment <i>as</i> Learning	Assessment <i>of</i> Learning
Why Assess?	<ul style="list-style-type: none"> to enable teachers to determine next steps in advancing student learning 	<ul style="list-style-type: none"> to guide and provide opportunities for each student to monitor and critically reflect on his or her learning and identify next steps 	<ul style="list-style-type: none"> to certify or inform parents or others of the student's proficiency in relation to curriculum learning outcomes
Assess What?	<ul style="list-style-type: none"> each student's progress and learning needs in relation to the curriculum outcomes 	<ul style="list-style-type: none"> each student's thinking about his or her learning, what strategies he or she uses to support or challenge that learning, and the mechanisms he or she uses to adjust and advance his or her learning 	<ul style="list-style-type: none"> the extent to which each student can apply the key concepts, knowledge, skills, and attitudes related to the curriculum outcomes
What Methods?	<ul style="list-style-type: none"> a range of methods in different modes that make a student's skills and understanding visible 	<ul style="list-style-type: none"> a range of methods in different modes that elicit the student's learning and metacognitive processes 	<ul style="list-style-type: none"> a range of methods in different modes that assess both product and process
Ensuring Quality	<ul style="list-style-type: none"> accuracy and consistency of observations and interpretations of student learning clear, detailed learning expectations accurate, detailed notes for descriptive feedback to each student 	<ul style="list-style-type: none"> accuracy and consistency of a student's self-reflection, self-monitoring, and self-adjustment engagement of the student in considering and challenging his or her thinking the student records his or her own learning 	<ul style="list-style-type: none"> accuracy, consistency, and fairness of judgments based on high-quality information clear, detailed learning expectations fair and accurate summative reporting
Using the Information	<ul style="list-style-type: none"> provide each student with accurate descriptive feedback to further his or her learning differentiate instruction by continually checking where each student is in relation to the curriculum outcomes provide parents or guardians with descriptive feedback about student learning and ideas for support 	<ul style="list-style-type: none"> provide each student with accurate, descriptive feedback that will help him or her develop independent learning habits have each student focus on the task and his or her learning (not on getting the right answer) provide each student with ideas for adjusting, rethinking, and articulating his or her learning provide the conditions for the teacher and student to discuss alternatives the student reports about his or her own learning 	<ul style="list-style-type: none"> indicate each student's level of learning provide the foundation for discussions on placement or promotion report fair, accurate, and detailed information that can be used to decide the next steps in a student's learning

Source: Manitoba Education, Citizenship and Youth. *Rethinking Classroom Assessment with Purpose in Mind: Assessment for Learning, Assessment as Learning, Assessment of Learning*. Winnipeg, MB: Manitoba Education, Citizenship and Youth, 2006, 85.

INSTRUCTIONAL FOCUS

The Manitoba mathematics curriculum framework is arranged into four strands. These strands are not intended to be discrete units of instruction. The integration of learning outcomes across strands makes mathematical experiences meaningful. Students should make the connection between concepts both within and across strands.

Consider the following when planning for instruction:

- Routinely incorporating conceptual understanding, procedural thinking, and problem solving within instructional design will enable students to master the mathematical skills and concepts of the curriculum.
- Integration of the mathematical processes within each strand is expected.
- Problem solving, conceptual understanding, reasoning, making connections, and procedural thinking are vital to increasing mathematical fluency, and must be integrated throughout the program.
- Concepts should be introduced using manipulatives and gradually developed from the concrete to the pictorial to the symbolic.
- Students in Manitoba bring a diversity of learning styles and cultural backgrounds to the classroom and they may be at varying developmental stages. Methods of instruction should be based on the learning styles and abilities of the students.
- Use educational resources by adapting to the context, experiences, and interests of students.
- Collaborate with teachers at other grade levels to ensure the continuity of learning of all students.
- Familiarize yourself with exemplary practices supported by pedagogical research in continuous professional learning.
- Provide students with several opportunities to communicate mathematical concepts and to discuss them in their own words.

“Students in a mathematics class typically demonstrate diversity in the ways they learn best. It is important, therefore, that students have opportunities to learn in a variety of ways—individually, cooperatively, independently, with teacher direction, through hands-on experience, through examples followed by practice. In addition, mathematics requires students to learn concepts and procedures, acquire skills, and learn and apply mathematical processes. These different areas of learning may involve different teaching and learning strategies. It is assumed, therefore, that the strategies teachers employ will vary according to both the object of the learning and the needs of the students” (Ontario 24).

DOCUMENT ORGANIZATION AND FORMAT

This document consists of the following sections:

- **Introduction:** The Introduction provides information on the purpose and development of this document, discusses characteristics of and goals for Middle Years learners, and addresses Aboriginal perspectives. It also gives an overview of the following:
 - **Conceptual Framework for Kindergarten to Grade 9 Mathematics:** This framework provides an overview of how mathematical processes and the nature of mathematics influence learning outcomes.
 - **Assessment:** This section provides an overview of planning for assessment in mathematics, including assessment *for, as, and of* learning.
 - **Instructional Focus:** This discussion focuses on the need to integrate mathematics learning outcomes and processes across the four strands to make learning experiences meaningful for students.
 - **Document Organization and Format:** This overview outlines the main sections of the document and explains the various components that comprise the various sections.
- **Number:** This section corresponds to and supports the Number strand for Grade 7 from *Kindergarten to Grade 8 Mathematics: Manitoba Curriculum Framework of Outcomes (2013)*.
- **Patterns and Relations:** This section corresponds to and supports the Patterns and Variables and Equations substrands of the Patterns and Relations strand for Grade 7 from *Kindergarten to Grade 8 Mathematics: Manitoba Curriculum Framework of Outcomes (2013)*.
- **Shape and Space:** This section corresponds to and supports the Measurement, 3-D Objects and 2-D Shapes, and Transformations substrands of the Shape and Space strand for Grade 7 from *Kindergarten to Grade 8 Mathematics: Manitoba Curriculum Framework of Outcomes (2013)*.
- **Statistics and Probability:** This section corresponds to and supports the Data Analysis and Chance and Uncertainty substrands of the Statistics and Probability strand for Grade 7 from *Kindergarten to Grade 8 Mathematics: Manitoba Curriculum Framework of Outcomes (2013)*.
- **Blackline Masters (BLMs):** Blackline masters are provided to support student learning. They are available in *Microsoft Word* format so that teachers can alter them to meet students' needs, as well as in *Adobe PDF* format.
- **Bibliography:** The bibliography lists the sources consulted and cited in the development of this document.

Guide to Components and Icons

Each of the sections supporting the strands of the Grade 7 Mathematics curriculum includes the components and icons described below.

Enduring Understanding(s):

These statements summarize the core idea of the particular learning outcome(s). Each statement provides a conceptual foundation for the learning outcome. It can be used as a pivotal starting point in integrating other mathematics learning outcomes or other subject concepts. The integration of concepts, skills, and strands remains of utmost importance.

General Learning Outcome(s):

General learning outcomes (GLOs) are overarching statements about what students are expected to learn in each strand/substrand. The GLO for each strand/substrand is the same throughout Kindergarten to Grade 8.

SPECIFIC LEARNING OUTCOME(S):	ACHIEVEMENT INDICATORS:
<p>Specific learning outcome (SLO) statements define what students are expected to achieve by the end of the grade.</p> <p>A code is used to identify each SLO by grade and strand, as shown in the following example:</p> <p>7.N.1 The first number refers to the grade (Grade 7).</p> <p>↑ ↑ ↑ — — The letter(s) refer to the strand (Number). — — The last number indicates the SLO number. [C, CN, ME, PS, R, T, V]</p> <p>Each SLO is followed by a list indicating the applicable mathematical processes.</p>	<p>Achievement indicators are examples of a representative list of the depth, breadth, and expectations for the learning outcome. The indicators may be used to determine whether students understand the particular learning outcome. These achievement indicators will be addressed through the learning activities that follow.</p>

PRIOR KNOWLEDGE

Prior knowledge is identified to give teachers a reference to what students may have experienced previously.

RELATED KNOWLEDGE

Related knowledge is identified to indicate the connections among the Grade 7 Mathematics learning outcomes.

BACKGROUND INFORMATION

Background information is provided to give teachers knowledge about specific concepts and skills related to the particular learning outcome(s).

MATHEMATICAL LANGUAGE

Lists of terms students will encounter while achieving particular learning outcomes are provided. These terms can be placed on mathematics word walls or used in a classroom mathematics dictionary. *Kindergarten to Grade 8 Mathematics Glossary: Support Document for Teachers* (Manitoba Education, Citizenship and Youth) provides teachers with an understanding of key terms found in Kindergarten to Grade 8 mathematics. The glossary is available on the Manitoba Education and Training website at www.edu.gov.mb.ca/k12/cur/math/supports.html.

LEARNING EXPERIENCES

Suggested instructional strategies and assessment ideas are provided for the specific learning outcomes and achievement indicators. In general, learning activities and teaching strategies related to specific learning outcomes are developed individually, except in cases where it seems more logical to develop two or more learning outcomes together. Suggestions for assessment include information that can be used to assess students' progress in their understanding of a particular learning outcome or learning experience.



Assessing Prior Knowledge

Suggestions are provided to assess students' prior knowledge and to help direct instruction.

Observation Checklist

Checklists are provided for observing students' responses during lessons.

Suggestions for Instruction

- **Achievement indicators appropriate to particular learning experiences are listed.**

The instructional suggestions include the following:

- **Materials/Resources:** Outlines the resources required for a learning activity.
- **Organization:** Suggests groupings (individual, pairs, small group, and/or whole class).
- **Procedure:** Outlines detailed steps for implementing suggestions for instruction.

Some learning activities make use of BLMs, which are found in the Blackline Masters section in *Microsoft Word* and *Adobe PDF* formats.

PUTTING THE PIECES TOGETHER



Putting the Pieces Together tasks, found at the end of the learning outcomes, consist of a variety of assessment strategies. They may assess one or more learning outcomes across one or more strands and may make cross-curricular connections.



GRADE 7 MATHEMATICS

Number

Number (7.N.1)

Enduring Understanding(s):

Number sense and mental mathematics strategies are used to estimate answers and lead to flexible thinking.

General Learning Outcome(s):

Develop number sense.

SPECIFIC LEARNING OUTCOME(S):	ACHIEVEMENT INDICATORS:
<p>7.N.1 Determine and explain why a number is divisible by 2, 3, 4, 5, 6, 8, 9, or 10, and why a number cannot be divided by 0. [C, R]</p>	<ul style="list-style-type: none">→ Determine if a number is divisible by 2, 3, 4, 5, 6, 8, 9, or 10, and explain why.→ Sort a set of numbers based upon their divisibility using organizers, such as Venn or Carroll diagrams.→ Determine the factors of a number using the divisibility rules.→ Explain, using an example, why numbers cannot be divided by 0.

PRIOR KNOWLEDGE

Students may have had experience with the following:

- Determining addition facts and related subtraction facts (to 18).
- Explaining the properties of 0 and 1 for multiplication, and the property of 1 for division.
- Describing and applying mental mathematics strategies, such as
 - skip-counting from a known fact
 - using doubling or halving
 - using doubling and adding one more group
 - using patterns in the 9s facts
 - using repeated doubling

to develop recall of basic multiplication facts to 9×9 and related division facts.

- Demonstrating an understanding of multiplication to solve problems by
 - using personal strategies for multiplication with and without concrete materials
 - using arrays to represent multiplication
 - connecting concrete representations to symbolic representations
 - estimating products
- Demonstrating an understanding of division to solve problems by
 - using personal strategies for dividing with and without concrete materials
 - estimating quotients
 - relating division to multiplication
 - interpreting remainders
- Identifying and explaining mathematical relationships using charts and diagrams to solve problems.
- Applying mental mathematics strategies for multiplication, such as
 - annexing, then adding zeros
 - halving and doubling
 - using the distributive property
- Demonstrating an understanding of place value for numbers
 - greater than one million
 - less than one-thousandth
- Demonstrating an understanding of factors and multiples by
 - determining multiples and factors of numbers less than 100
 - identifying prime and composite numbers
 - solving problems involving factors or multiples

For more information on prior knowledge, refer to the following resource:

Manitoba Education and Advanced Learning. *Glance Across the Grades: Kindergarten to Grade 9 Mathematics*. Winnipeg, MB: Manitoba Education and Advanced Learning, 2015. Available online at www.edu.gov.mb.ca/k12/cur/math/glance_k-9/index.html.

BACKGROUND INFORMATION

Divisibility

A dividend is considered to be divisible by a divisor if it can be divided by that divisor to make a quotient that is a whole number (with no remainders).

Example:

36 is divisible by 4 because it gives 9 sets, with no remainders.

If a dividend is divisible by a divisor, that divisor is a factor of the dividend.

Example:

Since 36 is divisible by 4, 4 is a factor of 36.

Since the divisor is a factor of the dividend, the dividend is a multiple of the divisor.

Example:

Since 4 is a factor of 36, 36 is a multiple of 4.

If a number is divisible by more than two factors, it is also divisible by the product of any combination of its prime factors.*

Example:

36 is divisible by both 2 and 3.

2 and 3 are both prime factors, so 36 is also divisible by 6, the product of those two prime factors ($2 \times 3 = 6$).

A clear grasp of divisibility is fundamental to achieving many other learning outcomes.

It helps students to identify factors and understand relationships between numbers. It makes it easier for them to solve problems, sort numbers, work with fractions, understand percents and ratios, and work with algebraic equations. When students can identify factors with ease, they can readily identify prime and composite numbers, identify common factors and multiples, and find both the greatest common factors and the least common multiples. Understanding divisibility enhances students' ability to rename fractions with common denominators and to represent fractions in lowest terms, thereby making it easier for them to compare fractions and to perform operations with fractions.

If students understand place value and have facility in using mental mathematics strategies and facts, it will be easier for them to find patterns in multiples of factors, to add the digits of multiples, and to recognize numbers that are divisible by a particular factor. Proficiency with these skills will help students to discover divisibility rules, understand and explain why divisibility rules work, and use divisibility rules effectively to determine divisibility.

*** Note:**

In Grade 7, students are not formally exposed to prime factorization. It is an achievement indicator in Grade 8 Mathematics in the study of squares and square roots, and a learning outcome in Grade 10 Introduction to Applied and Pre-Calculus Mathematics.

Understanding divisibility rules and the reasons why the rules work increases students' number sense and their understanding of our number system and patterns within the system. Exploring these relationships and developing divisibility rules or explanations for the rules can be challenging and time-consuming, but will provide students with rich opportunities to practise the mathematical processes of problem solving, reasoning, making connections, and communicating. When selecting learning experiences, verify that students have the required background knowledge and skills, clearly outline the tasks and expectations, provide a warm-up learning activity with the simpler factors (e.g., 2, 5, 10), and provide appropriate hints to guide student discovery without being prescriptive.

Divisibility Rules

Below are some possible divisibility rules for common factors, along with explanations and examples. Provide students with opportunities to make their own discoveries and to develop their understanding through learning experiences, rather than asking them to memorize the divisibility rules.

Divisibility Rules for Common Factors			
Divisible by	Rule	Explanation	Examples and Non-examples
2	The number is even. OR The final digits are 2, 4, 6, 8, or 0.	Even numbers are composed of groups of 2. Therefore, it is necessary only to examine the units (or ones) place when determining divisibility by 2.	<ul style="list-style-type: none"> ■ 238 is divisible by 2 because the digit in the units place (8) is even. ■ 89 is not divisible by 2 because the digit in the units place (9) is odd.
3	The sum of the digits is divisible by 3. Continually adding the digits until you end up with a single digit will ultimately result in a total of 3, 6, or 9.	<p>Use place value and the logic of remainders.</p> <ul style="list-style-type: none"> ■ Each hundred can be divided into 33 groups of 3 and leaves 1 unit remaining. ■ Each ten divides into three groups of 3 and leaves 1 unit remaining. ■ The ones are already individual units. <p>Add all the remaining units (or remainders). If this sum divides evenly by 3, the original number is divisible by 3.</p>	<ul style="list-style-type: none"> ■ 351 is divisible by 3 because dividing 3 hundreds by 3 leaves 3 units remaining, 5 tens leaves 5 units remaining, and 1 unit is the remainder in the units place. Add up the remainders: $3 + 5 + 1 = 9$. Since the remainders are divisible by 3, the entire number is divisible by 3. ■ 238 is not divisible by 3 because dividing 2 hundreds by 3 leaves 2 units remaining, 3 tens leaves 3 units remaining, and 8 units are the units remainder. Add up the remainders: $2 + 3 + 8 = 13$; $1 + 3 = 4$. Since 4 is not divisible by 3, the entire number is not.

(continued)

Divisibility Rules for Common Factors (continued)			
Divisible by	Rule	Explanation	Examples and Non-examples
4	The number formed by the final two digits is divisible by 4. OR The number formed by the final two digits is divisible by 2 twice.	Use place value logic. 100 is the smallest place value position divisible by 4 ($100 \div 4 = 25$). Any number greater than 100 can be expressed as x number of hundreds. Therefore, only the number formed by the digits in the tens and units places must be examined.	<ul style="list-style-type: none"> ■ 524 is divisible by 4 because 100 is divisible by 4, and so 5×100 is divisible by 4, and 24 is divisible by 4. ■ 490 is not divisible by 4. Although 4×100 is divisible by 4, 90 is not divisible by 2 twice (not divisible by 4).
5	The final digit is 0 or 5.	Use place value logic. Every group of 10 forms two groups of 5. Therefore, it is necessary only to examine the units (or ones) place when determining divisibility by 5.	<ul style="list-style-type: none"> ■ 130 is divisible by 5 because the digit in the ones place (0) is 0 or 5. ■ 89 is not divisible by 5 because the digit in the ones place (9) is not 0 or 5.
6	The number is even and divisible by 3. OR The number has both 2 and 3 as factors (is divisible by both 2 and 3).	If the number is divisible by both the prime factors 2 and 3, it must also be divisible by 6 because two groups of 3 make a group of 6.	<ul style="list-style-type: none"> ■ 426 is divisible by 6 because it is divisible by both 2 (it is an even number) and 3 (the sum of its digits is divisible by 3). ■ 153 is not divisible by 6 because it is not divisible by 2 (it is an odd number), but it is divisible by 3 (the sum of its digits is divisible by 3).
8	The number formed by the final three digits is divisible by 8. OR The number formed by the final three digits is divisible by 2 three times.	Use place value logic. 1000 is the smallest place value position divisible by 8 ($1000 \div 8 = 125$). Any number larger than 1000 can be expressed as x number of thousands. Therefore, only the number formed by the digits in the hundreds, tens, and units places must be examined.	<ul style="list-style-type: none"> ■ 7480 is divisible by 8 because 480 is divisible by 2 three times ($480 \div 2 = 240$; $240 \div 2 = 120$; $120 \div 2 = 60$). ■ 3220 is not divisible by 8 because 220 is not divisible by 8.

(continued)

Divisibility Rules for Common Factors (continued)			
Divisible by	Rule	Explanation	Examples and Non-examples
9	The sum of the digits is divisible by 9. OR The number is divisible by 3 twice.	Use place value and the logic of remainders. <ul style="list-style-type: none"> Each hundred can be divided into 11 groups of 9 and leaves 1 unit remaining. Each ten divides into one group of 9 and leaves 1 unit remaining. The ones are already individual units. Add all the remaining units (or remainders). If this sum divides evenly by 9, the original number is divisible by 9.	<ul style="list-style-type: none"> 351 is divisible by 9 because dividing 3 hundreds by 9 leaves 3 units remaining, 5 tens leaves 5 units remaining, and 1 unit is the remainder in the units place. Add up the remainders: $3 + 5 + 1 = 9$. Since the remainders are divisible by 9, the entire number is. 418 is not divisible by 9 because dividing 4 hundreds by 9 leaves 4 units remaining, 1 ten leaves 1 unit remaining, and 8 units are the remainder in the units place. Add up the remainders: $4 + 1 + 8 = 13$. Since 13 is not divisible by 9, the entire number is not.
10	The final digit is 0.	All written multiples of 10 end in 0.	<ul style="list-style-type: none"> 130 is divisible by 10 because the digit in the ones place (0) is 0. 89 is not divisible by 10 because the digit in the ones place (9) is not 0.

The following are ways to show a number cannot be divided by zero:

- Using a calculator to divide a number by zero results in an error message.
- Applying the action of division results in an impossible situation.

Example:

If you have a quantity x , how many groups of zero can you make? You would be trying to make groups of zero forever. If you had to share a quantity into zero groups, you would have no groups to share the quantity with. Both scenarios are impossible.

Using the pattern and logic of related facts provides no solution to dividing by zero. Multiplication and division are inverse operations. Think of related statements such as the following:

$$4 \times 2 = 8 \text{ and } 8 \div 4 = 2$$

$$0 \times ? = 8 \text{ and } 8 \div 0 = ? \text{ (There is no answer.)}$$

MATHEMATICAL LANGUAGE

addend
Carroll diagram
difference
dividend
divisibility
divisible
divisor
factor
multiple
prime
product
quotient
sum
Venn diagram

LEARNING EXPERIENCES



Assessing Prior Knowledge

Materials:

- BLM 7.N.1.1: Math Language Crossword Puzzle
- grid paper (optional)

Organization: Individual, pairs, whole class

Procedure:

1. Distribute copies of BLM 7.N.1.1: Math Language Crossword Puzzle. Have students read the clues and complete the puzzle. Students may consult references for assistance in using mathematical terms.
2. After giving students sufficient time to complete the puzzle, have them share their answers. Discuss responses as a class. Encourage students to ask questions, explain their responses, or extend the concepts.

Variations:

- Include or omit the word bank found on BLM 7.N.1.1: Math Language Crossword Puzzle.
- Supply students with mathematical terms and have them create clues and puzzles using online puzzle generators or grid paper.

Sample Website:

Crossword Puzzle Games. *Create a Crossword Puzzle*. 2003.
www.crosswordpuzzlegames.com/create.html.

Observation Checklist

- Listen to and observe students' responses to determine whether students can do the following:
 - Respond correctly to the mathematical terms when hearing or reading them.
 - Use the terms appropriately in comments.

Suggestions for Instruction

- **Determine if a number is divisible by 2, 3, 4, 5, 6, 8, 9, or 10, and explain why.**
- **Sort a set of numbers based upon their divisibility using organizers, such as Venn or Carroll diagrams.**

Materials:

- BLM 7.N.1.2: Divisibility Questions
- math journals or notebooks
- BLM 5–8.11: Multiplication Table (optional)
- calculators (optional)

For additional problems, refer to the following books:

Sachar, Louis. *More Sideways Arithmetic from Wayside School*. New York, NY: Scholastic Inc., 1994.

———. *Sideways Arithmetic from Wayside School*. New York, NY: Scholastic Inc., 1989.

Organization: Individual, pairs or small groups, whole class

Procedure:

1. Distribute copies of BLM 7.N.1.2: Divisibility Questions for students to complete. Students will need to use mental mathematics strategies, as well as Venn and Carroll diagrams.
2. Have students work alone at first, answering as many questions as they can.
3. Then have students work in pairs or in small groups to see whether they can answer more questions together, making sure each student is able to explain the solutions.
4. After students have had sufficient time to work on the questions, have them gather as a class to share responses and reasoning.
5. Have each student create a question similar to the questions on the BLM.
6. Have students select one problem to solve, and ask them to explain their solution in their math journals or notebooks.

Variation:

- If necessary, allow some students to use multiplication charts (e.g., BLM 5–8.11: Multiplication Table), array charts, or calculators. Allow students to use the constant key on a calculator to generate multiples.

**Observation Checklist**

- Listen to and observe students' responses to determine whether students can do the following:
 - Use a repertoire of mental mathematics strategies.
 - Multiply and divide numbers.
 - Understand place value and rename numbers (e.g., the number 65 432 has 654 hundreds and 32 units).
 - Identify multiples and factors of a number.
 - Use Venn and Carroll diagrams to represent relations between number sets.
 - Communicate mathematically.

Suggestions for Instruction

- **Determine if a number is divisible by 2, 3, 4, 5, 6, 8, 9, or 10, and explain why.**
- **Sort a set of numbers based upon their divisibility using organizers, such as Venn or Carroll diagrams.**

Materials:

- display board
- calculators

Organization: Whole class

Procedure:

1. Challenge the class to a teacher-versus-students contest to see who can determine whether a particular number is divisible by a designated factor (1 to 10).
2. Name a factor.
3. Have a student secretly write a number (two to six digits) on a display board.
4. Designate two students to use calculators to verify the correct response. (Yes, it is divisible, or no, it is not divisible.)
5. Reveal the number and begin the contest.
6. Whoever replies correctly first, wins.
7. Keep score if you wish (teacher versus students). Before long, you will dazzle them with your speed, and pique their curiosity. Stop the game when it becomes evident to students that there is a “trick” to this.



Observation Checklist

- Listen to and observe students' responses to determine whether students can do the following:
 - Sort numbers according to their divisibility.
 - Apply reasoning skills and knowledge of number properties and operations to develop a personal meaning for the divisibility of a number by 2, 3, 4, 5, 6, 8, 9, or 10.
 - Communicate mathematically.

Suggestions for Instruction

- **Determine if a number is divisible by 2, 3, 4, 5, 6, 8, 9, or 10, and explain why.**
- **Sort a set of numbers based upon their divisibility using organizers, such as Venn or Carroll diagrams.**

Materials:

- 100 Board, available from the following website:
Manitoba Education. "Middle Years Activities and Games." *Mathematics*.
www.edu.gov.mb.ca/k12/cur/math/my_games/index.html
- BLM 5-8.6: Blank Hundred Squares
- counters
- pencil crayons or markers
- math journals or notebooks
- calculators
- Venn diagram or Carroll diagram templates (optional)

Organization: Whole class, individual, pairs, small groups

Guided Discovery:

As some of the explorations in this three-part learning experience may not be intuitive for students, the following suggestions are meant to help you prepare for this guided discovery:

- Students can use patterns and relations to create generalizations about numbers that are divisible by the factor, and then test the universality of their predictions.
- Challenge students to explain why their divisibility rules work.
- Lead students to discover simple practical tests that can be applied to any number to determine easily whether the number is divisible by the factors 2, 3, 4, 5, 6, 8, 9, or 10.
- List multiples of a factor. Begin with the first 10 multiples of the factor, and look for patterns. If no patterns appear, extend the list of multiples.
- Circle multiples on either BLM 5-8.6: Blank Hundred Squares or a 100 Board to reveal patterns.
- Look for further patterns or relations that may include place values, even or odd final digits, similarities in the final two or final three digits, and similarities in the sums of digits and their common factors.

Procedure:

The following procedure will take place over the course of several classes.

Part A: Divisibility by 10, 5, and 2

1. As a class, begin with the following question:

How can we know which numbers are divisible by 10?

Hints:

- Choose one colour marker, work with BLM 5–8.6: Blank Hundred Squares, and circle all the multiples of 10. Examine the multiples. What do you notice?
- Test your idea on larger numbers. Divide numbers ending in zero by 10 to ensure there are no remainders. Then try dividing numbers that do not end in zero by 10 to prove there are remainders.

2. Discuss students’ responses to the question. (Using the Think-Pair-Share strategy with a partner may help students prepare for whole-class discussion. Students think about the question individually, discuss their ideas with a partner, and then share their responses with the class.) If students reply that all the ones digits are 0, ask them how they know this or how they could prove it to someone who did not agree.

The test results could be shown in a Carroll diagram to illustrate the test’s reliability.

Example:

	Divisible by 10	Not Divisible by 10
Numbers with 0 units	All examples will be here	
Numbers with other than 0 units		All examples will be here

3. Ask students why the test works.
4. Following the discussion, have students record their findings in their math journals, using words, pictures, diagrams, or symbols, or create a Divisibility Study Booklet.

Divisibility rule for the factor _____

This rule works because . . .

5. Repeat steps 1 to 4 for the following question:

How can we know a number is divisible by 5?

Aim for less teacher guidance and more student control of the discussion. Remind students to write a summative journal entry.

6. Repeat steps 1 to 4 for the following question:

How can we know a number is divisible by 2?

Again, aim for less teacher guidance and more student control of the discussion. Remind students to write a summative journal entry.

Part B: Divisibility by 4, 8, 3, 9, and 6

After working through the examples in Part A, students will have a general idea of how to determine whether a number is divisible by a specific factor. Further ideas on how to proceed are provided below, in a suggested order.

1. How can we know which numbers are divisible by 4?

This is a subset of the numbers divisible by 2, so students can continue their findings about factors of 2. Every second multiple of 2 is a factor of 4. It may be helpful to consider that 100 is divisible by 4.

2. Determine whether a number is divisible by 8.

Simply apply and extend the same strategies. 1000 is divisible by 8. Show multiples of 2 and 4 and 8 in a Venn diagram.

3. Determine whether a number is divisible by 3.

Consider making groups of 3 for each place value in each multiple, and then include multiples with three or more digits. Repeat the process with numbers that are not multiples of 3. Consider what happens to the remaining units as you group each place value. Next, examine the sums of the digits in the multiples. Arrange the multiples according to the sums. Look for patterns. Put patterns into charts, or sort them with Venn or Carroll diagrams.

4. Determine whether a number is divisible by 9.

Apply the strategies used for the factor 3.

5. Determine whether a number is divisible by 6.

This set contains numbers divisible by both 2 and 3. Consider using a Venn diagram to show the intersection.

Ensure students record their rules and explanations in their math journals or notebooks, or in their Divisibility Study Booklets, and that they make any desired additions or changes during whole-class discussion.

Part C: Communicating Ideas

1. Inform students that to celebrate and consolidate the learning resulting from this inquiry, they will create a display of their divisibility rules, with brief explanations of why their rules work.
2. Allow displays to be small and personal. They may be created individually or in small groups, with tasks divided among group members. Create a larger wall display.
3. The class could organize a divisibility challenge event.



Observation Checklist

- Listen to and observe students' responses to determine whether students can do the following:
 - Sort numbers according to their divisibility.
 - Apply reasoning skills and knowledge of number properties and operations to develop a personal meaning for the divisibility of a number by 2, 3, 4, 5, 6, 8, 9, or 10.
 - Communicate mathematically.

Suggestions for Instruction

- **Explain, using an example, why numbers cannot be divided by 0.**

Materials:

- calculators
- math journals or notebooks
- counters

Organization: Individual

Procedure:

1. Let students know that they will explore divisibility by zero.
2. Ask students to divide numbers by zero on their calculators and record the results in their math journals. Have them explain why they think there is an error message.
3. Ask students to review the meaning of *division* and to model division by some factor using concrete materials (e.g., counters) or a diagram. Next, ask students to model division using zero as a factor (divisor) and to record their discovery in their math journals.
4. Ask students to create a table of multiplication facts for a given product, and then to write the related division statements. Next, ask students to find $0 \times \underline{\quad} =$ that product and the related division fact. (There is no answer.)

Example:

Multiplication Facts	Related Division Facts
$4 \times \underline{3} = 12$	$12 \div 4 = \underline{3}$
$3 \times \underline{4} = 12$	$12 \div 3 = \underline{4}$
$2 \times \underline{6} = 12$	$12 \div 2 = \underline{6}$
$1 \times \underline{12} = 12$	$12 \div 1 = \underline{12}$
$0 \times \underline{\text{not possible}} = 12$	$12 \div 0 = \underline{\text{not possible}}$

5. Have students record in their math journals what they have discovered about dividing by zero, and then ask them to answer the following question:

Based on what you have discovered, do you think there should be a divisibility rule for zero? Explain your response.



Observation Checklist

- Listen to and observe students' responses to determine whether students can do the following:
 - Determine that a number cannot be divided by zero.
 - Explain, using examples, that a number cannot be divided by zero.

Suggestions for Instruction

- **Determine if a number is divisible by 2, 3, 4, 5, 6, 8, 9, or 10, and explain why.**
- **Determine the factors of a number using the divisibility rules.**

Materials:

- BLM 7.N.1.3: Applying Divisibility Rules
- display board
- pens or markers of different colours
- math journals or notebooks

Organization: Individual, pairs or small groups, whole class

Procedure:

1. Distribute copies of BLM 7.N.1.3: Applying Divisibility Rules.
2. Write 10 numbers on the display board.
3. Allow students to choose any five of the numbers and complete the table provided on BLM 7.N.1.3: Applying Divisibility Rules.
4. After giving students time for individual work, assign pairs or small groups of students one of the questions to present to the class. Have them meet to discuss their response and to determine how they arrived at their answer, how they know their answer is correct, and how they will present their question and response.
5. During the class presentations, the audience members may ask questions of the presenters, or share their opinions. They may make desired adjustments to their own papers as they participate in the discussion. (Using writing instruments of different colours reveals what new knowledge or connections were acquired during that time.)
6. Have students respond to the following in their math journals:

Determine which digit(s) could be placed in the following number to make it divisible by 2, 3, and 9:

23 8__4

Explain your thinking.



Observation Checklist

- Listen to and observe students' responses to determine whether students can do the following:
 - Demonstrate proficiency with a variety of divisibility rules.
 - Use divisibility rules to determine factors of numbers.

Number (7.N.2)

Enduring Understanding(s):

The principles of operations and algorithms used with whole numbers also apply to operations with decimals, fractions, and integers.

Number sense and mental mathematics strategies are used to estimate answers and lead students to develop personal algorithms.

General Learning Outcome(s):

Develop number sense.

SPECIFIC LEARNING OUTCOME(S):	ACHIEVEMENT INDICATORS:
<p>7.N.2 Demonstrate an understanding of the addition, subtraction, multiplication, and division of decimals to solve problems (for more than 1-digit divisors or 2-digit multipliers, technology could be used). [ME, PS, T]</p>	<ul style="list-style-type: none">→ Solve a problem involving the addition of two or more decimal numbers.→ Solve a problem involving the subtraction of decimal numbers.→ Solve a problem involving the multiplication or division of decimal numbers (for more than 1-digit divisors or 2-digit multipliers, technology could be used).→ Place the decimal in a sum or difference using front-end estimation (e.g., for $4.5 + 0.73 + 256.458$, think $4 + 256$, so the sum is greater than 260).→ Place the decimal in a product using front-end estimation (e.g., for $\\$12.33 \times 2.4$, think $\\$12 \times 2$, so the product is greater than \$24).→ Place the decimal in a quotient using front-end estimation (e.g., for $51.50 \text{ m} \div 2.1$, think $50 \text{ m} \div 2$, so the quotient is approximately 25 m).→ Check the reasonableness of answers using estimation.→ Solve a problem that involves operations on decimals (limited to thousandths), taking into consideration the order of operations.→ Explain, using an example, how to use mental mathematics for products or quotients when the multiplier or the divisor is 0.1 or 0.5 or 0.25.

PRIOR KNOWLEDGE

Students may have had experience with the following:

- Describing and applying mental mathematics strategies for adding two 2-digit numerals, such as
 - adding from left to right
 - taking one addend to the nearest multiple of 10 and then compensating
 - using doubles
- Describing and applying mental mathematics strategies for subtracting two 2-digit numerals, such as
 - taking the subtrahend to the nearest multiple of 10 and then compensating
 - thinking of addition
 - using doubles
- Describing and applying mental mathematics strategies, such as
 - skip-counting from a known fact
 - using doubling or halving
 - using doubling and adding one more group
 - using patterns in the 9s facts
 - using repeated doublingto develop recall of basic multiplication facts to 9×9 and related division facts.
- Applying estimation strategies, including
 - front-end rounding
 - compensation
 - compatible numbersin problem-solving contexts.
- Applying mental mathematics strategies for multiplication, such as
 - annexing, then adding zeros
 - halving and doubling
 - using the distributive property
- Demonstrating an understanding of multiplication (2-digit numerals by 2-digit numerals) to solve problems.
- Demonstrating an understanding of division (3-digit numerals by 1-digit numerals) with and without concrete materials, and interpret remainders to solve problems.
- Describing and representing decimals (tenths, hundredths, thousandths) concretely, pictorially, and symbolically.
- Demonstrating an understanding of addition and subtraction of decimals (limited to thousandths).

- Demonstrating an understanding of place value for numbers
 - greater than one million
 - less than one-thousandth
- Solving problems involving large numbers, using technology.
- Demonstrating an understanding of percent (limited to whole numbers) concretely, pictorially, and symbolically.
- Demonstrating an understanding of multiplication and division of decimals involving
 - 1-digit whole-number multipliers
 - 1-digit natural number divisors
 - multipliers and divisors that are multiples of 10
- Explaining and applying the order of operations, excluding exponents (limited to whole numbers).
- Developing and applying a formula for determining the
 - perimeter of polygons
 - area of rectangles
 - volume of right rectangular prisms

For more information on prior knowledge, refer to the following resource:

Manitoba Education and Advanced Learning. *Glance Across the Grades: Kindergarten to Grade 9 Mathematics*. Winnipeg, MB: Manitoba Education and Advanced Learning, 2015. Available online at www.edu.gov.mb.ca/k12/cur/math/glance_k-9/index.html.

BACKGROUND INFORMATION

Grade 7 provides an opportunity for students to review decimal concepts, to estimate, and to solve problems using operations with decimal numbers. In Grade 5, students added and subtracted decimals, and in Grade 6, they multiplied decimals by whole numbers and powers of 10 and divided decimals by whole numbers and powers of 10. In Grade 7, students extend multiplication and division to include decimal numbers with 2-digit multipliers and 1-digit divisors. They also explain mental mathematics strategies for multiplying and dividing by 0.1, 0.5, and 0.25.

For many practical situations involving decimals (e.g., calculating tips on restaurant bills, averaging numbers of points or people, purchasing goods sold by area or volume), estimated answers are often preferred over precise calculations. In other instances, such as when numbers are very large or very small, scientific notation is used.*

***Note:**

Scientific notation is no longer formally taught in the mathematics classroom.

Situations that involve many decimal points and require precise answers are often technical in nature, and technology is used to calculate these answers. Because estimates are common in everyday use, they provide an effective approach to teach operations with decimals.

The same principles that students have previously used with operations, estimations, models, and algorithms for whole numbers also apply to decimal numbers. When you choose learning activities, focus on number sense before addressing procedural operations. If students have difficulty with decimal operations, ensure that they have a good understanding of place value and that they understand the role of the decimal point. For example, certain statements (e.g., dividing by 100 means you move the decimal point two places to the left) can actually lead to misconceptions and emphasizes memorization of rules rather than understanding of concepts.

In learning activities that require estimating, provide students with opportunities to develop methods of determining where to position the decimal point in their estimates, and then have them attempt to calculate precise answers. As they work through this process, using their understanding of place value, expanded notation, and operations, they will develop a personal method or algorithm based on meanings. To be reliable, their algorithms must apply to all situations. Invite students to share, explain, and evaluate each other's methods. Then introduce traditional algorithms and explain their methodology and how these link to the students' personal methods. Avoid favouring one method over another; students should be free to select a method, providing it is mathematically sound and allows students to be efficient and accurate.

If students understand operations as actions (e.g., addition as a combining operation, subtraction as a taking away operation, multiplication as repeated addition or x groups of, and division as repeated subtraction, or partitioning a number into groups, or how many groups of x are in this number), they can represent the operations concretely or pictorially.

Manipulatives can be used to represent decimal numbers. Operations can be visually represented using number lines, place value mats, and/or grid paper (e.g., BLM 5–8.10: Base-Ten Grid Paper).

When representing decimals with base-10 blocks, it is necessary to establish which manipulatives represent the value of 1.

Example 1:

If a flat represents 1 unit,

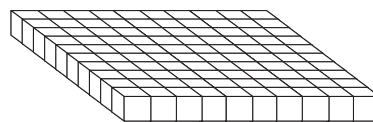

then a rod can represent $\frac{1}{10}$ or 0.1 unit,



and a cube can represent $\frac{1}{100}$ or 0.01 unit.



Example 2:

If a large block represents 1 unit,

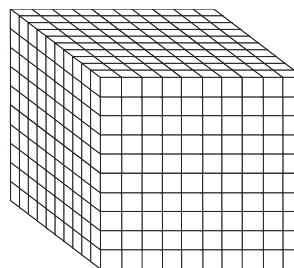

then a flat can represent $\frac{1}{10}$ or 0.1 unit,

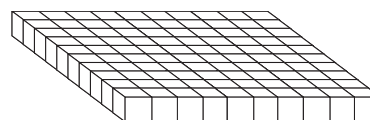

and a rod can represent $\frac{1}{100}$ or 0.01 unit,



and a cube can represent $\frac{1}{1000}$ or 0.001 unit.



For illustrations, refer to the Appendix at the end of this document.

MATHEMATICAL LANGUAGE

addend

addition

array

brackets

decimals

difference

dividend

division

divisor

estimation

exponents*

front-end estimation

hundredths

***Note:**

The term *exponent* may arise during discussion of the order of operations, but students are not required to know the term. Students will study exponents formally in Grade 9.

mental mathematics
multiplicand
multiplication
multiplier
order of operations
parentheses
product
quotient
subtraction
sum
tenths
thousandths

LEARNING EXPERIENCES



Assessing Prior Knowledge

Materials:

- list of mathematical terms
- paper for personal or class posters
- reference books

Organization: Individual or pairs

Procedure:

1. Have student create posters that illustrate the terms in the mathematical language list provided.

Observation Checklist

- Listen to and observe students' responses to determine whether students can do the following:
 - Illustrate and use mathematical terms correctly.



Assessing Prior Knowledge

Materials:

- BLM 5–8.17: Number Fans
- BLM 7.N.2.1: Whole and Decimal Number Cards
- BLM 7.N.2.2: Operation Cards
- brass tacks
- card stock (paper)
- display board (optional)

Organization: Whole class, a caller and a verifier (teacher or student)

Procedure:

1. Copy BLM 5–8.17: Number Fans onto card stock and attach two copies of each digit with a brass tack at the base of the fan.
2. Give each student a number fan.
3. Inform students that for this learning activity, either the teacher or students will take turns calling out whole and decimal numbers.
4. Ensure that the caller has access to BLM 7.N.2.1: Whole and Decimal Number Cards.
5. Inform students that they will proceed as follows:
 - a) The caller chooses a number from the list of cards, and says it slowly three times.
 - b) Players arrange the number using their respective number fans and hold it in front of their chests.
 - c) The verifier checks whether or not students' responses are correct.
 - d) Students perform some operation on their number using BLM 7.N.2.2: Operation Cards.
 - e) The verifier checks whether the responses are correct.

Variation:

- Form teams. Team members take turns writing numbers on the display board, or each team member records the numbers individually, and one team member is named to hold up the group's answer.

Observation Checklist

- Listen to and observe students' responses to determine whether students can do the following:
 - Represent decimal numbers to thousandths correctly.
 - Understand place value.
 - Use mental mathematics strategies.
 - Perform mathematical operations on decimal numbers.



Assessing Prior Knowledge

Materials:

- BLM 7.N.2.3: Equivalent Percent, Fraction, and Decimal Cards (sets of cards)

Organization: Small groups (two to five students)

Procedure:

1. The objective of this game is to create a set of four matching cards. A set consists of
 - a percent card
 - the decimal number expressed as tenths or hundredths
 - the decimal number expressed as thousandths
 - the number expressed as a fraction in lowest terms
2. Have students form small groups to play the game according to the general rules of Go Fish.
3. Students shuffle the cards, and deal five cards to each player in a group. They place the remaining cards face down in a pile.
4. One player asks another for a specific card. The asker must have at least one card of the set requested.
5. If the asked player has the card, he or she must give it to the asker.
6. If the asked player does not have the card, he or she says, "Go fish."
7. The asker then draws a card from the pile. If the asker is successful (picks up the card requested), he or she takes another turn. If not, play passes to the next player.

Variations:

- Use the cards to play Concentration. Arrange a number of matching cards face down. Players take turns turning over two cards to create sets. If the cards don't match, they are turned face down again.

Observation Checklist

- Listen to and observe students' responses to determine whether students can do the following:
 - Create sets of equivalent fractions, decimals, and percents.

Note:

This learning experience could be used within a body of evidence to report on the following competency on the Grade 7 Numeracy Assessment:

Student understands that a given number may be represented in a variety of ways.

Reference:

Manitoba Education and Advanced Learning. *Middle Years Assessment: Grade 7 Mathematics: Support Document for Teachers: English Program*. Winnipeg, MB: Manitoba Education and Advanced Learning, 2015. Available online at www.edu.gov.mb.ca/k12/assess/support/math7/.



Assessing Prior Knowledge

Materials:

- BLM 7.N.2.4: Order of Operations and Skill-Testing Questions (or similar questions)
- calculators

Organization: Individual or pairs, whole class

Procedure:

1. Review the order of operations with the class. Comment on how the order of operations is required in many skill-testing questions for contests (e.g., a draw at a store to win a bicycle or an electronic device).
2. Distribute copies of BLM 7.N.2.4: Order of Operations and Skill-Testing Questions, and have students answer the questions individually or in pairs.
3. After a set amount of time has passed, review responses as a class by having students share and justify their answers.
4. Have students respond to the questions using calculators to check whether or not their calculators are programmed to follow the order of operations.

Observation Checklist

- Listen to and observe students' responses to determine whether students can do the following:
 - Follow the order of operations.
 - Find solutions using mental mathematics strategies.

Suggestions for Instruction

- **Solve a problem involving the addition of two or more decimal numbers.**
- **Solve a problem involving the subtraction of decimal numbers.**
- **Place the decimal in a sum or difference using front-end estimation (e.g., for $4.5 + 0.73 + 256.458$, think $4 + 256$, so the sum is greater than 260).**
- **Check the reasonableness of answers using estimation.**

Materials:

- BLM 7.N.2.5: Money Problems
- BLM 7.N.2.6: Restaurant Bills and Biking
- BLM 5–8.16: Place-Value Mat–Decimal Numbers (optional)
- base-10 blocks (optional)

Organization: Individual or pairs, whole class

Procedure:

1. Distribute copies of BLM 7.N.2.5: Money Problems and/or BLM 7.N.2.6: Restaurant Bills and Biking.
2. Have students estimate answers before they do the calculations.
3. Students may model the addition and subtraction using BLM 5–8.16: Place-Value Mat–Decimal Numbers.
4. Circulate among students while they are working to assess their progress, and supply guidance if necessary. After students have had sufficient time to work on the problems, hold a debriefing discussion with the class, or collect and assess the completed papers.



Observation Checklist

- Listen to and observe students' responses to determine whether students can do the following:
 - Add decimal numbers correctly.
 - Subtract decimal numbers correctly.
 - Apply appropriate strategies to solve problems.

Suggestions for Instruction

- **Solve a problem involving the addition of two or more decimal numbers.**
- **Solve a problem involving the subtraction of decimal numbers.**
- **Solve a problem involving the multiplication or division of decimal numbers (for more than 1-digit divisors or 2-digit multipliers, technology could be used).**
- **Place the decimal in a sum or difference using front-end estimation (e.g., for $4.5 + 0.73 + 256.458$, think $4 + 256$, so the sum is greater than 260).**
- **Place the decimal in a product using front-end estimation (e.g., for $\$12.33 \times 2.4$, think $\$12 \times 2$, so the product is greater than $\$24$).**
- **Place the decimal in a quotient using front-end estimation (e.g., for $51.50 \text{ m} \div 2.1$, think $50 \text{ m} \div 2$, so the quotient is approximately 25 m).**
- **Check the reasonableness of answers using estimation.**

Materials:

- BLM 5–8.10: Base-Ten Grid Paper
- base-10 blocks
- coloured pencils
- math journals
- BLM 7.N.2.7: Sample Scenarios 1 (optional)

Organization: Individual, pairs, whole class

Procedure:

1. Present the class with scenarios that require multiplying by decimals, and ask students to estimate reasonable solutions. Samples are provided on BLM 7.N.2.7: Sample Scenarios 1. Exact solutions are not required at this point. These scenarios involve percent values that need to be converted to decimal numbers. Present one scenario at a time, or present several scenarios together as a set, depending on the needs of the class.
2. Ask students to record their estimates and the strategies they used to arrive at them.
3. Multiplication and division are inverse operations. Have students investigate the related division statements that match the scenarios. Compare the relations, and explore division strategies.

4. Begin with a brief Think-Pair-Share strategy to help students prepare for a whole-class discussion. Ask students to share their estimates, explain the strategies they used, justify where they placed the decimal, and explain why they think their solutions are reasonable. Possible responses may include
 - front-end estimation
 - rounding to the nearest whole
 - expanded notation

Encourage students to agree with, question, or challenge responses respectfully.

5. Following the discussion, have students return to the problems and calculate exact solutions, record the solutions in their math journals, and prepare to articulate the strategies they used and to explain why they think their solutions are correct. In a later learning experience, students will devise a method for multiplying by decimals, and apply it to other situations.



Observation Checklist

- Listen to and observe students' responses to determine whether students can do the following:
 - Create multiplication estimates with the decimal in the correct position.
 - Calculate exact solutions.
 - Solve a problem involving the multiplication of decimal numbers.
 - Place the decimal in a product using front-end estimation.
 - Check the reasonableness of answers using estimation.
 - Communicate mathematically.

Suggestions for Instruction

- **Solve a problem involving the multiplication or division of decimal numbers (for more than 1-digit divisors or 2-digit multipliers, technology could be used).**
- **Place the decimal in a product using front-end estimation (e.g., for $\$12.33 \times 2.4$, think $\$12 \times 2$, so the product is greater than $\$24$).**
- **Place the decimal in a quotient using front-end estimation (e.g., for $51.50 \text{ m} \div 2.1$, think $50 \text{ m} \div 2$, so the quotient is approximately 25 m).**
- **Check the reasonableness of answers using estimation.**

Materials:

- BLM 5–8.10: Base-Ten Grid Paper
- BLM 5–8.24: Number Line
- BLM 7.N.2.8: Sample Scenarios 2
- base-10 blocks
- coloured pencils
- math journals

Organization: Individual, pairs, whole class

Procedure:

1. Ask students to define *division* and to provide an illustration of the operation. Division may be understood as repeated subtraction, or partitioning into groups of a particular size or into a particular number of groups. Repeated subtraction can be shown on a number line, and partitioning can be shown with base-10 blocks. Division may be demonstrated by forming an array with base-10 blocks or drawing on base-10 grid paper (e.g., BLM 5–8.10: Base-Ten Grid Paper). For some examples, refer to the Appendix at the end of this document.
2. Present the class with scenarios requiring dividing by decimals, and ask students to estimate reasonable solutions. Samples are provided on BLM 7.N.2.8: Sample Scenarios 2. Present one scenario at a time, or present several scenarios together as a set, depending on the needs of the class.
3. Ask students to record their estimates and the strategies they used to arrive at them. Have students record their thinking.
4. Division and multiplication are inverse operations. Have students investigate the related multiplication statements that match the scenarios. Compare the relations and multiplication strategies.
5. Allow a few minutes for the use of a Think-Pair-Share strategy to help students prepare for a whole-class discussion in which they share their estimates and explain the strategies they used, how they decided where to place the decimal, and why they think the solutions are reasonable. Encourage students to agree with, question, or challenge responses respectfully. Record the reasonable estimates in a chart.

6. Following the discussion, have students return to the problems and calculate exact solutions, again recording their solutions in their math journals, and prepare to articulate the strategies they used and explain why they think their solutions are correct.



Observation Checklist

- Listen to and observe students' responses to determine whether students can do the following:
 - Create estimates for division with the decimal in the correct position.
 - Calculate exact solutions.
 - Solve a problem involving the division of decimal numbers.

Suggestions for Instruction

- **Solve a problem involving the multiplication or division of decimal numbers (for more than 1-digit divisors or 2-digit multipliers, technology could be used).**
- **Place the decimal in a product using front-end estimation (e.g., for $\$12.33 \times 2.4$, think $\$12 \times 2$, so the product is greater than $\$24$).**
- **Place the decimal in a quotient using front-end estimation (e.g., for $51.50 \text{ m} \div 2.1$, think $50 \text{ m} \div 2$, so the quotient is approximately 25 m).**
- **Check the reasonableness of answers using estimation.**

Materials:

- BLM 5–8.10: Base-Ten Grid Paper
- BLM 5–8.25: My Success with Mathematical Processes
- base-10 blocks
- coloured pencils or highlighters
- math journals
- calculators

Organization: Individual, pairs, whole class

Procedure:*Part A: Multiplying and Dividing by Powers of Ten*

1. Remind students that by applying their present knowledge of mathematics, they have successfully solved multiplication questions with 1- and 2-digit decimal multipliers, and have explored strategies for division involving decimal numbers.
2. Challenge students to articulate a method that will allow them to solve any such multiplication and division questions, and to share those methods with others.
3. Give students a set of multiplication questions that will help them to see an emerging pattern.

Examples:

0.5×10	0.6×10	0.7×10	0.8×10
0.5×1	0.6×1	0.7×1	0.8×1
0.5×0.1	0.6×0.1	0.7×0.1	0.8×0.1
0.5×0.01	0.6×0.01	0.7×0.01	0.8×0.01

4. Have students choose a few of the questions from above and vary the multiplier, the multiplicand, and both. Have them note anything interesting they discover.
5. Give students a set of division questions that will help them to see an emerging pattern.

Examples:

$0.5 \div 10$	$0.6 \div 10$	$0.7 \div 10$	$0.8 \div 10$
$0.5 \div 1$	$0.6 \div 1$	$0.7 \div 1$	$0.8 \div 1$
$0.5 \div 0.1$	$0.6 \div 0.1$	$0.7 \div 0.1$	$0.8 \div 0.1$
$0.5 \div 0.01$	$0.6 \div 0.01$	$0.7 \div 0.01$	$0.8 \div 0.01$

6. Have students choose a few of the questions from above and vary the divisor, the dividend, and both. Have them note anything interesting they discover.

Part B: Multiplying and Dividing Decimals

1. Remind students that by applying their present knowledge of mathematics, they have successfully solved multiplication questions with 1- and 2-digit decimal multipliers, and have explored strategies for division involving decimal numbers.
2. Challenge students to articulate a method that will allow them to solve any such multiplication and division questions, and to share those methods with others.

3. Give students a set of multiplication questions that will help them to see an emerging pattern.

Examples:

$$\begin{array}{cccc} 1.2 \times 3 & 12 \times 3 & 0.12 \times 3 & 0.12 \times 0.3 \\ 5.64 \times 2.5 & 56.4 \times 2.5 & 564 \times 2.5 & 5.64 \times 0.25 \end{array}$$

4. Have students create other sets of multiplication questions where the digits in the multiplier and multiplicand are the same, but the decimal shifts. Have them note anything interesting they discover.
5. Give students a set of division questions that will help them to see an emerging pattern.

Examples:

$$\begin{array}{cccc} 67.3 \div 4.8 & 6.73 \div 4.8 & 67.3 \div 0.48 & 0.673 \div 0.48 \\ 937.54 \div 2.56 & 9.3754 \div 25.6 & 9375.4 \div 256 & 93.754 \div 25.6 \end{array}$$

6. Have students create other sets of division questions where the digits in the divisor and dividend are the same, but the decimal shifts. Have them note anything interesting they discover.
7. Have students reflect on and record their success with mathematical processes, using BLM 5–8.25: My Success with Mathematical Processes.

Note:

When determining the placement of the decimal, it is important to explore a variety of methods, such as

- temporarily disregarding the decimal(s), using any previous algorithms to determine the digits in the solution, and then deciding where to place the decimal in the product based on estimation strategies
- removing the decimal(s) by multiplying by a power of 10, and, after finding the product, compensating by dividing by that power of 10
- using knowledge of place value and annexing zeros when multiplying and dividing by powers of 10, and noticing and applying generalizations (e.g., the number of digits to the right of the decimal point in the product is equal to the number of digits to the right of the decimal point in the factors)

It is imperative that students have ample exploration time to discover these generalizations without merely being told what they are. Remain open to hearing all discoveries students make and encourage students to discuss them.



Observation Checklist

- Listen to and observe students' responses to determine whether students can do the following:
 - Understand problem-solving strategies.
 - Apply appropriate problem-solving strategies.
 - Communicate ideas clearly.
 - Question ideas.
 - Describe an effective method for solving multiplication with decimal multipliers.
 - Describe an effective method for solving division questions with decimal multipliers.

Suggestions for Instruction

- **Solve a problem involving the multiplication or division of decimal numbers (for more than 1-digit divisors or 2-digit multipliers, technology could be used).**
- **Place the decimal in a product using front-end estimation (e.g., for $\$12.33 \times 2.4$, think $\$12 \times 2$, so the product is greater than $\$24$).**
- **Place the decimal in a quotient using front-end estimation (e.g., for $51.50 \text{ m} \div 2.1$, think $50 \text{ m} \div 2$, so the quotient is approximately 25 m).**
- **Check the reasonableness of answers using estimation.**

Materials:

- BLM 5-8.10: Base-Ten Grid Paper
- BLM 5-8.24: Number Line
- base-10 blocks
- coloured pencils
- calculators
- math journals

Organization: Individual, pairs, whole class

Procedure:

1. Ask students to define *division* and to provide an illustration of the operation. Division may be understood as repeated subtraction, or partitioning into groups of a particular size or into a particular number of groups. Repeated subtraction can be shown on a number line (see BLM 5–8.24: Number Line), and partitioning can be shown with base-10 blocks. Division may be demonstrated by forming an array with base-10 blocks or drawing on base-10 grid paper (see BLM 5–8.10: Base-Ten Grid Paper). Illustrations using base-10 blocks are outlined in the Appendix at the end of this document.
2. Ask students to illustrate the following division questions. After giving students sufficient time to consider the questions, ask them to discuss their definitions, illustrations, and discoveries.
 - a) $8 \div 4$
 - b) $8 \div 0.4$
 - c) $0.8 \div 0.4$
 - d) $0.8 \div 4$
3. Have students create other division questions and vary the place value position of the digits. They may use technology for divisors with two or more digits. Students record the equations in charts, and develop a personal method or algorithm for dividing with decimals. They prepare to discuss findings with the class.
4. Students may make the following observations or conclusions:
 - If the digits in the division questions remain the same, the digits in the quotients are the same. As with multiplication, the difference is in the place value position of the digits.
 - Students can use known division algorithms and either ignore the decimal place or find the digits in the solution, and then place the decimal according to their estimation.
 - They can rename the decimal numbers so they have the same place value (e.g., $4.0 \div 0.5$ is equivalent to 40 tenths divided by 5 tenths, which is 8).
 - They can use a balance scale principle and will get the same quotient if they multiply both numbers in the question by the same power of 10 (e.g., $4.5 \div 0.09$ is equivalent to multiplying both numbers by 100, which becomes $450 \div 9 = 50$).
5. Have students record in their math journals how to divide decimal numbers.
6. Ask students to write related multiplication statements for each of their division statements, and to compare the responses and procedures for dividing and multiplying decimal numbers.



Observation Checklist

- Listen to and observe students' responses to determine whether students can do the following:
 - Understand problem-solving strategies.
 - Apply appropriate problem-solving strategies.
 - Communicate ideas clearly.
 - Question ideas.
 - Describe an effective method for solving division with decimals.
 - Solve a problem involving the division of decimal numbers.
 - Place the decimal in a quotient using front-end estimation.
 - Check the reasonableness of answers using estimation.

Suggestions for Instruction

- **Solve a problem involving the multiplication or division of decimal numbers (for more than 1-digit divisors or 2-digit multipliers, technology could be used).**
- **Place the decimal in a product using front-end estimation (e.g., for $\$12.33 \times 2.4$, think $\$12 \times 2$, so the product is greater than $\$24$).**
- **Place the decimal in a quotient using front-end estimation (e.g., for $51.50 \text{ m} \div 2.1$, think $50 \text{ m} \div 2$, so the quotient is approximately 25 m).**
- **Check the reasonableness of answers using estimation.**

Materials:

- BLM 7.N.2.9: Sample Scenarios 3

Organization: Individual

Procedure:

1. When students have a method for solving multiplication problems with decimal numbers, give them opportunities to solve a variety of problems, such as those provided on BLM 7.N.2.9: Sample Scenarios 3.
2. Remind students that estimating answers before calculating solutions is important to verify that answers are reasonable. This strategy is important when using technology.



Observation Checklist

- Listen to and observe students' responses to determine whether students can do the following:
 - Place decimal points in the correct position.
 - Solve problems correctly.
 - Solve a problem involving the multiplication or division of decimal numbers.
 - Place the decimal in a product using front-end estimation.
 - Place the decimal in a quotient using front-end estimation.
 - Check the reasonableness of answers using estimation.

Suggestions for Instruction

- **Solve a problem involving the multiplication or division of decimal numbers (for more than 1-digit divisors or 2-digit multipliers, technology could be used).**
- **Place the decimal in a quotient using front-end estimation (e.g., for $51.50 \text{ m} \div 2.1$, think $50 \text{ m} \div 2$, so the quotient is approximately 25 m).**
- **Check the reasonableness of answers using estimation.**
- **Solve a problem that involves operations on decimals (limited to thousandths), taking into consideration the order of operations.**

Materials:

- BLM 7.N.2.10: Decimal Problems
- index cards (optional)

Organization: Individual

Procedure:

1. Students solve division and order of operation questions such as those found on BLM 7.N.2.10: Decimal Problems.

Variation:

- Have students create their own scenarios and solutions on index cards. Students can exchange their scenarios and solutions with a classmate, or add them to a question bank to use as Exit Slips or for in-class challenges.



Observation Checklist

- Listen to and observe students' responses to determine whether students can do the following:
 - Place the decimal correctly while estimating.
 - Use the order of operations to answer multi-step problems correctly.
 - Solve a problem involving the multiplication or division of decimal numbers.
 - Place the decimal in a quotient using front-end estimation.
 - Check the reasonableness of answers using estimation.
 - Solve a problem that involves operations on decimals, taking into consideration the order of operations.

Suggestions for Instruction

- **Explain, using an example, how to use mental mathematics for products or quotients when the multiplier or the divisor is 0.1 or 0.5 or 0.25.**

Materials:

- BLM 5-8.10: Base-Ten Grid Paper
- base-10 blocks
- math journals

Organization: Pairs or small groups, whole class, individual

Procedure:

1. Present students with a mission: Discover a quick mental mathematics strategy to use when multiplying any number by 0.1. Later, the problem will be extended to finding the quotient for dividing by 0.1, and then to finding products and quotients for multiplying and dividing by 0.5 and 0.25.
2. If students need guidance to organize their investigation, assist them with the following hints. Encourage them to use a problem-solving strategy, rather than follow a set of steps.

Example:

What must you do? What must you know in order to do what you have determined you need to do? How can you get that information? What does it mean to multiply? What does it mean to multiply by 0.1? What is 0.1? What do you need in order to find a pattern?

- a) First, ensure that students understand the problem and can articulate the meaning of multiplication by 0.1.
 - b) Next, have them explore the patterns created by multiplying a set of numbers by 0.1.
 - c) Finally, have them examine the patterns they see, and create a mental mathematics strategy to find the product when multiplying by 0.1. Test the strategy to ensure it works for all numbers. Try numbers such as 120 or 122, or smaller numbers such as 0.1×0.5 or 0.1×0.01 .
3. After students (working in pairs or in small groups) have had sufficient time to explore and develop a strategy, have them reassemble as a class to debrief, giving them an opportunity to communicate their ideas and questions and revise their strategies as necessary. Then have them use their math journals to record their strategies and explain why the strategies work.
 4. Extend the problem to finding the quotient for dividing by 0.1, and then products and quotients for multiplying and dividing by 0.5 and 0.25.



Observation Checklist

- Listen to and observe students' responses to determine whether students can do the following:
 - Use a mathematically correct mental mathematics strategy for each operation.
 - Provide an explanation that supports the strategy.
 - Use effective problem-solving strategies.
 - Explain, using an example, how to use mental mathematics for products or quotients when the multiplier or the divisor is 0.1 or 0.25.

PUTTING THE PIECES TOGETHER

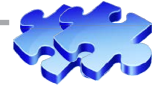

School-Supply Kits

Introduction:

Students receive a budget for creating 20 school-supply kits to be given as welcome gifts to new students in need.

Purpose:

In this investigation, students will demonstrate the ability to do the following (connections to learning outcomes are identified in parentheses):

- Perform operations with decimals to solve problems. (7.N.2)
- Solve problems involving percents from 1% to 100%. (7.N.3)
- Compare and order decimals and integers. (7.N.7)

Students will also demonstrate the following mathematical processes:

- Communication
- Connections
- Mental Mathematics and Estimation
- Problem Solving
- Reasoning
- Technology

Materials/Resources:

- office- and school-supply flyers and print and online catalogues, and/or access to office and school-supply stores
- calculators
- shopping list
- purchase order

Organization: Individual or small group

Procedure:

Student Directions

1. Several new students have been arriving at your school without any school supplies or any means to obtain them. This has added to the students' difficulties in trying to adjust to their new school experience. The student council has held a fundraising drive to help future new students adjust to their new school experience. They have raised \$500 to create 20 school-supply kits. In the future, a kit will be given as a welcome gift to a new student in need. The student council has chosen your group to prepare the kits.

2. Create a list of school-supply items and quantities required for each kit.
3. Calculate the total number of each item required for all the kits.
4. Shop to find prices for the items. Use estimations to help guide your choices. Remember to add PST and GST and any applicable shipping or handling costs. Stay as close to budget as possible.
5. Prepare a clearly written letter to inform the store of your project and request their assistance. You receive a response to your letter from the store offering a 25% discount to help with your project.
6. Make any desired adjustments to your shopping list.
7. Finalize the items to purchase. Remember that PST and GST will be added and shipping or handling charges may be added. Stay as close to budget as possible.
8. Prepare a purchase order for the store. List the items from least expensive to most expensive, the quantities to order, unit price, extended price, discounted or adjusted price, subtotal, taxes, shipping and handling charges (if applicable), and the grand total.
9. Prepare a clearly written letter to the student council regarding your decision. Include a list of the items to be included in each school-supply kit, identify any extra items that will be left over, compare the cost to the budget, and include the purchase order.



Observation Checklist

- Listen to and observe students' responses to determine whether students can do the following:
 - Create an adequate list of school supplies to include in each kit.
 - Make reasonable estimates to guide decision making.
 - Perform operations with decimal numbers correctly.
 - Calculate percents accurately (discount, GST, PST).
 - Make decisions to match a budget within 5%.
 - Order and calculate the purchase order correctly.
 - Prepare a clear letter requesting assistance.
 - Prepare a clear summary letter outlining actions and comparing cost to budget.

Shopping List for School-Supply Kits

Item	Quantity Required for Each Kit	Quantity for 20 Kits	Purchase Price	Cost Per Item	Cost Per 20 Kits

Purchase Order for School-Supply Kits

To:

From:

Item Description	Quantity Required	Unit Price	Extended Price	Adjusted Price
Subtotal				
GST (5%)				
PST (7%)				
Shipping and Handling Charges				
Grand Total				

Number (7.N.3)

Enduring Understanding(s):

Percents can be thought of as a ratio comparing to 100 or a fraction out of 100.

Circle graphs show a comparison of each part to a whole using ratios.

Percents, fractions, decimals, and ratios are different representations of the same quantity.

Number sense and mental mathematics strategies are used to estimate answers and lead to flexible thinking.

General Learning Outcome(s):

Develop number sense.

SPECIFIC LEARNING OUTCOME(S):	ACHIEVEMENT INDICATORS:
7.N.3 Solve problems involving percents from 1% to 100%. [C, CN, ME, PS, R, T]	→ Express a percent as a decimal or fraction. → Solve a problem that involves finding a percent. → Determine the answer to a percent problem where the answer requires rounding, and explain why an approximate answer is needed (e.g., total cost including taxes).

PRIOR KNOWLEDGE

Students may have had experience with the following:

- Applying estimation strategies, including
 - front-end rounding
 - compensation
 - compatible numbersin problem-solving contexts.
- Applying mental mathematics strategies for multiplication, such as
 - annexing, then adding zeros
 - halving and doubling
 - using the distributive property

- Demonstrating an understanding of fractions by using concrete and pictorial representations to
 - create sets of equivalent fractions
 - compare fractions with like and unlike denominators
- Describing and representing decimals (tenths, hundredths, thousandths) concretely, pictorially, and symbolically.
- Relating decimals to fractions (tenths, hundredths, thousandths).
- Comparing and ordering decimals (tenths, hundredths, thousandths) by using
 - benchmarks
 - place value
 - equivalent decimals
- Demonstrating an understanding of place value for numbers
 - greater than one million
 - less than one-thousandth
- Demonstrating an understanding of factors and multiples by
 - determining multiples and factors of numbers less than 100
 - identifying prime and composite numbers
 - solving problems involving factors or multiples
- Demonstrating an understanding of ratio, concretely, pictorially, and symbolically.
- Demonstrating an understanding of percent (limited to whole numbers) concretely, pictorially, and symbolically.

For more information on prior knowledge, refer to the following resource:

Manitoba Education and Advanced Learning. *Glance Across the Grades: Kindergarten to Grade 9 Mathematics*. Winnipeg, MB: Manitoba Education and Advanced Learning, 2015. Available online at www.edu.gov.mb.ca/k12/cur/math/glance_k-9/index.html.

RELATED KNOWLEDGE

Students should be introduced to the following:

- Demonstrating an understanding of the addition, subtraction, multiplication, and division of decimals to solve problems (for more than 1-digit divisors or 2-digit multipliers, technology could be used).
- Demonstrating an understanding of the relationship between repeating decimals and fractions, and terminating decimals and fractions.

BACKGROUND INFORMATION

People regularly encounter practical situations requiring them to understand and solve problems related to percent. These situations include problems related to sports statistics, discounts, price increases, taxes, polls, social changes and trends, the likelihood of precipitation, and so on. The media provide sources of contextual data for creating problems involving percent.

Learning outcome 7.N.3 builds on understandings related to fractions, ratios, decimals, percents, and problem solving that students have developed in previous grades.

Fractions and Decimals

Before students become skilful at solving problems involving percent, they must have a strong conceptual understanding of fractions, decimals, and percents, and they must be able to interchange equivalent names to represent the concepts.

The term *fraction* has several meanings. An expert blends and separates these meanings for convenience, but this blending can confuse students who lack fluency in applying the different meanings of fraction. *Fraction notation* is used to represent a “cut” or a part of a unit, a part of a group or set, a measurement, or a point on a number line. It is also used to represent a ratio or a portion of a turn, and to indicate the division operation.

Decimals are a convenient means of representing fractional quantities using a place value system. Fractions may be converted to decimals by using the division operation meaning of fraction and dividing the numerator by the denominator (e.g., $\frac{3}{4}$ may be viewed as $3 \div 4 = 0.75$). Fractions may also be converted to decimals by finding an equivalent fraction with a denominator of any power of 10 (e.g., 100), and then writing the fraction in standard notation (e.g., $\frac{7}{50} = \frac{14}{100} = 0.14$). It is useful to commit to memory some common fraction decimal equivalents, such as halves, quarters, and tenths.

A *decimal point* is used to separate whole units from parts of units. Each position to the right of the decimal represents a tenth part of one of the previous units. In standard notation, the first position following the decimal represents tenth parts of one whole unit, and the second place represents tenth parts of a tenth, or hundredth parts of one unit.

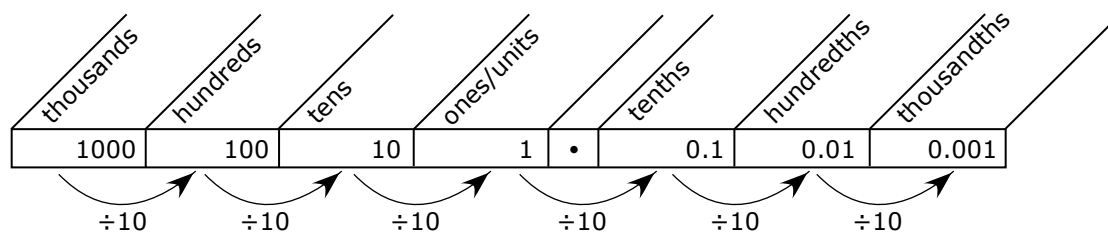

Problems Involving Percent

When translating standard notation to percent, the decimal point indicates where to read the hundredths in a number. The word *percent* means per hundred and may be substituted for the word *hundredths* when reading a number. Therefore, $\frac{7}{100}$ or 0.07 may be read as 7 hundredths and also as 7 percent.

Percent may also be used to represent fractional quantities that are a little larger than a hundredth. Place value positions to the right of the decimal represent the “cut” meaning of a fraction, and each successive position represents one of the previous units cut into 10. In standard notation, the third position represents thousandth parts of one unit, but it may also be viewed as tenths of a hundredth.

An understanding of place value allows us to express any number as a number of selected units. Just as 141 can represent 14 tens and 1 one, 0.141, which represents a number that is a little larger than one tenth of one whole, may be expressed as 1.41 tenths, 14.1 hundredths, or 141 thousandths. Substituting the word *percent* as another word for *hundredth*, the decimal number 0.141 may be considered as 14.1 hundredths, or 14.1 percent (%).

In Grade 7, students need to work only with numbers from 1% to 100%. The percents may represent a part of one whole item or a part of one whole group. Percent represents a special type of fraction with a denominator of 100. The quantity represented by the percent depends on the amount in the whole. For example, 1% may be a large or small quantity, depending on the whole. Consider 1% of the money in an individual’s piggy bank, versus 1% of the money in the bank’s books. The same quantity may also represent different percent values. For example, 20 is 20% of 100, but it is also 100% of 20. Identifying which number in a situation represents the whole and which number represents the part is important when solving problems involving percent.

When students have developed multiple views of fractions and percents, they will benefit from having multiple meaningful approaches to find percent values.

- To find 25% of 80, students may approach the problem as follows:
 - Think of 25% as $\frac{25}{100}$, and the equivalent fraction $\frac{1}{4}$, and then find $\frac{1}{4}$ of 80 by dividing 80 into 4 groups: $80 \div 4 = 20$, so 25% of 80 is 20.
 - Think of an equivalent fraction $\frac{25}{100} = \frac{1}{4} = \frac{\quad}{80}$. This view is less convenient in this situation, but more convenient in other situations.
 - Think of a part-to-whole ratio and proportion: $\frac{25}{100} = \frac{\quad}{80}$.
 - Think of a circle with beginning and end points 0 and 80, and think of 25% as $\frac{1}{4}$ of a turn.

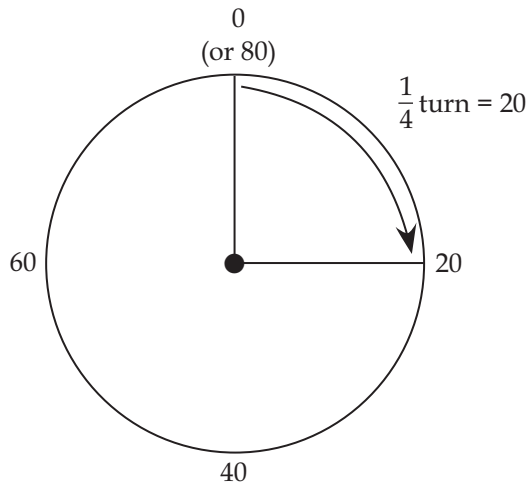

- Think of a circle graph that shows 25% of the students in a class like Caesar salad and 75% like taco salad. If there are 80 students in the class, how many like Caesar salad?

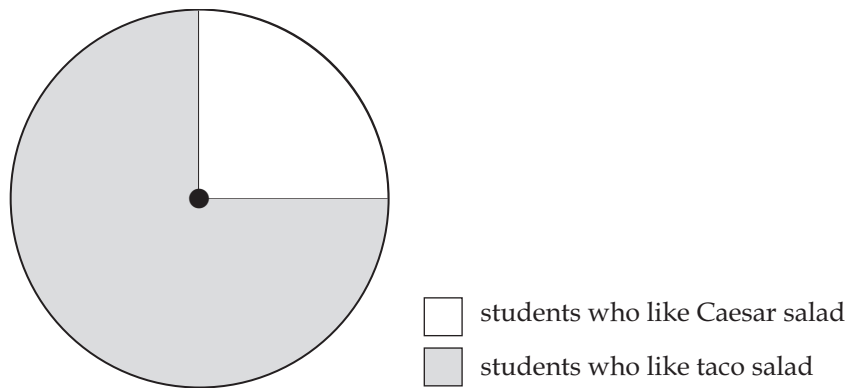

- Think of a number line with end points of 0 and 80, and corresponding points 0% and 100%. Students may think 25% is half of 50%. Half of 80 is 40, and half of 40 is 20.

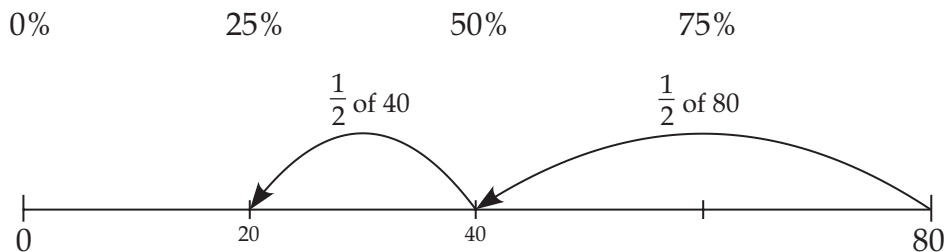

- Think of the decimal equivalent, and change the word expression into a number expression.

25% of 80 is _____

$0.25 \times 80 =$ _____

- Students may also use mental mathematics and the distributive property to solve problems involving percent.
 - To find 35% of 80, think of 35% as 25% + 10%.
 - In the above problem, 25% of 80 is 20, and 10% of 80 is 8.

$$20 + 8 = 28, \text{ so } 35\% \text{ of } 80 \text{ is } 28.$$
- Students may also use related fractions to solve percent problems.
 - If $\frac{1}{4}$ of 80 is 20, then $\frac{3}{4}$ of 80 must be 3×20 or 60.

With multiple approaches to finding percents, students can choose the most convenient approach for each problem.

When setting up examples and creating problems for students, frequently choose numbers that are convenient to work with, so that students will be able to concentrate on the processes involved, rather than on the arithmetic.

Also encourage students to use a variety of approaches and not to over-rely on one specific method. For example, they may develop a habit of using factors of 10, and forget to use equivalent fractions or the commonly used, very effective part-to-whole ratio approach. To find 25% of a number, you may think 25% is 10% + 10% + half of 10%, but it may be much more convenient to think of 25% as $\frac{1}{4}$, and divide the whole by 4.

MATHEMATICAL LANGUAGE

decimal
 equivalent
 factor
 fraction
 multiple
 percent
 proportion
 ratio
 simplify



Assessing Prior Knowledge

Materials:

- markers or pens of two different colours (for each pair of students)
- two regular number cubes (providing factors 1 to 12) or a multi-sided cube
- grid paper or tic-tac-toe grids or frames (of various sizes), such as the following:
 - BLM 7.N.3.1A: Tic-Tac-Toe Frames
 - BLM 7.N.3.1B: Tic-Tac-Toe Frames (Medium Challenge)
 - BLM 7.N.3.1C: Tic-Tac-Toe Frame (Ultimate Challenge)

Organization: Pairs

Procedure:

1. Have pairs of students take turns filling in the squares of their tic-tac-toe grids with numbers 1 to 99, or multiples that correspond to the numbers on their number cubes.
2. Students choose a colour and an X or an O mark, and determine who will play first.
3. Students take turns rolling the number cube(s), and use their colour markers to mark an X or an O on a multiple of the number they rolled. Encourage them to practise using mathematical language with statements such as the following:
 - 27 is a multiple of 9 because $3 \times 9 = 27$.
 - 9 and 3 are factors of 27 because $3 \times 9 = 27$.
 - 17 is a prime number. Its only factors are 1 and 17.
4. Students will need to agree about what to do if someone makes an error.
5. The first student who creates a horizontal, vertical, or diagonal line with his or her marks wins.

Observation Checklist

- Listen to and observe students' responses to determine whether students can do the following:
 - Use vocabulary for multiples, factors, and primes correctly.
 - Identify multiples of various numbers correctly.
 - Identify prime numbers correctly.



Assessing Prior Knowledge

Materials:

- BLM 7.N.3.2: Equivalent Fraction Challenge
- a pair of six-sided number cubes, or a multi-sided number cube, or a spinner (for each pair of students)

Organization: Whole class, pairs

Procedure:

1. As a class, review procedures for creating equivalent fractions by multiplying or dividing by a fraction name for 1, or by multiplying or dividing each term in the fraction by the same factor.
2. Demonstrate one round of the game, following the procedures outlined on BLM 7.N.3.2: Equivalent Fraction Challenge, and using the game cards provided on the BLM. In summary, students create a target fraction, take turns rolling the number cube(s) to determine a change factor, and then create an equivalent fraction. The player who returns the fraction to its original target name wins.
3. Distribute game cards.
4. Have students play the game in pairs.

Observation Checklist

- Listen to and observe students' responses to determine whether students can do the following:
 - Create equivalent fractions correctly and simplify fractions with ease.



Assessing Prior Knowledge

Materials:

- BLM 7.N.3.3: It's Between: Rounding Decimal Numbers
- demonstration board

Organization: Individual, or pairs, or whole class

Procedure:

1. Review the place value positions for decimal numbers, and review how to read and write decimal numbers.
2. Review strategies for rounding decimal numbers to a given place value position by identifying which numbers the given number is between and then determining which number it is closest to.
Example: Round 0.6521 to the nearest tenth.
3. Identify the value of the required place value. In the above example, it is tenths (0.652 has 6 tenths and a little more).
4. Identify one unit higher for the same place value. One unit higher than 6 tenths is 7 tenths (0.652 is between 6 tenths and 7 tenths).
5. Determine whether 0.652 is closer to 6 tenths or to 7 tenths by thinking of the numbers on a line, with the midway point between the numbers being 0.65. Since 0.652 is a little more than 0.65, it is closer to 0.7 than it is to 0.6. So, 0.652 rounded to the nearest tenth is 0.7.

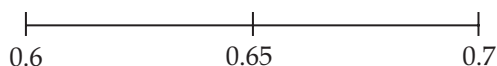

6. Repeat the same process for rounding to the nearest hundredth, and then to the nearest thousandth.
7. Have students verify their skill by rounding a set of numbers such as those provided on BLM 7.N.3.3: It's Between: Rounding Decimal Numbers.

Variation:

- Using the demonstration board, present one question at a time and have students solve it. Call upon one student to identify the numbers between which a given number lies, and another student to identify which number it is closest to, and therefore rounds to.

Observation Checklist

- Listen to and observe students' responses to determine whether students can do the following:
 - Identify place values correctly.
 - Determine the numbers between which the number being rounded lies.
 - Round a number to the required decimal place correctly.

Suggestions for Instruction

- **Express a percent as a decimal or fraction.**
- **Determine the answer to a percent problem where the answer requires rounding, and explain why an approximate answer is needed (e.g., total cost including taxes).**

Materials:

- BLM 7.N.3.4: Choose Your Question (Point Sheet, Game Sheet 1 and Game Sheet 1 Answer Key, Blank Game Sheet)
- scissors
- low-tack glue
- corrugated board
- pins, tacks, or staples

Organization: Whole class, small groups (three to five students)

Procedure:

1. Review the place value positions for decimal numbers, and review reading and writing decimal numbers.
2. Review strategies for rounding decimal numbers to a given place value position, as described in the preceding learning activity.
3. Review reading decimal numbers as percents, as outlined in the Background Information for learning outcome 7.N.3 (e.g., 0.456 may be read as 45.6%).

4. Play the game outlined in BLM 7.N.3.4: Choose Your Question, using the following procedure:
- a) Form student groups, each containing one quizmaster and three to five contestants.
 - b) Distribute copies of BLM 7.N.3.4: Choose Your Question (Point Sheet, Game Sheet 1 and Answer Key, Blank Game Sheet), along with other required materials, and have student groups make game boards.
 - The contestants receive the category Point Sheet and cut up the sections, which they give to the quizmaster.
 - The quizmaster receives the Game Sheet and Answer Key. He or she hides the Answer Key, and uses the Game Sheet to create a game board by tacking the Point Sheet sections over the questions with temporary low-tack glue, or by placing the Game Sheet on the corrugated board and tacking the point cards in place with pins, tacks, or staples.
 - c) Students decide which contestant will go first.
 - d) That contestant chooses a category and point value.
 - e) The quizmaster uncovers the question. If the contestant responds correctly, he or she receives the point card.
 - f) Play then moves to the next contestant. The player with the most points at the end wins. The winner becomes the quizmaster for additional rounds. A Blank Game Sheet is included for additional rounds.

Variation:

- Alter the categories to include any skills you wish to review (Game Sheet 2 includes part-to-whole ratios and percents as decimals and fractions).



Observation Checklist

- Listen to and observe students' responses to determine whether students can do the following:
 - Round decimal numbers to the designated place value correctly.
 - Express a decimal number as a percent.

Suggestions for Instruction

- **Express a percent as a decimal or fraction.**

Materials:

- BLM 7.N.3.4: Choose Your Question (Point Sheet, Game Sheet 2, Blank Game Sheet) (optional)
- scissors

Organization: Small groups (three to five students)

Procedure:

1. Review expressing a situation as a part-to-whole ratio, and vice versa.
2. Review expressing a percent as a decimal number, and vice versa (include percents such as $5\frac{3}{4}\%$ or $2\frac{1}{2}\%$), which are common in interest rates or pay-increase rates).
3. Review expressing a percent as a decimal and as a fraction, and vice versa.
4. Follow the directions for Game Sheet 1 in the previous learning activity.

Note:

This learning experience could be used within a body of evidence to report on the following competency on the Grade 7 Numeracy Assessment:

Student understands that a given number may be represented in a variety of ways.

Reference:

Manitoba Education and Advanced Learning. *Middle Years Assessment: Grade 7 Mathematics: Support Document for Teachers: English Program*. Winnipeg, MB: Manitoba Education and Advanced Learning, 2015. Available online at www.edu.gov.mb.ca/k12/assess/support/math7/.



Observation Checklist

- Listen to and observe students' responses to determine whether students can do the following:
 - Express situations as ratios and percents correctly.
 - Express a percent as a decimal correctly.
 - Express a percent as a fraction correctly.
 - Express a fraction as a percent correctly

Suggestions for Instruction

- **Express a percent as a decimal or fraction.**

Materials:

- various card sets for each group from the following website:
Manitoba Education. "Middle Years Activities and Games." *Mathematics*.
www.edu.gov.mb.ca/k12/cur/math/my_games/index.html
- BLM 7.N.2.3: Equivalent Percent, Fraction, and Decimal Cards

Organization: Small groups (three or four students)

Procedure:

1. Have students use decks of cards created from BLM 7.N.2.3: Equivalent Percent, Fraction, and Decimal Cards. Tell students they will play a game according to the rules of Rummy. The objective of the game is to create sets of four matching cards (a percent, a fraction, a decimal, and an illustration) and to be the first person to dispose of all his or her cards.
2. Have students form small groups and choose a dealer. The dealer shuffles the cards and deals seven cards to each player, who then secretly sorts them into sets. The dealer places the remaining cards face down on the table to form a draw pile, and turns the top card of the draw pile face up to form a discard pile.
3. The first player begins by drawing a card from either the draw pile or the discard pile. The player may lay any sets of three or four equivalent cards face up on the table in front of him or her. In the same turn, the player may also play equivalent cards on top of other players' equivalent sets. The player completes a turn by playing a card on the discard pile. This card may not be the same card the player selected from the discard pile at the beginning of the turn.
4. Play passes to the next player.
5. The round is over when the first player discards his or last card on the discard pile.

Note:

This learning experience could be used within a body of evidence to report on the following competency on the Grade 7 Numeracy Assessment:

Student understands that a given number may be represented in a variety of ways.

Reference:

Manitoba Education and Advanced Learning. *Middle Years Assessment: Grade 7 Mathematics: Support Document for Teachers: English Program*. Winnipeg, MB: Manitoba Education and Advanced Learning, 2015. Available online at www.edu.gov.mb.ca/k12/assess/support/math7/.

Variations:

- Use the cards to play Go Fish, using rules outlined in the suggested learning experiences for learning outcome 7.N.2 for fraction, decimal, and percent equivalents.



Observation Checklist

- Listen to and observe students' responses to determine whether students can do the following:
 - Express a percent as a decimal or fraction correctly.

Suggestions for Instruction

- **Express a percent as a decimal or fraction.**

Materials:

- BLM 7.N.3.5: Designing to Percent Specifications
- coloured pencils or markers

Organization: Individual

Procedure:

1. Create a design on 100-grid paper that meets set percent specifications. Grid paper is provided on BLM 7.N.3.5: Designing to Percent Specifications.
2. Express each percent as a decimal and as a fraction.
3. Simplify the fractions.

Example:

10% of the design is red.

40% of the design is blue.

15% of the design is green.

The remainder of the design is yellow.



Observation Checklist

- Listen to and observe students' responses to determine whether students can do the following:
 - Express a percent as a decimal or fraction correctly.

Suggestions for Instruction

- **Express a percent as a decimal or fraction.**
- **Solve a problem that involves finding a percent.**

Materials:

- BLM 7.N.3.6: Determining the Whole, the Part, and the Percent
- math journals
- demonstration board
- marking pen

Organization: Whole class

Procedure:

Part A

1. Inform students that percents are a special type of fractions out of 100. Therefore, each percent problem is a part-to-whole relation and may be represented as a fraction problem.
2. Present situations that involve finding the whole, the part, and the percent. Present one situation at a time, recording it on the board.
3. For each situation presented, ask students to identify the whole, the part, and the percent, either on BLM 7.N.3.6: Determining the Whole, the Part, and the Percent or in their math journals, and then highlight what they are to find. Next, they write a word phrase or a number expression to represent the situation. Students do not find the solutions at this time. The problem will be solved in the next step.
4. Ask a student to share his or her response and record it on the board. Encourage students to confirm or question the response. During this discussion time, address any questions students have, and correct any errors with a marking pen.
5. Continue with the next situation, until sufficient examples have been explored. Include several examples of each of the following three types of situations students will encounter in solving problems with percent:
 - A designated percent of a designated number is what number?

Example:

There are 80 cars in a shipment, and 40% of them are silver. How many are silver?

40% of 80 is ____.

- A designated number is what percent of another designated number?

Example:

There are 60 cars in a shipment, and 15 of them are red. What percent are red?

15 is ___% of 60.

- A designated number is a designated percent of what number?

Example:

25% of the cars in a shipment are blue. There are 50 blue cars. How many cars are in the shipment?

50 is 25% of ___.

Part B

1. Return to the first situation presented, and ask students to find the solution.
2. After students have had sufficient time to find the solution, ask individual students to share their response and describe the strategy they used to find the solution. In the class discussion, encourage students to confirm or question the shared responses, and to suggest alternative strategies. Address any questions students have, and correct any errors with a marking pen.
3. Solve all the situations in this manner.



Observation Checklist

- Listen to and observe students' responses to determine whether students can do the following:
 - Express a percent as a decimal or fraction.
 - Solve a problem that involves finding a percent.

Suggestions for Instruction

- **Express a percent as a decimal or fraction.**
- **Solve a problem that involves finding a percent.**

Materials:

- BLM 7.N.3.7: Finding the Missing Numbers in the Percent (Scenarios)

Organization: Individuals, small groups or whole class (for sharing responses)

Procedure:

1. Distribute copies of BLM 7.N.3.7: Finding the Missing Numbers in the Percent (Scenarios).
2. Ask students to complete three of the percent problems presented on the BLM, one problem requiring them to find the whole, one to find the part, and one to find the percent. Remind students to identify the whole, the part, and the percent of each problem, before attempting a solution (as they did in the previous learning activity). They may find it helpful to create an expression to summarize the problem. Having them show two strategies to solve each problem will help them stay flexible in their problem-solving strategies.
3. When students have had sufficient time for their individual work, have them meet in small groups or as a whole class to share their strategies and answers. Have students discuss their preferred strategy for each problem.

**Observation Checklist**

- Listen to and observe students' responses to determine whether students can do the following:
 - Express a percent as a decimal or fraction.
 - Solve a problem that involves finding a percent.

Suggestions for Instruction

- **Determine the answer to a percent problem where the answer requires rounding, and explain why an approximate answer is needed (e.g., total cost including taxes).**

Materials:

- BLM 7.N.3.8: Percent Problems
- demonstration board
- math journals or notebooks
- marking pens

Organization: Whole class (for demonstrations), individual or small groups (for practice)

Procedure:

1. Explain to students that some problems contain situations that require the solution to be rounded for practical reasons.

2. Review decimal, fraction, and percent equivalents with a quick oral quiz or a contest (e.g., a spelling bee), with teams lined up perpendicular to the board. Each team sends a representative to the board. The representative writes the decimal, fraction, or percent equivalents on the board. If the response is correct, the player returns to the end of the line; if the response is incorrect, the player steps out of the line and watches. The last team with a player at the board wins.
3. Present the class with a problem, which may or may not require rounding.

Example:

Your grandmother is going to buy a hooded sweatshirt for your birthday. She heads down to the Pretty Trendy Clothing Store, and finds that the store has an anniversary special. All regular prices are reduced by 20%. She selects a sweatshirt that is regularly priced at \$59.99 and pays GST of 5%. How much does she pay for the sweatshirt?

4. Ask students to solve the problem in their math journals or notebooks.
5. After students have had sufficient time to work on the problem, ask individuals to share the strategies they used to solve the problem. Compare students' solutions, noting whether or not students used rounding, and discuss reasons for their decisions. Discuss which strategies students prefer for this problem. Ensure that students consider the option of calculating the remaining cost versus calculating the value of the sale and subtracting it from the original price (80% of \$59.99 versus \$59.99 - 20% of \$59.99). During the discussion, have students make changes or add comments to their work with a marking pen. They may make a math journal entry suggesting hints for solving problems with percents.
6. Follow the same procedure for a few more problems such as the ones listed on BLM 7.N.3.8: Percent Problems.

Variation:

- After presenting situations requiring rounding and providing a few examples, have students create their own problems and solution keys. Then have students exchange problems with group members, solve the problems, and later reassemble as a group to discuss solutions.



Observation Checklist

- Listen to and observe students' responses to determine whether students can do the following:
 - Express a percent as a decimal or fraction.
 - Solve a problem that involves finding a percent.
 - Determine the answer to a percent problem where the answer requires rounding, and explain why an approximate answer is needed.

Number (7.N.4)

Enduring Understanding(s):

Percents, fractions, decimals, and ratios are different representations of the same quantity.

Number sense and mental mathematics strategies are used to estimate answers and lead to flexible thinking.

Circle graphs show a comparison of each part to a whole using ratios.

General Learning Outcome(s):

Develop number sense.

SPECIFIC LEARNING OUTCOME(S):	ACHIEVEMENT INDICATORS:
<p>7.N.4 Demonstrate an understanding of the relationship between repeating decimals and fractions, and terminating decimals and fractions. [C, CN, R, T]</p>	<ul style="list-style-type: none">→ Predict the decimal representation of a fraction using patterns (e.g., $\frac{1}{11} = 0.\overline{09}$, $\frac{2}{11} = 0.\overline{18}$, $\frac{3}{11} = ? \dots$).→ Match a set of fractions to their decimal representations.→ Sort a set of fractions as repeating or terminating decimals.→ Express a fraction as a terminating or repeating decimal.→ Express a repeating decimal as a fraction.→ Express a terminating decimal as a fraction.→ Provide an example where the decimal representation of a fraction is an approximation of its exact value.

PRIOR KNOWLEDGE

Students may have had experience with the following:

- Applying estimation strategies, including
 - front-end rounding
 - compensation
 - compatible numbersin problem-solving contexts.

- Applying mental mathematics strategies for multiplication, such as
 - annexing, then adding zeros
 - halving and doubling
 - using the distributive property
- Demonstrating an understanding of division (3-digit numerals by 1-digit numerals) with and without concrete materials, and interpreting remainders to solve problems.
- Describing and representing decimals (tenths, hundredths, thousandths) concretely, pictorially, and symbolically.
- Relating decimals to fractions (tenths, hundredths, thousandths).
- Comparing and ordering decimals (tenths, hundredths, thousandths) by using
 - benchmarks
 - place value
 - equivalent decimals
- Demonstrating an understanding of place value for numbers
 - greater than one million
 - less than one-thousandth
- Demonstrating an understanding of factors and multiples by
 - determining multiples and factors of numbers less than 100
 - identifying prime and composite numbers
 - solving problems involving factors or multiples

For more information on prior knowledge, refer to the following resource:

Manitoba Education and Advanced Learning. *Glance Across the Grades: Kindergarten to Grade 9 Mathematics*. Winnipeg, MB: Manitoba Education and Advanced Learning, 2015. Available online at www.edu.gov.mb.ca/k12/cur/math/glance_k-9/index.html.

RELATED KNOWLEDGE

Students should be introduced to the following:

- Demonstrating an understanding of the addition, subtraction, multiplication, and division of decimals to solve problems (for more than 1-digit divisors or 2-digit multipliers, technology could be used).
- Comparing and ordering fractions, decimals (to thousandths), and integers by using
 - benchmarks
 - place value
 - equivalent fractions and/or decimals
- Demonstrating an understanding of oral and written patterns and their corresponding relations.

- Demonstrating an understanding of circles by
 - describing the relationships among radius, diameter, and circumference of circles
 - relating circumference to pi
 - determining the sum of the central angles
 - constructing circles with a given radius or diameter
 - solving problems involving the radii, diameters, and circumferences of circles
- Expressing probabilities as ratios, fractions, and percents.

BACKGROUND INFORMATION

In previous grades, students learned that *fractions* and *decimals* are interchangeable names for the same quantity. In Grade 7 (learning outcome 7.N.3), students review multiple meanings for the term *fraction* and learn strategies for finding decimal and fraction equivalents. For learning outcome 7.N.4, students will sometimes use calculators and the understanding that a fraction also represents division to find the decimal equivalents for fractions that are not conveniently renamed in other ways (e.g., $\frac{1}{8}$ may be read as $1 \div 8$, which equals 0.125).

Fraction and Decimal Equivalents

All fractions have equivalent decimal names. The decimal names may have a definite number of digits. These are *terminating decimals*. A terminating decimal can be easily renamed as a fraction with a denominator that is a power of 10 (e.g., 0.125, read as 125 thousandths, and written as a fraction $\frac{125}{1000}$, which can be simplified to $\frac{1}{8}$).

When some fractions are renamed as decimals, the decimal number contains one or more digits that repeat in a continuous pattern indefinitely (e.g., $\frac{1}{3} = 0.333 \dots$). These are *repeating decimals*. The three dots indicating the digits continue without end are called an *ellipsis*. In North America, the common representation for repeating decimals is to write the number with one set of the repeating digits, and then draw a bar over the digits that form the repeating pattern ($0.\overline{3}$). The series of digits that repeat may be called a *period*. The bar is called a *vinculum*. Other notations include placing a dot over the digits at each end of the repeating sequence ($0.\dot{3}$.) or enclosing the repeating sequence in parentheses [$0.(3)$]. Repeating decimals may also be renamed as fractions ($\frac{1}{3}$). Characteristic patterns may be used to predict the decimal representation of these fractions and to predict the fraction representation of repeating decimals.

Note:

Students from varying cultural backgrounds may have different conventions for representing the repeating sequence. Students should be aware of all conventions, but should not be required to memorize the representations.

Provide students with learning activities that lead them to discover interesting patterns in the relationships between fraction and decimal equivalents. Investigating the patterns provides an opportunity to explore number sense. The situation with ninths may lead to a question of $0.\overline{9}$ versus 1. (Some patterns are listed for teacher reference in a table on the next page.)

To determine whether a fraction will result in a terminating or repeating decimal, simplify the fraction and consider the prime factors of the denominator. If the only prime factors of the denominator are 2s and/or 5s, the fraction will have a terminating decimal equivalent. The number of 2s and 5s may be used to predict the number of place value positions in the decimal equivalent. The relationship is

described below. If the denominator contains prime factors other than 2 or 5, the decimal number will be a repeating decimal. The maximum number of digits that may repeat will be one less than the denominator. This is sometimes the case when the denominator is a prime number. The decimal equivalents for fractions with the prime denominator 7 form a cyclic repeating decimal pattern with six repeating digits (142857).

Note:

These are interesting patterns for students to discover, but students are not required to memorize these relationships.

To predict the number of digits in a terminating decimal number, simplify the fraction and express the denominator as a product of prime factors. Count the number of 2s and the number of 5s in the product. Determine whether there are more 2s or more 5s. The number of times the most frequently occurring digit occurs in the prime product equals the number of place value positions in the decimal number.

Example:

$$\left(\frac{1}{8}\right)$$

8 written as a product of prime factors = $2 \times 2 \times 2$.

There are three 2s in the product and three decimal places in the decimal equivalent for $\frac{1}{8}$, which is 0.125.

$$\left(\frac{2}{8}\right)$$

$$\frac{2}{8} = \frac{1}{4}$$

4 written as a product of prime factors = 2×2 .

There are two decimal places in the decimal equivalent 0.25.

Some fractions and their repeating decimal equivalents are listed in the following table for reference. Give students opportunities to discover these patterns.

Fractions and Their Repeating Decimal Equivalents		
Denominator of the Fraction	Pattern in the Repeating Decimal	Example
7ths	<ul style="list-style-type: none"> ■ six repeating digits ■ digits are 142857 in a cyclic pattern 	$\frac{2}{7} = 0.\overline{285714}$
9ths	<ul style="list-style-type: none"> ■ single repeating digit ■ the numerator is the repeating digit 	$\frac{7}{9} = 0.\overline{7}$
99ths	<ul style="list-style-type: none"> ■ two repeating digits ■ the numerator is the repeating sequence 	$\frac{20}{99} = 0.\overline{20}$
999ths	<ul style="list-style-type: none"> ■ three repeating digits ■ the numerator is the repeating sequence 	$\frac{1}{999} = 0.\overline{001}$
11ths	<ul style="list-style-type: none"> ■ two repeating digits that are a multiple of 9 ■ the numerator is the factor $\times 9$ that equals the repeating sequence 	$\frac{3}{11} = 0.\overline{27}$

Rounding a decimal equivalent results in an approximation of the value of the fraction. Contexts or circumstances may dictate that a decimal number must be rounded to a specified number of digits. Many calculators round to the final digit in their display (e.g., a student's score of $\frac{12}{18}$ may be reported as 67%, $\frac{2}{3}$ of a metre may be measured as 67 cm). Each of these situations represents an approximation of the true value of the number. To express an exact value for a repeating decimal, indicate the repeating section with a vinculum, or write the fraction equivalent. To indicate that the number is an approximation of the true value, use a tilde mark (\sim), an approximately equal sign (\approx), or an equal sign with a dot over it (\doteq).

Note:
Similar to the notation for repeating decimals, students may have had prior exposure to one of these representations. All representations should be considered correct.

MATHEMATICAL LANGUAGE

decimal equivalent
decimal number
denominator
factor
fraction
fraction equivalent
multiple
numerator
prime number
product of prime factors
repeating decimal
simplify a fraction to lowest terms
terminating decimal

Optional language that may be used by teachers, but is not required of students

ellipsis
tilde
unit fraction
vinculum



Assessing Prior Knowledge

Materials:

- math notebooks
- calculators (optional)

Organization: Individual, pairs

Procedure:

1. Introduce and/or review the meaning of a prime number, factors, prime factors, and writing a number as the product of prime factors.*
2. Have each student use each of the digits 0 to 9 once to write five 2-digit numbers in his or her math notebook.
3. Next, have students write each of their numbers as a product of prime factors.
4. When students are finished with their individual work, ask them to exchange notebooks with a partner. Have them verify that the numbers in the product are all prime numbers and that the product is equal to the original number.

* Note:

In Grade 7, students are not formally exposed to prime factorization. It is an achievement indicator in Grade 8 Mathematics in the study of squares and square roots, and a learning outcome in Grade 10 Introduction to Applied and Pre-Calculus Mathematics. Provide students with guided support when prime factorization is required.

Variations:

- Supply numbers and a template for finding the prime factors.
- Have students create 3-digit numbers, using each digit no more than twice.

Observation Checklist

- Listen to and observe students' responses to determine whether students can do the following:
 - Identify factors and multiples of a number correctly.
 - Identify prime factors correctly, with guidance.
 - Use mental mathematics strategies, including divisibility rules, and using calculators when required.



Assessing Prior Knowledge

Materials:

- demonstration board, chalk or markers, erasers
- a list of numbered division questions specifying the format of the answers (e.g., fraction remainder, number of decimal places) and the answers
- copies of each numbered question on individual papers (the number of copies equals the number of teams)
- a reward for the winners (optional)

Organization: Teams—groups of three (of mixed ability) are ideal, but the number depends on the size of the board space available and the number of students in the class.

Procedure:

1. Have teams line up perpendicular to the board. The first players on all teams position themselves at the board and draw a point box at the top of the board, while the other players remain about two metres behind (or whatever distance works). Remind players to write large enough and high enough so you can see their work.
2. Provide the first player on each team with a division question, and state the form for expressing the answer (e.g., fraction remainder, number of decimal places). Students record their respective questions on the board, find the solutions, and draw a box around the quotients when their responses are complete. Establish a signal that students can use to get your attention for assessing their responses.
3. Respond to a student's signal and verify his or her response. If the response is correct, the student records a point in the team's point box. This player then comes to get the next question from you, dictates the question to the next team member in line, and then returns to the end of the line for his or her team.
4. The next team member goes to the board, and repeats the process.
5. When students have had sufficient time to work on the division questions, end the game, and declare the winning team to be the one with the most points. Provide a reward (optional).

Variations:

- Establish any desired rules about obtaining help from teammates.
- Have all teams work on the same question at the same time. You decide the time available to complete the question, call out the time, and provide the answer. Students award their team with a point if their answer is correct. Players return to the end of their team line, and you call out the next question.
- Have students create the questions and answer keys.
- Have students call out the questions and the answers, giving you more time to observe.
- Have teams complete the work on large pieces of scrap paper at table groups and show their work on request.

Observation Checklist

- Listen to and observe students' responses to determine whether students can do the following:
 - Apply an appropriate division algorithm.
 - Recognize that when a remainder repeats, the quotient has entered a repeating pattern.
 - Express a fraction as a terminating or repeating decimal.
 - Sort a set of fractions as repeating or terminating decimals.
 - Provide an example where the decimal representation of a fraction is an approximation of its exact value.

Suggestions for Instruction

- **Predict the decimal representation of a fraction using patterns**
(e.g., $\frac{1}{11} = 0.\overline{09}$, $\frac{2}{11} = 0.\overline{18}$, $\frac{3}{11} = ? \dots$).
- **Sort a set of fractions as repeating or terminating decimals.**
- **Express a fraction as a terminating or repeating decimal.**
- **Express a repeating decimal as a fraction.**
- **Express a terminating decimal as a fraction.**
- **Provide an example where the decimal representation of a fraction is an approximation of its exact value.**

Materials:

- BLM 5–8.10: Base-Ten Grid Paper
- base-10 blocks (10 flats, 10 rods, and 10 units for each student)
- three-dimensional or paper models
- small strips to represent a unit block divided into 10 columns and no rows
- three food items (e.g., candy bars, granola bars), of uniform size, that can easily be cut into equal portions (or enough to share with the whole class)
- demonstration board
- math notebooks
- calculators (at least one of which rounds repeating decimals)

Organization: Whole class

Procedure:

1. Lead a class demonstration and discussion about representing a fraction quantity with a base-10 place value system. Use base-10 blocks, and include the concepts of terminating and repeating decimals, using division to represent a fraction, notations that represent exact quantities, and approximation.
2. The purpose of numbers is to provide a way to communicate about quantity. Share a candy bar equally between two students. Ask how much of the candy bar each one received. Write $\frac{1}{2}$ on the board. One-half of the candy bar describes exactly what each student received. It's an exact number. Ask whether it is possible to name that number with the base-10 place value system.

3. Have students demonstrate the action with base-10 models. The flat represents one candy bar. The place value system dictates that if the flat is cut, it must be cut into 10 equal pieces. Review that there are 10 pieces (use the digits 0 to 9) in each place value position. If students have not used base-10 blocks to represent decimals or fractions before, you may need to make it very clear that they are using the blocks differently here than when they used them for whole-number operations. They are using them because they are nicely “cut” into tenths. If one flat represents one candy bar, and individuals are going to share it, the one flat must first be “cut” into 10 pieces. Don’t actually cut the block; instead, swap it for 10 rods. Each rod represents one-tenth of one. Now share the candy bar block with two imaginary people. How much does each one receive? Each one receives five rods, which are named five-tenths, and written as 0.5. Record 0.5 on the board. It is an exact number too. Five-tenths describes the exact quantity here.
4. Repeat the process (steps 2 and 3) with the second candy bar, sharing it among three students. Ask how much candy bar each one received. Record $\frac{1}{3}$ on the board. One-third of the candy bar describes exactly what each student received. It’s an exact number. Ask whether we are able to name that number with the base-10 place value system.
5. Have students model sharing their “flat” candy bar with three imaginary people. Each will get three-tenths, and one-tenth will be left over. Explore options for writing the number. Can we write 0.3 as $\frac{1}{3}$? Record this question on the board with a question mark. That would be mixing two languages in the same word, which would be confusing. Go back and “cut” up the tenth rod and share the pieces. Remember, the only possible “cut” is into 10 equal pieces. Swap the rod for 10 small cubes. This results in 0.33 and one-tenth of a tenth left to share among three. You need to cut that piece into 10 again in order to share it. You are out of blocks, so use the grid paper to represent the action. The grid represents one little block cut into 10 pieces. Share the little pieces, and one will be left again. Students should realize this is going to go on forever. A similar situation was encountered when students explored divisibility rules for 3. Explore possibilities for writing the number. Introduce the term *repeating decimal number* and the concept of drawing a bar over the 3 as a notation that this 3 repeats forever.
6. Repeat the process (steps 2 and 3), with the third candy bar shared among four students. Write $\frac{1}{4}$ on the board, and then 0.25. Both are exact numbers. They describe the exact quantity.
7. Note that $\frac{1}{3}$ is named a *repeating decimal* because the sharing is never complete, as the value 3 repeats in every place value position indefinitely. A repeating decimal may have more than one repeating digit, but the pattern will never stop. Observe that $\frac{1}{2}$ and $\frac{1}{4}$ were shared completely in the place value model. The numerals had a definite number of digits. Decimal numbers with a definite number of digits are called *terminating decimals*. Terminating decimals may have many digits, but there is no repeating pattern, and they stop, or there is zero repeating.

8. In this learning activity, the actions of cutting and sharing the bars denote division. We can read fractions as division operations and obtain names for the fraction in our place value system. Demonstrate long division on the board, or have students use their math notebooks to perform long division for $1 \div 2$, $1 \div 3$, and $1 \div 4$, and compare their results to the models. Ask students to obtain a decimal name for $\frac{1}{6}$. Ask whether these are exact names for the fractions.
9. Ask students to use calculators to convert the unit fractions from $\frac{1}{2}$ to $\frac{1}{6}$ to decimal numbers, and have them record the equivalents in a table in their math notebooks. Ask students to share the results. Some students will likely have calculators that round $\frac{1}{6}$ to 0.16666667.

Note:

Rounding a decimal number, or failing to provide an indication that the decimal repeats, is an approximation, not an exact value, and it ought to be noted as such. It also shows students whether the number of digits equals or exceeds the capacity of the calculator display. Students cannot rely on the calculator to verify whether a fraction is represented as a terminating or repeating decimal.

Variation:

- Use smaller decimal examples, sharing with fifths, sixths, or eighths. With these variations, the model is a little more tedious to use and the candy bar pieces are small.



Observation Checklist

- Listen to and observe students' responses to determine whether students can do the following:
 - Predict the decimal representation of a fraction using patterns (e.g., $\frac{1}{11} = 0.\overline{09}$, $\frac{2}{11} = 0.\overline{18}$, $\frac{3}{11} = ? \dots$).
 - Sort a set of fractions as repeating or terminating decimals.
 - Express a fraction as a terminating or repeating decimal.
 - Express a repeating decimal as a fraction.
 - Express a terminating decimal as a fraction.
 - Provide an example where the decimal representation of a fraction is an approximation of its exact value.

Suggestions for Instruction

- **Express a fraction as a terminating or repeating decimal.**
- **Provide an example where the decimal representation of a fraction is an approximation of its exact value.**

Materials:

- coloured counters
- chart paper

Organization: Pairs, whole class

Procedure:

1. Have pairs of students make up one multiple-choice question to ask the class, or a target group within the class.

Sample Questions:

- **For all students:** If you could have a superpower, would it be time travel, rocket speed, or immortality?
 - **For the girls:** As a lunchtime activity, do you prefer intramurals, school governance, free time, homework help, or games club?
 - **For the boys:** Is your favourite season spring, summer, fall, or winter?
2. Have students collect the data from the class or target group.
 3. Provide students with access to coloured counters, and have them represent the collected data in the form of a circle graph. Once you have had a chance to look at their circle graphs, ask students to represent their circle graphs on chart paper, labelling the titles of each piece of the pie on the front of the chart paper and recording their responses to the following questions on the reverse side of the chart paper for future reference:
 - a) What percent of this class or target group is represented by each piece of the pie?
 - b) What fraction would best represent each piece of the pie?
 - c) What decimal would best represent each piece of the pie?
 - d) Make a statement about the largest section of the pie or circle graph.

Note:

Students' work in this learning activity is meant to address repeating and terminating decimals and their fractional equivalents, and should remain general with respect to circle graphs. Learning outcome 7.SP.3 relates specifically to circle graphs. You might find this to be a natural opportunity to make connections between the Number and Statistics and Probability strands.

4. Have students rotate, in pairs, to the circle graphs created by the rest of the class and answer the following questions:
 - a) What percent of this class or target group is represented by each piece of the pie?
 - b) What fraction would best represent each piece of the pie?
 - c) What decimal would best represent each piece of the pie?
 - d) Make a statement about the largest section of the pie or circle graph.
5. Gather as a class and discuss the following questions:
 - a) What can be said about representing the data on a circle graph?
 - b) Which is the best way to view this data (as fractions, decimals, or percents)?
 - c) Are exact or approximate values needed on the circle graph to represent the fraction of students? Give examples of when an exact representation is needed and when an approximate representation is needed.



Observation Checklist

- Listen to and observe students' responses to determine whether students can do the following:
 - Express a fraction as a repeating decimal.
 - Express a fraction as a terminating decimal.
 - Represent a number in a variety of ways.
 - Estimate a value based on a pictorial representation.
 - Communicate mathematically.

Suggestions for Instruction

- **Predict the decimal representation of a fraction using patterns**
(e.g., $\frac{1}{11} = 0.\overline{09}$, $\frac{2}{11} = 0.\overline{18}$, $\frac{3}{11} = ? \dots$).
- **Sort a set of fractions as repeating or terminating decimals.**
- **Express a fraction as a terminating or repeating decimal.**

Materials:

- BLM 7.N.4.1: Table for Recording Fractions and Their Decimal Equivalents (or another chart for recording fraction-decimal equivalents, such as the one students began in their math notebooks in the previous learning activity)
- demonstration board
- calculators
- Venn diagram or T-chart (optional)

Organization: Whole class, individual, small groups

Procedure:

In the previous learning activity, students identified the decimal equivalents for the unit fractions $\frac{1}{2}$ to $\frac{1}{6}$ and classified them as repeating or terminating decimals. They used calculators and long division to confirm their classifications and noted the difference between exact and approximate representations. In this learning activity, students investigate patterns in the unit fractions $\frac{1}{2}$ to $\frac{1}{20}$ to develop generalizations useful for predicting terminating or repeating decimals and expressing fraction and decimal equivalents.

1. Review the concepts addressed in the previous learning activity. Stimulate student curiosity by asking if they think it is possible to predict whether a decimal representation will terminate or repeat.
2. Launch an inquiry task to find an answer to the question of predictability. Looking at examples and discovering patterns gives a basis for making predictions that can then be confirmed and generalized into rules.

Possible steps that students can follow for the inquiry task are listed below.

- a) Specify the question to investigate. (How do you predict whether a fraction number is represented by a terminating or repeating decimal number?)
- b) Select an element that you think may be the determining factor (e.g., numerator or denominator). It is not possible to examine all elements at once, so select one to investigate. The only elements in a fraction are the numerator and the denominator. Look at the list created so far for a hint as to which one to choose.

The fraction $\frac{1}{3}$ repeats, as does $\frac{1}{6}$.

What about $\frac{2}{3}$ or $\frac{2}{6}$? Fraction names for 1 need not be considered because they all equal 1.0. The fraction $\frac{1}{4}$ terminates.

What about $\frac{2}{4}$ and $\frac{3}{4}$?

Note:

The important thing here is to have students investigate the denominator as the determining factor.

- c) Generate a list of examples that isolate the chosen factor. (Suggest beginning with unit fractions with denominators 2 to 10 and numerators of 1.)
- d) Examine the list of examples for a common element or patterns that describe the relation. Use a Venn diagram or T-chart to organize findings. (These repeating decimals have denominators 3, 6, 7, and 9. The terminating decimals have denominators 2, 4, 5, 8, and 10. Notice 2, 4, and 8 are all divisible by 2, and 5 and 10 are divisible by 5. To add more examples, extend the list to denominators to 20. A group effort is advised for 17 and 19, as these denominators have a long repeating period. Students may be excited to note that the denominators of all the terminating decimals have 2 and/or 5 as factors. See the $2 \times 5 = 10$ base-10 connection.)

- e) Create a descriptive phrase on which to base predictions. (Terminating decimals have denominators that are multiples of 2 and/or 5. The denominators have no prime factors other than 2 and/or 5. Repeating decimals have denominators with prime factors other than 2 or 5.)
 - f) Test your predictions with several new examples. (Any fractions will do. Consider including various numerators such as $\frac{8}{32}$ and $\frac{11}{55}$, as well. Students should note that equivalent fractions have the same decimal representations.)
 - g) If all predictions are correct, it's time to create a rule. Be open to the fact that some examples may disprove your rule, and you will need to begin at step (d) again, or note exceptions to your rule. (Ensure that, at some point, students realize a fraction must be simplified to apply their rule.)
3. Record and celebrate students' inquiry findings by playing a terminating or repeating decimal game, such as the one suggested in the next learning activity.

Variations:

- Guide the whole class as a group, or have students work individually or in small groups based on students' ability to conduct inquiries.
- Provide templates to guide sample selections, and provide questions to prompt generalizations for inquiries.
- Supply students with the rule, and explain how it is based on factors. Have them use prime factor denominators in several predetermined fractions to determine whether the fractions are represented by terminating or by repeating decimals.
- Following the inquiry, present students with a list of fractions, and ask them to sort the fractions according to whether they have terminating or repeating decimal equivalents. Have students supply prime factors as evidence of their decision.



Observation Checklist

- Listen to and observe students' responses to determine whether students can do the following:
 - Express a fraction as a terminating or repeating decimal.
 - Sort a set of fractions as repeating or terminating decimals.
 - Express a fraction as a terminating or repeating decimal.
 - Make connections among repeating decimals, terminating decimals, and place value.

Suggestions for Instruction

- **Sort a set of fractions as repeating or terminating decimals.**
- **Express a fraction as a terminating or repeating decimal.**

Materials:

- tic-tac-toe frames or grids (of various sizes), such as the following:
 - BLM 7.N.3.1A: Tic-Tac-Toe Frames
 - BLM 7.N.3.1B: Tic-Tac-Toe Frames (Medium Challenge)
 - BLM 7.N.3.1C: Tic-Tac-Toe Frame (Ultimate Challenge)
- calculators
- notebook paper
- pens of two different colours

Organization: Pairs

Procedure:

Pairs of students play a tic-tac-toe game on a grid of any size. The object is to create a line of fractions whose equivalents are either terminating or repeating decimals and to monitor the fractions played by the opponent to verify whether they represent terminating or repeating decimal numbers.

1. The players each choose a colour and decide who will play fractions represented by terminating decimals, and who will play fractions represented by repeating decimals. They decide on the size of grid on which to play, and who will go first.
2. On the first move, a player selects which square to play in, creates a fraction represented by her or his type of decimal representation, and writes the fraction clearly in the selected square.
3. The opponent verifies the play, using a calculator if necessary. If the player has played a fraction represented by a terminating decimal instead of a repeating decimal, or vice versa, the opponent may capture the play by circling or re-colouring the fraction with his or her own colour.
4. The next player plays, repeating steps 2 and 3.
5. Play continues until one player wins the round by connecting a horizontal, vertical, or diagonal line of repeating or terminating decimals. If a player fails to notice a connecting line on his or her turn, the opponent may draw the connection and declare himself or herself the winner. If the challenger is incorrect, the other player is a double winner.

6. Students have two options to end the game:
 - a) The game is over after a specified amount of time has passed.
 - b) Play stops when one player reaches a target number of wins.

Variations:

- Vary the size of the grid the players use for the game.
- Have students design their own game.
- Prepare a list of fractions. Have students sort the fractions into two groups, repeating decimals or terminating decimals.



Observation Checklist

- Listen to and observe students' responses to determine whether students can do the following:
 - Sort a set of fractions as repeating or terminating decimals.
 - Express a fraction as a terminating or repeating decimal.

Suggestions for Instruction

- **Predict the decimal representation of a fraction using patterns** (e.g., $\frac{1}{11} = 0.\overline{09}$, $\frac{2}{11} = 0.\overline{18}$, $\frac{3}{11} = ? \dots$).
- **Sort a set of fractions as repeating or terminating decimals.**
- **Express a fraction as a terminating or repeating decimal.**
- **Express a repeating decimal as a fraction.**
- **Express a terminating decimal as a fraction.**

Materials:

- BLM 7.N.4.1: Table for Recording Fractions and Their Decimal Equivalents (or another chart for recording fraction-decimal equivalents, such as the one students began in their math notebooks in a previous learning activity)
- demonstration board
- calculators
- Venn diagrams or T-charts (optional)
- paper (small size), colours, glue, scissors, or computer technology for posters (optional)

Organization: Individual, small group, or whole class (depending on the interest and inquiry ability of students in the class)

Procedure:

1. Ask students to suggest other predictions that may be interesting or useful to investigate.
 - Can we predict the number of digits that will appear in the decimal, or in the repeating period?
 - Can the identity of the digits in a fraction–decimal equivalent be predicted?
 - Be sure to investigate fractions with denominators of 9, 99, 999, and 11.
 - The patterns of denominators 90 and 7 are also interesting investigations.
2. Have students conduct inquiries to find patterns on which to base predictions. General rules for each investigation are listed below.
 - a) Specify the question to investigate.
 - b) Select an element that you think may be the determining factor.
 - c) Generate a list of examples that isolate the chosen factor.
 - d) Examine the list of examples for a common element or patterns that describe the relation.
 - e) Create a descriptive phrase on which to base predictions.
 - f) Test your prediction with several new examples. This may lead back to step (d).
 - g) Create a rule or generalization.
3. When students have a set of rules or generalizations, ask whether they could make predictions about the fraction represented by a decimal number. From all their observations, students should note the reverses. For repeating decimals, if $0.\overline{7}$ is an equivalent representation of $\frac{7}{9}$, then $\frac{7}{9}$ is the equivalent representation of $0.\overline{7}$.
4. Have students share their generalizations and create posters that outline general rules about converting fraction and decimal equivalents.

Variations:

- Provide students with templates to guide sample selections, and questions to prompt generalizations for inquiries.
- Provide students with a list of generalizations. Guide them through examples that prove each generalization.



Observation Checklist

- Listen to and observe students' responses to determine whether students can do the following:
 - Predict the decimal representation of a fraction using patterns
(e.g., $\frac{1}{11} = 0.\overline{09}$, $\frac{2}{11} = 0.\overline{18}$, $\frac{3}{11} = ? \dots$).
 - Sort a set of fractions as repeating or terminating decimals.
 - Express a fraction as a terminating or repeating decimal.
 - Express a repeating decimal as a fraction.
 - Express a terminating decimal as a fraction.
 - Communicate mathematical understanding.
 - Reason in order to make connections to prior understanding.

Suggestions for Instruction

- **Predict the decimal representation of a fraction using patterns**
(e.g., $\frac{1}{11} = 0.\overline{09}$, $\frac{2}{11} = 0.\overline{18}$, $\frac{3}{11} = ? \dots$).
- **Match a set of fractions to their decimal representations.**
- **Sort a set of fractions as repeating or terminating decimals.**
- **Express a fraction as a terminating or repeating decimal.**
- **Express a repeating decimal as a fraction.**
- **Express a terminating decimal as a fraction.**

Materials:

- calculators
- a list of generalizations about converting fraction and decimal equivalents (created in previous learning activities)
- BLM 7.N.3.4: Choose Your Question
- paper (small size), colours, glue, scissors, or computer technology for posters (optional)
- computers or other technology (optional)

Organization: Individual or small groups

Procedure:

As a culminating activity, have students create and participate in a variety of games that will help them to demonstrate an understanding of the relationship between repeating decimals and fractions, and terminating decimals and fractions.

1. Have students use the general rules about converting fraction and decimal equivalents that they created previously to create a Fraction and Decimal Expressions Trivia game, with players having to collect designated points from each category. Alternatively, have students use the templates from BLM 7.N.3.4: Choose Your Question to create a Choose the Question and Points game in an effort to score the highest points. Students may also wish to play some other game of their choice.
2. The game categories for the selected game are as follows:
 - fraction/decimal patterns
 - sorting fractions as repeating or terminating decimals
 - expressing a fraction as a terminating or repeating decimal
 - expressing a repeating decimal as a fraction
 - expressing a terminating decimal as a fraction
3. The class could host a grand competition.

Variations:

- Have students create a challenge quiz sheet and an answer key with an assortment of terminating and repeating decimals and fraction representations. Create criteria for the quiz, including questions about
 - fraction/decimal patterns
 - sorting fractions as repeating or terminating decimals
 - expressing a fraction as a terminating or repeating decimal
 - expressing a repeating decimal as a fraction
 - expressing a terminating decimal as a fraction

Students may use computers or other technology to create their quiz. Photocopy the quiz sheets, and ask students to exchange challenges with a partner. The partners complete and correct each other's challenges.



Observation Checklist

- Listen to and observe students' responses to determine whether students can do the following:
 - Predict the decimal representation of a fraction using patterns
(e.g., $\frac{1}{11} = 0.\overline{09}$, $\frac{2}{11} = 0.\overline{18}$, $\frac{3}{11} = ? \dots$).
 - Sort a set of fractions as repeating or terminating decimals.
 - Express a fraction as a terminating or repeating decimal.
 - Express a repeating decimal as a fraction.
 - Express a terminating decimal as a fraction.

Number (7.N.5)

Enduring Understanding(s):

The principles of operations used with whole numbers also apply to operations with decimals, fractions, and integers.

Number sense and mental mathematics strategies are used to estimate answers and lead to flexible thinking.

General Learning Outcome(s):

Develop number sense.

SPECIFIC LEARNING OUTCOME(S):	ACHIEVEMENT INDICATORS:
<p>7.N.5 Demonstrate an understanding of adding and subtracting positive fractions and mixed numbers, with like and unlike denominators, concretely, pictorially, and symbolically (limited to positive sums and differences). [C, CN, ME, PS, R, V]</p>	<ul style="list-style-type: none">→ Model addition and subtraction of positive fractions or mixed numbers using concrete representations, and record symbolically.→ Determine the sum of two positive fractions or mixed numbers with like denominators.→ Determine the difference of two positive fractions or mixed numbers with like denominators.→ Determine a common denominator for a set of positive fractions or mixed numbers.→ Determine the sum of two positive fractions or mixed numbers with unlike denominators.→ Determine the difference of two positive fractions or mixed numbers with unlike denominators.→ Simplify a positive fraction or mixed number by identifying the common factor between the numerator and denominator.→ Simplify the solution to a problem involving the sum or difference of two positive fractions or mixed numbers.→ Solve a problem involving the addition or subtraction of positive fractions or mixed numbers, and determine if the solution is reasonable.

PRIOR KNOWLEDGE

Students may have had experience with the following:

- Demonstrating an understanding of fractions by
 - explaining that a fraction represents a portion of a whole divided into equal parts
 - describing situations in which fractions are used
 - comparing and ordering fractions with like and unlike denominators
 - naming and recording fractions for the parts of a whole or a set
 - modelling and explaining that for different wholes, two identical fractions may not represent the same quantity
 - creating sets of equivalent fractions
- Relating improper fractions to mixed numbers.
- Describing and applying mental mathematics strategies, such as
 - skip-counting from a known fact
 - using doubling or halving
 - using doubling and adding one more group
 - using patterns in the 9s facts
 - using repeated doublingto develop recall of basic multiplication facts to 9×9 and related division facts.
- Applying mental mathematics strategies for multiplication, such as
 - annexing, then adding zeros
 - halving and doubling
 - using the distributive property
- Demonstrating an understanding of factors and multiples by
 - determining multiples and factors of numbers less than 100
 - identifying prime and composite numbers
 - solving problems involving factors or multiples
- Demonstrating an understanding of ratio, concretely, pictorially, and symbolically.
- Demonstrating an understanding of percent (limited to whole numbers) concretely, pictorially, and symbolically.

For more information on prior knowledge, refer to the following resource:

Manitoba Education and Advanced Learning. *Glance Across the Grades: Kindergarten to Grade 9 Mathematics*. Winnipeg, MB: Manitoba Education and Advanced Learning, 2015. Available online at www.edu.gov.mb.ca/k12/cur/math/glance_k-9/index.html.

RELATED KNOWLEDGE

Students should be introduced to the following:

- Demonstrating an understanding of the relationship between repeating decimals and fractions, and terminating decimals and fractions.
- Comparing and ordering fractions, decimals (to thousandths), and integers by using
 - benchmarks
 - place value
 - equivalent fractions and/or decimals

BACKGROUND INFORMATION

Topic Overview

Fractions are commonly used in a variety of contexts in daily life. They are used to indicate quantities other than a whole. Fractions can be used to measure money, time, and distance. Fraction measurements are used in construction and cabinetry, in cooking, in art and design projects, and in sports. They are used to conduct tests and experiments, to gauge liquids, to keep track of periods at sporting events, and so on. Fractions are important for sharing anything from chocolate bars and pies to splitting restaurant bills.

In Grade 7, students develop their mathematical literacy by extending their conceptual understanding of fractions to combining and comparing fractional quantities using addition and subtraction.

Fractions name quantities between whole numbers. The part between the wholes can be divided into any number of equal parts. The number of equal parts in one whole is the denominator of the fraction, and the number of parts being referred to forms the numerator. Fractions are an extension of the whole number system, and the same principles for adding and subtracting whole numbers apply to adding and subtracting fractions. Understanding operations with whole numbers and having a good conceptual understanding of fractions provides an important foundation for both adding and subtracting fractions. When teaching operations with fractions, encourage students to focus on meaning and to make sense of a variety of contextual problems, regardless of whether they are working with proper fractions or with mixed numbers.

Many people, both students and adults, have unfriendly relationships with fractions. This indicates the importance of emphasizing number sense and concepts when working with fractions.

Conceptual Understandings

Before students perform operations, it is important to verify their conceptual understandings.

The term *fraction* has several meanings. *Fraction notation* is used to represent a “cut” or a part of a whole unit or region, a part of a group or set, a measurement, or a point on a number line. It is also used to represent a ratio or a portion of a turn, and to indicate the division operation. Ensure that students can record and interpret these different meanings.

The quantity represented by a fraction depends on the size of the whole. For example, $\frac{1}{4}$ of Prince Edward Island represents a different area than $\frac{1}{4}$ of Quebec, and $\frac{1}{5}$ of 100 represents a different quantity than $\frac{1}{5}$ of 10.

The numerator, or the top number of the fraction, indicates the number of parts in the fraction, and the denominator, or the bottom number, represents the type of part or unit size of the fraction. When adding or subtracting any numbers, the value or size of units must be the same. If the distance from a given point to your house is 2 km, and 500 m more to the park, it is incorrect to combine the numbers for a total distance of 502. It is necessary to convert the measurements to common units before combining them. For example, 2 km plus 0.5 km totals 2.5 km, or 2000 m plus 500 m totals 2500 m. These distances are equivalent. Fractions that have the same denominator, such as $\frac{1}{5} + \frac{3}{5}$, can easily be combined as $\frac{4}{5}$, but a collection of fractions might have different denominators. The different denominators indicate different types or units of measure that must be related to common reference points, or converted to common units, before adding or subtracting them. Ensure that students are able to create and identify equivalent names for fractions.

Some equivalent fractions, such as $\frac{1}{2}$ and $\frac{2}{4}$, are easily recognizable. Proficiency in identifying common factors and multiples facilitates renaming less recognizable fractions. Student will have a much easier time identifying factors and multiples if they have ready access to multiplication and division facts, and if they can apply divisibility rules.

Fraction notations may represent different meanings, and not all fraction meanings can be combined in the same manner. When considering the “cut” meaning of a fraction, it is quite clear that $\frac{1}{2}$ of a pizza and $\frac{1}{2}$ of a pizza can be combined to form the equivalent of 1 whole pizza, as long as all the pizzas are the same size. However, if you wrote a test, and answered $\frac{1}{2}$ of the questions in Part A correctly and $\frac{1}{2}$ of the questions in Part B correctly, you cannot combine the two parts and say you answered 1 test correctly. In this case, the fractions are parts of sets. When you combine them, you increase both the number of selected parts and the number of parts in the set. The score totals $\frac{2}{4}$.

Likewise, if you represent $\frac{1}{6}$ of the members in your family, and your friend represents $\frac{1}{3}$ of the members in her family, and you are asked to combine these fractions, you may be tempted to say $\frac{1}{3} + \frac{1}{6} = \frac{1}{2}$. Ask, $\frac{1}{2}$ of what? You and your friend do not represent $\frac{1}{2}$ of the members of both families. These fractions represent part of a set. The sets in the addends are not the same set referred to in the answer. Your friend and you would represent $\frac{2}{9}$ of both families. You need to combine the members composing the set, as well as the numerators in each set. If you wanted to view the fractions as ratios, and you wanted to find the average portion of each family you represent, you could add the fractions and divide by 2 to obtain $\frac{1}{4}$. This illustrates the importance of students having both number sense and an understanding of the different meanings of fractions in order to add and subtract them correctly.

Adding and subtracting whole numbers sometimes requires regrouping, or carrying and borrowing. Conversions and regrouping between mixed numbers and improper fractions provide regrouping opportunities for operations with fractions. Students require the ability to make these conversions.

Focus of Instruction

Some mathematics teaching resources begin instruction with common denominators and addends with sums that are less than one. They then move to subtraction with common denominators, with the stipulation that the smaller fraction is removed from the larger fraction. Next, they progress to questions in which one denominator is a multiple of the other, and then to questions in which both denominators must be changed. Then they move to sums larger than one, and finally to mixed numbers. The progression is logical and increases in complexity. Students may, however, have difficulty with fraction operations if they focus or depend on remembering a sequence of steps they must follow to complete the operation. Students are more likely to internalize concepts if they have the opportunity to apply number sense to solving problems.

If students have a strong understanding of fraction concepts and whole number operations, and if teaching is focused on making meaning in a problem-solving context, it is not necessary to begin instruction with common denominators, and follow a set progression. Instead, present problems as realistic scenarios, and encourage students to use manipulatives and informal methods to arrive at solutions. Use friendly fractions that can easily be represented with manipulatives or drawings, and fractions that can easily be related to one another, such as quarters and eighths. An example of a friendly fraction combination is thirds and sixths. An example of an unfriendly fraction combination is fifths and twelfths. Using friendly fractions makes it easier for students to find equivalent units and helps them build confidence in the strategies they are developing. Highlight the generalizations that students make by connecting them to symbolic models for adding and subtracting fractions.

Encourage students to use rounding and benchmarks to make estimates. Estimates help students to focus on meaning and to create target zones for their solutions. The benchmarks of 0, $\frac{1}{2}$, and 1 (or 5, $5\frac{1}{2}$, 6, and so on) are useful when adding and subtracting fractions. Include problems relating to the various meanings of subtraction, such as take away or compare, and problems relating subtraction to addition by finding the missing addend. Provide students with opportunities to share and to assess one another's strategies.

Concrete and Pictorial Models

Concrete materials include fraction circles, fraction bars, fraction strips combined with number lines, metric rulers, and metre sticks, a collection of equivalent numbers lines with different unit divisions, base-10 blocks, Cuisenaire rods, pattern blocks, clocks, and money. Use commercially available products, or have students construct the materials by measuring them or by using blackline masters provided (e.g., BLM 5–8.12: Fraction Bars).

Students can generate simple pictures and diagrams to represent fractions and their combinations. Be aware that inaccurate drawings can lead to inaccurate results, especially when using circles. Minimize inaccuracies by supplying grid paper for drawing rectangles. Templates to represent circles, rulers, or number lines with equal intervals are also useful.

Equivalent fractions and combinations of fractions with unlike denominators can be represented by using grid drawings and by placing counters on the specified numbers of squares, or by colouring them. The denominators of the two fractions determine the number of rows and columns in the grid, and the numerators determine the number of squares in the grid that must be coloured or covered with counters.

Example:

Represent $\frac{2}{5} + \frac{1}{3}$ with a grid having five columns and three rows. Cover two columns to represent $\frac{2}{5}$, and cover one row to represent $\frac{1}{3}$. Rearrange the counters so there is only one counter per square. Of the 15 squares, 11 are covered, so the sum is $\frac{11}{15}$.

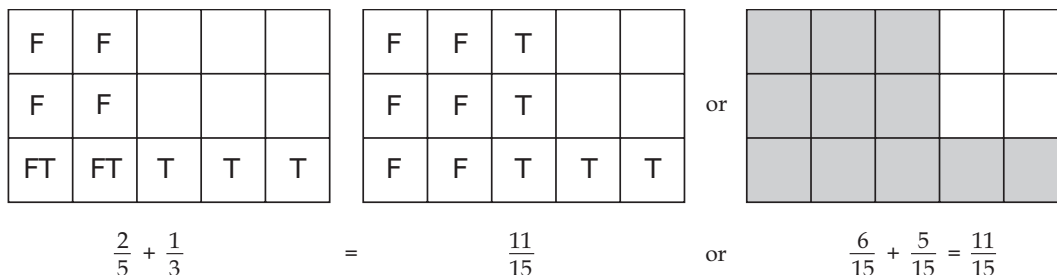

Equivalent fractions with common denominators are also evident in the drawing.

$\frac{2}{5}$ covers six squares or $\frac{6}{15}$ of the grid, so $\frac{2}{5} = \frac{6}{15}$.

$\frac{1}{3}$ covers five squares or $\frac{5}{15}$ of the grid.

Therefore, $\frac{1}{3} = \frac{5}{15}$. Combined, $\frac{6}{15}$ plus $\frac{5}{15}$ total $\frac{11}{15}$.

Similar grids can also be created by folding a piece of paper horizontally x number of times to represent one denominator, and then vertically y number of times to represent the other denominator. The numerators can be represented by placing counters in the rectangles of the grid or by colouring them.

Examples with Pattern Blocks:

Use pattern blocks for fractions of halves, thirds, and sixths.

- Students may cover the hexagon with six triangles.

So, $\frac{1}{6} + \frac{1}{6} + \frac{1}{6} + \frac{1}{6} + \frac{1}{6} + \frac{1}{6} = \frac{6}{6} = 1$.

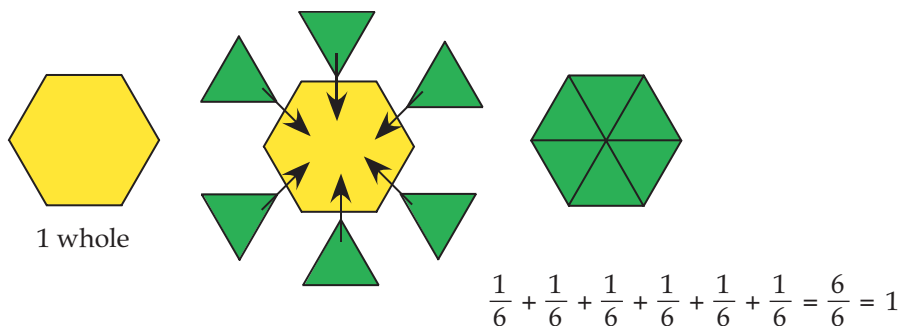

This is also $\frac{2}{6} + \frac{2}{6} + \frac{2}{6} = 1$ or $\frac{6}{6}$, or $\frac{3}{6} + \frac{3}{6} = 1$ or $\frac{6}{6}$.

Also include related subtraction possibilities.

- Models may also include combinations of fractions, such as $\frac{1}{3} + \frac{1}{3} + \frac{1}{6} + \frac{1}{6} = 1$.

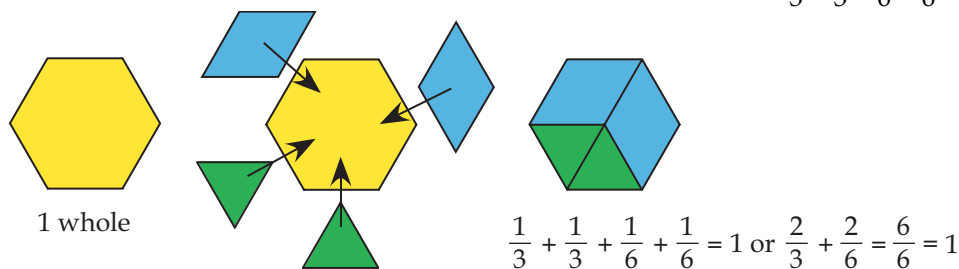

Also include related subtraction possibilities.

Examples with Rods:

- The use of rods allows for various equivalent fraction representations, depending on which rod represents the whole (e.g., halves and quarters of 4 and 8, halves and thirds of 6, thirds and ninths of 9, halves and fifths of 10), and allows for connections to common factors and multiples.
- With Cuisenaire rods, students can choose any rod to represent a whole. If they choose the rod that is eight white squares long, then the 8 cm brown rod is the whole. The 8 cm rod can be covered with four red 2 cm rods or with two purple 4 cm rods, or a combination of 2 cm and 4 cm rods. Note that fractions are equal parts of a particular whole.

Examples with Circles:

- Circles can be divided into any fractional segments. For example, a blank clock face with minute divisions can represent multiple fractions and many equivalents, such as halves, thirds, fourths, fifths, sixths, tenths, twelfths, fifteenths, twentieths, and thirtieths.

Examples with Fraction Strips:

- Fraction strips are convenient models because there are multiple fraction sizes for the same size of a whole. They represent fractions as parts of whole numbers. Also, these strips can be joined together on the coordinating number lines to match sums that are greater than 1. Demonstrate how this works.

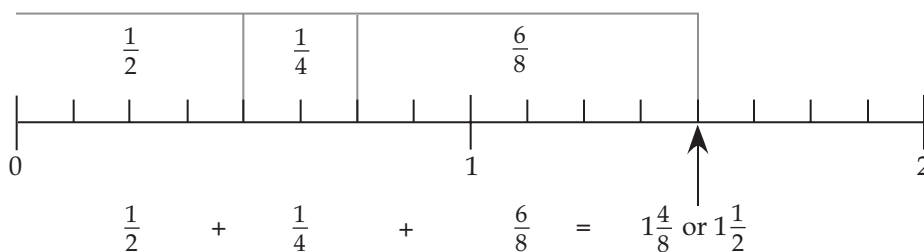
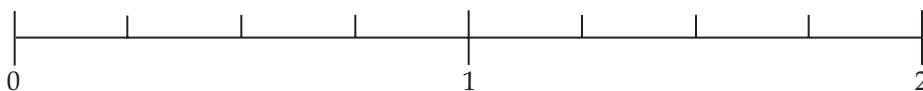

- Students may wish to make their own fraction strip models and number lines using BLM 5–8.12: Fraction Bars.

Developing Algorithms

Allow students to use models as long as they need them. As students model adding and subtracting fractions, and discuss the strategies they use, they will develop algorithms. Multiple models help students to focus on meaning and encourage them to be flexible in their thinking. They provide opportunities to create equivalent fractions and to rename improper fractions and mixed numbers. By using models, students learn that renaming fractions makes statements easier to solve and that the equivalent statements are merely different names for the same action. (As with algorithms for whole-number and decimal operations, introduce algorithms for fractions after students have had time to develop their understanding.)

MATHEMATICAL LANGUAGE

denominator
difference
equivalent fractions
factor, greatest common factor
fraction
improper fraction
mixed number
multiple, least common multiple
numerator
proper fraction
simplify
sum
Venn diagram



Assessing Prior Knowledge

Materials:

- BLM 7.N.5.1: Interpreting and Recording Different Meanings of Fractions
- demonstration board
- marking pens
- projector (optional)
- poster paper (optional)

Organization: Individual or pairs

Procedure:

1. Distribute copies of BLM 7.N.5.1: Interpreting and Recording Different Meanings of Fractions, and have students complete them.
2. Correct the responses together with students, and review various meanings of fractions. During the review, encourage discussion, questions, and additional scenarios, and clear up any misunderstandings. If students have errors on their sheets, have them make changes and add notes with a marking pen. A fraction may represent a “cut” or a part of a whole, a part of a set, a ratio, a portion of a turn, a measurement, a point on a number line, or a division statement.

Variations:

- Vary the complexity of the questions.
- Have students create, model, and name their own situations.
- Have students record representations of stated fractions on paper or at the board.
- Have students create posters or collages to represent various meanings of fractions.
- Use a projector to present visuals of various fractional representations, and have students record matching fraction names.
- Have students create fraction spiders. Draw a circle to represent the spider body and record the name of the fraction on the body. Draw eight legs coming out from the body. At the end of each leg, include some representation of the fraction. The feet may be illustrations, equivalent fractions, equivalent number sentences, word sentences, and so on.

Observation Checklist

- Listen to and observe students' responses to determine whether students can do the following:
 - Interpret and record various meanings of fractions correctly.



Assessing Prior Knowledge

Materials:

- number cubes (10-sided or regular) or spinners
- recording paper
- index cards (optional)
- grid paper and circle templates (optional)

Organization: Whole class, individual, pairs

Procedure:

1. As a class, review definitions of *proper fractions*, *improper fractions*, and *mixed numbers*. Also review procedures for converting improper fractions to mixed numbers, and vice versa.
2. Have students, working individually, roll a number cube or spin a spinner to generate a list of 15 fractions. The first roll or spin determines the numerator and the second roll or spin determines the denominator. Using recording paper, students number and record each fraction neatly in a column, double spacing between fractions. Some fractions will be proper fractions and some will be improper fractions.
3. Have students convert the improper fractions to mixed numbers and record the new names in an adjacent column (about 3 cm away). They may also choose to simplify any fractions not in lowest terms.
4. Students then fold their papers vertically, so that the original fractions are not visible, but the mixed numbers are. They exchange papers with a partner. The partner neatly records the improper fraction equivalents for each mixed number in another column.
5. Students return the papers to the original owners, who compare the responses in all three columns. The partners discuss any discrepancies in the conversions. For example, someone may have simplified or failed to simplify a proper fraction, resulting in a different answer. Discuss the reason for the differences, and whether these differences are really differences in numbers, or in name only.

Variations:

- Have students add one whole to each of the fractions. Record the sum, and repeat the preceding process (e.g., $\frac{6}{4}$ becomes $\frac{10}{4}$, $1\frac{1}{2}$ becomes $2\frac{1}{2}$).
- Have students record the fractions on one face of an index card and use the reverse side to illustrate the fraction and rename it as a mixed number, and perhaps simplify it. Provide students with grid paper and circle templates to ensure their drawings are accurate. Cards can be saved and used for future addition and subtraction learning activities.
- Create a human number line. Ask students to record one of their fractions on paper with large writing. Call small groups to the front of the class. Students in the group hold their fractions in front of their chests, and stand in order from smallest to greatest fraction. Call the next group to fit into the line. Discuss students' strategies for ordering fractions and for what to do with equivalent fractions.

Observation Checklist

- Listen to and observe students' responses to determine whether students can do the following:
 - Correctly convert mixed numbers to improper fractions, and vice versa.
 - Create and identify equivalent fractions.



Assessing Prior Knowledge

Materials:

- BLM 7.N.5.2: Improper Fraction and Mixed Number Cards
- various card sets (for each group) from the following website: Manitoba Education. "Middle Years Activities and Games." *Mathematics*. www.edu.gov.mb.ca/k12/cur/math/my_games/index.html.
- manipulatives (optional)
- grid paper or circle templates (optional)

Organization: Pairs or groups of three

Procedure:

1. Have students form pairs or groups of three to play Concentration.
2. Choose four sets of matching cards (e.g., from BLM 7.4.5.2: Improper Fraction and Mixed Number Cards).
3. Shuffle the cards and arrange them face down in a rectangle.
4. Have players take turns turning over two cards. If the cards represent the same quantity, the players keep the cards. Decide whether a match set warrants another turn.
5. The game ends when all the cards have been matched. The player with the most cards wins.

Variations:

- Students vary the number of card sets, or place the cards face up and match the sets.
- Shuffle a random number of fraction cards and place the pile face down. Players draw a card from the pile and build the fraction using manipulatives, or illustrate that fraction using grid paper or circle templates. They write both the improper fraction and mixed number names for the quantity.

Observation Checklist

- Listen to and observe students' responses to determine whether students can do the following:
 - Correctly convert mixed numbers to improper fractions, and vice versa.



Assessing Prior Knowledge

Materials:

- markers or pens of two different colours (for each pair of students)
- two regular number cubes (providing factors 1 to 12) or a multi-sided number cube (for each pair of students)
- grid paper or tic-tac-toe frames (of various sizes), such as the following:
 - BLM 7.N.3.1A: Tic-Tac-Toe Frames
 - BLM 7.N.3.1B: Tic-Tac-Toe Frames (Medium Challenge)
 - BLM 7.N.3.1C: Tic-Tac-Toe Frame (Ultimate Challenge)
- spinners (optional)

Organization: Pairs

Procedure:

1. Students draw a tic-tac-toe grid and take turns filling in the squares with numbers 1 to 99, or with multiples that correspond to the numbers on their number cube(s).
2. Explain the procedure for this learning activity to students:
 - Students choose a colour and an X or an O mark, and determine who will play first.
 - Students take turns rolling the number cube(s), and use their colour marker to mark an X or an O on a multiple of the number they rolled. Encourage them to practise using mathematical language with statements such as the following:
 - 27 is a multiple of 9 because $3 \times 9 = 27$.
 - 9 and 3 are factors of 27 because $3 \times 9 = 27$.
 - 17 is a prime number. Its only factors are 1 and 17.
 - Students will need to agree about what to do if someone makes an error. They may lose a turn, forfeit their play to their opponent, or just accept the correction.
 - The first student who creates a horizontal, vertical, or diagonal line with his or her marks wins.

Variations:

- Extend the grid to 4×4 or 5×5 , or whatever dimensions students are able to handle.
- Vary the shape or size of the winning line.
- Include multiples of 12, 15, and 25, or target specific factors with custom-labelled number cubes or spinners.
- Prepare boards with selected numbers for students to practise.
- Encourage students to practise strategies when selecting their multiples.

Observation Checklist

- Listen to and observe students' responses to determine whether students can do the following:
 - Use vocabulary for multiples, factors, and prime numbers correctly.
 - Identify multiples of various numbers correctly.
 - Identify prime numbers correctly.

Suggestions for Instruction

- **Simplify a positive fraction or mixed number by identifying the common factor between the numerator and denominator.**

Materials:

- BLM 7.N.3.2: Equivalent Fraction Challenge
- a pair of six-sided number cubes, or a multi-sided cube, or a spinner (for each pair of students)
- calculators or multiplication charts (optional)

Organization: Whole class, pairs

Procedure:

1. As a class, review procedures for creating equivalent fractions by multiplying or dividing by a fraction name for 1, or by multiplying or dividing each term in the fraction by the same factor.

2. Demonstrate one round of the game, following the procedures outlined on BLM 7.N.3.2: Equivalent Fraction Challenge, and using the game cards provided on the BLM. In summary, students create a target fraction, take turns rolling the number cube(s) to determine a change factor, and then create an equivalent fraction. The player who returns the fraction to its original target name wins.
3. Distribute game cards.
4. Have students play the game in pairs.

Variations:

- Vary the complexity of the arithmetic by controlling the options on the type of number cubes. Use basic six-sided number cubes for numbers 1 to 6, a pair of number cubes for numbers 1 to 12, custom-labelled number cubes, or multi-sided number cubes. If you use a number cube with a zero, make a rule pertaining to zero (e.g., the player who rolls zero forfeits his or her turn, or forfeits the game). A spinner may also be used.
- Allow students who have difficulty with multiplication and division facts to use a calculator, a multiplication chart, or some other aid. Continue to work on developing students' understanding of multiplication and division facts so that they may develop recall.
- The game could be played with larger groups, or as a class.



Observation Checklist

- Listen to and observe students' responses to determine whether students can do the following:
 - Create equivalent fractions correctly and simplify fractions with ease.
 - Use mathematical language to communicate about fractions.

Suggestions for Instruction

- **Simplify a positive fraction or mixed number by identifying the common factor between the numerator and denominator.**

Materials:

- presentation board
- math journals or notebooks

Organization: Whole class, individual

Procedure:

1. Present the class with a fraction that can be easily simplified (e.g., $\frac{2}{4}$, $\frac{2}{6}$, $\frac{6}{8}$). Record the fraction on the board, ask for its simplified form, and record that fraction on the board. Continue recording and simplifying fractions, increasing the demand of the task. Ask students to explain the reasons behind their simplifications, and ask whether the new fractions can be simplified further. Eventually, it should become evident that it would be desirable to have a reliable, simple procedure to simplify less obvious fractions (e.g., $\frac{24}{36}$, $\frac{14}{63}$).
2. Solicit fraction suggestions from students. Someone may suggest that if you knew the largest factor of both numbers, you would need to divide each number only once. Tell students this strategy is called *finding the greatest common factor*.
3. Write a fraction (e.g., $\frac{24}{36}$) on the board. List the numerator and the denominator, and ask students to identify the factors for each number in a systematic progression.

Example:

Begin with the smallest factor of 24 (which is 2) and record it toward the left end of the row. Record its corresponding factor (12) toward the right end of the row. Continue working toward the centre until both factors begin to repeat.

$$\begin{array}{l} 24: (2, (3, (4, (6, 8, (12 \\ 36: (2, (3, (4, (6, 9, (12, 18 \end{array}$$

Look for the largest factor that is common to both numbers. In this case, the largest factor is 12. Use this factor to simplify the fraction by dividing by $\frac{12}{12}$ as a name for 1. Or divide both the numerator and the denominator by 12.

$$\frac{24}{36} \div \frac{12}{12} = \frac{2}{3}$$

4. Have students generate a list of obvious and less obvious fractions for which they will find the greatest common factor, and which they will simplify. Include proper fractions, improper fractions, and mixed numbers.
5. Record the list of fractions on the board, and have students record it in their math journals or notebooks. Complete one more sample together with the class, and then have students find the factors and simplify the fractions on their own. When they have completed the task, correct responses as a class. Solicit questions and comments, and have students record corrections and notes in their math journals or notebooks.

Variation:

- Supply students with a sheet containing a collection of fractions and proper, improper, and mixed numbers. Students list the factors for the numerator and the denominator, indicate the greatest common factor, and simplify the fraction.



Observation Checklist

- Listen to and observe students' responses to determine whether students can do the following:
 - Simplify a positive fraction or mixed number by identifying the common factor between the numerator and denominator.

Suggestions for Instruction

- **Model addition and subtraction of positive fractions or mixed numbers using concrete representations, and record symbolically.**
- **Determine a common denominator for a set of positive fractions or mixed numbers.**

Materials:

- presentation board
- math journals or notebooks
- rulers
- pens or markers of different colours
- manipulatives to represent fractions (e.g., pattern blocks, fraction circles, Cuisenaire rods, grids, counters)
- templates copied on card stock (e.g., fraction bars, circles, pattern blocks, rods, grid paper) for students to copy or cut and glue into their math notebooks
- scissors, glue (optional)

Organization: Small groups, whole class, individual

Procedure:

Part A: Modelling Fractions Equalling a Whole

1. Have students, working in small groups, use different types of manipulatives to explore different ways to represent a whole. Consider giving each group different types of manipulatives, depending on the number of resources available. Decide whether to include only manipulatives that represent the “cut” (part of a whole) meaning of a fraction, or whether to include a point on a line. Have students talk about their models within their groups, and draw illustrations (or cut and paste templates) of two or more models in their math journals or notebooks.
2. Have students reassemble as a class. Ask a few students to share their models with the class. Show their illustrations on the presentation board.
3. Solicit ideas from students about how to write an addition statement to match each model of fractions equalling a whole.

Example:

Here is one example using pattern blocks:

- A hexagon can represent one whole.
- Three rhombuses cover the hexagon and occupy the same space, so each rhombus represents $\frac{1}{3}$ of the whole.

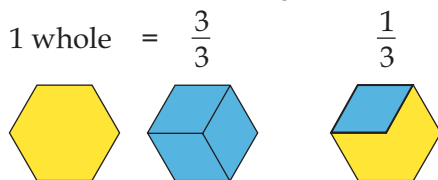

$$\frac{1}{3} + \frac{1}{3} + \frac{1}{3} = 1 \text{ or } \frac{3}{3}$$

- Combine fractional pieces if you wish. (See Concepts to Review during Discussion, following Parts A to C of the procedures.)

$$\frac{1}{3} + \frac{1}{3} = \frac{2}{3} \text{ and } \frac{2}{3} + \frac{1}{3} = \frac{3}{3} \text{ and } \frac{3}{3} = 1$$

- Subtraction can be represented with the same model.
- Demonstrate a take-away action. Also, remove a fractional part and find the difference by comparing what is left of the whole. Ask what part is missing.

- Write the matching subtraction statements:

$$1 \text{ or } \frac{3}{3} - \frac{1}{3} = \frac{2}{3}$$

- Take away some more if you wish:

$$\frac{2}{3} - \frac{1}{3} = \frac{1}{3}$$

- Find the difference between two of the fractional parts:

$$\frac{1}{3} - \frac{1}{3} = 0$$

- When the appropriate model arises, extend the example to the following:

$$\frac{1}{3} - \frac{1}{6} = \frac{1}{6}$$

4. Have students return to their math journals or notebooks and write addition and subtraction statements to match the models they illustrated.

Part B: Modelling Fractions, Including Proper Fractions

5. Have the groups change manipulatives and repeat the process outlined in Part A as many times as seems useful. If students are ready, have them consider equivalent representations, simplified fractions, and statements involving proper fractions less than a whole. Remind students to talk with their groups about their models and the matching of addition and subtraction statements. Have students record two or more new models, and write matching addition and subtraction statements.
6. Have students reassemble as a class to share interesting discoveries and to verify responses.

Part C: Modelling Proper Fractions, Improper Fractions, and Mixed Numbers

7. When appropriate, invite students to include combinations that represent more or less than a whole (e.g., mixed numbers such as $1\frac{3}{8}$ pizzas, $2\frac{1}{2}$ cans of juice, $\frac{3}{4}$ of a chocolate bar, $\frac{5}{8}$ of an inch). Remind students to verify that the fractional pieces are equal parts of the particular whole. Identifying the whole is important to understanding the fractional relations. Have students talk about their models and statements within their groups. Remind them to draw illustrations (or cut and paste templates) of two or more of the models in their math journals or notebooks.
8. Reassemble as a class, and have a few students share their new models and addition or subtraction statements. This sharing process provides both you and the students with an opportunity to verify responses. When modelling subtraction, compare two fractions and find the difference or missing part between them. Also model subtraction as taking away a fractional part from a mixed number. Have students write or verify their addition and subtraction statements for the models.

9. Have the groups change manipulatives and repeat the process as many times as seems useful. Have students discuss their models and statements within their groups, and record two or more models and matching addition and subtraction statements.

Concepts to Review during Discussion

- A. The fraction models provide opportunities for rewriting addition and subtraction statements by combining fractions with like denominators, and renaming unlike denominators with equivalent fractions to obtain common denominators.
- B. As you write equations for the models, discuss with students why these fractions with different names can be combined. The $\frac{1}{3}$ sections represent three equal parts of a whole, and the $\frac{1}{6}$ sections represent six equal parts of the same whole. They are all parts of the same whole.
- C. Not all fraction sizes of the same whole can be combined to equal one whole. For example, combining halves and fifths will always result in either more or less than a whole.
- D. The same fraction name can be used to represent different quantities. For example, $\frac{1}{2}$ of the water in my glass is different than $\frac{1}{2}$ of the water in my bathtub. Furthermore, $\frac{1}{3}$ of my whole pattern block is not the same as $\frac{1}{3}$ of your Cuisenaire rod, nor the same as $\frac{1}{3}$ of someone's fraction block. When using a "cut" (part of a whole) meaning of a fraction, the parts must be a fraction of the same whole in order to combine them. Revisit this topic frequently when discussing combining different types of fractions. When using Cuisenaire rods, students can explore to find that the red 2 cm blocks represents $\frac{1}{4}$ of the brown 8 cm rod, or $\frac{1}{5}$ of the orange 10 cm rod, but it represents neither $\frac{1}{4}$ nor $\frac{1}{5}$ of the blue 9 cm rod.
- E. If a fraction represents a division situation, then it is a name for a number in our number system. It represents a portion of one unit. For example, $\frac{4}{2}$ represents $4 \div 2$, or the number 2, which is two whole units, and $\frac{1}{2}$ represents one divided by 2, $\frac{1}{2}$, or 0.5. If the fractions represent numbers, then any fractions can be combined, because they all represent parts of the same whole number unit, and not parts of different wholes, regions, or sets. When fractions are presented without a stated context, they represent this name for a number meaning, and can be added or subtracted freely. Fraction strips are a convenient representation of this concept. (See the next learning activity.)

Variations:

- For more direct instruction, guide students through specific models and matching addition and subtraction sentences.
- Provide scaffolding by supplying students with templates to complete.



Observation Checklist

- Listen to and observe students' responses to determine whether students can do the following:
 - Model addition and subtraction of positive fractions or mixed numbers using concrete representations, and record symbolically.

Suggestions for Instruction

- **Model addition and subtraction of positive fractions or mixed numbers using concrete representations, and record symbolically.**

Materials:

- BLM 5–8.12: Fraction Bars (copied on heavy paper or card stock)
- prepared sample of fraction strips and matching number lines
- scissors
- resealable bags for storing pieces
- math journals or notebooks
- magnetic tape (optional)

Organization: Whole class, individual

Procedure:

1. Demonstrate how fraction strips can serve as convenient models, as there are multiple fraction sizes for the same size of a whole. They can be used to find equivalent fractions.
2. Fraction strips are useful models for representing fractions as numbers because they are parts of the unit number 1. They represent fractions as points on a number line, and can be joined together on the coordinating number line to match fraction combinations with corresponding sums or differences. Demonstrate how to use the model.

3. Provide students with card stock copies of BLM 5–8.12: Fraction Bars. Have students make a set of fraction strips and corresponding number lines to use in various learning activities. Store the products in resealable bags.
4. Have students generate a list of addition and subtraction questions, and ask them to use their models to write several addition and subtraction statements, recording them in their math journals or notebooks.

Variations:

- Fasten the fraction strips to magnetic tape before cutting them. This adds greater durability, and the strips can be stored and used on a magnetic surface to minimize difficulty managing so many loose pieces.
- Prepare a list of addition and subtraction statements for students to practise using the fraction strips.



Observation Checklist

- Listen to and observe students' responses to determine whether students can do the following:
 - Model addition and subtraction of positive fractions or mixed numbers using concrete representations, and record symbolically.
 - Use models to aid in the visualization of adding and subtracting with fractions.

Suggestions for Instruction

- **Model addition and subtraction of positive fractions or mixed numbers using concrete representations, and record symbolically.**
- **Determine the sum of two positive fractions or mixed numbers with like denominators.**
- **Determine a common denominator for a set of positive fractions or mixed numbers.**
- **Determine the sum of two positive fractions or mixed numbers with unlike denominators.**
- **Simplify the solution to a problem involving the sum or difference of two positive fractions or mixed numbers.**
- **Solve a problem involving the addition or subtraction of positive fractions or mixed numbers, and determine if the solution is reasonable.**

Materials:

- BLM 7.N.5.3A: Ace Aviation: Adding Fractions
- BLM 7.N.5.4A: Representing Recognizable Fractions and Writing Addition Statements (optional)
- presentation board
- manipulatives to represent fractions (e.g., BLM 5–8.12: Fraction Bars, pattern blocks, fraction circles, Cuisenaire rods, grids, counters)
- fraction strips and number lines (made by students)
- a reference list or a handout of model illustrations, scenarios, and problems involving adding and subtracting fractions (optional)
- index cards (optional)

Organization: Small groups, whole class, individual

Procedure:

1. Provide students with copies of BLM 7.N.5.3A: Ace Aviation: Adding Fractions, and have them respond to questions 1 to 4.
2. Discuss students' responses to questions 1 to 3.
3. Discuss students' thinking regarding the addition in question 4. Include the following ideas:
 - Discuss the models students used to combine the tourists and the vacationers with those visiting family or friends $\left(\frac{1}{3} + \frac{1}{6}\right)$. These numbers can be added together, because each fraction represents parts of the same whole. That whole is all the airline passengers. The principles of adding apply.
 - Discuss the benefits of making an estimate before adding the fractions. The estimate helps establish a target zone for the solution, and verifies whether or

not the answer is reasonable. Benchmarks of close to, more or less than, 0, $\frac{1}{2}$, or wholes are helpful. Students may use their model of a whole, or a number line, as a reference point for benchmarks (e.g., $\frac{1}{3}$ is less than $\frac{1}{2}$, and $\frac{1}{6}$ is a little more than 0, and together they must be close to $\frac{1}{2}$).

- In the models (for $\frac{1}{3} + \frac{1}{6}$), it is evident the pieces cover $\frac{1}{2}$ of the whole, but how to count these pieces to equal $\frac{1}{2}$ is not as clear. As in combining any measure, before we count, the pieces must all have the same unit of measure. When counting fractions, converting the units to the same measure is called *finding a common denominator*. For example, $\frac{1}{3}$ is equivalent to $\frac{2}{6}$, $\frac{2}{6} + \frac{1}{6} = \frac{3}{6}$, and $\frac{3}{6}$ is equivalent to $\frac{1}{2}$. To represent this conversion with a concrete model, replace the $\frac{1}{3}$ piece with two $\frac{1}{6}$ pieces, and then replace the three $\frac{1}{6}$ pieces with a $\frac{1}{2}$ piece. The parts are different names for the same numbers. Model writing the addition statements with the conversions.
 - Ensure students are comfortable with these concepts. If the numbers represent different types of parts, such as $\frac{1}{3}$ of the passengers and $\frac{1}{6}$ of the crew, they cannot be added together, because they are parts of different wholes. See Conceptual Understandings in the Background Information for learning outcome 7.N.5.
4. Have students represent the addition of other recognizable fractions and write representative addition statements. Include improper fractions and mixed numbers. Discuss how to rename the resulting improper fractions as mixed numbers. Solicit the addends from the class, or have a list prepared as a handout, such as BLM 7.N.5.4A: Representing Recognizable Fractions and Writing Addition Statements.

Variations:

- Have students invent a passenger survey for a different airline, or prepare data for other scenarios, and write questions and answers based on their data.
- Supply students with a number of scenarios requiring them to find the total. Use friendly fractions and include mixed numbers and improper fractions.
- Have students generate a number of scenarios requiring adding friendly fractions, including mixed numbers and improper fractions. Have them find the sums. These can be recorded on index cards, with the scenario on one side and the answer on the reverse. The cards can be used later for review and drill exercises.



Observation Checklist

- Listen to and observe students' responses to determine whether students can do the following:
 - Model addition and subtraction of positive fractions or mixed numbers using concrete representations, and record symbolically.
 - Determine the sum of two positive fractions or mixed numbers with like denominators.
 - Determine a common denominator for a set of positive fractions or mixed numbers.
 - Determine the sum of two positive fractions or mixed numbers with unlike denominators.
 - Simplify the solution to a problem involving the sum or difference of two positive fractions or mixed numbers.
 - Solve a problem involving the addition or subtraction of positive fractions or mixed numbers, and determine if the solution is reasonable.

Suggestions for Instruction

- **Model addition and subtraction of positive fractions or mixed numbers using concrete representations, and record symbolically.**
- **Determine the sum of two positive fractions or mixed numbers with like denominators.**
- **Determine the difference of two positive fractions or mixed numbers with like denominators.**
- **Determine a common denominator for a set of positive fractions or mixed numbers.**
- **Determine the sum of two positive fractions or mixed numbers with unlike denominators.**
- **Determine the difference of two positive fractions or mixed numbers with unlike denominators.**
- **Simplify the solution to a problem involving the sum or difference of two positive fractions or mixed numbers.**
- **Solve a problem involving the addition or subtraction of positive fractions or mixed numbers, and determine if the solution is reasonable.**

Materials:

- BLM 7.N.5.3B: Ace Aviation: Subtracting Fractions
- BLM 7.N.5.4B: Representing Recognizable Fractions and Writing Subtraction Statements (optional)
- BLM 7.N.5.5: Adding and Subtracting Fractions (Scenarios) (optional)
- presentation board
- manipulatives to represent fractions (e.g., BLM 5–8.12: Fraction Bars, pattern blocks, fraction circles, Cuisenaire rods, grids, counters)
- fraction strips and number lines (made by students)
- math journals or notebooks
- a reference list or a handout of model illustrations, scenarios, and problems involving adding and subtracting fractions (optional)
- index cards (optional)

Organization: Small groups, whole class, individual

Procedure:

1. Provide students with copies of BLM 7.N.5.3B: Ace Aviation: Subtracting Fractions, and have them respond to questions 1 to 4.
2. Have students share their responses to the subtraction questions. Examine students' models for representing removing the business travellers.
3. Model different subtraction scenarios using number lines and fraction strips.

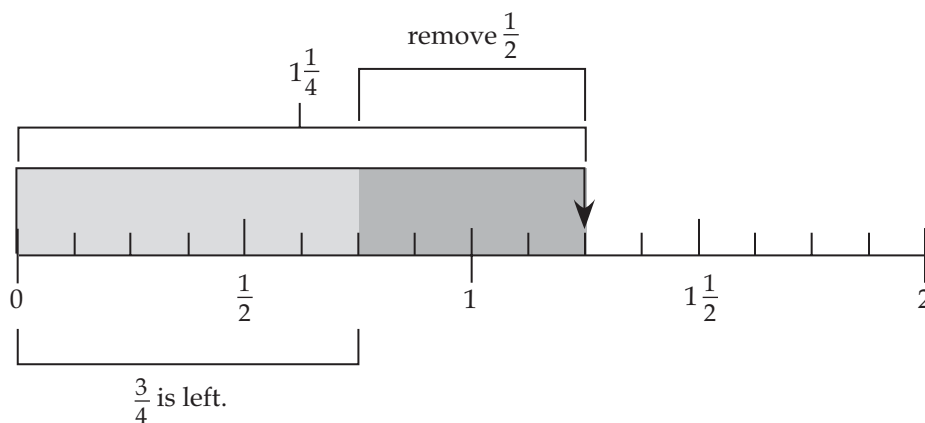

4. Have students make any necessary revisions to their work, or add any notes they consider useful.

5. Once again, discuss the benefits of making an estimate before subtracting the fractions. The estimate helps establish a target zone for the solution, and verifies whether or not the answer is reasonable. Benchmarks of close to, more or less than, 0, $\frac{1}{2}$, or wholes are helpful. Students may use their model of a whole, or a number line, as a reference point for benchmarks.
6. Have students model and record subtraction of other recognizable fractions and mixed numbers, such as those on BLM 7.N.5.4B: Representing Recognizable Fractions and Writing Subtraction Statements.
7. Ask students to create scenarios to match the fractions. Have them write subtraction statements for each model. Ensure they understand that the fractional part must be equal to or less than the fractional part it is being taken away from. Solicit and reinforce ideas about borrowing from the wholes and cutting up the new piece to form an improper fraction from which to subtract. Include related addition statements if you wish.
8. Reassemble as a class and have students present a few models and subtraction statements to ensure everyone is on the right track. Present models and subtraction scenarios, and ask students to write subtraction statements to represent the models and scenarios, recording them in their math journals or notebooks. Include related addition statements if you wish. Discuss the responses.
9. Have students complete a selection of addition and subtraction problems and arithmetic questions. Include improper fractions and mixed numbers in the problems and questions. Solicit the addends from the class, or have a list prepared on a handout, such as those presented on BLM 7.N.5.5: Adding and Subtracting Fractions (Scenarios).

Variations:

- Have students invent a passenger survey for a different airline, or prepare data for other scenarios, and write questions and answers based on their data.
- Supply students with a number of scenarios requiring them to find the total or the difference. Use friendly fractions and include mixed numbers and improper fractions.
- Have students generate a number of scenarios requiring adding or subtracting friendly fractions, including mixed numbers and improper fractions. Have them find the sums and differences. These can be recorded on index cards, with the scenario on one side and the answer on the reverse. The cards can be used later for review and practice exercises.



Observation Checklist

- Listen to and observe students' responses to determine whether students can do the following:
 - Model addition and subtraction of positive fractions or mixed numbers using concrete representations, and record symbolically.
 - Determine the sum of two positive fractions or mixed numbers with like denominators.
 - Determine the difference of two positive fractions or mixed numbers with like denominators.
 - Determine a common denominator for a set of positive fractions or mixed numbers.
 - Determine the sum of two positive fractions or mixed numbers with unlike denominators.
 - Determine the difference of two positive fractions or mixed numbers with unlike denominators.
 - Simplify the solution to a problem involving the sum or difference of two positive fractions or mixed numbers.
 - Solve a problem involving the addition or subtraction of positive fractions or mixed numbers, and determine if the solution is reasonable.

Suggestions for Instruction

- **Determine a common denominator for a set of positive fractions or mixed numbers.**

Materials:

- manipulatives
- presentation board
- a list of fractions for students to add and subtract, some with obvious solutions and some with solutions that require finding common denominators
- grids and counters (optional)
- paper, markers, and other art supplies (for making posters or brochures)

Organization: Whole class, individual

Procedure:

1. Present students with sets of fractions to add and subtract. Ask them what makes some types of questions involving fractions easier to answer than other types. The questions that have friendly fractions with common denominators, or fraction sizes that relate easily to each other, are easier to model and to solve. If the more difficult questions could be renamed to have common denominators, they would be easier to answer.
2. Ask students to explore finding a way to rename fractions with common denominators. *Finding a common denominator* is the term used for converting fractions to common units. Students may use grids and counters (as explained in the Background Information for learning outcome 7.N.5), or generate a list of equivalent fractions, and look for a pattern. All denominators in the equivalent fractions are multiples of the original denominators. Therefore, the common denominator must be a multiple of both the original denominators. Students can use their prior knowledge of finding multiples and the lowest common multiple, and their ability to simplify fractions, to develop a strategy to find common denominators.

Extension:

- Have students generate a list of the best hints and strategies for adding and subtracting fractions, and present them as small posters or brochures.

Variations:

- Guide students through a series of steps to find common denominators.
- Provide students with handouts containing sets of fractions. Have students show how they generated a common denominator for the set, and how they renamed the fractions.

**Observation Checklist**

- Listen to and observe students' responses to determine whether students can do the following:
 - Determine a common denominator for a set of positive fractions or mixed numbers.
 - Make connections between determining a common denominator and their prior knowledge regarding factors and multiples.

Suggestions for Instruction

- **Simplify the solution to a problem involving the sum or difference of two positive fractions or mixed numbers.**
- **Solve a problem involving the addition or subtraction of positive fractions or mixed numbers, and determine if the solution is reasonable.**

Materials:

- BLM 7.N.5.6: Problems Involving Fractions (or other sample fraction problems)
- marking pens

Organization: Individual, whole class

Procedure:

1. Distribute copies of BLM 7.N.5.6: Problems Involving Fractions or other fraction problems.
2. Ask students to solve the problems, provide estimates, and simplify answers.
3. After students have had sufficient time to complete the tasks, discuss their solutions to the problems.
4. Have students use a marking pen to make any necessary corrections or add any notes to their work.

Variation:

- Have students set criteria for problems involving fractions, and ask them to create a set number of problems and an answer key. Photocopy their problem sheets. Students trade sheets, solve the problems, and then reassemble as a group and review the solutions together.



Observation Checklist

- Listen to and observe students' responses to determine whether students can do the following:
 - Simplify the solution to a problem involving the sum or difference of two positive fractions or mixed numbers.
 - Solve a problem involving the addition or subtraction of positive fractions or mixed numbers, and determine if the solution is reasonable.

NOTES

Number (7.N.6)

Enduring Understanding(s):

The principles of operations used with whole numbers also apply to operations with decimals, fractions, and integers.

Number sense and mental mathematics strategies are used to estimate answers and lead to flexible thinking.

General Learning Outcome(s):

Develop number sense.

SPECIFIC LEARNING OUTCOME(S):	ACHIEVEMENT INDICATORS:
<p>7.N.6 Demonstrate an understanding of addition and subtraction of integers, concretely, pictorially, and symbolically. [C, CN, PS, R, V]</p>	<ul style="list-style-type: none">→ Explain, using concrete materials such as integer tiles and diagrams, that the sum of opposite integers is equal to zero.→ Illustrate, using a horizontal or vertical number line, the results of adding or subtracting negative and positive integers (e.g., a move in one direction followed by an equivalent move in the opposite direction results in no net change in position).→ Add two integers using concrete materials or pictorial representations, and record the process symbolically.→ Subtract two integers using concrete materials or pictorial representations, and record the process symbolically.→ Solve a problem involving the addition and subtraction of integers.

PRIOR KNOWLEDGE

Students may have had experience with the following:

- Demonstrating an understanding of addition of numbers with answers to 10 000 and their corresponding subtractions (limited to 3- and 4-digit numerals) by
 - using personal strategies for adding and subtracting
 - estimating sums and differences
 - solving problems involving addition and subtraction
- Describing and applying mental mathematics strategies, such as
 - skip-counting from a known fact
 - using doubling or halving
 - using doubling and adding one more group
 - using patterns in the 9s facts
 - using repeated doublingto develop recall of basic multiplication facts to 9×9 and related division facts.
- Applying estimation strategies including
 - front-end rounding
 - compensation
 - compatible numbersin problem-solving contexts.
- Demonstrating an understanding of integers, concretely, pictorially, and symbolically.

For more information on prior knowledge, refer to the following resource:

Manitoba Education and Advanced Learning. *Glance Across the Grades: Kindergarten to Grade 9 Mathematics*. Winnipeg, MB: Manitoba Education and Advanced Learning, 2015. Available online at www.edu.gov.mb.ca/k12/cur/math/glance_k-9/index.html.

RELATED KNOWLEDGE

Students should be introduced to the following:

- Demonstrating an understanding of oral and written patterns and their corresponding relations.
- Constructing a table of values from a relation, graphing the table of values, and analyzing the graph to draw conclusions and solve problems.
- Demonstrating an understanding of preservation of equality by
 - modelling preservation of equality, concretely, pictorially, and symbolically
 - applying preservation of equality to solve equations

- Evaluating an expression, given the value of the variable(s).
- Modelling and solving problems that can be represented by one-step linear equations of the form $x + a = b$, concretely, pictorially, and symbolically, where a and b are integers.
- Demonstrating an understanding of central tendency and range by
 - determining the measures of central tendency (mean, median, mode) and range
 - determining the most appropriate measures of central tendency to report findings
- Determining the effect on the mean, median, and mode when an outlier is included in a data set.

BACKGROUND INFORMATION

Integers: Definition and Notation

Integers are the set of numbers consisting of the natural numbers (1, 2, 3, . . .), their opposites (-1, -2, -3, . . .), and zero. They are also referred to as the *whole numbers* and their opposites.

Integers indicate both a quantity and a direction from zero. Positive integers are greater than zero. They are represented by a positive symbol (+) before the integer, such as (+5). Negative integers are less than zero. They are represented by a negative symbol (-) before the integer, such as (-3). There are two common notations for integers. The symbols are written either as superscripts preceding the integer, as in ${}^+5$, ${}^-3$, or the symbol and the integer are both enclosed within parentheses, as in (+5), (-3). The parentheses are commonly used in student materials to avoid any confusion between the integer sign and the notations for addition and subtraction. In the equation $(+5) - (-3) = (+8)$, the parentheses indicate the numbers inside are integers and distinguish the integer symbols from the subtraction symbol.

Integer Use

Understanding and working with integers is important in daily life. Integers are regularly encountered in contexts such as finances, investments, temperatures, elevations, time relevant to events, and sports. Proficiency with adding and subtracting integers will be important in students' future algebra work, and is a useful mental mathematics strategy for multi-digit subtraction. Knowledge of integers provides a language for students to express their thinking when they use numbers less than zero.

Example:

To subtract $526 - 379$,

Think: $(500 - 300) + (20 - 70) + (6 - 9)$

$(+200) + (-50) + (-3)$

$(+150) + (-3)$

Equals: $(+147)$

Representing Integer Operations with Models

In Grade 7, students extend their understanding of integers acquired in Grade 6 as they learn to add and subtract positive and negative numbers. Provide students with many opportunities to represent integers (concretely, pictorially, and symbolically) to develop their understanding. Encouraging students to use a variety of manipulatives and strategies will help them to develop confidence in determining and applying general rules for both adding and subtracting integers.

Concrete Models

Concrete models include the following:

1. **Algebra tiles:** One face of an algebra tile is one colour, and the opposite side is a different colour. Use one side to represent positive integers, and the reverse side to represent negative integers.
2. **Sets of counters in two different colours:** Choose one colour to represent positive integers, and the other to represent negative integers. Matching sets of both colours represent zero. For example, blue chips represent negative integers, while red chips represent positive integers. To solve the problem of $(+3) + (-7)$, set out three red chips and seven blue ones. Physically match up pairs of red and blue chips to equate them to zero, and remove the remaining chips. The remaining four blue chips represent the solution, (-4) .
3. **Computer models:** Many computer simulations allow students to pull the representative positive and negative counters into a collection bin. Students match opposite representations to represent zero, and the counters disappear. The answer remains in the bin to be counted.

Sample Website:

For an example of a computer model, refer to the following website:

Utah State University. "Number and Operations (Grades 3–5)."

National Library of Virtual Manipulatives. 1999–2010.

http://nlvm.usu.edu/en/nav/category_g_2_t_1.html.

Select Color Chips—Addition or Color Chips—Subtraction from the list of virtual manipulatives provided.

4. **Number lines:** A thermometer is a natural number line, and can be viewed vertically or horizontally. The distance of an integer from zero represents the quantity of the integer, and the direction from zero represents whether the integer is positive or negative.
 - On a *vertical number line*, the distance above zero represents positive integers. Distances below zero represent negative integers. Values always increase up the line, and decrease down the line.

- On a *horizontal number line*, positive integers are represented to the right of zero, and negative integers are represented to the left of zero. Values always increase from left to right, and decrease from right to left.
- An integer's quantity may also be represented with vector models or the length of an arrow from zero to the integer.
 - An arrow pointing to the right indicates a positive value, and an arrow to the left indicates a negative value. The length of the combined arrows indicates the combined value. These arrows are typically placed end to end.

Example:

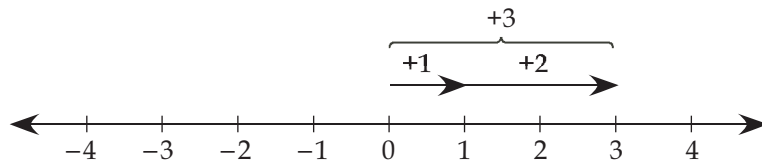

- Arrows pointing in opposite directions are laid on top of (on a horizontal number line) or beside (on a vertical number line) each other. The beginning of one arrow is matched with the end of the other arrow.

Example:

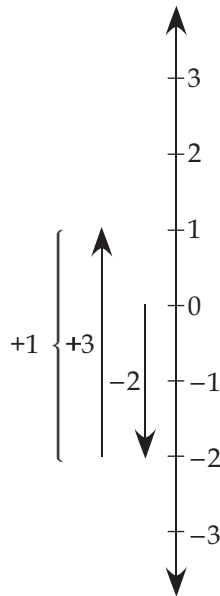

- The combination of integers may also be represented by jumps on a number line. Jumps to the right represent addition, and jumps to the left represent subtraction. A negative integer moves in the opposite direction. Use both vertical and horizontal number lines to represent changes in temperatures, elevations, and distances travelled.

Generalizations about Integers

As students work with different manipulatives and use different strategies, they will likely come to the following generalizations about integers. Rather than explicitly teaching the generalizations as rules, provide students with opportunities to discover these generalizations.

The Zero Principle

- The sum of opposite integers (sometimes called the zero pairs) is always zero.
- Adding equal positive and negative numbers to a quantity does not change the net value of the quantity.

Adding Integers

- The sum of two positive integers is always positive (e.g., $(+2) + (+3) = (+5)$).
- The sum of two negative integers is always negative (e.g., $(-2) + (-3) = (-5)$).
- The sum of one negative integer and one positive integer may be either negative or positive, depending on the sign of the number that is farthest from zero (i.e., subtract the absolute values of the integers and use the sign of the integer with the greater absolute value) (e.g., $(+2) + (-3) = (-1)$).

Subtracting Integers

- Subtracting an integer is equivalent to adding its opposite (e.g., $(+4) - (-2) = (+4) + (+2) = (+6)$).
- If both integers have the same sign and the minuend is further away from zero than the subtrahend, find the difference and keep the sign (e.g., $(+7) - (+3) = (+4)$ or $(-7) - (-3) = (-4)$).
- If both integers have the same sign and the subtrahend is further away from zero than the minuend, find the difference and use the opposite sign (e.g., $(+2) - (+6) = (-4)$ or $(-2) - (-6) = (+4)$). (Equivalent to adding the opposite.)
- If the signs are different, add the values and use the sign of the minuend (e.g., $(-5) - (+3) = (-8)$ or $(+3) - (-5) = (+8)$). (Equivalent to adding the opposite.)

MATHEMATICAL LANGUAGE

absolute value*

integer

minuend

negative integer

positive integer

sign

subtrahend

zero principle

*** Note:**

Teachers may model correct use of absolute value, but it is not an expectation for Grade 7 students.



Assessing Prior Knowledge

Materials:

- research resources, such as
 - magazines, newspapers, pamphlets
 - almanacs
 - online databases
 - Statistics Canada. www.statcan.gc.ca/.
- scissors, glue, markers, and poster board (for making posters)

Organization: Whole class, small groups

Procedure:

1. As a class, brainstorm contexts in which integers are used in daily life. Situations may include the following:
 - depths/levels of oceans, lakes, and rivers
 - levels of tides, mountains, and cities
 - levels of tall buildings, underground parking garages, and mine shafts
 - temperatures
 - finances, savings and spending, loans and debts
 - value of investments (e.g., share prices, stocks, mutual funds)
 - sports and player statistics
2. Divide the class into small groups, and have each group research and compare statistics related to a selected theme. Themes may include elevations of various cities or mountains, depths of lakes or oceans, river levels in times of flood and drought, temperature extremes in various cities, and player statistics in various sports leagues (e.g., +/- differentials in hockey, and par in golf).
3. Each group then finds a creative way to present their research findings in a collage or on a poster with appropriate titles. For example, students may create an illustration of cities in order of lowest to highest elevation, or coldest to warmest cities, or highest and lowest point on each continent, or worst to best performing stocks for a given period, or the performance of sports teams or players.

Variation:

- Each group has a general thematic focus. Students cut out headlines, diagrams, charts, graphs, and illustrations of contexts in which integers are represented in daily life, and use the clippings to create a collage. They add appropriate headings.

Observation Checklist

- Listen to and observe students' responses to determine whether students can do the following:
 - Describe contexts in which integers are used.
 - Order integers correctly.

**Assessing Prior Knowledge****Materials:**

- paper and pens or demonstration board (to keep track of points)
- space for each pair of teams to use as a pitching mound, home plate, and bases

Organization: One to four teams, depending on class size

Procedure:

1. Have students form teams to play integer baseball.
2. Choose one team to bat, one team to pitch, and a scorekeeper.
3. Each team lines up at the home plate or on the pitching mound.
4. The first pitcher "pitches" to the first batter a situation or an action phrase that may be represented by an integer.
5. The batter replies with the representative integer. The waiting pitchers determine whether the answer is correct. If the batter is correct, he or she has a "hit," and begins rotating through the bases. An error counts as an "out." The bases are cleared, and the players return to the end of the batting line.
6. The previous pitcher goes to the end of the pitching line, and the next pitcher pitches a new situation, and play continues.
7. When a player returns to home plate, a "run" is scored. At three "outs," the teams switch places.

8. Suggested rules:

- No situations may be repeated.
- Pitchers and batters must respond within five seconds.
- No players can steal bases; they must be “hit” to the next base.
- If the pitchers make an error in judgment, the batting team scores a “home run,” and any players on bases are “hit” home, each scoring a run.

Variations:

- Have small teams or pairs sit in groups and rotate bases on a paper “field.”
- Switch or vary the actions. Pitchers pitch integers, and batters describe a matching contextual situation.
- Supply a list of situations for pitchers to use.
- Use paper-and-pencil or student-generated tasks requiring students to write the integer that matches a situation and/or describe a situation that may match an integer.

Observation Checklist

- Listen to and observe students’ responses to determine whether students can do the following:
 - Describe contexts in which integers are used.
 - Use integers to represent contexts.

Suggestions for Instruction

- **Explain, using concrete materials such as integer tiles and diagrams, that the sum of opposite integers is equal to zero.**
- **Illustrate, using a horizontal or vertical number line, the results of adding or subtracting negative and positive integers (e.g., a move in one direction followed by an equivalent move in the opposite direction results in no net change in position).**

Materials:

- a long line on the floor or playground (e.g., use a pattern in the floor tiles, use lines painted on the gymnasium floor or sports field, or create a line with tape, chalk, or coloured dots)
- a measuring tool to create intervals
- low-tack stickers to label intervals (use a special marker for zero)
- a pile of cards labelled with integers
- two arrows, one labelled “increasing in value,” and the other labelled “decreasing in value”
- paper to create a number line (10 cm by 55 cm) (optional)

Organization: Small groups

Procedure:

1. Create a number line on the classroom floor, the gymnasium floor, or outdoors, using tape, chalk, or coloured dots. Number the line (-20) to (+20). The line can be used later for other learning experiences.
2. When the number line is complete, have students draw an integer card from the pile, show where the number would be on the line by pacing the distance from zero, and then stand at the spot on the number line that represents the integer.
 - The first student compares his or her number to zero: “___ is (*greater* or *less*) than zero.”
 - The next person compares the size of his or integer to that of a neighbour already on the line: “___ is (*greater* or *less*) than ____.”
3. Note that the farther a number is from zero, the larger or smaller its value is, depending on its direction from zero. Place arrows on the line to label increasing values or decreasing values.

Variations:

- When students state their comparison responses, they could add a value to the “greater or less than” statement. For example, instead of saying, “(-8) is less than (-6),” they could say, “(-8) is 2 less than (-6).”
- Have students create and use both vertical and horizontal number lines.
- Make a personal number line (10 cm wide and 55 cm long) on paper, label the integers (-20) to (+20), and use small cards to represent the above actions. This line may be used for other learning experiences.



Observation Checklist

- Listen to and observe students’ responses to determine whether students can do the following:
 - Create an accurate number line.
 - Order numbers correctly on a number line.

Suggestions for Instruction

- **Explain, using concrete materials such as integer tiles and diagrams, that the sum of opposite integers is equal to zero.**
- **Illustrate, using a horizontal or vertical number line, the results of adding or subtracting negative and positive integers (e.g., a move in one direction followed by an equivalent move in the opposite direction results in no net change in position).**

Materials:

- demonstration board
- BLM 7.N.6.1: Centimetre Number Line
- BLM 5–8.9: Centimetre Grid Paper
- coloured paper or markers (Decide whether to use the same colour of manipulatives to represent positive and negative integers for every activity.)
- scissors
- a directional toy (e.g., a person, animal, car) (for each student or group)
- 20 counters of two different colours (for each student or group)
- math journals or notebooks

Organization: Whole class, individual or small groups

Procedure:

The purpose of this learning activity is to determine the sum of opposite integers.

1. Remind students that integers measure quantity and direction from zero.
2. Ask students to use BLM 5–8.9: Centimetre Grid Paper to measure and cut five strips of paper the length of five different positive integers. The strips should be of the same colour and the same height. Have students mark zero at the left end of the strip, the integer at the right end, and the vector arrow the length of the strip and pointing to the right, indicating that the strip represents a positive integer.

Example:



Ask students to use another colour to create strips representing the negative or opposite of each chosen integer. This time, have students label zero at the right end of the strip, the integer at the left end, and the vector arrow pointing to the left, indicating that the strip represents a negative integer.

Example:

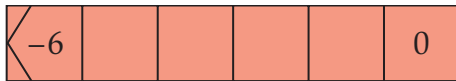

3. Demonstrate how to combine the opposite strips on the number line to represent adding opposite integers: $(+5) + (-5) = \underline{\quad}$. Place the beginning or zero point of the vector arrow of the strip representing the first integer at zero, and place the beginning or zero point of the vector arrow of the strip representing the second integer at the end or integer value of the first strip. The resulting end point of the second strip can be read on the number line. In this case, it is zero.

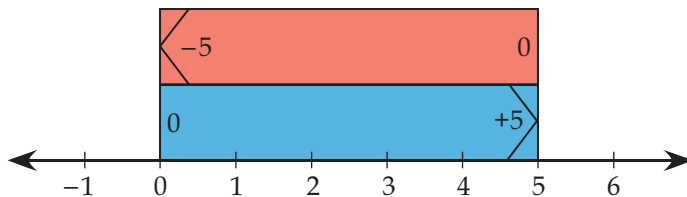

4. Ask students to use their strips to model five combinations of different integers and their opposites, and to write a general statement about the sum of an integer and its opposite, recording their work in their math journals or notebooks.
5. After giving students sufficient time to work on their combinations, ask students what they discovered. Record each of their combinations on the demonstration board as equations. Ask students to make a general statement about the sum of an integer and its opposite.

6. Ask students to imagine that the number line is an elevator shaft. Use of a vertical number line is realistic for this situation. Have a student demonstrate entering at level zero, go up three floors, and then come back down three floors. The elevator will be back where it started. There has been zero change.
7. Demonstrate the combination $(+5) + (-5) = \underline{\quad}$ as jumps on a number line. If you are using the large line, have a student begin at zero and take 5 positive jumps, facing to the positive right. The next action is adding or combining, so the student continues to face right, ready to jump on. The next integer is negative though. It is the opposite of 5, so the student must face the same direction and jump backwards to show the opposite of 5. The number to which the student jumps indicates the sum. Have students demonstrate several of their opposite combinations. Be sure to act out some combinations beginning with negative integers. Also act out the same combinations beginning at any floor in the elevator scenario, or beginning at any number on the number line. Adding one value and then its opposite results in zero or no net change to the original position or number. If you do not have access to a large number line, have students use a directional toy with a front (e.g., a car, an animal) to act out the situations on their individual number lines. Number lines measuring 10 cm \times 55 cm are handy and can be used for many learning experiences. Review the generalizations about adding integers and their opposites, as discussed in the Background Information for learning outcome 7.N.6. Inform students this is called the *zero principle*.
8. Distribute two colours of counters to students. State the colour that will represent positive integers, and the colour that will represent negative integers. Remind students of the zero principle they have just established, and ask them how they could use the counters to illustrate that the sum of an integer and its opposite is zero. Circulate among students and, after sufficient time, have students share their ideas. Listen for the idea that matching a positive and a negative counter equals zero, so the pair can be withdrawn. If all the integers match up as opposite pairs, there is nothing remaining, and the value of the leftovers is zero.

Example:

This example represents $(+3) + (-3)$, and each $(+1) + (-1)$ pair can cancel, leaving 0.

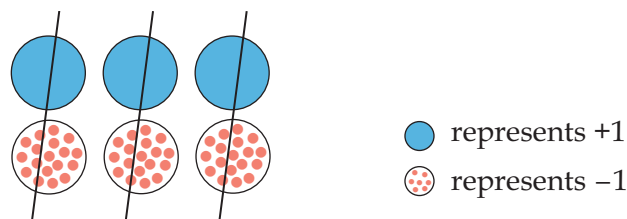

Computer applets may also be used to illustrate that the sum of an integer and its opposite is zero.

Sample Website:

Computer applets are available on the following website:

Utah State University. *National Library of Virtual Manipulatives*. 1999–2010.

<http://nlvm.usu.edu/en/nav/vlibrary.html>.

Select Number and Operations (Grades 3–5), and then select Color Chips—Addition.

9. Students record the zero principle in their math journals or notebooks and draw diagrams and the corresponding number sentences to illustrate the generalization. Encourage them to draw both horizontal and vertical number lines.

Variations:

- Supply number lines and cut strips for students to work with.
- Supply templates on which students can record the zero principle.



Observation Checklist

- Listen to and observe students' responses to determine whether students can do the following:
 - Explain, using concrete materials such as integer tiles and diagrams, that the sum of opposite integers is equal to zero.
 - Illustrate, using a horizontal or vertical number line, the results of adding or subtracting negative and positive integers (e.g., a move in one direction followed by an equivalent move in the opposite direction results in no net change in position).

Suggestions for Instruction

- **Illustrate, using a horizontal or vertical number line, the results of adding or subtracting negative and positive integers (e.g., a move in one direction followed by an equivalent move in the opposite direction results in no net change in position).**
- **Add two integers using concrete materials or pictorial representations, and record the process symbolically.**
- **Subtract two integers using concrete materials or pictorial representations, and record the process symbolically.**
- **Solve a problem involving the addition and subtraction of integers.**

Materials:

- demonstration board
- number lines (a large physical number line such as the one used in the previous learning activity, or a personal number line)
- small directional toy (e.g., a person, an animal, a car)
- 20 counters of two different colours (for each student or group)
- containers or paper boundaries in which to place the counters (for each student or group)
- index cards
- rulers, pencils, and colours
- display area (to post completed scenarios)
- math journals or notebooks

Organization: Whole class (for demonstration), small groups (for investigations)

Procedure:

1. Remind students that in a previous learning experience they modelled adding opposite integers using a number line by comparing distances, and representing moves or jumps on a number line. They also modelled making zero pairs using two colours of counters. In this learning activity, students will extend their modelling to represent adding or subtracting any integers (-20) to $(+20)$. Ask students to use their number lines or counters to model scenarios, and use integers to write corresponding addition and subtraction statements to represent the action in the scenarios. Encourage students to use both the number lines and the counters to model scenarios. Include a subtraction scenario that requires adding more integers using zero pairs.

Example:

In this example, the dotted chip represents negative and the solid chip represents positive.

To model $(+3) - (+5)$, start with $+3$.

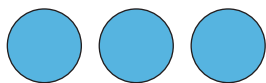

Then remove $+5$ (but there are only 3 to remove, so it is necessary to add enough zero pairs so that there are 5 positives to take away).

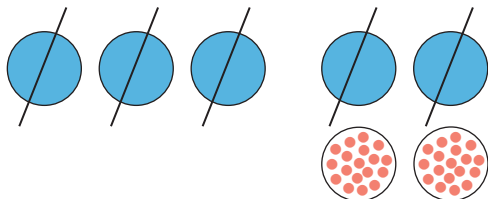

You are left with -2 , so $(+3) - (+5) = (-2)$.

2. Present sample scenarios, such as those suggested below. In the samples, have students model the action both on the number lines and with counters to gain experience with both models. Record the representative equation using integers.

Sample Scenarios:

- Lucienne put \$8 in an envelope in the morning. Later in the day, he put \$2 in the envelope. How much money is in the envelope?

$$(+8) + (+2) = (+10)$$

- Ricki was in a cycling derby. She rode 5 km, and realized she missed the turn by the oak grove, which was 2 km back. How much of the course has she completed?

$$(+5) + (-2) = (+3)$$

Here, students may begin to notice that subtracting the positive integer and adding the negative integer are equivalent.

- It was a dry summer in Okitown. The river was 2 m below its normal level. During August, there was no rain, and the water level went down another metre. How far is the river below the normal level now?

$$(-2) + (-1) = (-3)$$

- Ainsley owed her dad \$12. Her dad cancelled \$5 of the debt. How much debt remains?

$$(-12) - (-5) = (-7)$$

- Ravi had a collection of model cars. He sold three cars to friends at school, and used the money to purchase a new model. What is the resulting change in the number of cars in his collection?

$$(-3) + (+1) = (-2)$$

Remind students to use integers to represent the quantities.

3. When students have developed sufficient proficiency in modelling scenarios, have them work in small groups to write scenarios, act them out, and identify the corresponding equations using integers. Remind students to vary the action models they use, sometimes using number lines and sometimes using counters. When a scenario is completed, they record the situation on one side of an index card. On the reverse side, they draw a pictorial representation of the solution, and write the corresponding integer equation(s). Aim for a variety of addition and subtraction scenarios combining positive and negative integers. As students work together in groups, ask them to look for generalizations or rules they can apply when adding or subtracting integers. As groups complete cards, have them verify their correctness, write their group name on each card, and post the cards in the designated area so classmates have access to them.
4. When groups have completed five cards, they can select a few scenarios from their classmates and write the solutions in their math journals or notebooks. Ask them to include diagrams of manipulatives used, and to write an applicable equation.
5. Meet together as a class and have students share any generalizations or methods that were helpful to them. Students may record useful generalizations in their math journals or notebooks.

Variations:

- Provide students with scenarios instead of having them create their own.
- Provide a handout with necessary supports for solving the scenarios.
- Include online computer applets of integer counters as manipulatives for students to use while solving their scenarios.



Observation Checklist

- Listen to and observe students' responses to determine whether students can do the following:
 - Illustrate, using a horizontal or vertical number line, the results of adding or subtracting negative and positive integers (e.g., a move in one direction followed by an equivalent move in the opposite direction results in no net change in position).
 - Add two given integers using concrete materials or pictorial representations, and record the process symbolically.
 - Subtract two given integers using concrete materials or pictorial representations, and record the process symbolically.
 - Solve a given problem involving the addition and subtraction of integers.
 - Visualize the integers to assist in symbolically adding and subtracting integers.

Suggestions for Instruction

- **Solve a problem involving the addition and subtraction of integers.**

Materials:

- a deck of regular playing cards
- number lines
- counters
- paper and pencils (for finding solutions)

Organization: Pairs or small groups (of three or four students)

Procedure:

In this learning activity, students play a game requiring them to calculate the value of integer cards.

1. Decide which cards (red or black) will represent positive integers, and which cards will represent negative integers. Aces will have a value of 1. Jokers may be included as zero cards. Decide whether to include the face cards as values 11, 12, and 13, or whether to remove them and work with integers 0 to 10.
2. Have students form pairs or small groups. Then deal all the cards evenly among the players. Players put their cards in a pile face down. On the dealer's signal, all players flip over their top cards, making them easily visible to all. All players calculate the value of the cards. The first person to say the correct value takes the up-turned cards and puts them in his or her win pile. The dealer signals for the next round, and play continues. When someone's pile is depleted, the player shuffles his or her win pile and continues playing with it. Once someone has no remaining cards, that player becomes a referee. Play continues until a set time is called, or until only one player has all the cards. The player with the most cards wins.

Variation:

- Use the cards to play integer baseball, using the process outlined in the Assessing Prior Knowledge learning experience. This time, the pitcher has two card piles. The top cards are turned over, and the batter returns the combined value. An error results in an "out."



Observation Checklist

- Listen to and observe students' responses to determine whether students can do the following:
 - Solve a given problem involving the addition and subtraction of integers.
 - Apply mental mathematics strategies when adding and subtracting integers.

Suggestions for Instruction

- **Illustrate, using a horizontal or vertical number line, the results of adding or subtracting negative and positive integers (e.g., a move in one direction followed by an equivalent move in the opposite direction results in no net change in position).**
- **Solve a problem involving the addition and subtraction of integers.**

Materials:

- BLM 7.N.6.2: Integer Football
- blank game cards
- markers and tokens
- paper or card stock (for a football field)
- scoreboard
- rulers, scissors, and tape
- word processor and printer (optional)

Organization: Pairs or small groups

Procedure:

1. Ask students to work in pairs or in small groups to develop a football game requiring players to answer integer problems. Have them prepare rules of play and any required materials, such as those listed below. In designing their games, students may wish to refer to BLM 7.N.6.2: Integer Football.

Game Suggestions:

- Draw a paper football field with the yards and end zones marked off.
- Provide a token (for each team) and a "ball."
- Prepare sets of game cards, including run cards and pass cards, each with appropriate integer statements or problems, and the solutions on the reverse or under a fold. (The solutions would be the yards gained or lost on the play.)

- Identify rules of play, including penalties or interceptions for incorrect challenges.
 - Provide a scoreboard.
2. Have students play each other's games.

Variations:

- Supply the materials and cards and have students play the game.
- Have students develop any other game requiring players to answer integer problems to score points or to advance a play.



Observation Checklist

- Listen to and observe students' responses to determine whether students can do the following:
 - Solve a given problem involving the addition and subtraction of integers.

Number (7.N.7)

Enduring Understanding(s):

Percents, fractions, decimals, and ratios are different representations of the same quantity.

Number sense and mental mathematics strategies are used to estimate answers and lead to flexible thinking.

General Learning Outcome(s):

Develop number sense.

SPECIFIC LEARNING OUTCOME(S):	ACHIEVEMENT INDICATORS:
<p>7.N.7 Compare and order fractions, decimals (to thousandths), and integers by using</p> <ul style="list-style-type: none">■ benchmarks■ place value■ equivalent fractions and/or decimals. <p>[CN, R, V]</p>	<ul style="list-style-type: none">→ Order the numbers of a set that includes fractions, decimals, or integers in ascending or descending order, and verify the result using a variety of strategies.→ Identify a number that would be between two numbers in an ordered sequence or on a horizontal or vertical number line.→ Identify incorrectly placed numbers in an ordered sequence or on a horizontal or vertical number line.→ Position fractions with like and unlike denominators from a set on a horizontal or vertical number line, and explain strategies used to determine order.→ Order the numbers of a set by placing them on a horizontal or vertical number line that contains benchmarks, such as 0 and 1 or 0 and 5.→ Position a set of fractions, including mixed numbers and improper fractions, on a horizontal or vertical number line, and explain strategies used to determine position.

PRIOR KNOWLEDGE

Students may have had experience with the following:

- Demonstrating an understanding of fractions by using concrete and pictorial representations to
 - name and record fractions for the parts of a whole or a set
 - compare and order fractions with like and unlike denominators
 - model and explain that for different wholes, two identical fractions may not represent the same quantity
 - provide examples of where fractions are used
 - create sets of equivalent fractions
 - relate improper fractions to mixed numbers
- Describing and representing decimals (tenths, hundredths, thousandths) concretely, pictorially, and symbolically.
- Relating decimals to fractions (tenths, hundredths, thousandths).
- Comparing and ordering decimals (tenths, hundredths, thousandths) by using
 - benchmarks
 - place value
 - equivalent decimals
- Demonstrating an understanding of place value for numbers
 - greater than one million
 - less than one-thousandth
- Demonstrating an understanding of percent (limited to whole numbers), concretely, pictorially, and symbolically.

For more information on prior knowledge, refer to the following resource:

Manitoba Education and Advanced Learning. *Glance Across the Grades: Kindergarten to Grade 9 Mathematics*. Winnipeg, MB: Manitoba Education and Advanced Learning, 2015. Available online at www.edu.gov.mb.ca/k12/cur/math/glance_k-9/index.html.

RELATED KNOWLEDGE

Students should be introduced to the following:

- Demonstrating an understanding of the addition, subtraction, multiplication, and division of decimals to solve problems (for more than 1-digit divisors or 2-digit multipliers, technology could be used).
- Solving problems involving percents from 1% to 100%.

- Demonstrating an understanding of the relationship between repeating decimals and fractions, and terminating decimals and fractions.
- Demonstrating an understanding of adding and subtracting positive fractions and mixed numbers, with like and unlike denominators, concretely, pictorially, and symbolically (limited to positive sums and differences).
- Demonstrating an understanding of addition and subtraction of integers, concretely, pictorially, and symbolically.
- Expressing probabilities as ratios, fractions, and percents.

BACKGROUND INFORMATION

Comparing and Ordering Fractions, Decimals, and Integers

To be efficient at comparing and ordering fractions, decimals, and integers, students must understand the values of these numbers in our number system and their various representations. They must realize that fractions and decimals are interchangeable names for the same quantity and must be able to convert one to the other. They must be proficient at renaming and simplifying fractions and use multiple strategies for comparing them.

Fractions

Fractions are used to name quantities between whole numbers. The part between whole numbers can be divided into any number of equal parts. The number of equal parts in one whole becomes the *denominator* of the fraction, and the number of parts referred to forms the *numerator* of the fraction. The larger the denominator is, the smaller the fraction pieces are. The smaller the denominator is, the larger the fraction pieces are. For example, $\frac{1}{15}$ is less than $\frac{1}{10}$. As the numeric value of the numerator approaches the numeric value of the denominator, the number gets closer to one whole. For example, $\frac{14}{15}$ is larger than $\frac{9}{10}$. Numerators with numeric values larger than their denominators represent *improper fractions* with values greater than one whole. *Equivalent fractions* have different numerators and denominators, but represent the same portion of a whole. (The learning experiences suggested for learning outcomes 7.N.3, 7.N.4, and 7.N.5 contain information about, and strategies for, renaming equivalent fractions and mixed numbers. They are recommended for students who need to review these skills.)

Decimals

Decimal numbers represent fraction quantities using the base-10 number system. Each successive decimal place represents a tenth of the previous place value. All fractions can be renamed as decimals.

- One way to rename a fraction as a decimal is to find an equivalent fraction with a denominator that is a power of 10.

Examples:

$$\frac{1}{2} \text{ is equal to } \frac{5}{10}, \text{ written as } 0.5$$

$$\frac{12}{25} \text{ is equal to } \frac{48}{100}, \text{ written as } 0.48$$

- Another way to rename a fraction as a decimal is to divide the numerator by the denominator.

Example:

$$\frac{12}{40} = 12 \div 40 = 0.3$$

Likewise, most decimal numbers can be renamed as fractions. *Terminating decimals* have a definite number of digits and can easily be renamed as fractions with denominators that are powers of 10. The digits in the decimal number form the numerator of the fraction, and the denominator is 1, followed by a number of zeros equal to the number of digits to the right of the decimal number (e.g., $0.623 = \frac{623}{1000}$ and $3.4 = 3\frac{4}{10}$). *Repeating decimals* can be renamed as fractions according to characteristic patterns explored in relation to learning outcome 7.N.4 (a single repeating digit has a denominator of 9, so $0.\overline{7} = \frac{7}{9}$). Decimals that are both non-repeating and non-terminating are irrational numbers, and, therefore, cannot be renamed as fractions (e.g., π , $\sqrt{2}$).

Integers

Integers comprise positive numbers, negative numbers, and zero. Positive integers refer to the regular counting numbers, and negative integers refer to numbers less than zero. Negative integers are the opposite of their positive counterparts. The greater the numeric value of the negative integer is, the farther it is from zero, and, therefore, the smaller is the value of the number. For example, (-9) is smaller than (-1).

Strategies for Comparing Relative Size

Strategies for comparing the relative size of fractions, decimals, and integers include the following:

- Associate the numbers with *benchmarks* such as 0 , $\frac{1}{2}$, and 1 , and place them on a number line. For closer comparisons, use benchmarks of 0 , $\frac{1}{4}$, $\frac{1}{2}$, $\frac{3}{4}$, and 1 .
- All negative integers are less than 0 . The greater the numeric value is, the smaller the number is.
- If fractions have the same numerator, then it is necessary to compare only the denominators. The larger the denominator is, the smaller each piece is. If the numerator is 1 , then the larger the denominator is, the closer the fraction is to zero (e.g., $\frac{1}{9}$ is closer to zero than $\frac{1}{5}$ is).
- If fractions have the same denominator, then it is necessary to compare only the numerators. The larger the numerator is, the more pieces there are, and so the larger the fraction is.
- If the numerator is close to half of the denominator, then the fraction is close to one-half (e.g., $\frac{3}{8}$ is a little less than $\frac{1}{2}$, and $\frac{5}{8}$ is a little more than $\frac{1}{2}$).
- If the numerator is close to the denominator, then the number is close to one whole. A larger denominator indicates smaller pieces. The smaller the piece is, the closer it is to 1 , and the larger the fraction is.
- Compare decimal numbers to the decimal equivalents for the benchmark fractions, 0.25 , 0.5 , 0.75 , and 1.0 .
- Use an understanding of place value to compare decimal numbers. First, compare the units in the largest place value. Tenths are larger than hundredths, which are larger than thousandths (e.g., 0.543 is a little larger than 0.54 , which is a little larger than 0.5). Rewriting decimal numbers as equivalents with the same number of digits helps make this concept clear (e.g., 0.543 is larger than 0.540 , which is larger than 0.500).
- Move flexibly between the various representations (e.g., $\frac{7}{10}$ is larger than $\frac{17}{25}$ because $\frac{7}{10}$ is 0.7 , and $\frac{17}{25}$ is $\frac{68}{100}$ or 0.68).

MATHEMATICAL LANGUAGE

ascending
benchmark
denominators
descending
equivalent fractions
horizontal
improper fractions
mixed numbers
numerators
proper fractions
repeating decimal
sequence
terminating decimal
unlike denominators
verify
vertical

LEARNING EXPERIENCES



Assessing Prior Knowledge

Materials:

- BLM 7.N.7.1: Equivalent Fractions and Decimals
- BLM 7.N.7.2: Equivalent Fractions, Decimals, and Percents
- manipulatives for representing fractions and decimals (e.g., counters, fraction bars, number lines, base-10 blocks)
- math journals or notebooks
- calculators (optional)

Organization: Individual or pairs, whole class

Procedure:

1. Select a BLM for students to work with (e.g., BLM 7.N.7.1: Equivalent Fractions and Decimals or BLM 7.N.7.2: Equivalent Fractions, Decimals, and Percents).
2. Provide students with copies of the selected BLM, and have them complete the tasks individually or in pairs, using manipulatives or calculators as needed.
3. After a designated time has passed, reassemble as a class, and have students share their responses and the strategies they used to arrive at their answers.
4. Have students use their math journals or notebooks to record helpful strategies for converting fraction and decimal numbers. They can add to these strategies in future learning activities.

Variations:

- Have students create pictorial, equivalent fraction, decimal, and percent representations for fractions of their choice. Provide template squares, and combine the different representations as a class display.
- Have students create their own scenarios and word problems involving converting decimal and fraction notations.

Observation Checklist

- Listen to and observe students' responses to determine whether students can do the following:
 - Convert decimal numbers to fractions (to thousandths), and vice versa.
 - Relate improper fractions to mixed numbers.

Note:

Many of the learning experiences for learning outcome 7.N.7 could be used within a body of evidence to report on the following competencies on the Grade 7 Numeracy Assessment:

Student orders fractions.

Student orders decimal numbers.

Student understands that a given number may be represented in a variety of ways.

Reference:

Manitoba Education and Advanced Learning. *Middle Years Assessment: Grade 7 Mathematics: Support Document for Teachers: English Program*. Winnipeg, MB: Manitoba Education and Advanced Learning, 2015. Available online at www.edu.gov.mb.ca/k12/assess/support/math7/.



Assessing Prior Knowledge

Materials:

- blank paper
- pens of different colours

Organization: Individual, small groups or whole class

Procedure:

1. Ask students to create a brainstorming web entitled Everything I Know about Fractions.
2. Have students participate in a group or class discussion to share information from their webs.
3. Have students use pens of different colours to add new ideas to their own webs as they listen to the shared ideas of classmates.

Variation:

- Students keep the webs so that they can revisit and add to them as their conceptual understanding of fraction grows.

Observation Checklist

- Listen to and observe students' responses to determine whether students can do the following:
 - Represent a variety of fractions in various ways, such as
 - pictorially, as parts of a whole or a set
 - a ratio
 - a division statement
 - improper fractions and mixed numbers
 - equivalent fractions
 - expressed as a decimal
 - expressed as a percent

Suggestions for Instruction

- **Order the numbers of a set that includes fractions, decimals, or integers in ascending or descending order, and verify the result using a variety of strategies.**
- **Position a set of fractions, including mixed numbers and improper fractions, on a horizontal or vertical number line, and explain strategies used to determine position.**

Materials:

- BLM 7.N.7.3: Comparing Fraction and Decimal Equivalents
- BLM 5-8.10: Base-Ten Grid Paper
- BLM 5-8.12: Fraction Bars
- manipulatives for representing fractions and decimals (e.g., counters, number lines, base-10 blocks)
- calculators (optional)
- math journals or notebooks

Organization: Individual or pairs

Procedure:

1. Distribute copies of BLM 7.N.7.3: Comparing Fraction and Decimal Equivalents, and have students find solutions to the given problems, using manipulatives or calculators as needed.
2. After a designated time has passed, have students share their responses and the strategies they used to arrive at their answers.
3. Have students use their math journals or notebooks to record helpful strategies for converting and comparing fraction and decimal numbers. They can add to these strategies in future learning activities.

Variations:

- Ask students to create their own scenarios and word problems that involve converting decimal and fraction notations or that require comparing fractions and decimal numbers. Have students share their scenarios with either the class or a small group. Have individuals present and explain their solutions, and have other group members verify the solutions.



Observation Checklist

- Listen to and observe students' responses to determine whether students can do the following:
 - Convert decimal numbers to fractions (to thousandths), and vice versa.
 - Relate improper fractions to mixed numbers.
 - Compare and order fractions and decimals.

Suggestions for Instruction

- **Order the numbers of a set that includes fractions, decimals, or integers in ascending or descending order, and verify the result using a variety of strategies.**
- **Identify a number that would be between two numbers in an ordered sequence or on a horizontal or vertical number line.**
- **Identify incorrectly placed numbers in an ordered sequence or on a horizontal or vertical number line.**

Materials:

- a collection of library books labelled with decimal numbers on the spine (If possible, have three books per student. Choose books with whole numbers relatively close together, and a variety of decimal numbers in between.)
- math journals or notebooks
- card stock (optional)

Organization: Small groups (two to four students), whole class

Procedure:

1. Choose a variety of ways to form groups quickly (e.g., combinations of colours worn, beginning letters in first names).
2. Have two or three students combine their library books and sort them in ascending order according to the decimal numbers on the spines. (Groups of four can work as two groups of two.) Have group members verify that their order is correct and explain their reasoning to one another.
3. Have students reclaim their books, form new groups, sort the books, and verify the results once again. Repeat as often as the learning activity seems useful.
4. Meet as a class and have students share strategies for ordering decimal numbers.
5. Have students use their math journals or notebooks to record strategies for ordering decimal numbers.

Variations:

- Have one or two students order the books incorrectly, and have a third student identify the misplaced books and explain why the books belong elsewhere.
- Use fewer books. Designate the learning activity as one station of a set of rotating learning activities.
- Instead of using library books, use card stock to create a set of book spines labelled with titles and decimal numbers, or provide students with a handout containing images of book spines labelled with decimal numbers.



Observation Checklist

- Listen to and observe students' responses to determine whether students can do the following:
 - Order the numbers of a set that includes fractions, decimals, or integers in ascending or descending order, and verify the result using a variety of strategies.
 - Identify a number that would be between two numbers in an ordered sequence or on a horizontal or vertical number line.
 - Identify incorrectly placed numbers in an ordered sequence or on a horizontal or vertical number line.

Suggestions for Instruction

- **Order the numbers of a set that includes fractions, decimals, or integers in ascending or descending order, and verify the result using a variety of strategies.**

Materials:

- BLM 7.N.7.4: Ordering Decimal Numbers

Organization: Individual

Procedure:

1. Define *ascending order* and *descending order*.
2. Distribute copies of BLM 7.N.7.4: Ordering Decimal Numbers, and have students complete the tasks. Students place the given decimal numbers in ascending order. They then choose six of the numbers and write them in descending order.

Variations:

- Have students add decimal numbers that would fit between the given numbers.
- Create other number sets. Consider restricting the type of numbers presented in each set (e.g., use numbers containing only hundredths or only thousandths).
- Have students create their own number sets, exchange sets with a partner, order their partner's set, and then verify their partner's ordering of the sets.
- Repeat the learning activity with fractions or combinations of fractions and decimals.



Observation Checklist

- Listen to and observe students' responses to determine whether students can do the following:
 - Order the numbers of a set that includes fractions, decimals, or integers in ascending or descending order, and verify the result using a variety of strategies.

Suggestions for Instruction

- **Identify a number that would be between two numbers in an ordered sequence or on a horizontal or vertical number line.**
- **Identify incorrectly placed numbers in an ordered sequence or on a horizontal or vertical number line.**
- **Position fractions with like and unlike denominators from a set on a horizontal or vertical number line, and explain strategies used to determine order.**
- **Order the numbers of a set by placing them on a horizontal or vertical number line that contains benchmarks, such as 0 and 1 or 0 and 5.**

Materials:

- BLM 7.N.7.5: Sequential Fractions and Their Decimal Equivalents
- calculators
- 45 small blank cards
- markers
- large area to create a number line

Organization: Individual, whole class

Procedure:

1. Distribute copies of BLM 7.N.7.5: Sequential Fractions and Their Decimal Equivalents. Have students follow the directions to find the decimal equivalents for the sequential fractions, compare sizes using decimal and fraction notation, indicate equivalent fractions, and make generalizations about comparing fractions.
2. Distribute all the blank cards to students. Assign fractions to students, and ask them to write the given fractions on the blank cards. Specify a size of font so that the cards look similar. Ensure that each card contains a fraction.
3. Have students create a number line by ordering the fraction cards. Ask them to explain why they have placed numbers in a particular order.
4. Discuss strategies students used to determine the order of the fractions.
5. Choose two of the fractions on the number line, and ask students to suggest a number between the two fractions. Discuss the strategies used to determine that number.

Variations:

- Prepare number cards ahead of time, distribute them to students, and ask students to order the cards.
- Call upon groups of students to order the fraction cards they have.
- Call for all students with cards near benchmarks or between particular numbers to order their cards.
- Have students play games with the cards (e.g., call two to four students, and the student with the largest or smallest fraction wins).
- Have students write the decimal equivalents on the other side of the fraction cards. Have them alternate between the fraction and the decimal when ordering the numbers.



Observation Checklist

- Listen to and observe students' responses to determine whether students can do the following:
 - Identify a number that would be between two numbers in an ordered sequence or on a horizontal or vertical number line.
 - Identify incorrectly placed numbers in an ordered sequence or on a horizontal or vertical number line.
 - Position fractions with like and unlike denominators from a set on a horizontal or vertical number line, and explain strategies used to determine order.
 - Order the numbers of a set by placing them on a horizontal or vertical number line that contains benchmarks, such as 0 and 1 or 0 and 5.

Suggestions for Instruction

- **Identify a number that would be between two numbers in an ordered sequence or on a horizontal or vertical number line.**

Materials:

- grid paper
- rulers (to draw number lines with benchmarks)
- math journals or notebooks
- bolts of various sizes and a socket set (optional)

Organization: Pairs, whole class, individual

Procedure:

1. Select the type of numbers to work with (e.g., fractions, mixed numbers, decimals, integers, combinations).
2. Select the size and the orientation of the number line (e.g., $0 - 1$, $(-5) - (+5)$, horizontal, vertical). Draw the number line and mark some benchmarks.
3. Assign roles to pairs of students. For example, player A will write above a horizontal number line, or to the left of a vertical number line, and player B will write below a horizontal number line, or to the right of a vertical number line. Choose which player will play first.
4. Player A marks a point on the line, and, writing above the line, draws an arrow to the point and labels the point with an approximate value.
5. Player B marks another point on the line, and, writing below the line, draws an arrow to the point and labels the point with an approximate value.
6. Player A then marks and labels a point that can be found between the last two marked points.
7. Player B then marks and labels a point between the last two marked points.
8. Play continues until one of the players can no longer place points on the number line.
9. When students have had sufficient time for the learning activity, have them reassemble as a class and discuss strategies they used to find a number between two fractions, decimals, or integers. (See Background Information for strategies.)
10. Have students use their math journals or notebooks to record strategies for finding a number between two fractions, decimals, or integers.

Variations:

- Provide students with pre-marked number lines.
- Play the game as a class, selecting students to place numbers on a demonstration number line.
- Provide students with two numbers (e.g., $\frac{1}{3}$ and $\frac{3}{5}$, or 1.4 and $1\frac{3}{4}$) and ask them to identify a number between the given numbers. Discuss the strategies they used to identify the number.
- Designate the learning activity as one station of a set of rotating learning activities. Use an assortment of bolt sizes and a socket set as an alternative to a number line. Have students find a bolt between two specified bolt sizes. Use the sockets to verify the order.



Observation Checklist

- Listen to and observe students' responses to determine whether students can do the following:
 - Identify a number that would be between two numbers in an ordered sequence or on a horizontal or vertical number line.

Suggestions for Instruction

- **Order the numbers of a set by placing them on a horizontal or vertical number line that contains benchmarks, such as 0 and 1 or 0 and 5.**
- **Position a set of fractions, including mixed numbers and improper fractions, on a horizontal or vertical number line, and explain strategies used to determine position.**

Materials:

- BLM 7.N.7.6: Relating Numbers to Benchmarks
- pens or pencils of different colours

Organization: Individual, small groups, whole class

Procedure:

1. Distribute copies of BLM 7.N.7.6: Relating Numbers to Benchmarks, and have students complete the sheet individually. They place numbers (e.g., words, pictures, symbols, proper fractions, improper fractions, mixed numbers, decimals, integers, percents) in the appropriate boxes labelled as follows: less than one-half, equal to one-half, and greater than one-half. They then place eight selected numbers on a number line by drawing a point and a label for each number, explaining their placement choices.

2. Have students form small groups of two to four. Ask them to share examples of their numbers, number lines, and strategies. If they wish, they may make revisions to their sheets, using a different coloured pen or pencil.
3. Meet as a class and have students share examples and strategies.



Observation Checklist

- Listen to and observe students' responses to determine whether students can do the following:
 - Order the numbers of a set by placing them on a horizontal or vertical number line that contains benchmarks, such as 0 and 1 or 0 and 5.
 - Position a set of fractions, including mixed numbers and improper fractions, on a horizontal or vertical number line, and explain strategies used to determine position.

Suggestions for Instruction

- **Order the numbers of a set that includes fractions, decimals, or integers in ascending or descending order, and verify the result using a variety of strategies.**
- **Position a set of fractions, including mixed numbers and improper fractions, on a horizontal or vertical number line, and explain strategies used to determine position.**

Materials:

- BLM 7.N.7.7: Ordering Numbers and Verifying the Order
- sets of six to ten numbers, including combinations of proper and improper fractions, mixed numbers, integers, decimal numbers, and percents
- presentation board
- blank paper
- blank cards (optional)

Organization: Whole class, individual

Procedure:

1. Present students with a set of numbers and ask them to place the numbers in order. Specify whether you would like ascending or descending order.
2. Choose students to demonstrate the order and to explain strategies they used to place the numbers.

3. Repeat the process with other number sets, or ask students to suggest numbers. Each time, discuss strategies students used to place the numbers.
4. Distribute copies of BLM 7.N.7.7: Ordering Numbers and Verifying the Order. Have students draw a vertical or a horizontal number line, place a set of numbers on the line, and explain the strategies they used.

Variation:

- Write number sets on cards, distribute the cards, and have students line up with their cards in ascending or descending order. Classmates can share how they know a number is in the correct order, or why it is out of place.



Observation Checklist

- Listen to and observe students' responses to determine whether students can do the following:
 - Order the numbers of a set that includes fractions, decimals, or integers in ascending or descending order, and verify the result using a variety of strategies.
 - Position a set of fractions, including mixed numbers and improper fractions, on a horizontal or vertical number line, and explain strategies used to determine position.

NOTES



GRADE 7 MATHEMATICS

Patterns and Relations

Patterns and Relations (Patterns, and Variables and Equations) (7.PR.1, 7.PR.2, 7.PR.3, 7.PR.4, 7.PR.5, 7.PR.6, 7.PR.7)

Enduring Understanding(s):

Words, tables, graphs, and expressions are different representations of the same pattern.

Preservation of equality is used to solve equations.

The principles of operations used with whole numbers also apply to operations with decimals, fractions, and integers.

Number sense and mental mathematics strategies are used to estimate answers and lead to flexible thinking.

General Learning Outcome(s):

Use patterns to describe the world and solve problems.

Represent algebraic expressions in multiple ways.

Note:

Background Information for the Patterns and Relations strand is presented in a slightly different order than in other strands. This variation is intended to accommodate learning experiences that integrate achievement indicators from learning outcomes in both the Patterns substrand and the Variables and Equations substrand. Some achievement indicators related to Variables and Equations are developed using student experiences devoted to exploring Patterns.

SPECIFIC LEARNING OUTCOME(S):	ACHIEVEMENT INDICATORS:
<p>7.PR.1 Demonstrate an understanding of oral and written patterns and their equivalent relations. [C, CN, R]</p>	<ul style="list-style-type: none"> → Formulate a relation to represent the relationship in an oral or a written pattern. → Provide a context for a relation that represents a pattern. → Represent a pattern in the environment using a relation.

(continued)

SPECIFIC LEARNING OUTCOME(S):	ACHIEVEMENT INDICATORS:
<p>7.PR.2 Construct a table of values from a relation, graph the table of values, and analyze the graph to draw conclusions and solve problems. [C, CN, R, V]</p>	<ul style="list-style-type: none"> → Create a table of values for a relation by substituting values for the variable. → Create a table of values using a relation, and graph the table of values (limited to discrete elements). → Sketch the graph from a table of values created for a relation, and describe the patterns found in the graph to draw conclusions (e.g., graph the relationship between n and $2n + 3$). → Describe the relationship shown on a graph using everyday language in spoken or written form to solve problems. → Match a set of relations to a set of graphs. → Match a set of graphs to a set of relations.
<p>7.PR.3 Demonstrate an understanding of preservation of equality by</p> <ul style="list-style-type: none"> ■ modelling preservation of equality, concretely, pictorially, and symbolically ■ applying preservation of equality to solve equations <p>[C, CN, PS, R, V]</p>	<ul style="list-style-type: none"> → Model the preservation of equality for addition, subtraction, multiplication, or division using concrete materials or using pictorial representations, explain the process orally, and record it symbolically. → Solve a problem by applying preservation of equality.
<p>7.PR.4 Explain the difference between an expression and an equation. [C, CN]</p>	<ul style="list-style-type: none"> → Identify and provide an example of a constant term, a numerical coefficient, and a variable in an expression and an equation. → Explain what a variable is and how it is used in an expression. → Provide an example of an expression and an equation, and explain how they are similar and different.
<p>7.PR.5 Evaluate an expression given the value of the variable(s). [CN, R]</p>	<ul style="list-style-type: none"> → Substitute a value for each unknown in an expression and evaluate the expression.

(continued)

SPECIFIC LEARNING OUTCOME(S):	ACHIEVEMENT INDICATORS:
<p>7.PR.6 Model and solve problems that can be represented by one-step linear equations of the form $x + a = b$, concretely, pictorially, and symbolically, where a and b are integers. [CN, PS, R, V]</p>	<ul style="list-style-type: none"> → Represent a problem with a linear equation and solve the equation using concrete models. → Draw a visual representation of the steps required to solve a linear equation. → Solve a problem using a linear equation. → Verify the solution to a linear equation using concrete materials or diagrams. → Substitute a possible solution for the variable in a linear equation to verify the equality.
<p>7.PR.7 Model and solve problems that can be represented by linear equations of the form:</p> <ul style="list-style-type: none"> ■ $ax + b = c$ ■ $ax = b$ ■ $\frac{x}{a} = b, a \neq 0$ <p>concretely, pictorially, and symbolically, where $a, b,$ and $c,$ are whole numbers. [CN, PS, R, V]</p>	<ul style="list-style-type: none"> → Model a problem with a linear equation and solve the equation using concrete models. → Draw a visual representation of the steps used to solve a linear equation. → Solve a problem using a linear equation and record the process. → Verify the solution to a linear equation using concrete materials or diagrams. → Substitute a possible solution for the variable in a linear equation to verify the equality.

PRIOR KNOWLEDGE

Students may have had experience with the following:

- Describing and applying mental mathematics strategies, such as
 - skip-counting from a known fact
 - using doubling or halving
 - using doubling and adding one more group
 - using patterns in the 9s facts
 - using repeated doubling
 to develop recall of basic multiplication facts to 9×9 and related division facts.
- Using charts, tables, graphs, and diagrams to
 - identify and describe patterns
 - reproduce a pattern using concrete materials
 - represent patterns and describe relationships to solve problems
 - identify and explain mathematical relationships to solve problems

- Expressing a problem as an equation in which a symbol is used to represent an unknown number.
- Solving one-step equations involving a symbol to represent an unknown number.
- Determining the pattern rule to make predictions about subsequent elements.
- Solving problems involving single-variable (expressed as symbols or letters), one-step equations with whole-number coefficients, and whole-number solutions.
- Demonstrating an understanding of factors and multiples by
 - determining multiples and factors of numbers less than 100
 - identifying prime and composite numbers
 - solving problems involving factors or multiples
- Demonstrating an understanding of ratio, concretely, pictorially, and symbolically.
- Demonstrating an understanding of integers, concretely, pictorially, and symbolically.
- Demonstrating an understanding of the relationships within tables of values to solve problems.
- Representing generalizations arising from number relationships using equations with letter variables.
- Demonstrating and explaining the meaning of preservation of equality concretely, pictorially, and symbolically.
- Identifying and plotting points in the first quadrant of a Cartesian plane using whole-number ordered pairs.
- Creating, labelling, and interpreting line graphs to draw conclusions.
- Graphing collected data and analyzing the graph to solve problems.

For more information on prior knowledge, refer to the following resource:

Manitoba Education and Advanced Learning. *Glance Across the Grades: Kindergarten to Grade 9 Mathematics*. Winnipeg, MB: Manitoba Education and Advanced Learning, 2015. Available online at www.edu.gov.mb.ca/k12/cur/math/glance_k-9/index.html.

RELATED KNOWLEDGE

Students should be introduced to the following:

- Determining and explaining why a number is divisible by 2, 3, 4, 5, 6, 8, 9, or 10, and why a number cannot be divided by 0.
- Demonstrating an understanding of adding and subtracting positive fractions and mixed numbers, with like and unlike denominators, concretely, pictorially, and symbolically (limited to positive sums and differences).

- Demonstrating an understanding of addition and subtraction of integers, concretely, pictorially, and symbolically.
- Comparing and ordering fractions, decimals (to thousandths), and integers by using
 - benchmarks
 - place value
 - equivalent fractions and/or decimals
- Demonstrating an understanding of circles by
 - describing the relationships among radius, diameter, and circumference of circles
 - relating circumference to pi
 - determining the sum of the central angles
 - constructing circles with a given radius or diameter
 - solving problems involving the radii, diameters, and circumferences of circles
- Developing and applying a formula for determining the area of
 - triangles
 - parallelograms
 - circles
- Identifying and plotting points in the four quadrants of a Cartesian plane using ordered pairs.
- Performing and describing transformations of a 2-D shape in all four quadrants of a Cartesian plane (limited to integral vertices).
- Demonstrating an understanding of central tendency and range by
 - determining the measures of central tendency (mean, median, mode) and range
 - determining the most appropriate measures of central tendency to report findings
- Constructing, labelling, and interpreting circle graphs to solve problems.

BACKGROUND INFORMATION

Patterns

The world is full of patterns. They are found in multiple contexts both in nature and in the creations of people. Patterns are prevalent in plant and animal life, as well as in the physical world. They are evident in the arts, music, structures, movement, time, and space. Our number system is rooted in pattern, and an understanding of pattern is the basis of mathematical concepts in every strand of mathematics.

As students interpret patterns and generalize the relationships represented by them, they develop algebraic thinking and reasoning skills that enable them to apply mathematics in everyday situations. These generalizations and the equations and formulas derived from them are powerful tools for making predictions and solving problems. They make mathematics meaningful, and are also important for the mathematics that students will study in later grades.

Someone who possesses the ability to identify a new pattern and its symbolic relation can solve a problem that previously seemed insurmountable. That person may make a new relational discovery leading to a new advancement in science or technology. Such was the case with Dmitri Mendeleev's work on the periodic table, Albert Einstein's formulation of the $E = mc^2$ equation, and the more recent work on the relationships between prime numbers and quantum mechanics.

Of more interest to Middle Years students will be the schoolroom mathematics story commonly attributed to the German mathematician Carl Gauss. Around 1787, Carl Gauss's teacher directed his class to find the sum of the consecutive numbers 1 to 100. The 10-year-old Carl promptly submitted an answer of 5050. When questioned how he could possibly perform the calculation so quickly, Carl explained he did not add the numbers from 1 to 100. Rather, he saw a pattern. He paired the largest and the smallest numbers ($1 + 100 = 101$, $2 + 99 = 101$, $3 + 98 = 101$), and determined the set contained 50 such pairs, each totalling 101. Thus, the total sum was 50×101 , or 5050. Presenting the same task to students in today's classroom will likely uncover some interesting discussion regarding patterns, and reveal that there are many ways to view a problem and its solution.

The process of making connections in patterns is developed in the learning outcomes of previous grades. It involves converting patterns to numeric values, extending the patterns, graphing the patterns, and explaining the mathematical relationship between the quantities. The relationship is expressed in mathematical symbols using the language of algebra and extended to an equation or formula. The Grade 7 learning outcomes focus on matching symbolic relations, in the form of algebraic expressions and equations, with pattern contexts and the representations of these relations as tables of values and graphs. The relations are then used to solve problems. The ability to extend patterns and represent them as tables, graphs, and equations is assessed in the Grade 7 Numeracy Assessment. Therefore, background information regarding patterns, how to represent them, and how to identify the relationships within them is provided, beginning with a discussion of the categories of patterns.

Categories of Patterns

For the purposes of this document, there are two main categories of patterns: repeating patterns and growing patterns.

- Repeating patterns:** *Repeating patterns* consist of repeated sequences or arrangements of items about which predictions can be made. In a repeating pattern, a set of elements, referred to as a *core*, appears in a set order over and over again, or appears as a transformation over and over again. Colour patterns, shape patterns, rhyme patterns, and tessellations are examples of repeating patterns. Numerals may also be arranged in repeating patterns.

Examples:

★ ★ ○ ★ ★ ○ ★ ★ ○

121312131213

- Growing patterns:** *Growing patterns* (also called *sequences* or *number patterns*) consist of a series of steps called *figures* or *terms*. Each term is related to the previous term according to a pattern. The terms are numbered according to their sequential order, and each term is assigned a corresponding numeric term value, which is determined by the number of items in that term. Growing patterns may grow or shrink, depending on whether the numeric values of the terms increase or decrease. The growth may occur at a constant or non-constant rate.

Example:

Growing Patterns						
Pictorial representation of a pattern	•••	•• •••	•• •• •••	•• •• •• •••		
Term number (the position of the term in the sequence)	1	2	3	4	5	6
Term value (the number of items in the term)	3	5	7	9		

Growing patterns, which are emphasized in Grade 7, are further classified as arithmetic sequences or geometric sequences.

- **Arithmetic sequences:** In arithmetic sequences, the rate of change is constant.
 - Each term value changes by a fixed amount in relation to the previous term value.
 - A particular value is added to or subtracted from the previous term value.
 - An example is the pattern 2, 4, 6, . . . , where each successive term value increases by a value of 2.
 - Arithmetic sequences are generally easier to identify than geometric sequences.
- **Geometric sequences:** In geometric sequences, the next term value is a multiple of the previous term value. Pattern growth is not constant.
 - In the example 2, 4, 8, 16, . . . , each term value is twice the previous value.
 - In the example 900, 300, 100 . . . , each term value is $\frac{1}{3}$ the amount of the previous value.

In the Fibonacci (Leonardo Pisano) number series (1, 1, 2, 3, 5, 8, 13, . . .), each number is the sum of the two previous numbers. It is neither arithmetic nor geometric.

Interesting patterns occur in squares, cubic numbers, and triangular numbers, as well as in Fibonacci numbers and fractals. While the patterns are interesting to explore, keep in mind that Grade 7 learning outcomes are limited to linear relations, and do not include powers and exponents. Students may be able to describe recursive relationships in these patterns, but not the explicit rules with relationships that describe the equation of the patterns.

Patterns are all around us, ranging from four legs on a chair to the patterns found in geometry, art, architecture, and music. The lengths and diameters of pipes in a pipe organ provide an example of relationships in pitches and harmonics and different octaves.

Pleasant patterns often correspond to the ratio of the golden mean or rectangle. The patterns in sound waves and light waves are converted to numeric values, and the relationships are used in producing CDs, DVDs, and other digital technology.

Two Types of Relationships in Patterns

Two types of relationships in patterns are recursive and explicit relationships.

- **Recursive relationships:** These relationships explain how each term in the pattern compares or relates to the preceding term in the pattern. They are useful for extending patterns and for completing tables of values. In the pattern $2, 4, 6, \dots$, each successive term value increases by a value of 2. The words, “begin at 2 and add 2 to each term value,” or “the term value plus 2 equals the next term value,” or the expression, “ $t + 2$, where t is the previous term value” all describe the recursive relationship in the pattern. This relationship is limiting when the need arises to determine term values for terms that are not close to those known. It also represents a misuse of the variable t .
- **Explicit relationships (or rule):** These relationships relate the term number to the term value for each term. They are used to predict the n th value in a pattern, and to express the pattern as an equation or formula. The words, “the term number multiplied by 2” describes the explicit relationship in the pattern $2, 4, 6, \dots$. Recall that multiplication is repeated addition; thus, the relationship is also described as, “the term number multiplied by 2,” or “ $2n$, where n is the term number.”

Placing the numbers in a table of values makes it easier to compare the term and term value numbers.

Term number	1	2	3	4
Term value	2	4	6	8

When assessing student performance, keep in mind that Grade 7 learning outcomes are limited to discrete elements and linear relations, and do not include powers and exponents. Students may be able to describe recursive relationships in some geometric patterns, but may not be able to articulate symbolic relations to describe the explicit rules in these patterns. When asking students to represent the pattern algebraically, the expectation is that students will be able to represent the explicit pattern, $2n$.

Representing Patterns and Identifying Relationships

Patterns can be represented in different ways. The recursive and explicit relationships between the elements exist in the different representations of a pattern. Generalizing explicit relationships can be challenging, and may require persistence. Each type of representation provides a different view and a different way to think about the relationships. Encourage students to work toward identifying the relationship in each type of representation. To increase students' ability to think symbolically, begin with more obvious relations and teach students to ask themselves increasingly complex questions about the relations (e.g., What remains the same? What changes? By how much does it change? Is this true for every term in the sequence? How can that idea be represented? What happens if . . . ?).

The following process for representing patterns flows from the concrete or pictorial to the symbolic. It is important to guide students through the process.

- Concrete or pictorial representation:** The context of the pattern exists in the physical pattern itself, and can be represented concretely or pictorially. Students can examine the physical terms to determine what remained the same in each term and what changed. Playing with colour or arrangement of patterns can often help students to see the constant and the changing aspects of a pattern.

Example:

Pictorial representation of a pattern	•••	•• •••	•• •• •••	•• •• •• •••		
---------------------------------------	-----	-----------	-----------------	-----------------------	--	--

In this example, two dots are added to the top of each new term. The term value = the previous term value + 2.

- Charts or tables of values:** Charts or tables of values display numeric representation of the pattern values, and may also be used to record the recursive changes between the terms. These representations, as illustrated in the following example, facilitate numeric comparisons. They can be presented in horizontal or vertical format.

Example:

Term number (n) (the position of the term in the sequence)	1	2	3	4	5	6
Term value (v) (the number of items in the term)	3	5	7	9		

Read the table in one direction (across in the table above) to identify the *recursive relationship* (each term value increases by 2). Read in the opposite direction (down in the table above) to get information about the *explicit relationship*. Ask, “How can the term number be changed to get the term value?” Here, multiply the term number by 2 and add 1. Express the relationship symbolically as the expression,

$$2n + 1 \text{ or equation } 2n + 1 = v,$$

where n = the term number and v = the term value

If the relationships are not evident in the charts or tables, examine the other representations for clues. Students will have an easier time seeing numeric relationships if they have a good grasp of addition and multiplication facts.

- Graphs:** A graph provides a concrete picture of the relationships in the pattern. It provides clear evidence of whether the values are increasing or decreasing, how quickly the change is happening, and the increment of change. Relationships can be described by articulating these changes. Each point on the graph represents an (x, y) pair. Try to express both numbers in terms of the x -value (e.g., $(x, x + 2)$). If the points line up along a 45° incline, the relation may have only a constant (e.g., it has a coefficient of 1). If the incline is steeper, the relation will have a coefficient greater than 1, and it may have a constant. If it is less steep, the relation will have a coefficient less than 1 and greater than zero, and it may have a constant.

Note: In the previous equation, $v = 2n + 1$, and 2 is the coefficient and 1 is the constant.

Example:

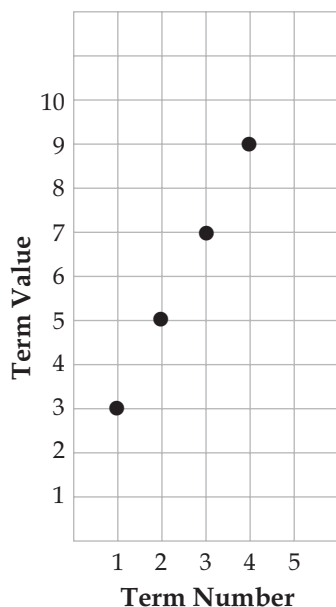

Note:

The Grade 7 learning outcomes deal with discrete data. Since n and v refer specifically to the term number and term value, they are represented by natural numbers (1, 2, 3, 4, . . .). As a result, no line should be drawn through the points.

- In this example, the plotted points lie in a straight line. Therefore, this pattern is a *linear relation*.
- As x increases, so does y . So the pattern is an *increasing linear relation*.

- Evaluating the recursive relationship shows that the value of the first term is 3, and the subsequent terms increase by 2.
- Going to the first term, and then going back one step from the first term, and then removing 2 from the first term value results in 1. Evaluating the explicit term could begin with thinking that something must be added to 1 to equal each term value. In the symbolic relation, + 1 is present in every term. It is referred to as a *constant*. Through experimentation, students can determine that the y -value, when x is zero, represents the constant—this is represented by the place where the relation crosses the y -axis on a graph.
- On the graph, for each increase in 1 horizontally (each increase in 1 by x , or each time the term number increases by 1) the vertical increase is 2 (y increases by 2, or the term value increases by 2). This can be expressed using the relation $2x$, where 2 is referred to as the *numerical coefficient*.
- **Mathematical language (words):** Mathematical language can be used to describe the pattern as it appears in the physical representation, chart, or graph. A clear description of a pattern can help students to recognize the explicit relationship. If students describe a pattern as “increasing by two dots each time,” they may see the recursive relationship. If, however, they can be more descriptive and say, “the pattern starts with three dots, and two dots are added on top each time,” they may begin to notice that there is an explicit relationship.
- **Mathematical symbols:** Mathematical symbols can be used to create expressions, formulas, and equations to represent the relationships. The pattern in the previous table can be represented symbolically by the
 expression $2n + 1$ or equation $2n + 1 = v$,
 where n = the term number and v = the term value

A blackline master for recording these representations is available in BLM 7.PR.1: Patterns: A Process. The process flows from the concrete to the pictorial to the symbolic, and it is important to guide students through it.

The Meaning of Variables

Variables are symbols used to take the place of numbers. Variables provide the ability to express generalizations without any attachment to a specific value. In writing relations, students will gain experience working with all three applications in which variables are used. Understanding the different applications can help reduce confusion over what a variable actually stands for.

Caution:

When using variables in relations, keep in mind the following:

- Any visual can serve as a variable, but it is conventional to use lowercase letters. For example, $2n + 1$ and $2x + 1$ represent the same situation. Both n and x are variables that take the place of whatever number. In earlier grades, students often use pictures or shapes to represent a variable. It is important that students understand mathematical conventions, and regularly use lower case letters for variables.
- Using a variety of variables with students is important. Be careful, however, not to select variables that may be confused with units to represent a scenario where units may be present.
- The variable x is often confused with the multiplication symbol \times . It is appropriate for students to begin representing multiplication using parentheses, $2(x)$, the multiplication dot $2 \cdot x$, or, in its simplified form, $2x$.

Applications in Which Variables Are Used

Variables can be used for the following purposes:

- **To represent a value that changes.** In the preceding example of the chart of values, the variable n represents the term number of the pattern. The term number is a value that changes for each term. The variable n can represent any particular term number, but only one term value for a given term number. Any variable can be chosen to represent the term number (e.g., for the expression $2n + 1$ and for a term number of 3, there can only be one term value, 7).
- **To solve for a specific unknown.** The explicit rule to determine a term value in the above example is $2n + 1$, where n is the term number. Substituting any term number for n and simplifying the expression will reveal the unknown term value for that particular term number n .
- **To simplify an expression.** In the above example, n represents the term number, and $2n + 1$ represents the term value. Together, $(n, 2n + 1)$ represent the x - and y -coordinates used for each term on a graph. The variable y represents the simplified expression $2n + 1$ for each term value ($y = 2n + 1$).

Equations and Expressions

- In the above example, $y = 2x + 1$, the expression, $2x + 1$ represents the term value. The variable y also represents the same term value. The expressions $2x + 1$ and y are different names for the same value. They are equivalent expressions.
- An equal sign ($=$) is used in an equation to show that both expressions represent the same value, $y = 2x + 1$. All equations contain an equal sign between two different representations of the same value.
- Expressions are relations that do not contain an equal sign. They provide only one description of the value referred to. The expression $2x + 1$ represents a value, and y is a separate expression that represents the same value.
- Watch for confusion in students about the use of equal signs. When students see an equal sign, they sometimes interpret it as a direction to do something with the numbers preceding it. They forget the equal sign's role as a symbol of equality. For example, if students see $3 \times 4 = n \cdot 6$, some might think they are being asked to multiply 3×4 , which would result in $n = 12$. If n were 12, the statement would say $3 \times 4 = 12 \cdot 6$ or $12 = 72$, and that is not a true statement.

Variables and Equations

Recall that in the equation, $2x + 3 = y$, 2 is the numerical coefficient, x and y are variables, $+ 3$ is a constant, and the equal sign indicates an equation. Altogether, they represent an equation made up of two equivalent expressions, $2x + 3$ and y .

In previous grades, students model the preservation of equality concretely, pictorially, and orally, and represent and verify equivalent forms of an equation. In Grade 7, students extend this ability to using preservation of equality to solve equations and problems.

Strategies for Solving Linear Equations

Students may apply various strategies, such as the following, to solve linear equations:

- **Use intuition.** Students will be able to solve some linear equations intuitively, by recalling a related arithmetic fact or by recognizing a relation (e.g., doubling, 1 more or less).
- **Substitute a value for a variable.** The substitution is essentially a guess-and-check strategy that is verified through substitution. It is good practice to verify all solutions by substituting the solution for the variable and working through the equation.
- **Graph the equation.** Create a table of values and use a graphical representation of the equation to read the information required. (This strategy is outlined in relation to learning outcome 7.PR.2.)

- **Use counters to model the equation.** This strategy works well for whole numbers. For example, to model $3n = 24$, a student could distribute 24 counters into 3 equal groups and count 8 in each group. To model $3n + 4 = 22$, a student could distribute 22 counters so that there are an equal number in 3 groups and a group of 4 by themselves. There would be 6 in each group of 3, so $n = 6$ in this equation. Students may extend this strategy to working backwards.
- **Work backwards through the equation.** In the previous example, $3n + 4 = 22$, take 22 counters. The last direction in the equation is to add 4, so do the reverse and remove 4, which would leave 18 counters. Some number multiplied by 3 is 18. The opposite of multiplying is dividing, so divide 18 by 3. The result is 6. Take care that students do not misinterpret the equal sign as a direction to do some operation rather than as a symbol that separates equal quantities.
- **Use algebra tiles.** The rectangular tile is used to represent x . The small squares are used to represent units. One colour represents positive integers, and another colour represents negative integers. A vertical rod is used to represent the equal sign. When working with algebra tiles, it is important to be consistent about what each manipulative represents. Different sources sometimes have different representations.

Example:

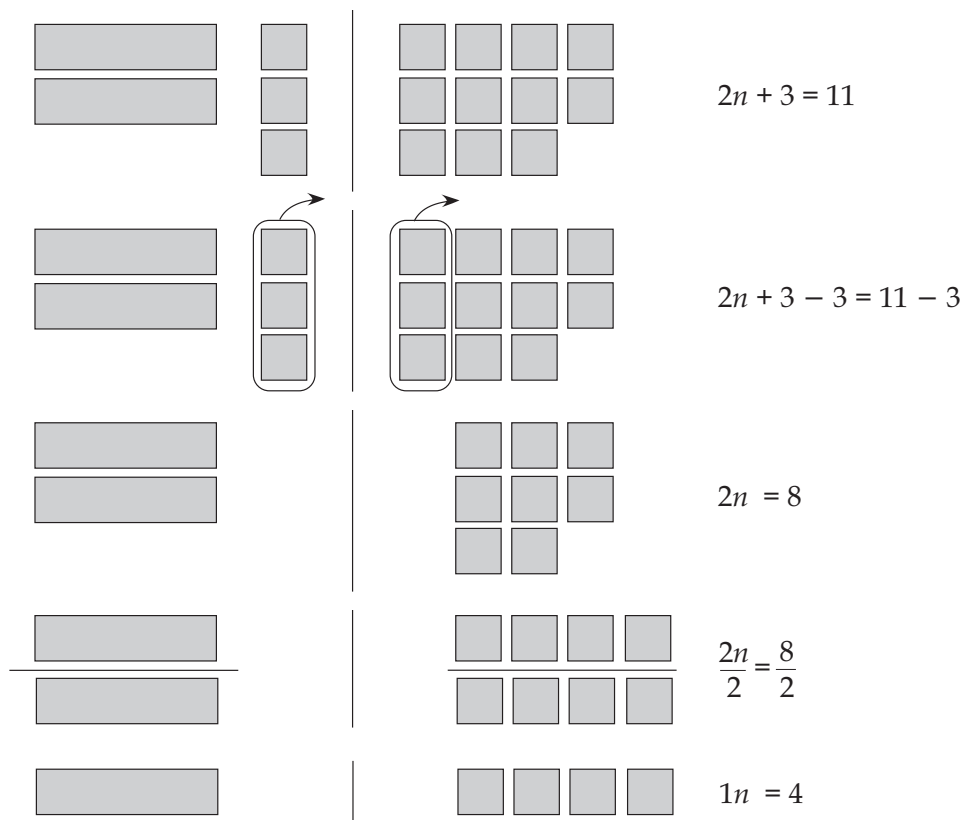

- **Use a balance scale model.** This model is based on the principle that an equation represents two equal expressions separated by an equal sign. The equal sign represents the fulcrum or balance point of a scale, and the expressions on either side represent masses placed in either pan of the balance. The expressions are equal—both represent the same value and can symbolize equal masses.

Example:

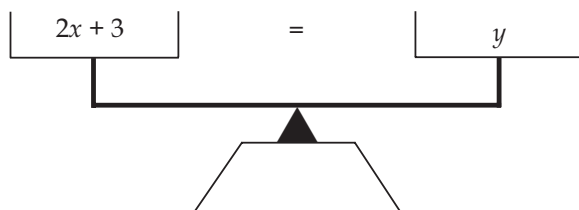

- In the balance scale metaphor, changing the mass on one side of the fulcrum will tip the scale. Making an identical change on the opposite side of the fulcrum will rebalance the scale.
- In the concrete model, a balance scale is used along with identical objects, such as blocks, cubes, or marbles, to represent numbers, and paper bags or polystyrene cups, to represent variables. Designated objects are added to the bags evenly, and identical changes are made to both sides of the scale until balance is achieved. The objects in the bag could be counted to obtain the value of the variable, or the items can be manipulated until one bag is isolated on one side of the scale. The quantity it represents is isolated on the opposite side, and the scale is at equilibrium.
- In the symbolic representation of the model, the equation is solved by performing identical operations on either side of the equal sign, until a variable remains on one side and a value on the other. (This method is developed in the learning experiences suggested for learning outcome 7.PR.3)

Example:

Represent $2n + 3 = 11$ as a balance.

● represents a chip

□ represents a bag containing an unknown number of chips

$$2n + 3 = 11$$

Show this concretely (or pictorially).

$$2n + 3 = 11$$

$$-3 \quad -3$$

Maintaining balance, remove 3 chips from each side.

$$2n = 8$$

Simplify.

$$\frac{2n}{2} = \frac{8}{2}$$

Determine the number of chips that would be in each bag.

$$n = 4$$

Simplify.

$$2n + 3 = 11 \quad (?)$$

$$8 + 3 = 11 \quad (?)$$

$$11 = 11 \quad (\checkmark)$$

Check.

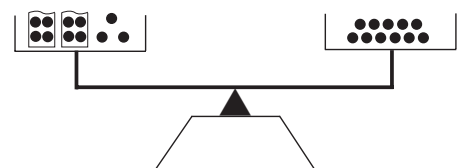
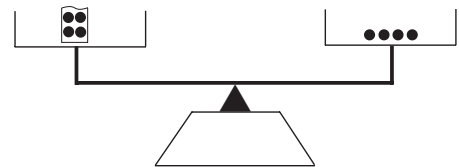
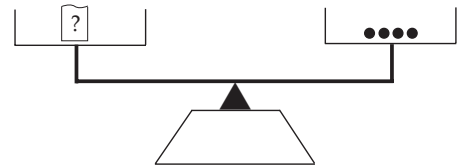
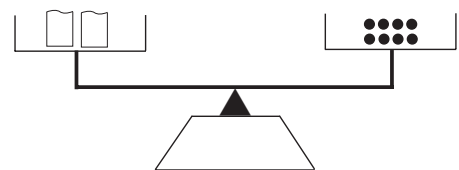
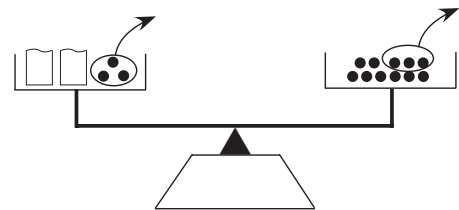
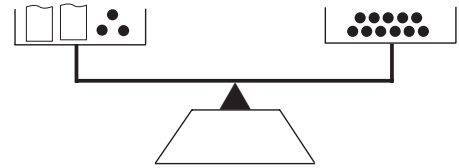
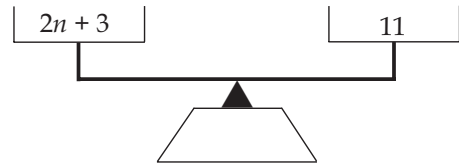

Be sure to arrange learning experiences in such a way that students have ample opportunity to work with a variety of concrete materials when solving linear equations through preservation of equality, to explain the process orally, to represent it pictorially, and to record it symbolically.

The skills students develop in solving linear equations through preservation of equality, and the experience they gain representing patterns and contextual situations as relations and linear equations, can be combined to solve problems with ease.

MATHEMATICAL LANGUAGE

algebraic expression
constant
coordinates
core
element
equation
equivalent
evaluate
explicit relationship
expression
graph
linear relation
numerical coefficient
pattern
recursive relationship
relation
solution
solve
substitution
table of values
term (step number, figure number)
value
variable



Assessing Prior Knowledge

Materials:

- BLM 7.PR.1: Patterns: A Process
- BLM 7.PR.2: Sample Patterns
- demonstration board
- manipulatives (e.g., cubes, pattern blocks)
- grid paper
- math journals or notebooks

Organization: Whole class, individual

Procedure:

1. Introduce the topic of patterns with a class discussion.
 - a) Ask students to share patterns they have seen, or present them with samples of patterns. Ask them to describe the patterns. Ask whether there are other ways to represent the same pattern. Review pattern-related vocabulary as opportunity arises during the discussion.
 - b) Select an example of a pattern from BLM 7.PR.2: Sample Patterns, or use a student example, including three or four terms of a basic growing pattern. Record the example on the demonstration board. Students may build the pattern and/or record it in their math journals or notebooks. (Caution: Avoid a triangular number pattern of adding an additional row one item longer for each term.)
 - c) Have students extend the pattern another three terms. Ask them to share the rule they used for extending the pattern using words, and then using a mathematical expression. Record the recursive rules or relations, and have students do the same.
 - d) Have students complete a chart of the term numbers and term values. Record the chart. Then complete a table of values, with one column being the term number (x), and the other being the term value (the relation to x) or (y).

Note:

This learning experience could be used within a body of evidence to report on the following competency on the Grade 7 Numeracy Assessment:
Student uses number patterns to solve mathematical problems.

Reference:

Manitoba Education and Advanced Learning. *Middle Years Assessment: Grade 7 Mathematics: Support Document for Teachers: English Program*. Winnipeg, MB: Manitoba Education and Advanced Learning, 2015. Available online at www.edu.gov.mb.ca/k12/assess/support/math7/.

e) Transfer the values in the table to a grid plot. Review the coordinate plane, and label the x -axis and y -axis as you do so. Include term number and term value in the labels. Ask students whether the points should be joined.

Note:

Learning outcomes in Grade 7 (and in previous grades) deal with discrete data. Since Grade 7 learning outcomes limit graphing to discrete data, the points should not be connected.

f) Ask students to describe the explicit relationship in words and as a symbolic relation. Discuss strategies used to determine the explicit relationship. For example, evaluating whether the pattern is increasing or decreasing, and by how much, informs students about the operation used in the expression. (For a discussion on Representing Patterns and Identifying Relationships, see the Background Information for learning outcomes 7.PR.1 and 7.PR.2.) Have students record strategy tips.

g) Connect the x - and y -variables to the term number and the term values and to the coordinate points. Write an equation to represent y in terms of x . In the example $(x, 2x + 1)$, $y = 2x + 1$. These terms can be added to the graph labels. (This topic is explored further in a later learning activity about connecting relations to oral and written patterns.)

2. Choose a pattern for students to work with independently. Distribute copies of BLM 7.PR.1: Patterns: A Process and BLM 7.PR.2: Sample Patterns. Ask students to complete the five representations of one or more pattern examples.

Variations:

- Students may choose or create their own pattern to represent in the five ways. Or they may choose or create a pattern for a classmate to represent.
- If students are having difficulty focusing on extending pattern variations, have them begin by using concrete materials to represent the patterns and to extend them.

Observation Checklist

- Listen to and observe students' responses to determine whether students can do the following:
 - Extend a pattern.
 - Create a chart and a table of values representing the pattern.
 - Represent the pattern as a graph, and label the graph.
 - Describe a recursive relationship to represent the pattern with words and with a symbolic expression.
 - Identify the explicit relationship in the pattern as words, and represent it as a symbolic expression and/or an equation.

Suggestions for Instruction

- **Formulate a relation to represent the relationship in an oral or a written pattern.**
- **Provide a context for a relation that represents a pattern.**
- **Identify and provide an example of a constant term, a numerical coefficient, and a variable in an expression and an equation.**
- **Explain what a variable is and how it is used in an expression.**
- **Provide an example of an expression and an equation, and explain how they are similar and different.**
- **Substitute a value for each unknown in an expression and evaluate the expression.**

Materials:

- BLM 7.PR.3: Directions for Playing a Relations Game
- math journals or notebooks

Organization: Whole class, small groups, individual

Procedure:

1. Introduce students to a relations game, such as that found on BLM 7.PR.3: Directions for Playing a Relations Game.
2. Demonstrate the game to the class.
3. Divide the class into small groups and have them play the game.

4. Provide students with the following problems and have them record their responses in their math journals or notebooks:
- Amanda puts a 3 into the function machine and gets out a 7. Use symbols or words to show three different rules the function machine could be following.
 - The function machine continues to use the same rule, but this time, Amanda puts in a 6 and gets out a 13. Use symbols and words to show one rule that you think the function machine is following.
 - The function machine continues to use the same rule. Predict what the output will be if the input is 5. Explain how you know this.



Observation Checklist

- Listen to and observe students' responses to determine whether students can do the following:
 - Predict an element in a pattern based on a pattern rule.
 - Describe a recursive relationship to represent the pattern with words and with a symbolic expression.
 - Identify the explicit relationship in the pattern as words, and represent it as a symbolic expression and/or an equation.

Suggestions for Instruction

- **Formulate a relation to represent the relationship in an oral or a written pattern.**
- **Provide a context for a relation that represents a pattern.**
- **Identify and provide an example of a constant term, a numerical coefficient, and a variable in an expression and an equation.**
- **Explain what a variable is and how it is used in an expression.**
- **Provide an example of an expression and an equation, and explain how they are similar and different.**
- **Substitute a value for each unknown in an expression and evaluate the expression.**

Materials:

- BLM 7.PR.1: Patterns: A Process (completed—from Assessing Prior Knowledge learning activity)
- BLM 7.PR.4: Understanding Concepts in Patterns and Relations
- demonstration board
- Venn diagram (optional)
- textbook glossaries, mathematics dictionaries, and/or other references (optional)

Organization: Pairs, whole class, individual

Procedure:

Part A

1. Activate students' background knowledge about algebra and algebraic terms using a Think-Pair-Share strategy in which students think about a question individually, and then share their ideas, first with a partner and then with the whole class. The following questions and comments are offered as a guide.
 - a) What is algebra?

As students share responses with the class, include the concept that algebra is the language of symbols used to represent the relationships in patterns.
 - b) What are some of the symbols used in algebra and what do they represent?

As opportunity arises during the sharing and during the next steps of the learning activity, develop students' understanding of the following vocabulary terms: *relation*, *variable*, *numerical coefficient*, *constant term*, *expression*, and *equation*. Encourage students to use proper terminology as they explore patterns. Record terms on the demonstration board as they arise.
2. Use students' experiences with relations in patterns to develop the meaning and use of the vocabulary terms *relation* and *variable*. Record terms on the demonstration board as they arise. Have students examine their completed work from the Assessing Prior Knowledge learning activity (BLM 7.PR.1: Patterns: A Process). Some guiding questions and comments are suggested below. Also connect vocabulary terms to visible and familiar contexts.
 - a) **Relation:** Examine the section (on BLM 7.PR.1: Patterns: A Process) where students describe the pattern in their own words, and compare it to the algebraic expression and the equation.
 - Ask students how these are related.

The algebraic statements are symbolic representations of the words used to describe the patterns. The opposite is true as well. The equation gives directions to perform some operation on the term number to come up with the term value. It dictates what to do with the x -value to get the y -value. In a relation, one number in a pair is used to identify the other number, or the related number, in the pair. In the equation $2x = y$, the expression $2x$ relates x to y . The expression $2x$ is a relation. In everyday life, the relation could, for example, describe the number of chairs at each table: $2x = \text{total \# of chairs}$, where $x = \text{the \# of tables}$.
 - Ask students to share their patterns (from BLM 7.PR.1: Patterns: A Process) and identify the matching symbolic relations, and vice versa. Challenge them to generate examples of relations to represent familiar contexts and to provide contexts to match some relations.

b) **Variable:** Students used variables in the expressions that represent the relationships between term numbers and term values and in the algebraic equations.

- Ask students to share which variables they used in their representations, and what the variables represent in each case. Increasing students' awareness of the three different uses for variables may help reduce some of the confusion they may encounter using algebra. This discussion also provides an opportunity to discuss conventions and cautions in choosing symbols. (See the Background Information.) You may wish to have students use a variety of variables to express contextual relationships or to identify possible contexts for a relation (e.g., $4g = s$. 4 students in a group, $4 \cdot \# \text{ of groups} = \text{the } \# \text{ of students}$). Practise substituting values for the variables.

- Point out how the numbers represented by the variable vary or change, depending on which figure of the pattern is being referred to. This is one way variables are used. Different variables in one equation represent quantities of different items. The same variable in one equation always represents quantities of the same thing.
- Replacing a variable with a number in the expression or equation generates the value for the other number. Ask students to generate term values for specific term numbers, by substituting the term number for the variable in the relation. Another way variables are used is to find a particular number. Here, the particular number is represented by a relation.
- Have students examine the graph (on BLM 7.PR.1: Patterns: A Process). How are the x -values and the y -values for each point related? The y -values are expressed in terms of the x -values in the relationship rules. Both axes on the graphs may be labelled in terms of x . Consider the algebraic equations: $y =$ (the relation in terms of x), and y is a simpler name for the change you made to x . A third use for variables is as a simplified name for a relation. Variables can be used to make generalized statements about mathematical relationships, such as $l \times w = \text{Area}$.

Note:

This learning experience could be used within a body of evidence to report on the following competency on the Grade 7 Numeracy Assessment:

Student uses number patterns to solve mathematical problems.

Reference:

Manitoba Education and Advanced Learning. *Middle Years Assessment: Grade 7 Mathematics: Support Document for Teachers: English Program*. Winnipeg, MB: Manitoba Education and Advanced Learning, 2015. Available online at www.edu.gov.mb.ca/k12/assess/support/math7/.

3. Have students work with their partners to practise generating some contextual relations using variables or to match a context to a relation. Practise substituting values in the relations. Reassemble as a class and share a few responses to verify students' understanding.
4. Provide students with copies of BLM 7.PR.4: Understanding Concepts in Patterns and Relations. Ask them to define and provide an example of the terms *variable* and *relation*.

Part B

5. Continue using the work completed in Part A as a reference. Use students' experiences with relations in patterns to review the vocabulary terms *relation* and *variable*, and to develop the meaning and use of the vocabulary terms *expression*, *equation*, *constant term*, and *numerical coefficient*. Record each term on the demonstration board as it arises. Some guiding questions and comments follow.
 - a) **Expressions and equations:** The previous discussion about *expressions* and *equations* in relations provided some background experience with these terms. Now, compare and differentiate the terms *expressions* and *equations*. Expressions contain variables and operations that represent one name for a value. There is no equal sign in an expression. An equation contains two expressions that are equal to each other. Students commonly misunderstand the equal sign as a directive. (Refer to the discussion regarding expressions and equations in relations in Part A of this learning experience and to the Background Information.)
 - b) **Constant term:** A representation of the constant term is readily seen on a graph by examining the point at which the relation meets the y -axis ($x = 0$). It shows what quantity is at the base of each step in the pattern, and, therefore, must be added (or subtracted) each time you calculate a term value. Constant terms are separated from variables with an addition or a subtraction symbol. Ask students to identify constant terms in any of their relations.
 - c) **Numerical coefficient:** In some patterns, the term number (variable) is multiplied by the same amount in each term. Ask students to identify a numerical coefficient for any of the variables in their relations. The slope of the line in the graphical representation of patterns provides a clue to the presence of a coefficient in a relation. Discuss conventions of notation.
6. Provide several examples of relations in words, expressions, and equations, or have students create their own examples. Have students work with their partners to identify relations, variables, numerical coefficients, constant terms, expressions, and equations in the examples, and substitute values for the variables. Verify the accuracy of students' responses.
7. Provide students with copies of BLM 7.PR.4: Understanding Concepts in Patterns and Relations or a Venn diagram. Ask them to define and provide an example of each of the following terms: *expression*, *equation*, *constant term*, and *numerical coefficient*. If you choose to use the Venn diagram, ask students to compare *expression* with *equation* and *constant term* with *numerical coefficient*.

Variations:

- Have students create and/or complete crossword puzzles of the vocabulary terms.
- Have students create a beginning algebra booklet, including the terms, definitions, and examples. This booklet could be used as an appendix for another booklet idea in a culminating learning activity.



Observation Checklist

- Listen to and observe students' responses to determine whether students can do the following:
 - Formulate a relation to represent the relationship in an oral or written pattern.
 - Provide a context for a relation that represents a pattern.
 - Identify and provide an example of a constant term, a numerical coefficient, and a variable in an expression and an equation.
 - Explain what a variable is and how it is used in an expression.
 - Provide an example of an expression and an equation, and explain how they are similar and different.
 - Substitute a value for each unknown in an expression and evaluate the expression.

Suggestions for Instruction

- **Formulate a relation to represent the relationship in an oral or a written pattern.**
- **Provide a context for a relation that represents a pattern.**
- **Identify and provide an example of a constant term, a numerical coefficient, and a variable in an expression and an equation.**
- **Explain what a variable is and how it is used in an expression.**
- **Provide an example of an expression and an equation, and explain how they are similar and different.**
- **Substitute a value for each unknown in an expression and evaluate the expression.**

Materials:

- BLM 7.PR.5: Possible Word Pattern Contexts to Match a Relation
- BLM 7.PR.6: Formulating Relations to Match Word Descriptions of Patterns
- demonstration board
- card stock (optional)

Organization: Whole class, individual

Procedure:

Remind students, as noted in the previous learning activity, that patterns are represented in many equivalent forms. The pattern can be recognized in each of the forms, and one form can be translated into another. Each different representation provides a different view of the same pattern. The more views students see, the greater their understanding of the pattern will be. A word description of the pattern can be used to make a physical representation of the pattern, as well as a chart, a table of values, and/or a graph.

The x - and y -values of the graph are also represented in the word description of the pattern, and can be used to form an algebraic equation.

Part A

1. Help students establish a process of writing a relation to match a word description of a pattern or context by working backwards from a relation.
 - a) Begin by analyzing a relation such as $x + 1 = y$. Dissect the terms of the relation and identify their symbolism. There are two expressions: $x + 1$ and y . The equation tells us that the two expressions are equal to each other. There are two variables: x represents some number of things and y is a number of other things. There is one operation, a constant term of $+ 1$. Together, the two expressions indicate that there is one more y thing than there are x things. To find the number of y things there are, use the quantity that x represents and add 1.

Note:

This learning experience could be used within a body of evidence to report on the following competency on the Grade 7 Numeracy Assessment:
Student uses number patterns to solve mathematical problems.

Reference:

Manitoba Education and Advanced Learning. *Middle Years Assessment: Grade 7 Mathematics: Support Document for Teachers: English Program*. Winnipeg, MB: Manitoba Education and Advanced Learning, 2015. Available online at www.edu.gov.mb.ca/k12/assess/support/math7/.

Note:

The variables x and y are used throughout this learning activity to reinforce the connection of variables to term number charts and/or term value charts and the graphical representations of patterns on a coordinate grid. If you wish, emphasize that any symbol or name can be used to represent the variable, or develop that concept in a later learning activity.

- b) Create a possible context or situation that this relation could represent. Imagine something of which x could be a quantity. The constant will be an unchanging quantity of that same thing, and y will be the combined quantity.

Example 1:

The relation could represent people: the number of guests attending your party (x), you, who will be there no matter what ($+ 1$), and the total number of people at your party (y). Substitute some values for x , and solve the equation to get values for y . Consider whether or not the values make sense in relation to each other. If not, something needs fixing. For example, if 3 people come $+ 1$ (you), there will be 4 people at the party. That is reasonable. Reinforce that $x + 1$ is an expression that tells us how to find the value of y . In this example, $x + 1$ is one name for the number of people at the party. And the number y represents another name for the number of people at the party. So, $x + 1$ and y represent the same number. They are equal. The two expressions are combined as the equation $x + 1 = y$.

Example 2:

The relation could represent money: the number of dollars you decide to take from your piggy bank (x), the one-dollar coupon you have ($+ 1$), and the dollars you can spend at the restaurant (y). Verify the relation through substitution. If you withdraw \$10 and add the \$1, you will have \$11. That is reasonable.

2. Complete a few examples of different relations together with students. Also include examples where $x = y$, and where y decreases as x increases. Have students independently create possible word situations to match a particular relation. BLM 7.PR.5: Possible Word Pattern Contexts to Match a Relation provides a framework for recording these. You may wish to assign the relations, or students may create their own. Remind students to substitute values to verify the reasonableness of their relations. After allowing sufficient time for individual work, have students share some context and relation matches with the class so you can verify their understanding. Assign more independent or partner practice if it seems beneficial.

Part B

3. Reassemble as a class, and establish a procedure to reverse the above process, enabling students to formulate a relation to match the word description of a pattern. Do this by analyzing the word description of the pattern to find parts to represent x , y , and constants or numerical coefficients. Combine the parts to write a matching symbolic relation. A chart such as the following can serve as an organizational tool.

Writing a Symbolic Relation		
One quantity that can be represented by a variable (similar to the term number) Represent with x	An operation that tells what to do to x (the term number) to get y (the term value) Record as a constant (+ or -) or numerical coefficient (\times or \div)	A quantity that will be represented by the y -variable (similar to the term value) Represent with y

4. Illustrate how to analyze the description and find the parts to represent x , y , and constants or numerical coefficients by using examples such as the following:

Example 1:

A girl owns three horses. She purchases more horses at an auction; consequently, she now has more horses.

- Look for some quantity that acts like a term number, in that it can change in a step-by-step fashion. That number will be represented by the x -variable. The girl may buy 1, or 2, or 3, or 4, or . . . horses. In this case, the x -variable will be the number of horses she buys.
- Next, identify which quantity will be represented by the y -variable. This is similar to a term value. The term value depends on the term number. The number of horses she ends up with depends on how many she buys, so the y -variable will be the number of horses she ends up with.
- Then, consider the presence of a constant or a numerical coefficient. If there is a quantity to start with, or one to remove at the end, there will be a constant to add or subtract. If a variable is being multiplied or divided, there will be a numerical coefficient to connect to the variable. In this example, the girl starts with three horses. She has three horses no matter how many she buys. These three horses are represented by the constant + 3.
- Put the pieces together in the relation $x + 3 = y$. Reinforce this is an equation. It contains two equal expressions. Note the convention to place the variable first and the constant after. Establish these conventions as examples arise.

Example 2:

A boy sells hats at the fair for \$5 each. He pays \$25 for a daily vendor licence. At the end, he has some money. The number of hats sold could be 1, or 2, or 3, or 4, or The number of hats sold will be represented by the x -variable (term number). In the end, the boy will have made some money. That amount of money is represented by the y -variable. He will receive \$5 for each hat he sells. To find out how much money he receives, multiply the number of hats sold by \$5. So, \$5 is the numerical coefficient. Five times the number of hats equals the money received ($5x$). The boy must pay the \$25 fee, no matter how many hats he sells. That will be the constant ($-\$25$). The money he ends up with will be the y -value. The relation is $5x - 25 = y$.

5. As a class, complete a few examples of different relations. Include examples where $x = y$, where there are numerical coefficients, and where there are positive and negative constants.
6. Distribute copies of BLM 7.PR.6: Formulating Relations to Match Word Descriptions of Patterns. Have students individually analyze word descriptions of patterns to formulate relations. After giving students sufficient time to formulate relations, have them use their relations to represent the contexts. Verify their understanding, and assign more independent practice if it seems beneficial.

Variation:

- Use cards or a master sheet of pattern descriptions and relations to conduct a quiz game such as Relation Baseball. Read a pattern description or a relation, and have a student respond with either a matching relation or a pattern description. (For directions on, and variations of, playing a similar baseball game, refer to the Assessing Prior Knowledge suggestion for learning outcome 7.N.6.)



Observation Checklist

- Listen to and observe students' responses to determine whether students can do the following:
 - Formulate a relation to represent the relationship in an oral or written pattern.
 - Provide a context for a relation that represents a pattern.
 - Identify and provide an example of a constant term, a numerical coefficient, and a variable in an expression and an equation.
 - Explain what a variable is and how it is used in an expression.
 - Provide an example of an expression and an equation, and explain how they are similar and different.
 - Substitute a value for each unknown in an expression and evaluate the expression.

Suggestions for Instruction

- **Formulate a relation to represent the relationship in an oral or a written pattern.**
- **Provide a context for a relation that represents a pattern.**
- **Represent a pattern in the environment using a relation.**
- **Identify and provide an example of a constant term, a numerical coefficient, and a variable in an expression and an equation.**
- **Explain what a variable is and how it is used in an expression.**
- **Provide an example of an expression and an equation, and explain how they are similar and different.**
- **Substitute a value for each unknown in an expression and evaluate the expression.**

Materials:

- a list of word descriptions of patterns for which students can formulate relations or word cards from previous learning activity (optional)
- math journals or notebooks
- three-column charts for recording relations and descriptions

Organization: Whole class, individual, small group

Procedure:

For this learning activity, have students act as detectives, with the goal of uncovering the relations that represent word descriptions of patterns.

1. Together with students, develop a strategy for finding clues from which to form the relations. Working through examples may be helpful.

Suggested Strategies:

- Uncover clues that would indicate a term number or a term value.
 - Use the variable x to represent the numeric value of the term number.
 - Use y to represent the numeric value of the term value.

Note:

This learning experience could be used within a body of evidence to report on the following competency on the Grade 7 Numeracy Assessment:

Student uses number patterns to solve mathematical problems.

Reference:

Manitoba Education and Advanced Learning. *Middle Years Assessment: Grade 7 Mathematics: Support Document for Teachers: English Program*. Winnipeg, MB: Manitoba Education and Advanced Learning, 2015. Available online at www.edu.gov.mb.ca/k12/assess/support/math7/.

- Uncover directions about how to find the term value from the term number. Is the operation applied addition, subtraction, multiplication, or division, or a combination of operations?
 - Use a constant term to represent addition or subtraction.
 - Use a numerical coefficient to represent multiplication or division.
2. Work through some examples together with students. Include contexts with various constants and numerical coefficients, and combinations of them.

Example 1:

Determine the number of traffic lights if there is one red light for every green light.

Clues:

- There are two objects that can be quantified. Each can be represented by a variable.
 - Let r represent the number of red lights.
 - Let g represent the number of green lights.
- The number of green lights is the same as the number of red lights.
 - There are no constants or numerical coefficients.

Relation: $r = g$

Example 2:

Determine the number of girls and boys in a class if there are two more girls than boys.

Clues:

- There are two terms to quantify, boys and girls.
- There are two more girls than boys. This clue is important to ensure the operation is performed on the correct variable.
- There are more girls than boys, so the number of boys $+ 2 =$ the number of girls.
 - The number of boys acts as the term number. So b represents the number of boys.
 - The number of girls depends on the number of boys. The number of girls acts as the term value, so g represents the number of girls.
- The expression $b + 2$ results in the number of girls when there are b number of boys.

Relation: $b + 2 = g$

Example 3:

Determine the number of wheels present in a collection of cars if each car has four wheels.

Clues:

- There are two terms to quantify, the number of cars and the number of wheels.
 - Let x represent the number of cars.
 - Let y represent the number of wheels.
- Every car has four wheels.
 - Multiply the number of cars by 4.
 - 4 is the coefficient for x .

Relation: $4x = y$

Use the above examples as an opportunity to discuss conventions such as writing $4x$, rather than $x \times 4$ or $x \cdot 4$, to avoid confusing variables and multiplication signs.

3. After working through several examples as a group, have students describe, in their math journals or notebooks, a strategy for finding a relation to match the description of a pattern.
4. Have pairs of students take turns doing the following:
 - **Student A:** Describe a context in which patterns are found and record it in the middle column of a three-column chart. Then record the relation to the pattern context description in the first column, cover it (or fold it so that the relation is hidden), and pass the chart to Student B.

Example:

Relation (Student A)	Pattern Context Description	Relation (Student B)
Find the total number of ties (t) in a section (s). $t = s + 1$	A railroad track leaves 1435 mm between railway ties. The first 1435 mm section has two ties, and each 1435 mm section after that adds one more tie.	

- **Student B:** Write the relation for the pattern context description in the third column of the chart.

Example:

	Pattern Context Description	Relation (Student B)
	A railroad track leaves 1435 mm between railway ties. The first 1435 mm section has two ties, and each 1435 mm section after that adds one more tie.	Let y represent each 1435 mm section. $y + 1$

5. Students compare the relations they formulated to the answer keys, and discuss and resolve any discrepancies. They test the relations by substituting the variable and evaluating the expression. They verify that the relations make sense when compared to the descriptions.



Observation Checklist

- Listen to and observe students' responses to determine whether students can do the following:
 - Formulate a relation to represent the relationship in an oral or a written pattern.
 - Provide a context for a relation that represents a pattern.
 - Represent a pattern in the environment using a relation.
 - Identify and provide an example of a constant term, a numerical coefficient, and a variable in an expression and an equation.
 - Explain what a variable is and how it is used in an expression.
 - Provide an example of an expression and an equation, and explain how they are similar and different.
 - Substitute a value for each unknown in an expression and evaluate the expression.

Suggestions for Instruction

- **Formulate a relation to represent the relationship in an oral or a written pattern.**
- **Provide a context for a relation that represents a pattern.**
- **Represent a pattern in the environment using a relation.**
- **Identify and provide an example of a constant term, a numerical coefficient, and a variable in an expression and an equation.**
- **Substitute a value for each unknown in an expression and evaluate the expression.**

Materials:

- BLM 7.PR.7: Creating Word Descriptions of Patterns and Matching Relations

Organization: Individuals or pairs

Procedure:

1. As in the previous learning activities, review the concept that patterns have multiple representations and one representation can be used to formulate another. In this learning activity, students will find patterns in their surroundings and then represent the patterns as relations to play an I Spy game. They will need to substitute values and evaluate expressions to find the patterns represented by the relations.
2. Distribute copies of BLM 7.PR.7: Creating Word Descriptions of Patterns and Matching Relations. Have students survey the classroom to identify patterns they could represent using relations, and complete the chart provided on the BLM. Examples could include patterns in furniture, brick, tile, decoration, clothing, supplies, and so on.

Note:

This learning experience could be used within a body of evidence to report on the following competency on the Grade 7 Numeracy Assessment:
Student uses number patterns to solve mathematical problems.

Reference:

Manitoba Education and Advanced Learning. *Middle Years Assessment: Grade 7 Mathematics: Support Document for Teachers: English Program*. Winnipeg, MB: Manitoba Education and Advanced Learning, 2015. Available online at www.edu.gov.mb.ca/k12/assess/support/math7/.

3. Decide who will be the first student to offer a relation. That student says, "I spy a pattern that is represented with the relation _____. Can you guess what I see?" Other students will need to look for a pattern they think matches the relation. Then substitute a value for the variable, and evaluate the expression to ensure students' suggested pattern matches the relation. If individuals have a match, they raise a hand, and, when called upon, offer their suggestion to the one who spies. Students substantiate their proposal by substituting a value, evaluating the expression to verify x and y . If someone is correct, she or he becomes the one who spies, and offers a relation to the group. Choosing variables that begin with the first letter of the objects in the pattern makes the game easier.

Variations:

- To increase participation, play in small groups rather than in a large group.
- Change the environment by taking students to a new area indoors or outdoors to play the game.
- To limit the options, prepare a list of scenarios, and have students spy from the list.



Observation Checklist

- Listen to and observe students' responses to determine whether students can do the following:
 - Represent a pattern in the environment using a relation.
 - Formulate a relation to represent the relationship in an oral or a written pattern.
 - Provide a context for a relation that represents a pattern.
 - Identify and provide an example of a constant term, a numerical coefficient, and a variable in an expression and an equation.
 - Substitute a value for each unknown in an expression and evaluate the expression.
 - Communicate mathematically.

Suggestions for Instruction

- **Create a table of values for a relation by substituting values for the variable.**
- **Create a table of values using a relation, and graph the table of values (limited to discrete elements).**
- **Match a set of relations to a set of graphs.**
- **Match a set of graphs to a set of relations.**
- **Substitute a value for each unknown in an expression and evaluate the expression.**

Materials:

- math journals or notebooks
- pens or markers of different colours
- demonstration board
- examples of relations (These can be teacher-generated or created in previous learning activities, such as completed BLMs, cards, or lists.)
- a selection of the following:
 - grid paper
 - templates for tables of values
 - cards with grids printed on them
 - cards with blank tables of values
 - blank cards
 - scissors and glue or tape
- display board
- graphing software or graphing calculators (optional)

Organization: Individuals or pairs, whole class

Procedure:

The procedure suggested for this learning activity (Part A) will be continued in the next two learning activities (Part B and Part C).

Part A

Present a progression of relations for students to work with, beginning with $x - 2$, followed by $2x$, then $2x - 2$, and then $2(x - 1)$. The following procedure uses $2(x - 1)$ as an example. You may prefer to use relations with addition, such as $(x + 2)$, $2x$, $2x + 2$, and $2(x + 1)$.

1. Present students with a sample relation such as the coordinate pair $(x, 2(x - 1))$ or the equation $2(x - 1) = y$. Challenge students to represent the relation as a graph in their math journals or notebooks, and to record the steps they followed to do so. If or when it seems appropriate, note that the relation is equivalent to $2x - 2$.
2. When students have had sufficient time to work individually, reassemble as a class and ask students to share their ideas about how to go about representing a relation as a graph. As students offer suggestions, record the process on the demonstration board. Ask guiding questions, and supply prompts to ensure the process is complete and understood. Suggest students make adjustments to their math journal entries as the discussion reveals steps they had not considered previously. Making additions in a different colour highlights for you and for students what students are learning during the sharing.

Steps to Include:

- a) Create a table of values.
- b) The x -value is similar to a term number, as shown in previous work with representing patterns. Supply data for the table by substituting values for the variable. Any number may be used to represent x , but beginning with a small number, and increasing in a consecutive fashion by even increments, will generate numbers that are most helpful for viewing relationships. If your class is

$2(x - 1) = y$	
x -value	y -value $2(x - 1)$
1	0
2	2
3	4
4	6
5	8

familiar with adding and subtracting negative numbers (see learning outcome 7.N.6), include negative values, because integers appear in everyday situations involving money, depth below sea level or underground, lost time, and so on. Avoid using negative numbers with numerical coefficients, as multiplying integers is a Grade 8 learning outcome. Solving the expression with a particular x -value will generate a value equivalent to y . This is the value referred to as the term value in previous work. The relation $2(x - 1)$ explains the relation between x and y . Evaluating the relation generates the y -value.

- c) Examine the range of numbers in the table of values and select an appropriate scale for the x - and y -axes. Draw and label the axes with x below the grid, and the relation that names y along the y -axis. Write numbers to indicate the scale of each axis. Remind students to align the centre of the numbers with the grid lines. If students are familiar with the four quadrants of the Cartesian plane (learning outcome 7.SS.4), they will be able to represent values with negative integers. Include a title for the graph. In this case, the graph represents the relation between x and $2(x - 1)$, so that is an appropriate title.

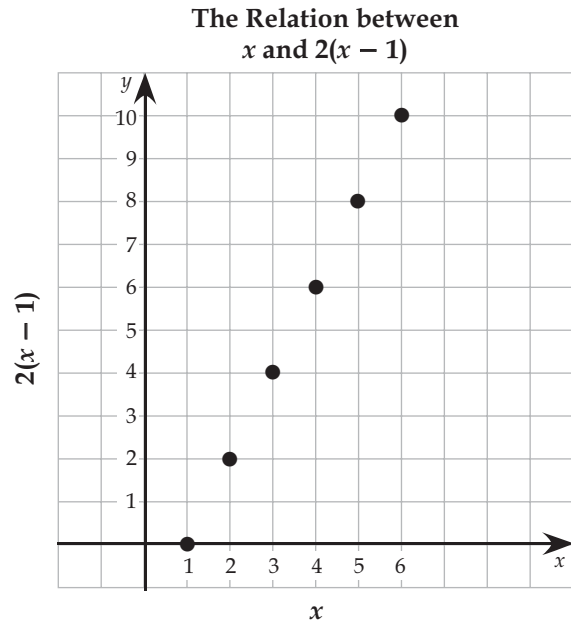

- d) Plot the coordinate pairs on the graph. Since Grade 7 learning outcomes limit graphing to discrete data, the points should not be connected.
- Distribute grid paper, templates for tables of values, and blank cards for writing the titles of the graphs. Students will use these supplies to create an interactive display. Assign relations to students, or have them create their own, or use previously generated relations. Ask students to create tables of values, as well as graphs to represent the relations. Remind students to choose appropriate scales and to label the axes.
 - Have students share their completed graphs. Verify their correctness. Then mount the graphs on the display board and distribute the table of values and the labels. Have students attach the pieces to the matching graphs on the display board. Students may have difficulty matching some labels. The next learning activity (Part B) provides strategies to make matching easier. Alternately, the tables and titles can be mounted, and students can match the corresponding graph. Leave room in the display for descriptions that will be made in the following learning activities (Part B and Part C).

Variations:

- Control the complexity and variety of relations by assigning specific relations to students. Work with one-step linear equations (e.g., $3x$ or $x + 1$), before moving to two-step linear equations (e.g., $2x - 2$ or $\frac{1}{3}x + 1$).
- If students made cards with matching relations and word descriptions of patterns in a previous learning activity, they could add to their card sets by creating matching tables of values cards and graphs.
- The teacher or students can use computer software to generate the tables and graphs to represent particular relations. Have students find matches either in hard copies or electronically, if the technical skills and software are available.
- If the technology and know-how are available, students can use graphing calculators to investigate relations and see what types of graphs the relations produce.



Observation Checklist

- Listen to and observe students' responses to determine whether students can do the following:
 - Create a table of values for a relation by substituting values for the variable.
 - Create a table of values using a relation and graph the table of values (limited to discrete elements).
 - Match a set of relations to a set of graphs.
 - Match a set of graphs to a set of relations.
 - Substitute a value for each unknown in an expression and evaluate the expression.
 - Reason mathematically in order to make mathematical connections.

Suggestions for Instruction

- **Sketch the graph from a table of values created for a relation, and describe the patterns found in the graph to draw conclusions (e.g., graph the relationship between n and $2n + 3$).**
- **Describe the relationship shown on a graph using everyday language in spoken or written form to solve problems.**

Materials:

- math journals or notebooks
- pens or markers of different colours
- demonstration board
- tables of values, graphs, labels, and relations from the previous learning experience
- cards for recording descriptions of graphs (blank file cards or the type of cards used in previous learning experiences)
- display board

Organization: Individual or pairs, whole class

Procedure:

Part B

This is a continuation of the previous learning activity. Students use the products created in Part A and extend their prior knowledge of graphical representations of patterns to describe the relationships shown in a graph and in expressions and equations. Describe the relationships in each of the graphs from Part A: $(x - 2)$, $(2x)$, $(2x - 2)$, and $2(x - 1)$. The following procedure uses the graph for $2(x - 1)$ as an example.

1. Have students examine the sample graphs they created in the previous learning activity (Part A). Challenge students to decipher the coded information the graphs contain about the relationship between x and $2(x - 1)$, and to write their discoveries in their math journals or notebooks.
2. After students have had sufficient time to work on their own or with a partner, reassemble as a class to debrief. Have students share their interpretations of their graphs, and add pertinent information to their math journals. Making additions in a different colour highlights what students are learning during discussion with others. Below are some comments you may wish to include in the discussion. (For additional information about graphs, see Representing Patterns and Identifying Relationships in the Background Information for learning outcomes 7.PR.1 and 7.PR.2.)

Discussion Ideas:

- **Linear relation:** All the points on the graph lie in a straight line. Verify this by placing a ruler along the points. When all the coordinate pairs of a relation lie in a straight line, the relation is called a *linear relation*.

- **Increasing linear relation:** The line goes up to the right. As the x -value increases, the y -value increases as well. The graph tells us that as we get more of whatever x represents, we will also get more of whatever y represents. The relation is described as an *increasing linear relation*.
 - **Recursive relation in words and symbols:** A graph tells us how much the increase will be. The incremental steps from one point in the graph to the next may be described as “move one to the right and move up two.” In this relation, for every additional x , there will be two additional y s. Each time x increases by 1, $2(x - 1)$ or y increases by 2.
 - **Explicit relation:** The explicit relation is also shown in the graph if we wish to decipher it.
 - **Constant in the explicit relation:** If the line on which the points lie is followed backwards to the y -axis, we will notice that the y -value, when the relation hits the y -axis, is -2 . When we use the distributive property to expand $2(x - 1)$ to $2x - 2$, we can see where the -2 is present in the linear relation. This -2 is referred to as the *constant*.
 - **Numerical coefficient in the explicit relation:** The slope, or incline, of the line upon which the points lie indicates there is also a small numerical coefficient in this term. It can be discovered in a variety of ways. For example, by examining the graph, we can see that for every increase of 1 in the x direction, there is an increase of 2 in the y -direction. This is represented by the coefficient in the relation, 2 ($2(x - 1)$).
 - **Complete explicit relation:** The explicit relation contains $2x$ and -2 . The combined explicit relation for the pattern is $2x - 2$, or the equation $2x - 2 = y$.
 - **Equivalent expressions:** The graph shows $2(x - 1)$ and $2x - 2$ are equivalent expressions. This provides an opportunity to talk about equations being two expressions for the same value, and to review the distributive property of multiplication.
 - **Obtaining values that are not plotted:** Extending the line upon which the points lie, or looking at points between the ones that are plotted, and then reading the coordinate pairs, provides information about values that are not listed in a table of values, and provides answers to questions based on the relation.
3. Ask students to identify some contexts that may be represented by linear relations that increase in value. Examples may include the purchase of multiple single-priced items (e.g., bottles of water at \$2 per bottle), a quantity discount (e.g., the first item costs \$3 and each additional item costs \$2), money earned for hours of babysitting, distance travelled in relation to time, volume of drink required in relation to number of people being served, and so on.
 4. Illustrate, or have students graph, a decreasing linear relation where the points lie in a line that goes down as you move to the right. Each time x increases in this relation, the y -value decreases (e.g., $6 - x$, $20 - 2x$). This time, the graph indicates there is an initial quantity that decreases in relation to the x -value.

5. Generate some contexts to represent decreasing linear relations. Examples could include a certain amount of savings in relation to the amount spent at a regular rate, a quantity of items in relation to the quantity used at a regular rate (e.g., There are 20 cans of cat food in the cupboard. The cat eats 2 cans every day), and so on.

Variations:

- Have students work independently or in pairs to write descriptions of the graphs they created in the previous learning activity (Part A). Record descriptions on cards, using both everyday language and algebraic language. Circulate within the class to verify students are on the right track. When the cards are complete, post the relations, the tables of values, the graphs, and the descriptions on the display board. Having students post complete sets of their own work provides an assessment opportunity. Later, one or more individual parts of the display may be distributed among students, and reassembled with the correct matches.
- Play a version of the game Pictionary. One student illustrates a graph and the others guess the matching relation or description.
- Have students explore the relationships between relations and their representative graphs through an inquiry activity. Students create a list of relations that differ in a systematic way (e.g., increasing coefficients, constants, or negative constants). They make graphical representations of the relations, compare the two, and describe the changes. The generalized descriptions may be used to draw conclusions about the relationship between a relation and its representative graph.



Observation Checklist

- Listen to and observe students' responses to determine whether students can do the following:
 - Sketch the graph from a table of values created for a relation, and describe the patterns found in the graph to draw conclusions (e.g., graph the relationship between n and $2n + 3$).
 - Describe the relationship shown on a graph using everyday language in spoken or written form to solve problems.
 - Match a set of relations to a set of graphs.
 - Match a set of graphs to a set of relations.
 - Reason mathematically in order to make connections.

Suggestions for Instruction

- **Sketch the graph from a table of values created for a relation, and describe the patterns found in the graph to draw conclusions (e.g., graph the relationship between n and $2n + 3$).**
- **Describe the relationship shown on a graph using everyday language in spoken or written form to solve problems.**

Materials:

- BLM 7.PR.8: Template for Creating and Solving Problems Using Information from a Graph
- index cards or card stock
- a set of contextual problems and sketches of graphs that represent relations portrayed in the problems (optional)
- student-generated graphs from the previous two learning activities (Part A and Part B) (optional)
- graphing technology (optional)

Organization: Individual or pairs, whole class, individual

Procedure:

Part C

This learning activity may be used as a continuation of the previous two learning activities (Part A and Part B), or conducted as a single learning experience. Students may use the graphs they made previously or create new graphs.

1. Review descriptions of graphs by having students work independently or in pairs to generate contexts or situations that result in increasing or decreasing linear relations. Having students make rough graphical sketches of the relations will reinforce the connection between the descriptions and the graphs. After giving students sufficient time to work on their own or with a partner, have students share examples with the class. Verify students' understanding by evaluating their examples or by conducting a quick matching game. Display a number of sketched graphs. Read a problem and have students select the graph that represents the problem.

2. Model how a graph that illustrates a contextual situation can be used to solve problems. Present a graph such as the following.

Example:

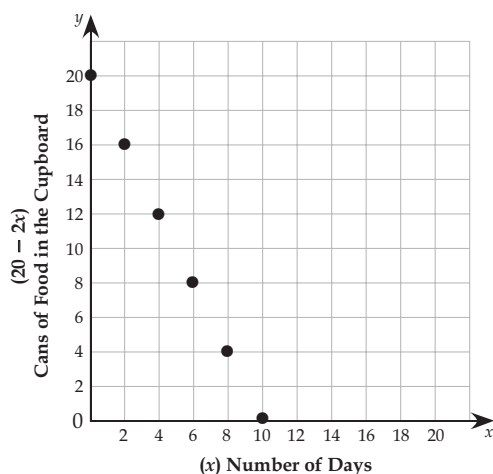

Say that this graph represents the story of a cat and her food. The title indicates that the graph tells the part of the story related to how much cat food is in the cupboard each day. The labels on the axes of the graph tell us that x represents the number of days, and y represents the numbers of cans of cat food. The story begins with a number of cans of cat food in the cupboard. The points lie on a line, so the relation is linear. Therefore, the change will be constant. The line is going down to the right, so the relation is decreasing. We can, therefore, conclude there are fewer cans each day. Likely this is because the cat is eating the food.

We can find out exactly how many cans the cat is eating each day by looking for the recursive relationship in the graph. Each day, there are 2 fewer cans, so the recursive relation is -2 . We can conclude that the cat eats 2 cans of food each day ($-2x$). We can find out how many cans are in the cupboard on any given day by reading the coordinate pairs. For example, on day eight, the corresponding y -value is 4. There are 4 cans of food in the cupboard on the eighth day.

Have students generate a list of questions that could be answered using this graph as a source of information (e.g., How many cans are in the cupboard to begin with? How many cans are left on the __th day? On which day will the cat run out of food if no more is added to the cupboard?).

We can also find the explicit relationship in the graph. The graph begins at 20 and decreases by 2 each day. The equation $20 - 2x = y$ can be used to answer any of the questions as well, by substituting values for a variable and solving the equation. (This will be the focus of subsequent learning activities.)

3. Next, have students use their own graphs to create word problems to share with classmates. BLM 7.PR.8: Template for Creating and Solving Problems Using Information from a Graph may be used as a template for this purpose, and for assessing students' work. Have students choose a graph from the ones they created in the previous two learning activities (Part A and Part B), or have them create a new graph. The new graph may be generated from a table of values that was obtained by substituting values for x in a given relation.

The following steps are recommended:

- a) Identify a story context.
 - b) Become specific about the story and write a title for the graph.
 - c) Label the x - and y -axes.
 - d) Describe the graph.
 - e) Identify the recursive relationship.
 - f) Identify the explicit relation.
 - g) List questions that could be answered by using the graph as a source of information, and state the answers.
4. Ask students to choose one or more of the questions from their list and write interesting word problems that can be solved using their graph as a source of information. Have them write a good copy of the problems on one side of index cards, and the solutions to the problems on the back of the cards, or under a flap, or on whatever medium has been chosen.
 5. Students may wish to verify their work before displaying the problems.
 6. Have students share their problems, and the matching graphs, title, and labels, for their classmates to practise answering. The questions may be presented to the entire class, distributed among small groups, or posted with the matching graphs.

Variations:

- Use technology to create graphs and matching word problems, for presentation or as interactive questions.
- Problem cards may be combined with the other sets to play games (e.g., matching games or quizzes).



Observation Checklist

- Listen to and observe students' responses to determine whether students can do the following:
 - Sketch the graph from a table of values created for a relation, and describe the patterns found in the graph to draw conclusions (e.g., graph the relationship between n and $2n + 3$).
 - Describe the relationship shown on a graph using everyday language in spoken or written form to solve problems.
 - Communicate mathematically.



Assessing Prior Knowledge

Materials:

- BLM 7.PR.9: Associating Clue Words with Operations and Expressions
- demonstration board

Organization: Pairs or small groups, whole class

Procedure:

The intent of this learning activity is to have students make generalizations that will help them interpret mathematical scenarios. Students should not be required to memorize the associations made, but rather should gain confidence in recognizing associations.

1. Divide students into pairs or groups. Inform students they will be working in pairs or in small groups to complete a chart (e.g., BLM 7.PR.9: Associating Clue Words with Operations and Expressions). The chart will show whether students know some clue words that may indicate which operation to use and whether they know how to represent a given problem as an expression or as an equation (e.g., older than, Geri is 4 years older than Kasha, $k + 4$ or $k + 4 = g$).
2. Distribute copies of BLM 7.PR.9: Associating Clue Words with Operations and Expressions, and have students work together in pairs or in small groups to complete the charts.
3. When students have had sufficient time to complete the charts, reassemble as a class. Verify students' understanding by having some students share a phrase, while others identify the clue word, the operation, and the expression or the equation. Take time to verify responses by substituting values and checking for reasonableness.

Variation:

- After the charts are complete, divide the class into two teams, and have a contest to see which team matches more phrases.

Observation Checklist

- Listen to and observe students' responses to determine whether students can do the following:
 - Associate clue words with correct operations.
 - Represent phrases with expressions or equations correctly.
 - Substitute values in the phrases and test for reasonableness.

Suggestions for Instruction

- **Solve a problem using a linear equation.**
- **Solve a problem using a linear equation and record the process.**

Materials:

- BLM 7.PR.10: Solving Single-Variable One-Step Equations

Organization: Individual, whole class

Procedure:

This learning activity invites students to use and develop their current strategies for solving equations. Later learning experiences will be devoted to solving equations through the preservation of equality.

1. Activate students' background knowledge by presenting a single-variable one-step linear equation, such as $d + 9 = 15$, and asking students to solve it. Point out that here a variable is being used to represent an unknown quantity. Ask students to describe how they arrived at the answer. Reinforce that there are multiple ways to solve problems. Consult the Background Information for more information. Provide or solicit a question for each operation.
2. Distribute copies of BLM 7.PR.10: Solving Single-Variable One-Step Equations, and have students solve the equations individually.
3. When students have had sufficient time to solve the equations, reassemble as a class, and have students share their solutions and strategies. This is a good opportunity to assess students' repertoire of strategies, and to have students hear alternative strategies from their classmates. Ask students how they would solve the equations if the values were larger, and less mental mathematics friendly. (This learning activity provides background for BLM 7.PR.11: Writing Expressions and Solving Equations That Match Word Descriptions, which will be used in the next learning activity.)

Variations:

- Students could write contextual problems to match each expression. Or, they could use the equations as models to write additional equations. The problems/equations could be added to a classroom problem/question bank for games, Entry Slips or Exit Slips, and so on.



Observation Checklist

- Listen to and observe students' responses to determine whether students can do the following:
 - Solve problems using single-variable one-step equations.
 - Explain a strategy used to solve the problems.
 - Apply mental mathematics strategies to solve problems.

Suggestions for Instruction

- **Solve a problem using a linear equation and record the process.**
- **Verify the solution to a linear equation using concrete materials or diagrams.**
- **Substitute a possible solution for the variable in a linear equation to verify the equality.**

Materials:

- BLM 7.PR.11: Writing Expressions and Solving Equations That Match Word Descriptions

Organization: Individual, whole class

Procedure:

This learning activity invites students to use and develop their current strategies for solving equations. Later learning experiences will be devoted to solving equations through the preservation of equality.

1. Distribute copies of BLM 7.PR.11: Writing Expressions and Solving Equations That Match Word Descriptions, and have students complete the tasks individually.
2. When students have had sufficient time to complete their work, have them reassemble as a class. Discuss students' responses. Test the reasonableness of the expressions, and substitute the solutions in the equations to verify their correctness.
Note: Question 2(c) in the BLM requires applying the order of operations.

Variations:

- Students write word problems that could be represented by the descriptions in the problems.
- Students add cards with descriptions representing expressions or equations, or word problems that can be represented with linear equations, to the classroom problem/question bank for games, Entry Slips or Exit Slips, and so on.



Observation Checklist

- Listen to and observe students' responses to determine whether students can do the following:
 - Represent word descriptions with correct expressions.
 - Write an equation to match a word description and solve the equation correctly.

Suggestions for Instruction

- **Represent a problem with a linear equation and solve the equation using concrete models.**
- **Model a problem with a linear equation and solve the equation using concrete models.**

Materials:

- demonstration board
- balance scales for each group of students (or student-made balances)
- blocks or cubes (interlocking optional)
- small paper bags, weigh boats, or polystyrene cups
- math journals or notebooks
- BLM 7.PR.12A: Representing Equivalent Expressions on a Balance Scale (Sample) (multiple copies optional)
- BLM 7.PR.12B: Representing Equivalent Expressions on a Balance Scale (Template)
- BLM 7.PR.12C: Representing Equivalent Expressions on a Balance Scale Using Variables for Unknowns (Sample)
- BLM 7.PR.12D: Representing Equivalent Expressions on a Balance Scale Using Variables for Unknowns (Template)
- BLM 7.PR.12E: Representing Equivalent Expressions (Template)

Organization: Whole class, small groups (of four)

Procedure:

1. Activate students' background knowledge by demonstrating an example to the class before students work in their small groups. This process is illustrated on BLM 7.PR.12A: Representing Equivalent Expressions on a Balance Scale (Sample). Record the demonstrated process on the demonstration board.
 - a) Present the balance scale to students, and ask them to describe the technology and its purpose. Sketch a schematic balance scale on the demonstration board.
 - b) Introduce the individual blocks as representing a value of 1. Blocks can be linked together to represent other quantities. Add a given number of blocks to one side of the scale. Count the blocks out loud, and arrange them neatly on the platform (e.g., 8). The pan will tip. Record the scale and the quantity pictorially and symbolically (8).
 - c) Invite a student to rebalance the scale. Stipulate that the student must use blocks, and cannot duplicate what is already on the opposite pan (e.g., use 7 joined blocks and 1 single block). Record this addition and the change pictorially and symbolically.

- d) Note that the two expressions are equivalent. The scale is balanced. Record the equation ($8 = 7 + 1$). Point out how the different parts of the equation symbolize the different parts of the scale.
 - e) Invite someone else to balance the scale in a different way, and record that equality. Include a third alternative.
 - f) All the expressions are equivalent to 8. Therefore, they must be equivalent to each other. Test the equivalency of the expressions by rearranging the 8 blocks on the balance scale into the different expressions. Record the equivalent expressions as sets or as a string (e.g., $8 = 7 + 1 = 4 + 4 = 3 + 5$). Note that all expressions between the equal signs are different names for the same quantity. This is also an opportunity to revisit the commutative property of addition.
2. Have students, working in groups, repeat the demonstrated process using their own values. Each student will record actions pictorially and symbolically. A suggested procedure and template are found on BLM 7.PR.12B: Representing Equivalent Expressions on a Balance Scale (Template). Templates are supplied for use with and without variables. Students may also use their math journals or notebooks.
 - a) One student in each group has the responsibility of setting a quantity on either side of the scale, and then announces the quantity, draws a scale, and records the quantity.
 - b) Other students in the group take turns representing equal quantities on the opposite side of the scale, or rearranging the quantities in a pan. They verbalize their actions as they perform them, and record the process pictorially and symbolically.
 3. As soon as students are ready, reassemble as a class, and demonstrate balancing the scale using blocks or cubes in paper bags or cups. The concealed quantities represent the unknown meaning of a variable. It may be necessary to tare the scales to compensate for the mass of the empty bag or cup.
 - a) Secretly add a number of blocks to the bag (e.g., 3). Add the bag and a number of cubes to one pan of the scale. Record the action pictorially and symbolically ($(b + 4)$, where b represents the quantity in the bag).
 - b) Invite a student to balance the scale with a number of blocks, counting them in the process. Record the pictorial representation and the linear relation ($b + 4 = 7$).
 - c) Invite a student to rename 7 in terms of b . (Use two bags with 3 blocks in each bag and 1 single block.)
 - d) Another student can rearrange the blocks again, or identify the number of blocks in the bag.
 - e) Demonstrate an unbalanced solution with an empty bag and some blocks on one pan and some blocks on the other pan. Ask students how to find the value of b and rebalance the scale. (Count blocks into the bag until the scale balances.)

4. Have students work in groups to repeat the process with variables. Once again, have students share roles to model, represent, and record equality in their math journals or on the BLM template(s).

This learning activity prepares students for demonstrating preservation of equality and using preservation of equality to solve equations.

Variation:

- Arrange blocks without a scale. Count to verify equivalency.



Observation Checklist

- Listen to and observe students' responses to determine whether students can do the following:
 - Use a balance scale to model equivalent expressions.
 - Write equivalent expressions without variables as equations.
 - Write equivalent expressions with variables as equations.
 - Model and record the commutative property of addition.
 - Reason mathematically.

Suggestions for Instruction

- **Substitute a value for each unknown in an expression and evaluate the expression.**

Materials:

- BLM 7.PR.13: Evaluating Expressions, Given a Value for the Variable
- marking pens

Organization: Whole class, individual

Procedure:

1. As a class, activate students' background knowledge by asking individual students to
 - a) define a *variable* and provide an example of one
 - b) define an *expression* and provide an example of an expression using the variable provided
 - c) suggest a value for the variable
 - d) substitute that value for the variable and evaluate the expression
 - e) offer a different expression using the same variable
 - f) evaluate the expression using the same value for the variable
 - g) provide a different value and evaluate the expression using the new value

2. When you are satisfied that students are able to complete this task individually, distribute copies of BLM 7.PR.13: Evaluating Expressions, Given a Value for the Variable.
3. When students have had sufficient time to evaluate the expressions, ask them to reassemble as a class, share their answers, discuss any discrepancies, and use a marking pen to make any notes, corrections, or additions to their sheets. The sheets can be used for study notes at a later date.

Variation:

- Have students create some additional expressions of their own, using a new variable and/or values to substitute for the new variable in their expressions. Students could exchange their expressions and have a classmate assess them.



Observation Checklist

- Listen to and observe students' responses to determine whether students can do the following:
 - Substitute a value for each unknown in an expression and evaluate the expression.
 - Apply mental mathematics strategies to solve problems.

Suggestions for Instruction

- **Model the preservation of equality for addition, subtraction, multiplication, or division using concrete materials or using pictorial representations, explain the process orally, and record it symbolically.**
- **Provide an example of an expression and an equation, and explain how they are similar and different.**

Materials:

- demonstration board
- balance scales for each group of students (or student-made balances)
- blocks or cubes (interlocking optional)
- small paper bags or polystyrene cups
- poster paper
- math journals or notebooks
- algebra tiles (optional)
- pens or markers of different colours (optional)

Organization: Whole class (with three recorders and one “voice”), small groups, individual

Procedure:

1. Activate students’ background knowledge by having a group of students use a balance scale to model and record changes to an equation. One student may provide the concrete model, while two others record the pictorial and symbolic representations of the equation on the demonstration board. One student can act as “the voice,” modelling self-talk during the investigation.
 - a) Model an equation with no variables.
 - b) Have students predict the outcome of adding 1 to the pan on one side of the balance.
 - c) Perform the action. (The equation is unbalanced.) Record the action symbolically with less than ($<$) or greater than ($>$) symbols.
 - d) Ask what will happen if 1 is added to the expression on the other pan. (Balance is restored.)
 - e) Play a game, asking students to predict balance or tilt, and the direction of tilt, if different quantities are added to either or both of the pans. Have students model an equation, record the action, and comment on what is happening for each scenario as it is performed. Include equations with variables in the form of bags or cups.
 - f) Ask students to formulate a conclusion about preserving equality in an equation when using addition. (Adding the same amount to each side of the equation preserves equality.)
2. Have students work in small groups to conduct the same investigation and draw a conclusion for each of the other operations: subtraction, multiplication, and division. Be sure to have them model concretely, represent pictorially, record symbolically, talk through and explain the process, and formulate conclusions.
3. Students can record conclusions in their math journals, or prepare personal posters about preserving equality in an equation. Ask them to include pictorial and symbolic representations, as well as an explanation of why the same operation must be applied to each expression to maintain equality. In this investigation, students have repeatedly used the terms *expression* and *equation*. Have them include a statement in their math journals that explains how expressions and equations are similar and how they are different.

This learning activity prepares students for solving a problem using preservation of equality in the next learning experience.

Variations:

- Use algebra tile models in place of, or in addition to, balance scale models.
- Investigate graphs as concrete representations of equivalent expressions. Graph the equivalent expressions in different colours on the same axes.



Observation Checklist

- Listen to and observe students' responses to determine whether students can do the following:
 - Model the preservation of equality for addition, subtraction, multiplication, or division using concrete materials or using pictorial representations, explain the process orally, and record it symbolically.
 - Provide an example of an expression and an equation, and explain how they are similar and different.

Suggestions for Instruction

- **Solve a problem by applying preservation of equality.**
- **Draw a visual representation of the steps required to solve a linear equation.**
- **Verify the solution to a linear equation using concrete materials or diagrams.**
- **Substitute a possible solution for the variable in a linear equation to verify the equality.**

Materials:

- BLM 7.PR.14A: Solving Linear Equations: Pictorial and Symbolic Representations
- BLM 7.PR.14B: Solving Linear Equations with Constants: Applying the Preservation of Equality
- BLM 7.PR.14C: Solving Equations with Numerical Coefficients: Applying the Preservation of Equality
- BLM 7.PR.14D: Solving Linear Equations with Constants and Numerical Coefficients: Applying the Preservation of Equality
- demonstration board
- balance scales for each group of students (or student-made balances)
- blocks or cubes (interlocking optional)
- small paper bags or polystyrene cups
- math journals or notebooks
- counters and algebra tiles (optional)

Organization: Whole class, pairs or small groups

Procedure:

The previous learning experience, in which students modelled and explained the preservation of equality for each of the four operations, provides a foundation for this learning experience. The emphasis here is on having students develop a strategy to solve a linear equation.

*Part A***1. Represent a linear equation with a constant.**

- Begin with a simple concrete representation of a one-step equation with a single variable.
- Revisit the example of 3 blocks or cubes in a bag, combined with 4 single blocks, on one pan of the scale, balanced by 7 cubes on the other pan. Record the pictorial representation of the balance and the linear relation $b + 4 = 7$, where b represents the quantity in the bag.

2. Represent the solution using the preservation of equality.

- Students know there are 3 blocks in the bag. Knowing basic number facts makes this an easy equation to solve. Propose that sometimes equations are not easy to solve, and it would be helpful to have a strategy to find the solution. Easy questions assist with developing strategies, because ideas and errors are more obvious in easy questions. Ask students to suggest some strategies.
- Empty the bag. Students will observe that the balance tilts. Ask students how to find the value of b and rebalance the scale. Add blocks to the bag until the scale balances, counting the blocks in the process. Counting the blocks that balance the scale provides a concrete model to verify a solution.
- Challenge students to prove there are 3 blocks in the bag by applying the principles they learned about the preservation of equality. Applying identical operations to both expressions will preserve the equality of the relation. Remove 4 from each side of the balance. Ending up with the bag on one pan and 3 blocks on the other pan indicates there are 3 blocks in the bag. When the equation is solved, verify the solution symbolically by substituting 3 in the original equation. Alternatively, verify the solution concretely by opening the bag and counting the blocks. As students make suggestions, record their suggestions pictorially and symbolically.
- The strategy is outlined with both a balance scale and algebra tiles in the Background Information.

3. Develop and test a strategy.

- When students are sufficiently prepared, suggest that they work with partners or in small groups to test more equations containing a variable and a constant. For each equation they test, have students talk through steps as they proceed, and verify the solution.

- Apply the strategy to equations in which the arithmetic is not so easy (e.g., $b + 17 = 42$). Include negative constants (e.g., $b - 9 = 7$). It may be necessary to review the principles of adding and subtracting integers.
4. **Record the process.**
- When students have a process that works, ask them to record it on BLM 7.PR.14A: Solving Linear Equations: Pictorial and Symbolic Representations or in their math journals. Students include the linear equation and the pictorial and symbolic representations of the steps used to solve the equation. They also verify the solution, and articulate a streamlined process for solving a linear relation with a constant.
 - The process of solving a linear equation may include the following:
 - Aim to isolate the variable on one side of the equation and a quantity on the other side.
 - Remove the constant from the variable by adding its opposite to each side of the equation (similar to zero pairs—refer to Background Information for learning outcome 7.N.6).
 - Equate the variable with a quantity in the final equation.
 - Verify the solution by substituting the quantity for the variable in the equation.
5. **Apply the strategy.**
- Ask students to test their process by applying it to linear equations with constants, such as those included on BLM 7.PR.14B: Solving Linear Equations with Constants: Applying the Preservation of Equality.

Part B

1. Review the process for solving a linear equation that students created in Part A. Have four volunteers work together to model and solve a linear equation with one variable and a constant. One volunteer talks through the steps, one models the concrete representation, one models the pictorial representation, and one models the symbolic representation.
2. Have students work with their partners or small groups to continue the investigation of Part A. In Part B, challenge students to outline a process to solve linear equations with a numerical coefficient (e.g., $4c = 36$), and then progress to a process to solve linear equations with a combination of coefficients and constants (e.g., $2b + 6 = 14$).
3. For each equation students work through, have them articulate the action they take, and verify their solution concretely or with substitution. Ask them to record both pictorial and symbolic steps to solve the equations, using either their math journals or BLM 7.PR.14A: Solving Linear Equations: Pictorial and Symbolic Representations.
4. Have students apply the process for solving linear equations by completing BLM 7.PR.14C: Solving Equations with Numerical Coefficients: Applying the Preservation of Equality and BLM 7.PR.14D: Solving Linear Equations with Constants and Numerical Coefficients: Applying the Preservation of Equality.

5. When students have completed their exploration, have individual students create a personal or class poster outlining the steps to solve linear equations using the preservation of equality. Remember to include a verification step.

Variations:

- Use a variety of concrete materials. Model solutions for the same or different problems using counters and/or commercial or student-made algebra tiles. Students benefit from being familiar with multiple representations.
- Extend the learning activity by having students create contextual problems to match the linear equations they work with.



Observation Checklist

- Listen to and observe students' responses to determine whether students can do the following:
 - Solve a problem by applying the preservation of equality.
 - Draw a visual representation of the steps required to solve a linear equation.
 - Verify the solution to a linear equation using concrete materials or diagrams.
 - Substitute a possible solution for the variable in a linear equation to verify the equality.

Suggestions for Instruction

- **Represent a problem with a linear equation and solve the equation using concrete models.**
- **Model a problem with a linear equation and solve the equation using concrete models.**
- **Draw a visual representation of the steps required to solve a linear equation.**
- **Solve a problem using a linear equation.**
- **Solve a problem using a linear equation and record the process.**
- **Verify the solution to a linear equation using concrete materials or diagrams.**
- **Substitute a possible solution for the variable in a linear equation to verify the equality.**

Materials:

- demonstration board
- a collection of problems that can be represented by linear equations (use those completed in previous learning activities, those completed for the classroom question box, a collection of teacher-prepared problems, or BLM 7.PR.15: Problems to Represent with Linear Equations and with Concrete Materials)
- concrete materials to represent the preservation of equality (balance scales, tiles, counters)—one set of materials at each learning station
- recording booklets (two sheets of paper folded in half and stapled)—one booklet for each group

Organization: Learning stations with one or two problems at each station (one more station than the number of groups in the class), groups of four students

Procedure:

1. Set up learning stations in the classroom with one set of concrete materials and one or two problems at each station. Decide how many stations students must visit and how many problems students must complete.
2. Record the following four student roles on the demonstration board:
 - a) Read the problem aloud. Record the linear equation that matches the problem.
 - b) Explain the steps to follow in solving the problem. Model the solution to the problem using the concrete materials at the station.
 - c) Record a diagram of the steps followed to solve the problem. Write the symbolic representation of the solution.
 - d) Verify the solution, first by setting up the concrete materials in a balanced fashion, and then by substitution.

3. Students work together to find solutions to the problems, and take turns performing each of the four roles. They use the group's booklet to record equations, steps, solutions, and verification. Have students initial their entries in the booklet.

Variations:

- Offer students choice regarding the problems to be solved, or control the questions or type of questions students must answer.
- The problems above contain small quantities to facilitate modelling with concrete materials. For a given number of problems, have students write similar problems using larger numbers, and solve them using diagrams and/or symbolic representations.



Observation Checklist

- Listen to and observe students' responses to determine whether students can do the following:
 - Represent a problem with a linear equation and solve the equation using concrete models.
 - Model a problem with a linear equation and solve the equation using concrete models.
 - Draw a visual representation of the steps required to solve a linear equation.
 - Solve a problem using a linear equation.
 - Solve a problem using a linear equation and record the process.
 - Verify the solution to a linear equation using concrete materials or diagrams.
 - Substitute a possible solution for the variable in a linear equation to verify the equality.

Suggestions for Instruction

- **Represent a problem with a linear equation and solve the equation using concrete models.**
- **Model a problem with a linear equation and solve the equation using concrete models.**
- **Draw a visual representation of the steps required to solve a linear equation.**
- **Solve a problem using a linear equation.**
- **Solve a problem using a linear equation and record the process.**
- **Verify the solution to a linear equation using concrete materials or diagrams.**
- **Substitute a possible solution for the variable in a linear equation to verify the equality.**

Materials:

- access to research materials
- assorted materials to create questions and answers, game boards, and support materials
- booklets (for recording solutions)
- concrete materials for representing the preservation of equality (balance scales, blocks and bags, counters, algebra tiles)

Organization: Small groups, individual

Procedure:

Inform the class that groups of students will develop events or games, such as the following.

- **Around the World in 10 Equations**

Students collect passport stamps as they move from one city to another on a regional or world map. To obtain transportation from one destination to the next, travellers must use a linear equation to solve a problem about information related to the region. Each traveller records equations and solutions in his or her passport book. Correct solutions earn travellers a passport stamp and a ticket to the next destination. Students receive a souvenir upon completing the journey.

- **Relations Regatta**

Students enter a boat race. They collect strips to represent the distance completed as they progress through the course. To cover distance in the course, competitors must use linear equations to solve problems related to marine life, nautical vessels, and so on. Each competitor records the equation and solution in his or her logbook. Correct solutions earn participants a distance strip and an event pass to the next section of the course. Students receive a trophy for completing the race.

Part A

Students develop an event or a game.

1. Form groups and choose which event to host.
2. Select the topics on which to base questions.
3. Assign topics to individuals.
4. Individuals research their respective topics to collect information from which to create problems.
5. Each student creates two or three problems that can be represented by a linear equation, and tests the solution to the problems based on the preservation of equality.
6. Include one question with a constant, one with a numerical coefficient, and one with both a numerical coefficient and a constant.
7. Groups decide on the format for presenting the problems and concealing the solutions.
8. Individuals prepare good copies of the problems and concealed solutions. Solutions must include pictorial and symbolic representations of the solutions, and verification of the solutions.
9. Decide on the details required for the physical presentation to play the game and receive tokens.
10. Assign responsibilities, and create the product.
11. Test the game, and address any problem areas.

Part B

Students play the games created by others and collect the rewards.

1. Students decide which event they will participate in, and form groups to play each game.
2. Students progress through the game independently. Each individual reads the problems, and uses his or her booklet to represent each problem as a linear equation, and to record the steps used to solve the problem using the preservation of equality.
3. Students collect the rewards at the end of the game.



Observation Checklist

- Listen to and observe students' responses to determine whether students can do the following:
 - Draw a visual representation of the steps required to solve a linear equation.
 - Solve a problem using a linear equation.
 - Solve a problem using a linear equation and record the process.
 - Verify the solution to a linear equation using concrete materials or diagrams.
 - Substitute a possible solution for the variable in a linear equation to verify the equality.



Relations Stories

Introduction:

Students create a book, graphic novel, or cartoon strip emphasizing patterns, their relations, and related vocabulary terms.

Purpose:

In this investigation, students have the opportunity to demonstrate any or all of the following abilities (connections to learning outcomes are identified in parentheses):

- Correlate oral and written patterns and linear relations. (7.PR.1)
- Construct and analyze a table of values and graphs to solve problems based on linear relations. (7.PR.2)
- Apply the preservation of equality to solve equations. (7.PR.3)
- Differentiate between expressions and equations. (7.PR.4)
- Evaluate expressions, given the value of the variable(s). (7.PR.5)
- Solve one-step linear equations. (7.PR.6)
- Solve problems represented by linear equations. (7.PR.7)
- Relate radii, diameters, and circumferences of circles and solve problems involving the measurement of circles. (7.SS.1)
- Apply formulas to determine the area of triangles, parallelograms, and circles. (7.SS.2)

Students will also demonstrate some or all of the following mathematical processes:

- Communication
- Connections
- Mental Mathematics and Estimation
- Problem Solving
- Reasoning
- Technology
- Visualization

Materials/Resources:

- BLM 5–8.25: My Success with Mathematical Processes
- books based on problems related to patterns, relations, and linear equations, such as the following:

Gravett, Emily. *The Rabbit Problem*. London, UK: Macmillan Children’s Books, 2009.

McCallum, Ann. *Rabbits Rabbits Everywhere: A Fibonacci Tale*. Illus. Gideon Kendall. Watertown, MA: Charlesbridge Publishing Inc., 2007.

Neuschwander, Cindy. *Sir Cumference and the Isle of Immeter: A Math Adventure*. Illus. Wayne Geehan. Watertown, MA: Charlesbridge Publishing Inc., 2006.
- book-making supplies
- computer access (optional)

Organization: Individual, pairs

Procedure:*Student Directions*

1. The world around us abounds with patterns and relations. Patterns can be described, can provide an interesting source of information and investigation, and can be used to create and solve mysteries.

Example:

Mathematician Leonardo Fibonacci lived in Italy around the year 1200. He introduced Hindu-Arabic numbers to Europe, and revealed an interesting number pattern in an investigation of the rate at which a single pair of rabbits multiplies. Interesting number patterns are prevalent in nature.

Sample Website:

Examples of patterns and relations (e.g., Fibonacci numbers, Pascal’s triangle, fractals) can be viewed on websites such as the following:

World-Mysteries.com. “Fibonacci Numbers in Nature and the Golden Ratio.” *Science Mysteries*. 2002–2011. http://old.world-mysteries.com/sci_17.htm.

2. Listen to your teacher read *The Rabbit Problem* by Emily Gravett. Note references to Fibonacci and to patterns and relations.
3. Note the book’s organization around Fibonacci’s question, and how its presentation as a calendar matches the investigation period of one year. Note the author’s subtle references.
4. Listen to your teacher read *Sir Cumference and the Isle of Immeter* by Cindy Neuschwander. This book solves area problems using relationships between area and the sides of rectangles and relationships between radius and circumference.

5. Create your own Adventures in Algebra series of stories involving patterns, relations, variables, and equations.
 - Stories may be patterned after *The Rabbit Problem* and presented as a calendar using a scene for each month of the year, or stories may be presented as books, graphic novels, or cartoon strips.
 - Stories may include main characters or a hero such as the Master of Relations and his sidekick the Vari Able Generator.
 - Stories should present patterns, equations, or mysteries to solve, which may be design-oriented, or focus on music, or involve quantity or measurements such as time, distance, or area. The story components and assessment criteria are outlined in My Planning Sheet for Relations Stories (see next page).
6. Once you have decided on a plan, share your ideas using My Planning Sheet for Relations Stories.
7. Begin work on your project.
8. Share your stories with peers, with younger students, as part of an authors' night, or in a library display.
9. Record your success using BLM 5–8.25: My Success with Mathematical Processes.

Assessment:

1. Students will demonstrate their learning in the different categories identified in Assessment of Relations Stories (see last two pages of Patterns and Relations), based on how they choose to complete the project. Have a conversation with each student about which learning he or she will demonstrate to you through the process of designing the product.
2. Work with students to develop assessment criteria in each of the identified categories.
3. The final assessment of each category should be based on a student's recent consistent demonstration of learning.
4. Distribute copies of BLM 5–8.25: My Success with Mathematical Processes, and have each student record his or her success with the mathematical processes.

My Planning Sheet for Relations Stories

Name _____ Date _____

What will I show? (Check at least four boxes in Section 1 and two boxes in Section 2)	How do I know that I have been successful?	How will I show it?
Section 1: Knowledge and Understanding of Mathematical Concepts		
<input type="checkbox"/> I can give examples of patterns and I can explain those patterns using math equations (like $d = 2c + 1$). (7.PR.1)	<input type="checkbox"/> I gave one or more examples of patterns and I used math equations to show another way to explain the patterns.	
<input type="checkbox"/> I can look at a pattern and show the steps of a pattern using a T-chart and a graph. (7.PR.2)	<input type="checkbox"/> I used a T-chart and a graph to show how a pattern changes.	
<input type="checkbox"/> I know that both sides of an equation are equal, and this helps me to solve equations. (7.PR.3)	<input type="checkbox"/> I solved one or more equations and showed that I remembered to keep both sides of the equation equal when solving it.	
<input type="checkbox"/> I know the difference between an equation and an expression. (7.PR.4)	<input type="checkbox"/> I showed an expression and an equation and I showed how they are different.	
<input type="checkbox"/> I can replace a variable with a number to solve an expression. (7.PR.5)	<input type="checkbox"/> I replaced a variable with a number to solve an expression.	
<input type="checkbox"/> I know how to solve equations that can be solved in only one step (like $2y = 8$ or $p + 2 = -1$). (7.PR.6)	<input type="checkbox"/> I solved equations that needed only one step to find the answer.	
<input type="checkbox"/> I can solve circle problems (like radius, circumference, and diameter). (7.SS.1)	<input type="checkbox"/> I showed that I understand the different measurements in circles.	

(continued)

My Planning Sheet for Relations Stories (continued)

Name _____ Date _____

What will I show? (Check at least four boxes in Section 1 and two boxes in Section 2)	How do I know that I have been successful?	How will I show it?
<p align="center">Section 1: Knowledge and Understanding of Mathematical Concepts (continued)</p>		
<input type="checkbox"/> I can figure out the area of triangles, parallelograms, and circles using formulas. (7.SS.2)	<ul style="list-style-type: none"> ■ I figured out the area of triangles, parallelograms, and circles using a formula I know or a formula that I figured out. 	
<input type="checkbox"/> I can use math language when describing patterns.	<ul style="list-style-type: none"> ■ I used math language that I already knew and math language that I was learning while showing what I knew about patterns. 	
<p align="center">Section 2: Mental Mathematics and Estimation</p>		
<input type="checkbox"/> I can use mental math and estimation to help me solve expressions (like $b + 5$). (7.PR.5)	<ul style="list-style-type: none"> ■ I used mental math to solve expressions and to check that my answers were correct. ■ I estimated to make sure my answers made sense. 	
<input type="checkbox"/> I can use mental math and estimation to help me solve and check equations that can be solved in only one step (like $2y = 8$ or $p + 2 = -1$). (7.PR.6)	<ul style="list-style-type: none"> ■ I used mental math to solve equations and to check that my answers were correct. ■ I estimated to make sure my answers made sense. 	
<input type="checkbox"/> I can use estimation when solving circle problems (radius, circumference, or diameter). (7.SS.1)	<ul style="list-style-type: none"> ■ I estimated to make sure my answers made sense. 	
<input type="checkbox"/> I can figure out the area of triangles, parallelograms, and circles using formulas. (7.SS.2)	<ul style="list-style-type: none"> ■ I used mental math to figure out the area of triangles, parallelograms, and circles. ■ I estimated to make sure my answers made sense. 	

Assessment of Relations Stories

Criteria	4	3	3	1	Not Demonstrated (ND)
Knowledge and Understanding of Mathematical Concepts					
<input type="checkbox"/> Provide examples or scenarios of patterns and linear relations. (7.PR.1)	<ul style="list-style-type: none"> ■ makes connections among pattern examples/scenarios and their linear relations 	<ul style="list-style-type: none"> ■ demonstrates a good understanding of how to connect pattern examples/scenarios and their linear relations 	<ul style="list-style-type: none"> ■ connects basic pattern examples/scenarios and their linear relations 	<ul style="list-style-type: none"> ■ requires support to connect basic pattern examples/scenarios and their linear relations 	<ul style="list-style-type: none"> ■ does not connect pattern examples/scenarios and their linear relations
<input type="checkbox"/> Create tables of values and graphs based on linear relations. (7.PR.2)	<ul style="list-style-type: none"> ■ accurately represents linear relations as graphs and tables of values 				
<input type="checkbox"/> Use preservation of equality to solve equations. (7.PR.3)	<ul style="list-style-type: none"> ■ demonstrates an understanding of preservation of equality when solving equations 				
<input type="checkbox"/> Differentiate expressions from equations. (7.PR.4)	<ul style="list-style-type: none"> ■ differentiates between expressions and equations 				
<input type="checkbox"/> Evaluate expressions, given the value of the variable(s). (7.PR.5)	<ul style="list-style-type: none"> ■ substitutes a value for the variable in order to solve an expression 				
<input type="checkbox"/> Solve one-step linear equations. (7.PR.6)	<ul style="list-style-type: none"> ■ solves one-step linear equations concretely, pictorially, or symbolically 				
<input type="checkbox"/> Solve problems involving measurements of circles. (7.SS.1)	<ul style="list-style-type: none"> ■ demonstrates an understanding of measurement related to circles (radius, circumference, and diameter) 				

(continued)

Assessment of Relations Stories (continued)

Criteria	4	3	3	1	Not Demonstrated (ND)
Knowledge and Understanding of Mathematical Concepts (continued)					
<input type="checkbox"/> Determine the area of triangles, parallelograms, and circles by applying formulas. (7.SS.2)	<ul style="list-style-type: none"> develops/applies a formula for determining the area of triangles, parallelograms, and/or circles 				
<input type="checkbox"/> Use related vocabulary.	<ul style="list-style-type: none"> demonstrates an understanding and application of mathematics vocabulary 				
Mental Mathematics and Estimation					
<input type="checkbox"/> Evaluate expressions, given the value of the variable(s). (7.PR.5)	<ul style="list-style-type: none"> applies mental mathematics strategies to solve expressions 				
<input type="checkbox"/> Solve one-step linear equations. (7.PR.6)	<ul style="list-style-type: none"> applies mental mathematics strategies to solve one-step linear equations and to check the accuracy of the solutions 				
<input type="checkbox"/> Solve problems involving measurements of circles. (7.SS.1)	<ul style="list-style-type: none"> makes reasonable estimates when solving problems involving the measurements of circles 				
<input type="checkbox"/> Determine the area of triangles, parallelograms, and circles by applying formulas. (7.SS.2)	<ul style="list-style-type: none"> applies mental mathematics strategies to determine the area of triangles, parallelograms, and circles, and makes reasonable estimates to determine the accuracy of the solutions 				



GRADE 7 MATHEMATICS

Shape and Space

Shape and Space (Measurement) (7.SS.1)

Enduring Understanding(s):

Circle graphs show a comparison of each part to a whole using ratios.

Many geometric properties and attributes of shapes are related to measurement.

General Learning Outcome(s):

Use direct or indirect measurement to solve problems.

SPECIFIC LEARNING OUTCOME(S):	ACHIEVEMENT INDICATORS:
<p>7.SS.1 Demonstrate an understanding of circles by</p> <ul style="list-style-type: none">■ describing the relationships among radius, diameter, and circumference of circles■ relating circumference to pi (π)■ determining the sum of the central angles■ constructing circles with a given radius or diameter■ solving problems involving the radii, diameters, and circumferences of circles <p>[C, CN, R, V]</p>	<ul style="list-style-type: none">→ Illustrate and explain that the diameter is twice the radius in a circle.→ Illustrate and explain that the circumference is approximately three times the diameter in a circle.→ Explain that, for all circles, pi (π) is the ratio of the circumference to the diameter $\left(\frac{C}{d}\right)$, and its value is approximately 3.14.→ Explain, using an illustration, that the sum of the central angles of a circle is 360°.→ Draw a circle with a given radius or diameter with or without a compass.→ Solve a contextual problem involving circles.

PRIOR KNOWLEDGE

Students may have had experience with the following:

- Demonstrating an understanding of perimeter of regular and irregular shapes by
 - estimating perimeter using referents for centimetre or metre
 - measuring and recording perimeter (cm, m)
 - constructing different shapes for a given perimeter (cm, m) to demonstrate that many shapes are possible for a perimeter
- Demonstrating an understanding of ratio, concretely, pictorially, and symbolically.

- Demonstrating an understanding of angles by
 - identifying examples of angles in the environment
 - classifying angles according to their measure
 - estimating the measure of angles using 45° , 90° , and 180° as reference angles
 - determining angle measures in degrees
 - drawing and labelling angles when the measure is specified
- Developing and applying a formula for determining the
 - perimeter of polygons
 - area of rectangles
 - volume of right rectangular prisms

For more information on prior knowledge, refer to the following resource:

Manitoba Education and Advanced Learning. *Glance Across the Grades: Kindergarten to Grade 9 Mathematics*. Winnipeg, MB: Manitoba Education and Advanced Learning, 2015. Available online at www.edu.gov.mb.ca/k12/cur/math/glance_k-9/index.html.

RELATED KNOWLEDGE

Students should be introduced to the following:

- Constructing a table of values from a relation, graphing the table of values, and analyzing the graph to draw conclusions and solve problems.
- Evaluating an expression given the value of the variable(s).
- Modelling and solving problems that can be represented by one-step linear equations of the form $x + a = b$, concretely, pictorially, and symbolically, where a and b are integers.
- Modelling and solving problems that can be represented by linear equations of the form
 - $ax + b = c$
 - $ax = b$
 - $\frac{x}{a} = b, a \neq 0$
 concretely, pictorially, and symbolically, where a , b , and c , are whole numbers.
- Developing and applying a formula for determining the area of
 - triangles
 - parallelograms
 - circles
- Constructing, labelling, and interpreting circle graphs to solve problems.

BACKGROUND INFORMATION

Angles and Circles

Students come to Grade 7 with a background in classifying and measuring angles. *Angles* are formed from two rays emanating from a common point, and *circles* are all the points equidistant from a common point. Angles are measured as fractions of circles, each degree being $\frac{1}{360}$ of a circle. The number 360 is said to be related to Sumerian and Babylonian observations of tracking the movement of astronomical objects through the sky for the 360 days in their year. The number 360 is convenient because it has multiple factors.

In the learning experiences that follow, the close relation between angles and circles is used as a starting point to develop an understanding of circle concepts. A *circle* is the full rotation of an angle. The ability to look for and describe patterns with variables and equations is used to discover the relationships and ratios within circles, and these ratios are used to solve contextual problems. Learning experiences that involve describing the relationships in circles and solving problems involving circles correspond well with the Variables and Equations substrand of the Patterns and Relations strand.

The first concept developed in the following learning experiences is the sum of central angles. Angles are used to develop concepts related to radius, circle, and circumference. The concept of radius is used to construct circles of a given size, and students measure circumference in terms of radius in their first investigation about relationships in circles. The term *diameter* is built from connecting two radii, and further relationships are determined between diameter and circumference. Students develop accurate measuring skills, and discover the ratio between the circumference and the diameter of circles. The ratio is approximated as 3.14, and is commonly referred to as *pi* (π). The relation $\left(\frac{C}{d}\right)$ is a very important mathematical constant. There is evidence of its use in Ancient Egypt, Ancient Babylon, Ancient Israel, and Ancient India. The Ancient Greeks studied the relationship very carefully and represented it as $\frac{22}{7}$. For every circle, the circumference divided by the diameter is a non-terminating non-repeating decimal. In the 1700s, it was given a special name, *pi*. The name was chosen because pi is the first letter in the Greek phrase for perimeter/diameter. It is common to use the approximate value 3.14 for pi. Many people are fascinated with the number that represents pi. There is even a special Pi Day celebrated March 14 (3/14).

You may wish to have students research pi and share the information they find. It is important that students recognize that pi is not so much a special number as it is a special relationship (the relationship of the circumference of a circle divided by its diameter).

Teachers are encouraged to provide hands-on learning activities and group work as a means for students to develop skills and to explore and discover the concepts and relationships within circles. Guide students in their learning and provide vocabulary to describe the concepts, while allowing students to make discoveries. Based on the relationships they discover, students can develop contextual problems for one another to solve.

MATHEMATICAL LANGUAGE

angle
arc
central angle
circle
circumference
classifications of angles (acute, obtuse, reflex, right, straight, complementary, and supplementary)
diameter
pi
radius

LEARNING EXPERIENCES



Assessing Prior Knowledge

Materials:

- BLM 7.SS.1.1: Assorted Angle Cards (or diagrams of various angles of different sizes, including acute, obtuse, reflex, right, and straight angles)
- BLM 7.SS.1.2: Angle Classifications, Angle Estimations and Measures, and Perimeter
- display board
- tacks, tape, or magnets to hold angle cards on a display
- protractors

Organization: Whole class, individual

Procedure:

1. Advise students they will review what they already know about angles by sorting angle cards into the different classifications of angles. Give each student one of the cards from BLM 7.SS.1: Assorted Angle Cards. Invite students to post their angle cards (or sketch the represented angles) with the similar angles on the display board.

2. Students can critique the angle display and share any adjustments they would like to make to correct it. Review definitions of the different classifications of angles (*acute, obtuse, reflex, right, and straight angles*).
3. Return the cards to students. Invite students to use their estimation skills to identify an angle that matches an approximate measurement. They may show their response by displaying a card or by sketching an angle. Ask students how to verify the measurement. Review the use of protractors, and have students measure their angles using protractors.
4. Review the concept of perimeter by having students estimate the measure of the perimeter of designated surfaces (e.g., a tissue box, desk surface, classroom door, window, ceiling), and having them justify their responses. Tracing the edge of objects with a finger reinforces that the perimeter is the distance around the outside of the object.
5. Distribute copies of BLM 7.SS.1.2: Angle Classifications, Angle Estimations and Measures, and Perimeter, and have students respond to the questions provided.

Variations:

- Use the angle cards to play games in which students collect a set of one classification of angles or a set of each classification of angles (*acute, obtuse, reflex, right, straight*). Or use the cards to play other types of games (e.g., Concentration, Pit).
- Play an I Spy game to develop students' understanding of perimeter (e.g., "I spy a perimeter close to . . .").

Observation Checklist

- Listen to and observe students' responses to determine whether students can do the following:
 - Classify angles of different sizes as acute, obtuse, reflex, right, or straight angles.
 - Estimate the size of angles and confirm the estimate by measuring the angles with a protractor.
 - Demonstrate an understanding of perimeter.

Suggestions for Instruction

- **Explain, using an illustration, that the sum of the central angles of a circle is 360° .**

Materials:

- BLM 7.SS.1.3: Cut-outs for Angles of Different Measures (one of each of the six types per group, copied on card stock or on bond paper, plus extra copies if students will make posters)
- demonstration board
- large cut-outs of angles (two copies of 45° and 90° angles, one copy of 180° angle) (optional)
- card stock or bond paper
- scissors
- protractors
- math journals
- file cards
- resealable bags for storage (optional)
- poster paper (optional)
- glue (optional)
- computer software (optional)

Organization: Whole class, small groups

Procedure:

1. Guide students through a class discussion while building a circle using angles. A sample procedure follows:
 - Draw or use a large cut-out of a 45° angle, and have students estimate the measure of the angle. Ask what the diagram resembles if the ends of the rays are connected with an arc.

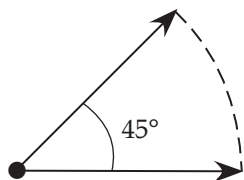

- Stack two angles, one next to the other, with the vertices meeting. Ask for an approximation of the angle represented (90°). Connect the rays with another arc, and ask what the image resembles now.

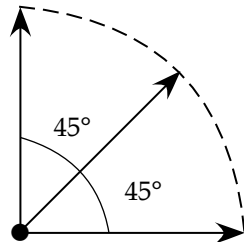

- Line up a reflection of another 90° angle alongside the image. Continue to ask for an estimation of the measure of the angle (180°), and what the angle resembles.

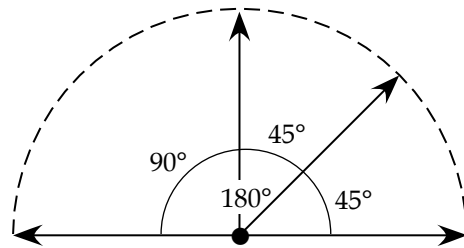

- Complete the task by adding a 180° angle below the image. Solicit an estimation of the measure and a description of the image (360° circle).

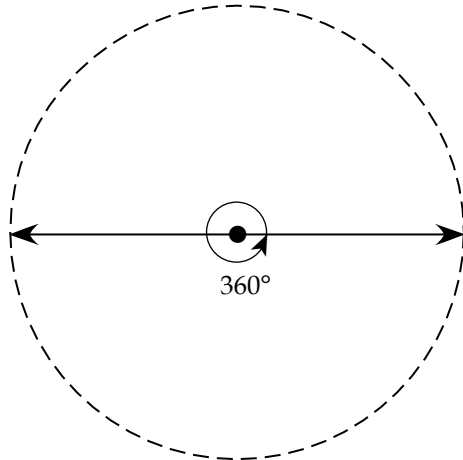

- Point out to students (either now or following some more investigation) that the vertices of all the angles meet at one point in the centre of the circle. The measure of each of the angles is taken from the centre of the circle. These angles are called *central angles*. Each central angle has its vertex at the centre of the circle, and each ray radiates to a different point on the edge of the circle or circumference.

2. Distribute copies of BLM 7.SS.1.3: Cut-outs for Angles of Different Measures, and have groups carry out the following investigation:
- Each group will need one of each of the differently partitioned circles (halves, thirds, quarters, sixths, eighths, and twelfths). Students can share the circles within their group to even out the number of pieces each student will work with (e.g., thirds and quarters, halves and sixths).
 - Each student accurately measures the angles in the sections and neatly records the angle measures inside each section. Students then carefully cut out each section.
 - Have students combine pieces with angles of different sizes to form circles, and calculate the sum of the angles of the sections that complete the circles. Then repeat the process, constructing a number of circles with central angles of different sizes.
 - After an appropriate time, reassemble as a class, and ask students to share what they have discovered during this investigation. If you did not introduce the term *central angle* earlier, do so now. There are interesting relationships in circles. Ask students what they can conclude about the measures of central angles in a circle (e.g., the sum of the central angles is 360°). Note the connection between angles and circles. Angles are measured as fractions of circles. Each degree is $\frac{1}{360}$ of a circle. Have students add notes to their math journals.

Variations:

- If the technology and skills are available, use computer software to draw, measure, and calculate the sum of angles. Computer applets or games may also be used.

Sample Website:

Computer applets are available on the following websites:

Math Open Reference. *Angles*. 2009.

www.mathopenref.com/tocs/anglestoc.html.

_____. *Circles*. 2009. www.mathopenref.com/tocs/circlestoc.html.

- Have students find the measure of angles between different points on marked circles used in everyday objects (e.g., degrees between points on a compass, minutes or hours on a clock, positions on dials to measure temperature or speed). Results could be displayed in posters, with the measures of the angles between the points, and the sum of all the angles.
- Play a game in which students find the missing angle. Present a circle with one or more central angles. Students determine the measure of the remaining angle. The questions can also be used as Entry Slips or Exit Slips.



Observation Checklist

- Listen to and observe students' responses to determine whether students can do the following:
 - Explain, using an illustration, that the sum of the central angles of a circle is 360° .
 - Visualize central angles.
 - Use mental mathematics and estimation strategies to solve problems.

Suggestions for Instruction

- **Explain, using an illustration, that the sum of the central angles of a circle is 360° .**
- **Solve a contextual problem involving circles.**

Materials:

- BLM 7.SS.1.4: Hinge Templates for Making Angles
- scissors
- push-pins (to fasten the hinges)
- corrugated cardboard (on which to pin the centre of the circle)
- protractors
- number cubes, multi-sided number cubes, or spinners
- blank paper
- pencils
- string (optional)
- masking tape or chalk (optional)
- computer software (optional)

Organization: Pairs, whole class

Procedure:

1. Have pairs of students take turns building a circle from joined angles and calculating the sum of the angles. A suggested procedure follows:
 - a) Students throw a number cube to determine who makes the first angle, and then throw it again to indicate the numbers of angles (turns) to make. Students place blank paper on the cardboard, mark a centre point for the circle, and push a push-pin through the hinge to keep it in the centre of the circle.
 - b) The first person marks the edge of the hinge, opens the angle to a desired size, marks the position of the angle, and uses a protractor to measure the angle formed.
 - c) The second person records the angle and keeps a running sum of the angle measures.
 - d) The partners then switch roles. The second person begins from the last mark, forms an angle, marks the edge point, and measures the angle. The first person records the angle measure and adds the measure to the sum of the angles.
 - e) Partners continue switching roles until they have returned to the starting point or have formed the designated number of angles.
 - f) Students record the sum of the angles and perform another round.
2. Meet as a class, and have students report on the sums of the central angles that were obtained during the investigation. Compare the sums of the angles for each circle. Ask why the sums are close to, but not exactly, 360° , and what changes could be made to the procedure to increase accuracy. Sources of error could include errors in lining up and marking the hinges, in using the protractor, or in making calculations, variations in the thickness of pencil lines or the position on the hinge used for marking, and so on. If there is sufficient interest, and time is available, challenge students to repeat the investigation and try to eliminate the sources of error.
3. Present the following problem for students to solve:

A pizza was sitting on top of the stove. Jack cut out a piece of pizza and ate it. The central angle of the missing piece was 45° . Lisa came by, sliced some pizza, ate it, and left. The central angle of the remaining pizza was 90° . How much of the pizza did Lisa eat?

Variation:

- Investigate the sum of central angles using computer applets.

Sample Website:

Computer applets are available on the following website:

Math Open Reference. "Central Angle." *Circles*. 2009.
www.mathopenref.com/circlecentral.html.

Drag a point on the circumference to make central angles of different sizes.



Observation Checklist

- Listen to and observe students' responses to determine whether students can do the following:
 - Explain, using an illustration, that the sum of the central angles of a circle is 360° .
 - Solve a contextual problem involving circles.
 - Reason mathematically to solve problems.

Suggestions for Instruction

- **Illustrate and explain that the diameter is twice the radius in a circle.**
- **Illustrate and explain that the circumference is approximately three times the diameter in a circle.**
- **Draw a circle with a given radius or diameter with or without a compass.**

Part A:

Materials:

- math journals
- materials to mark a trail as a large circle is formed (e.g., sidewalk chalk for hard surfaces, a stick for gravel or soil, a bag of flour, puffed rice, or popcorn for lawns, books, self-stick notes, or scraps from a hole puncher for indoor floors)

Organization: Whole class, small groups (of five students)

Procedure:

Review that the sum of central angles is 360° , and develop definitions of the terms *radius*, *circle*, and *circumference* by constructing circles, as described below.

1. Have students do the following:
 - a) sketch an angle, making the rays fairly long. Label the angle $\angle ABC$. Write the approximate measure of the angle near the vertex.

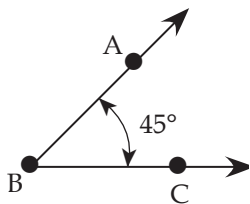

- b) Add two adjacent angles that each share an arm of the original angle and the vertex B. To label the new angles, add the points D and E. There are now four adjacent angles.

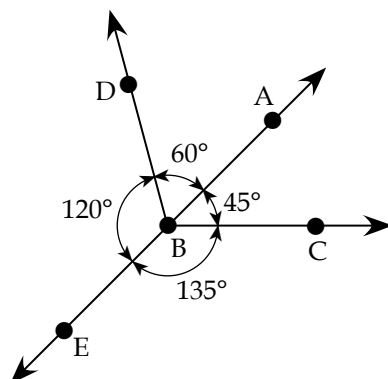

- c) Estimate the measure of each angle. Add the measures of the central angles. Determine whether they are close to 360° , and if not, explain why not.
- Have students draw a circle that passes through the arms of each angle. Then have them ask a partner to rate the roundness of the circle on a scale of 1 to 10.
 - Together with students, describe the criteria for a perfect circle. For example, the distance from the centre to the outside of the circle must always be same. Inform students that distance is called a *radius*. The measure for every radius of the same circle is identical. In fact, a *circle* is the set of points on a flat surface equal distances from a fixed point. The distance around those points (or the perimeter of the circle) is called the *circumference*.
 - Have each student make a math journal entry to define the terms *radius*, *circle*, and *circumference*.
 - Place students into groups of five. Have each group make a plan for creating a large nearly perfect circle (outdoors, in the gymnasium, or wherever space is available). Five students may make a circle with a diameter of 12 m or more, so ensure there is sufficient space for the class. Inform groups of the materials that will be available to them, and discuss the cleanup requirements. If students are having difficulty getting started, or think only of holding hands and spreading out, suggest they think of forming a radius. Students holding hands at arm's length can create quite a long radius. The centre person must be anchored securely to avoid being pulled out of position as the students forming the radius pivot around the centre. The last person can leave a trail for the circumference. Alternatively, make one large circle, have five or six students form the radius, and ask the other students to stand as markers around the circumference as the circle is formed.

6. When students have completed the circle, have them carefully step outside their circle and evaluate it. Recalling the power and beauty that can exist in discovering patterns, ask students to relate the radius of the circle to its circumference. Measuring the circumference in terms of the radius is a good way to do this. Have students do the following:

- Clearly mark a starting point on the circle.
- Line up the radius along the circumference, beginning at the starting point.
- Fold the radius over on itself until it returns to the starting point, counting the number of radii at each fold.

Have students share how many lengths of the radius the circumference of their circles is (approximately six). Have students make larger and smaller circles and test the relationship between the circumference and the radius.

7. Return indoors and have students make a math journal entry about what they learned in this learning activity.

Part B:

Materials:

- math journals
- corrugated cardboard, large paper, or other media on which to draw large circles
- string or light-gauge wire
- push-pins or nails with a large head
- compasses and pencils
- rulers, metre sticks, tape measures, and trundle wheels

Organization: Pairs or small groups

Procedure:

In Part B of this learning experience, students build on what they learned in Part A to enable them to draw circles of a given radius. They also learn about diameter and its relation to the radius and the circumference of a circle.

1. Review what students have written in their math journals about radius, circle, circumference, and how to build a perfect circle. Have them use their math journals to sketch a rough circle and draw two radii for that circle. Point out that they have drawn a central angle. By drawing more radii, they add more central angles. Ask students to draw a circle with two radii that are perfectly lined up with each other. They form an angle of 180° . This arrangement of radii is the *diameter* of the circle. Have students do the following:
- Describe the diameter of a circle. It is a straight line passing through the centre of the circle.
 - Describe the relationship between the radius and the diameter. The diameter is twice as long as the radius, $d = 2r$. (In Part A, the relationship between the radius and the circumference was found to be $\sim 6r = C$.)

- Predict the relationship between the diameter and the circumference.
 - Find a way to test the prediction.
 - Make a math journal entry to define *diameter*.
2. Direct students to the materials available to make large circles. Explain that their task is to develop a method to draw circles of a given radius or diameter. The circle size can be determined by the teacher, by a partner, or by the students themselves. Have students make small and large circles. When students have had some time to explore, ask them to share their success stories and frustrations, so they can help each other and refine their methods. Some students may use string, and may need to learn to tie a slip knot. Some students may use a strip of cardboard with a hole for the centre and hole for a pencil. They may have creative ideas.
 3. Continue the exploration. Aim for producing circles of a specific radius or diameter. Have students compare the size of the circle drawn to the intended size by measuring the radius and/or diameter with a ruler or a metre stick. If possible, also investigate the relationship between the length of the diameter and the circumference to test the predictions that were made.
 4. After students have had sufficient time to explore, congratulate them on their success. They will have invented some effective methods to draw circles accurately, especially large ones.
 5. Introduce students to the compass in their geometry kits, and show them how to use it. The metal point is held at the centre of the circle, and the pencil point will form marks along the circumference as it revolves around the centre point. The distance between the metal point and the pencil point will be the radius. Have them draw multiple circles of different sizes to perfect the technique.
 6. To end the class, have students draw two circles in their math journals. Specify the radius for one of the circles, and the diameter for the other. Ask them to comment on anything they found out about the relationship between the diameter and the circumference.



Observation Checklist

- Listen to and observe students' responses to determine whether students can do the following:
 - Illustrate and explain that the diameter is twice the radius in a circle.
 - Illustrate and explain that the circumference is approximately three times the diameter in a circle.
 - Draw a circle with a given radius or diameter with or without a compass.

Suggestions for Instruction

- **Illustrate and explain that the circumference is approximately three times the diameter in a circle.**
- **Explain that, for all circles, pi (π) is the ratio of the circumference to the diameter $\left(\frac{C}{d}\right)$, and its value is approximately 3.14.**

Materials:

- compasses and pencils
- rulers, metre sticks, tape measures, and trundle wheels
- measuring tape
- string, ribbon, or light-gauge wire
- push-pins
- corrugated cardboard
- circular objects or cylinders
- tool for finding the centre of circles (optional)
- BLM 7.SS.1.5: A Table to Compare Measures of Circles (optional)
- computers and spreadsheets (optional)

Organization: Small groups or whole class

Procedure:

In this learning experience, students focus on comparing the radius, diameter, and circumference of circles in an effort to discover pi, the ratio of the circumference to the diameter $\left(\frac{C}{d}\right)$.

1. Have students quickly review what they have learned about central angles, radius, diameter, and circumference, and their relationships, and about how to draw circles.
2. Explain that students will now use a variety of circles and circular objects and accurately measure their radius, diameter, and circumference to find a famous and useful relationship between the measures.

Inform students there are several ways to measure circumference, such as the following:

- Wrap a measuring tape around the circumference of a circle.
- Wrap a string or a ribbon around the circumference, and then measure the string or ribbon.
- Mark a starting point on the circle and roll the circle along a ruler, returning to the starting point.

- Roll the circle along a paper and mark the starting and ending points. Connect the points with a line, and measure the line.

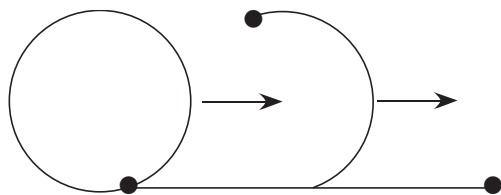

To find the centre of a circle, students can put the vertex of a right angle at a point along the circumference, and mark where the arms of the right angle cross the circumference. Joining these two marks creates a diameter of the circle. Repositioning the right angle approximately a quarter way around the circle and repeating the process will create another diameter. The point where the two diameters cross is the centre of the circle. Knowing the centre of the circle allows students to measure the radius and the diameter.

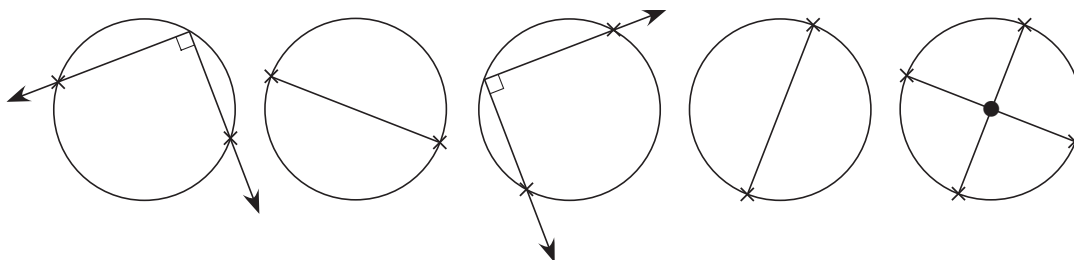

Note: Rolling out the line of the circumference is a useful strategy, as students can then measure the diameter and physically place the diameter over the line and see how many diameters long the line is. This requires no calculation.

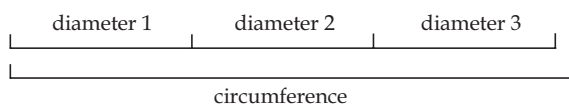

- Distribute copies of BLM 7.SS.1.5: A Table to Compare Measures of Circles, or have students create their own tables.
- Ask students to find circular objects of various sizes in the classroom or school, accurately measure the radius, diameter, and circumference of the objects, and record the required data. Have them include large circles (e.g., the centre circle on the basketball court) available in the school. Have students record and calculate the ratios and look for any consistent relationships.

5. Reassemble as a class and discuss students' findings. Students' measurements will not be completely accurate, so the calculations to decimal places will not be consistent. Nevertheless, students should have found that, regardless of the size of the circle, the circumference is always a little longer than three diameters of that circle ($C = 3d$ and a little more). If students have measured very carefully, they should have calculated values between 3.1 and 3.2. Explain that this relation $\left(\frac{C}{d}\right)$ is a very important mathematical constant. It is commonly approximated as 3.14, and is termed *pi* (π). It is important that students recognize that pi is not so much a special number as it is a special relationship, the relationship of the circumference of a circle divided by its diameter. (For more information on pi, refer to the Background Information.) **Note:** Remember to celebrate Pi Day (March 14).

Variation:

- Use spreadsheets to enter required data and calculate the value of the relations.



Observation Checklist

- Listen to and observe students' responses to determine whether students can do the following:
 - Illustrate and explain that the circumference is approximately three times the diameter in a circle.
 - Explain that, for all circles, pi is the ratio of the circumference to the diameter $\left(\frac{C}{d}\right)$, and its value is approximately 3.14.

Suggestions for Instruction

- **Solve a contextual problem involving circles.**

Materials:

- coloured paper on which to print problems
- scissors
- tape
- math journals
- computers for publishing (optional)

Organization: Small groups, whole class

Procedure:

In this learning activity, students work in groups to review what they have discovered about the relationships in circles, what the relationships mean, and the different notations for recording those relationships.

1. Challenge students to record the relationships in circles in as many equivalent ways as they can. They can include words, diagrams, and mathematical symbols. Considering equivalent values using opposite operations will be helpful.
2. Have groups create small posters with ideas such as the following:
 - The sum of the central angles always equals 360° .
 - If I know the radius, I can know the diameter too, because $d = 2r$.
 - If you tell me the diameter, I can tell you the radius $\left(r = \frac{1}{2}d\right)$.
 - $\frac{C}{d} =$ a constant pi (π), and pi has an approximate value of 3.14.
 $\frac{C}{d} \approx 3.14$, so $3.14 \cdot d \approx C$ and $\frac{C}{3.14} \approx d$. If I know the circumference, I can find the diameter, and vice versa.
 - $2r$ can replace d in every relation, so $3.14 \cdot 2 \cdot r \approx C$ or $6.28r \approx C$. I can figure out the circumference of a circle if I know the radius of the circle.
3. After giving groups sufficient time to work on their posters, post their work and have a Gallery Walk, giving students an opportunity to compare the representations in the different posters. Reassemble as a class and share observations.

4. Supply students with the following sample problem, and ask them to work in their groups to solve it:

Your sister is preparing for her wedding. You're at the store with your mom, who is picking up last-minute items that are needed to finish the decorating. The list includes a special lace border to go around the round table on which the desserts will be displayed. The measurement given for the table is 1 metre in diameter. "Oh no!" your mother sighs. "I've been given the wrong information. The border goes around the table, not across it. How am I supposed to know how much lace border to buy?" "Never fear, mother," you say. "The math constant pi holds the answer to your problem. Give me a minute, and I will tell you the length of the border you need to buy to go around a table with a diameter of 1 metre." What is the answer your mother needs?

5. Have students use the relationships on their posters to help them prepare contextual problems about finding the various measurements of circles when only one other measurement is given. Ask groups to be imaginative and creative in the problems they write and the ways in which they present the problems. Have them supply the solutions to their problems, concealed under a flap or using some other method. Groups may wish to create problems centred on a particular theme or event. Remind students that circles can be unravelled. They can roll a circle to measure its circumference. The circumference of the circle equals the distance the outside of a circle can travel in one revolution. So, students can compare the distance travelled in one revolution for circles of different sizes, or calculate the revolutions required to travel a certain distance using circles of different sizes. If a circle is peeled in layers, each successive strip will be a little smaller. If the thickness of the strips remains constant, students could solve problems such as figuring out the diameter of a rolled hose compared to its length.
6. Have students solve the problems created by their classmates, and verify their solutions. Have students write a math journal entry commenting on their success in solving the problems. Also have them comment on which types of problems they preferred, and which problems they found more difficult.

Variations:

- Provide scaffolding in the form of templates for students who may have trouble composing appropriate problems.
- Have students publish their problems using computer software.
- Serve a variety of pie at the pi celebration (e.g., pizza pie, spinach pie).



Observation Checklist

- Listen to and observe students' responses to determine whether students can do the following:
 - Solve a contextual problem involving circles.

NOTES

Shape and Space (Measurement) (7.SS.2)

Enduring Understanding(s):

Many geometric properties and attributes of shapes are related to measurement.

The area of a rectangle can be used to develop the formula for the area of other shapes.

General Learning Outcome(s):

Use direct or indirect measurement to solve problems.

SPECIFIC LEARNING OUTCOME(S):	ACHIEVEMENT INDICATORS:
<p>7.SS.2 Develop and apply a formula for determining the area of</p> <ul style="list-style-type: none">■ triangles■ parallelograms■ circles. <p>[CN, PS, R, V]</p>	<ul style="list-style-type: none">→ Illustrate and explain how the area of a rectangle can be used to determine the area of a triangle.→ Generalize a rule to create a formula for determining the area of triangles.→ Illustrate and explain how the area of a rectangle can be used to determine the area of a parallelogram.→ Generalize a rule to create a formula for determining the area of parallelograms.→ Illustrate and explain how to estimate the area of a circle without the use of a formula.→ Apply a formula for determining the area of a circle.→ Solve a problem involving the area of triangles, parallelograms, or circles.

PRIOR KNOWLEDGE

Students may have had experience with the following:

- Demonstrating an understanding of the area of regular and irregular 2-D shapes by
 - recognizing that area is measured in square units
 - selecting and justifying referents for the units cm^2 or m^2
 - estimating area by using referents for cm^2 or m^2
 - determining and recording area (cm^2 or m^2)
 - constructing different rectangles for a given area (cm^2 or m^2) in order to demonstrate that many different rectangles may have the same area

- Solving problems involving single-variable (expressed as symbols or letters), one-step equations with whole-number coefficients, and whole-number solutions.
- Designing and constructing different rectangles given either perimeter or area, or both (whole numbers), and drawing conclusions.
- Demonstrating an understanding of measuring length (mm) by
 - selecting and justifying referents for the unit mm
 - modelling and describing the relationship between mm and cm units, and between mm and m units
- Describing and providing examples of edges and faces of 3-D objects, and sides of 2-D shapes, that are
 - parallel
 - intersecting
 - perpendicular
 - vertical
 - horizontal
- Identifying and sorting quadrilaterals, including
 - rectangles
 - squares
 - trapezoids
 - parallelograms
 - rhombuses
 according to their attributes.
- Demonstrating an understanding of the relationships within tables of values to solve problems.
- Representing and describing patterns and relationships using graphs and tables.
- Representing generalizations arising from number relationships using equations with letter variables.
- Demonstrating an understanding of angles by
 - identifying examples of angles in the environment
 - classifying angles according to their measure
 - estimating the measure of angles using 45° , 90° , and 180° as reference angles
 - determining angle measures in degrees
 - drawing and labelling angles when the measure is specified
- Developing and applying a formula for determining the
 - perimeter of polygons
 - area of rectangles
 - volume of right rectangular prisms

- Constructing and comparing triangles, including
 - scalene
 - isosceles
 - equilateral
 - right
 - obtuse
 - acute
 in different orientations.
- Describing and comparing the sides and angles of regular and irregular polygons.

For more information on prior knowledge, refer to the following resource:

Manitoba Education and Advanced Learning. *Glance Across the Grades: Kindergarten to Grade 9 Mathematics*. Winnipeg, MB: Manitoba Education and Advanced Learning, 2015. Available online at www.edu.gov.mb.ca/k12/cur/math/glance_k-9/index.html.

RELATED KNOWLEDGE

Students should be introduced to the following:

- Demonstrating an understanding of oral and written patterns and their corresponding relations.
- Constructing a table of values from a relation, graphing the table of values, and analyzing the graph to draw conclusions and solve problems.
- Demonstrating an understanding of preservation of equality by
 - modelling preservation of equality, concretely, pictorially, and symbolically
 - applying preservation of equality to solve equations
- Explaining the difference between an expression and an equation.
- Evaluating an expression given the value of the variable(s).
- Modelling and solving problems that can be represented by one-step linear equations of the form $x + a = b$, concretely, pictorially, and symbolically, where a and b are integers.
- Modelling and solving problems that can be represented by linear equations of the form
 - $ax + b = c$
 - $ax = b$
 - $\frac{x}{a} - b, a \neq 0$
 concretely, pictorially, and symbolically, where $a, b,$ and $c,$ are whole numbers.

- Demonstrating an understanding of circles by
 - describing the relationships among radius, diameter, and circumference of circles
 - relating circumference to pi
 - determining the sum of the central angles
 - constructing circles with a given radius or diameter
 - solving problems involving the radii, diameters, and circumferences of circles
- Performing geometric constructions, including
 - perpendicular line segments
 - parallel line segments
 - perpendicular bisectors
 - angle bisectors

BACKGROUND INFORMATION

Calculating Area

Before entering Grade 7, students constructed rectangles of a given area, and generalized a rule for determining the area of a rectangle. In Grade 7, students build on their knowledge of rectangles to generalize rules for determining the area of a triangle and of a parallelogram. They also use their familiarity with rectangles to find the area of a circle. Determining area is a useful skill for identifying and comparing the sizes of objects of different shapes, whether they are circular, rectangular, or triangular. There are many practical applications for determining area (e.g., identifying which size or shape of pizza is a better buy, determining the cost of flooring). Determining area is also a prerequisite skill for determining the volume of prisms and cylinders in later grades.

To make generalizations regarding area, students must have a good conceptual understanding of what area is, and of how to find the area of a rectangle. The formula $l \cdot w$ is a way of counting the squares contained in the area of a rectangle. It represents area as an array of squares, and provides a way of counting them. That is, the formula $l \cdot w$ represents the number of squares in each row multiplied by the number of rows. If necessary, rebuild these understandings before having students develop rules regarding the area of triangles and parallelograms.

To begin, review types of quadrilaterals and classifications of triangles, to ensure students have vocabulary to communicate clearly about their learning. The ability to identify the base and height of shapes is also important for clear communication about shapes. Identifying base and height is also required to develop and apply formulas. Any flat side of an object can serve as its base. The base in any situation depends on the orientation of the object. Height is measured in relation to the base; therefore, an object may have different heights, depending on its orientation. Height is the distance between the highest point of the object and its base. It is measured along a line that is perpendicular to the base.

Provide students with opportunities to explore methods of finding the areas of figures and to discover the relationships between the figures and rectangles. As students gain an understanding of the concepts and see the relationships, the generalization of $b \cdot w$ will become apparent as the generalized formula for finding the area of a parallelogram. As they observe that two identical triangles form a parallelogram, they will understand that $\frac{1}{2}b \cdot h$ identifies the area of a triangle. When a rectangle is halved along a diagonal, all the resulting triangles are right triangles. It is clear that their area is one-half of the area of the rectangle, or $\frac{1}{2}l \cdot w$. The length and width are obtained by measuring the sides of the rectangle. For a right triangle, the area can be calculated by measuring the sides of the triangle next to the right angle.

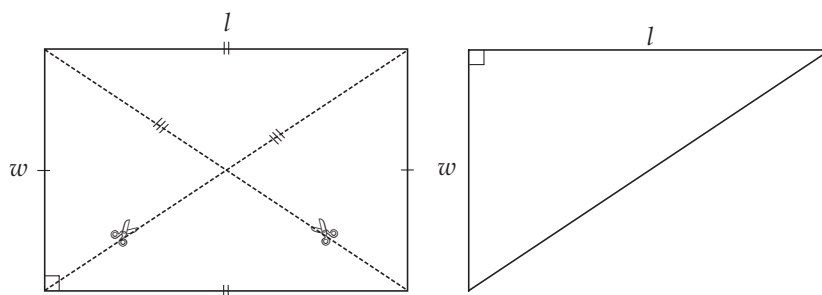

When a parallelogram is halved along a diagonal, two triangles of different sizes and shapes may be created, depending on the diagonal used to halve the parallelogram. It is still evident that the area of either triangle is one-half the area of the parallelogram, but neither the area of the parallelogram nor the triangle can be calculated by measuring the sides. The base and the height of the figures must be determined in order to calculate the area.

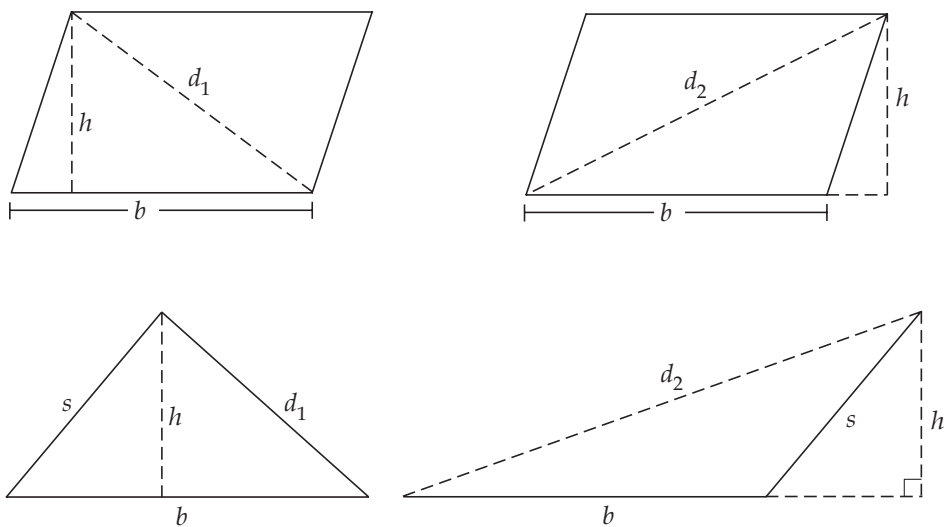

Relating the properties of parallelograms to those of rectangles is a way of establishing the concept of base \times height as the way to determine the area of a parallelogram. Any two identical triangles can be arranged to form a parallelogram. The triangle is related to the parallelogram, and the parallelogram is related to the rectangle. There is an advantage to studying the area of parallelograms before studying the area of triangles, because the use of base and height in relation to area has already been established and there is no need to separate right triangles from other triangles.

When a circle is sectioned through the centre, and the pieces are rearranged so that the orientation of the centre alternates between pointing up and pointing down, the pieces will form an approximate rectangle. The approximate rectangle can be used to estimate the area of a circle, and to explain the formula for finding the area of a circle.

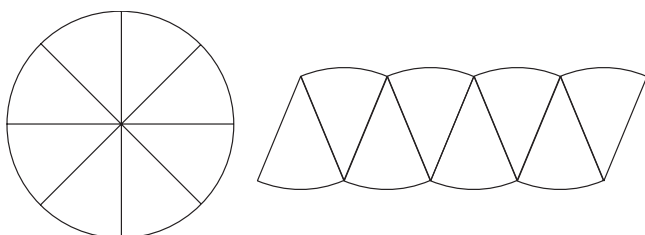

When students build their own generalizations from their own experiences, they will understand the connections in formulas. Building these connections provides the best opportunities for students to remember formulas and to apply them correctly. If students forget a formula, they are in a position to rebuild it, test it, and carry on using it.

The suggested learning experiences that follow are closely related. Students are sent on three missions to discover methods of calculating areas of parallelograms, triangles, and circles. Each endeavour is based on knowledge of the rectangle. The final learning activity engages students in a problem-solving party.

MATHEMATICAL LANGUAGE

area	rectangle
base	square units
formula	triangle (obtuse, right, acute, scalene, equilateral, isosceles)
height	vertex
horizontal	vertical
intersecting	width
length	
parallel	
parallelogram	
perpendicular	
polygon	
quadrilateral (square, rectangle, rhombus, trapezoid, parallelogram)	



Assessing Prior Knowledge

Materials:

- BLM 7.SS.2.1: The Area of Rectangles (Assessing Prior Knowledge)
- demonstration board
- paper for writing clues (one-quarter sheets)
- two long pencils, pens, or straws (for each student)
- BLM 5–8.21: Isometric Dot Paper (optional)
- BLM 5–8.22: Dot Paper (optional)
- geoboards (optional)

Organization: Groups of varying sizes, whole class, individual

Procedure:

1. Review the vocabulary terms *perpendicular*, *parallel*, *intersecting*, *vertical*, and *horizontal* by playing a Simon Says type of game.
 - The game can be played with a group of any size. Choose a group size that is best for your class situation.
 - As Simon gives directions, students use their arms or a pair of pencils, pens, or straws to demonstrate the formation.
 - The phrase “Simon says” must preface the direction. For example, “Simon says, show parallel lines.” Anyone not showing the lines correctly is out for the round.
 - If the phrase “Simon says” does not preface the direction, anyone performing the demonstration is out.
 - The last person remaining in the game wins, or becomes the new Simon.
2. Review types of quadrilaterals and classifications of triangles by playing with riddles.
 - The game can be played with a group of any size. Choose a group size that is best for your class situation.
 - Include the following quadrilaterals and triangles:
 - quadrilaterals: rectangles, squares, trapezoids, parallelograms, and rhombuses
 - triangles: scalene, isosceles, equilateral, right, obtuse, and acute

- Assign each student one or more quadrilaterals and/or triangles (different ones for each student).
 - Ask students to consider the attributes of a given shape, and then write four clues from which their classmates can identify the shape.
 - Students fold a sheet of paper in half. They write the clues outside the fold, and the name of the shape, accompanied by an accurate diagram, inside the fold.
 - Have students take turns offering their clues to the group.
 - When individuals identify a shape correctly, they get possession of the card, or earn x number of points, and so on.
3. Through a whole-class discussion focused on quadrilaterals and triangles, review the concepts of base and height using objects and diagrams.
 4. To review what students know about calculating the area of rectangles, distribute copies of BLM 7.SS.2.1: The Area of Rectangles (Assessing Prior Knowledge), and have students complete the tasks individually.

Variations:

- Have students review shapes with a Pictionary type of game. The designer draws the designated quadrilateral or triangle, and group members guess its name. The student who guesses correctly becomes the next designer. Add competition to the game by supplying a set of cards with the shape names, and having groups compete to be the first to complete designs of the set of shapes.
- Use geoboards, geoboard templates, or dot paper to demonstrate the different shapes and to explore various sizes of rectangles with the same area. (See BLM 5–8.21: Isometric Dot Paper and BLM 5–8.22: Dot Paper.)

Observation Checklist

- Listen to and observe students' responses to determine whether students can do the following:
 - Identify different classifications of triangles and quadrilaterals according to their attributes.
 - Identify parallel, perpendicular, intersecting, horizontal, and vertical lines.
 - Identify the base and height of diagrams.
 - Demonstrate understanding that area is measured in square units.
 - Calculate the area of rectangles.

Suggestions for Instruction

- **Illustrate and explain how the area of a rectangle can be used to determine the area of a parallelogram.**
- **Generalize a rule to create a formula for determining the area of parallelograms.**
- **Solve a problem involving the area of triangles, parallelograms, or circles.**

Materials:

- grid paper
- rulers
- scissors
- tape
- calculators
- math journals
- geoboards and elastics (optional)
- BLM 5-8.22: Dot Paper (optional)
- BLM 5-8.9: Centimetre Grid Paper (optional)

Organization: Investigative teams, whole class, individual or pairs

Procedure:

1. Assign students the mission of using their investigative and mathematical reasoning skills to discover and provide the world with a method that will quickly determine the area of any parallelogram, of any dimension, in any situation. Allow students to conduct their own investigation, but provide whatever hints are required to keep them on track.
2. The first step is to identify a strategic plan for the mission. Preliminary stages could include the following:
 - a) Consider how to identify a parallelogram, varieties of parallelograms, and similarities and differences between parallelograms. Identify the attributes of the parallelograms for which to collect data.
 - b) Examine the initial findings of areas for different parallelograms, including parallelograms with the same area but different shapes. Identify the attributes of the parallelograms to measure and investigate.
 - c) Look for connections between the known and the unknown. How to determine the area of a rectangle is a known. Is there a similarity between rectangles and parallelograms that may help guide the investigation? (A parallelogram can be divided and reassembled as a rectangle. The reassembly does not change the length or height of the figure. The base is removed from one end of the figure and reattached at the opposite end. The height of the figure does not change, just the interior angles change.)

Cut along the dotted line and tape the section to the right vertex to form a rectangle.

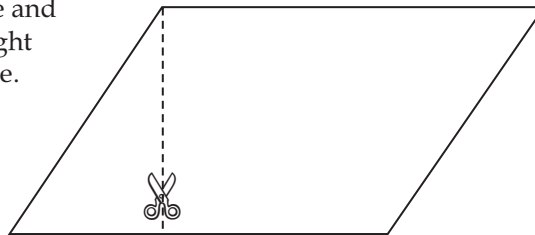

- d) Identify relationships between a parallelogram's attributes and its area, and search for a pattern. Look for a connection between the length of the base and the height that equals the count of the squares.
3. After identifying a method to determine the area of any parallelogram, of any dimension, in any situation, students test it for a variety of parallelograms. Encourage students to base their formulas on lengths of the base and the height. If their formula works consistently, the mission is accomplished.
4. Hold a debriefing session with the class, asking students to share their strategies and findings.
 - a) In the discussion, include situations in which the area of a parallelogram is known and the length of the base or height of the parallelogram needs to be determined.

- b) Discuss the value of knowing the length of the side, and whether the measurement is useful in finding the area.
 - c) Ask whether a parallelogram can be accurately reproduced given the area and the length of the base or height.
5. Have students work individually, or in pairs, to create one or two parallelogram problems for their partners to solve.
 6. Give students a set of problems, with solutions concealed. Working out a solution verifies that the creator of the problem understands what he or she is doing, and that the problem “works.” Attempting to work out a solution may indicate the problem requires revision, and provides feedback for the problem solver.

Examples of Problems:

- Draw two different parallelograms that have an area of x square units, or a base of x units and an area of x units.
- Provide drawings of parallelograms from which to calculate area.
- Provide dimensions for two parallelograms and ask which parallelogram has the larger area.

Variations:

- If students become stuck in their investigation, provide them with a diagram of a parallelogram on centimetre grid paper and provide enough prompts for the discovery to be made. (See BLM 5–8.9: Centimetre Grid Paper.)
- Geoboards provide an easy way to investigate parallelograms of the same base and height, but with different interior angles. Investigate the change from a rectangle to many different parallelograms with the same area by systematically shifting the base one unit to the right of the top. This looks interesting on paper as well, and it is self-evident that the dimensions for the base and height have not changed. It also provides an illustration of circumstances in which the height of the parallelogram is not obvious, and must be measured outside the parallelogram.



Observation Checklist

- Listen to and observe students’ responses to determine whether students can do the following:
 - Illustrate and explain how the area of a rectangle can be used to determine the area of a parallelogram.
 - Generalize a rule to create a formula for determining the area of parallelograms.
 - Solve a problem involving the area of triangles, parallelograms, or circles.

Suggestions for Instruction

- **Illustrate and explain how the area of a rectangle can be used to determine the area of a triangle.**
- **Generalize a rule to create a formula for determining the area of triangles.**
- **Solve a problem involving the area of triangles, parallelograms, or circles.**

Materials:

- file from the investigation of parallelograms
- grid paper
- rulers
- scissors
- tape
- calculators
- math journals
- geoboards and elastics (optional)
- BLM 5–8.22: Dot Paper (optional)

Organization: Investigative teams (from previous learning activity), whole class, individual or pairs

Procedure:

This learning experience on determining the area of a triangle is designed to follow the previous learning activity on determining the area of parallelograms.

1. Inform students they have been assigned a new mission that requires investigators with mathematical reasoning skills. This time, the world is in need of a method or formula that will quickly determine the area of any triangle of any classification, of any dimension, in any situation. Their mission is to discover the formula. Once again, allow students to conduct their own investigation, but provide whatever hints are required to keep them on track. A general suggested protocol is outlined below. For more detail, refer to the procedure for finding the area of parallelograms (in the previous learning experience).
2. The first step is to develop a strategic plan. This may include the following:
 - a) Identify classifications of triangles, their similarities and differences, and the attributes for which to collect data.
 - b) Collect some initial data about area for different triangles, including triangles with the same area, but different shapes. Identify how to measure the height of a triangle. Choose which attributes to measure for the investigation.

- c) Look for connections between the known and the unknown. Look for similarities between triangles and parallelograms and rectangles. Similarities provide clues to help guide the investigation.

Example:

- Any two congruent triangles can be arranged to form a parallelogram. Therefore, their area must be $\frac{1}{2}$ the area of the parallelogram.

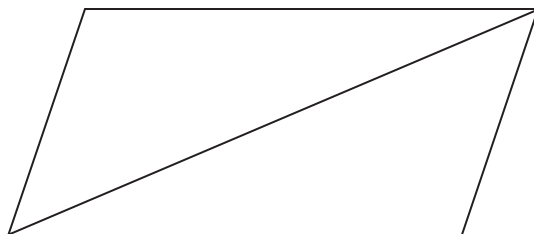

- Triangles also have bases and heights. A triangle can be enclosed within a rectangle of the same height and sharing the same base. A perpendicular line can be drawn from the highest vertex of the triangle to its base. The line divides both the triangle and the rectangle in two. The sides of the triangles become the diagonals of the two rectangles.
- Students can explore finding the area of different triangles, using computer applets.

Sample Website:

Computer applets are available on the following website:

Bogomolny, A. "Area of Triangle." *Interactive Mathematics Miscellany and Puzzles*. 1996–2011.

www.cut-the-knot.org/Curriculum/Geometry/AreaOfTriangle.shtml

Choose the colour option to make the relation more obvious.

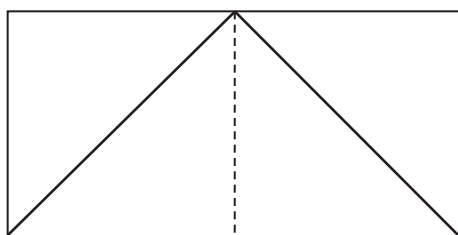

- The area of each triangle is $\frac{1}{2}$ the area of each rectangle; therefore, the area of the original triangle is $\frac{1}{2}$ the area of the original rectangle. The squares in the area of the triangle equal $\frac{1}{2}$ the number of squares in a rectangle with the same base and height. Using an array model to count the squares leads to the formula $\frac{1}{2}b \cdot h$.

3. Look for a relationship between the base and height of triangles, and their areas. Look for a mathematical relationship that will equal the area for a given triangle.
4. Identify a formula for determining the area of a triangle, and test it on a variety of triangles. If the formula works consistently, another useful formula has been discovered, and is ready for use.
5. Debrief as a class to discuss findings and strategies. For example, dividing a parallelogram through the diagonal creates two congruent triangles, and dividing through the opposite diagonal creates two different congruent triangles. Students may wish to discuss why that is so. What value is there in measuring the length of the sides of the triangle? Can a triangle be reproduced by knowing only the base and the height? Can a triangle be reproduced by knowing only the area, or the area and the base?
6. Have students work individually or in pairs to create problems and solutions related to determining the area of a triangle, and then exchange problems and find the solutions. These problems and solutions may be used as Exit Slips.

Variations:

- Explore the effect of varying the height and base measurements of a triangle or the area of the triangles. Also explore creating different triangles with the same area. Geoboards, paper templates of geoboards, or dot paper may be used. (See BLM 5–8.22: Dot Paper.)
- Explore the relationships between the height, base, and area of triangles using computer applets.

Sample Website:

Computer applets are available on the following website:

Math Open Reference. "Area of a Triangle." *Triangles*. 2009.

www.mathopenref.com/trianglearea.html.

This applet allows students to change the length of the base, the height of the triangle, or the measures of the angles, while the applet constantly measures the matching area.



Observation Checklist

- Listen to and observe students' responses to determine whether students can do the following:
 - Illustrate and explain how the area of a rectangle can be used to determine the area of a triangle.
 - Generalize a rule to create a formula for determining the area of triangles.
 - Solve a problem involving the area of triangles, parallelograms, or circles.

Suggestions for Instruction

- **Illustrate and explain how to estimate the area of a circle without the use of a formula.**
- **Apply a formula for determining the area of a circle.**
- **Solve a problem involving the area of triangles, parallelograms, or circles.**

Materials:

- BLM 7.SS.2.2: Circles for Estimating Area
- math journals
- grid paper
- rulers
- scissors
- glue or tape
- markers of different colours
- calculators

Organization: Individual or pairs, whole class, individual

Procedure:

In this learning experience, students investigate the area of a circle. Be prepared to use more than one class for the investigation and application, depending on the amount of time the students use for exploring and the depth of their exploration.

1. As an introductory problem, or as a closing exercise, present round pizzas (cut into even wedges) and rectangular pizzas (close in area, but not too close) or cut-outs of these, and ask students to compare the two pizzas and find out which shape of pizza is larger. Have students record evidence for their decision in their math journals.
2. Inform students their current mission is to find effective methods to approximate the area of circles.
3. Present students with one or more circles and ask them to approximate the area.
4. When students have a good estimate, ask them to use their math journals to note the procedure they followed. Then ask them to attempt to find more methods that work for them. Encourage students to steer their own investigation, connecting the known with the unknown.
5. As students work on their investigation, circulate among the class and observe. If students experience difficulty in their work, ask guiding questions or suggest an action. Their investigative methods may include the following:
 - a) Trace the circle onto grid paper and count the number of squares.

- b) Draw the smallest square the circle could fit into, calculate the area of the square, and determine some amount to deduct to compensate for the area of the square that does not include part of the circle.
- c) Draw the smallest square to contain the circle, and the largest square inside the circle (use the diagonals of the large square to indicate the position of the corners). Then think, the circle is larger than the small square and smaller than the large square, so the area of the circle must cover an area between the areas of both squares. The number midway between is a good approximation.
- d) Consider whether the circle could be transformed into a rectangle. Section a circle into four pieces and try arranging the pieces to approximate a rectangle, as illustrated below. (Colouring the circumference of the circle before beginning helps identify the orientation of the pieces.) Alternating the centre points between pointing up and pointing down elongates the circle. Halve each of the four pieces, and arrange the pieces to approximate a rectangle again. It becomes evident that the more times the sections are halved, the more the elongation resembles a parallelogram. Measuring the base and the height of this parallelogram will approximate the area of the circle.

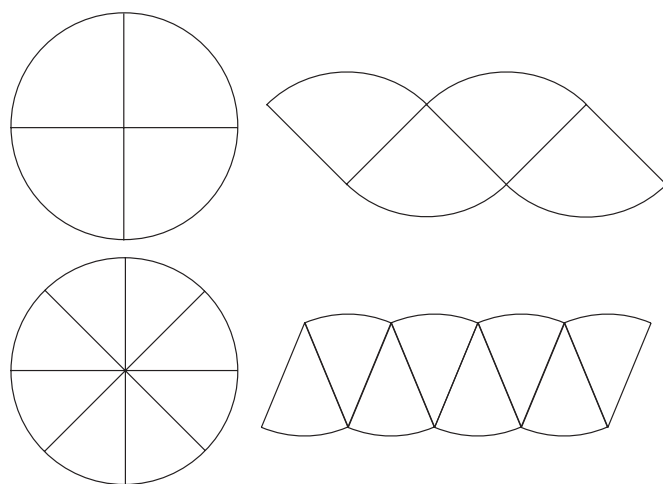

6. After students have had sufficient time to develop their investigative methods and have made some discoveries, reassemble as a class for a debriefing session. Discuss students' findings regarding the areas of the circles, and the methods they found most useful, or most accurate.



Observation Checklist

- Listen to and observe students' responses to determine whether students can do the following:
 - Illustrate and explain how to estimate the area of a circle without the use of a formula.
 - Apply a formula for determining the area of a circle.
 - Solve a problem involving the area of triangles, parallelograms, or circles.

Suggestions for Instruction

- **Solve a problem involving the area of triangles, parallelograms, or circles.**

Materials:

- rulers
- grid paper
- protractors
- paper for publishing problems
- calculators
- math journals or notebooks, or logs of completed problems
- art or craft supplies (optional)
- snacks for the party (optional)
- computers for publishing problems (optional)

Organization: Individual, pairs, or small groups

Procedure:

1. Planning

Have students think of contexts where parallelograms, triangles, and circles may appear in everyday situations (decide whether or not to exclude rectangles). Examples for parallelograms may include logo designs, personal flags, geometric art designs, optical illusions, tangrams, one half of gable roofs, and architectural designs.

Example:

The following website has a photograph of a building in the shape of a parallelogram along the Elbe River in Hamburg, Germany.

Stich, Mike. "Parallelogram." 22 May 2006. *flickr*.
www.flickr.com/photos/mdstich/357560359/.

2. Preparing the Problems

- a) Give students an opportunity to create diagrams, designs of structures, logos, artwork, puzzles, and so on, that involve only parallelograms, triangles, or circles, or combinations of these shapes.
- b) When the design projects are complete, have students use their designs as the subject to write problems whose solutions require calculating area and to provide a solution for each problem created.

Examples:

- Determine the square metres of glass required for windows in a building.
- Determine the square metres of material required for the different shapes in a flag, or in a piece of artwork.
- Create "three of these things belong" questions, where three parallelograms or triangles with different base and height combinations, or different interior angles, have the same area, and one has a different area.
- Create problems for combinations of all three shapes. The challenge is to find the shape with the different area.
- Include problems that require calculating area, and problems that supply area and require calculating bases, heights, radii, or circumference.

3. Solving the Problems

- a) When the projects are complete, students can share them with one another at a party. The focus of the party becomes solving various problems.
- b) Perhaps completed problems could be exchanged for drinks or snacks at the party (sign off each problem that has been exchanged).
- c) Assign greater value to problems that are more challenging.
- d) Agree on a definite number of problems to complete, or solve problems with an aim to accumulate a target number of square units, or have a contest to accumulate the greatest number of square units in problem answers.
- e) Students will be busy calculating many areas. Have fun.



Observation Checklist

- Listen to and observe students' responses to determine whether students can do the following:
 - Solve a problem involving the area of triangles, parallelograms, or circles.

NOTES

Shape and Space (3-D Objects and 2-D Shapes) (7.SS.3)

Enduring Understanding(s):

Many geometric properties and attributes of shapes are related to measurement.

While geometric figures are constructed and transformed, their proportional attributes are maintained.

General Learning Outcome(s):

Describe the characteristics of 3-D objects and 2-D shapes, and analyze the relationships among them.

SPECIFIC LEARNING OUTCOME(S):	ACHIEVEMENT INDICATORS:
<p>7.SS.3 Perform geometric constructions, including</p> <ul style="list-style-type: none"> ■ perpendicular line segments ■ parallel line segments ■ perpendicular bisectors ■ angle bisectors <p>[CN, R, V]</p>	<ul style="list-style-type: none"> → Describe examples of parallel line segments, perpendicular line segments, perpendicular bisectors, and angle bisectors in the environment. → Identify line segments on a diagram that are parallel or perpendicular. → Draw a line segment perpendicular to another line segment, and explain why they are perpendicular. → Draw a line segment parallel to another line segment, and explain why they are parallel. → Draw the bisector of an angle using more than one method, and verify that the resulting angles are equal. → Draw the perpendicular bisector of a line segment using more than one method, and verify the construction.

PRIOR KNOWLEDGE

Students may have had experience with the following:

- Describing and constructing rectangular and triangular prisms.
- Demonstrating an understanding of measuring length (mm) by
 - selecting and justifying referents for the unit mm
 - modelling and describing the relationship between mm and cm units, and between mm and m units

- Describing and providing examples of edges and faces of 3-D objects, and sides of 2-D shapes, that are
 - parallel
 - intersecting
 - perpendicular
 - vertical
 - horizontal
- Identifying and sorting quadrilaterals, including
 - rectangles
 - squares
 - trapezoids
 - parallelograms
 - rhombusesaccording to their attributes.
- Demonstrating an understanding of angles by
 - identifying examples of angles in the environment
 - classifying angles according to their measure
 - estimating the measure of angles using 45° , 90° , and 180° as reference angles
 - determining angle measures in degrees
 - drawing and labelling angles when the measure is specified
- Demonstrating that the sum of interior angles is
 - 180° in a triangle
 - 360° in a quadrilateral
- Constructing and comparing triangles, including
 - scalene
 - isosceles
 - equilateral
 - right
 - obtuse
 - acutein different orientations.

- Describing and comparing the sides and angles of regular and irregular polygons.

For more information on prior knowledge, refer to the following resource:

Manitoba Education and Advanced Learning. *Glance Across the Grades: Kindergarten to Grade 9 Mathematics*. Winnipeg, MB: Manitoba Education and Advanced Learning, 2015. Available online at www.edu.gov.mb.ca/k12/cur/math/glance_k-9/index.html.

RELATED KNOWLEDGE

Students should be introduced to the following:

- Developing and applying a formula for determining the area of
 - triangles
 - parallelograms
 - circles

BACKGROUND INFORMATION

The concepts of perpendicular and parallel surround us in everyday life. In Grade 5, in their study of 2-D shapes and 3-D objects, students identified examples of perpendicular and parallel sides, edges, and faces. They also identified examples of perpendicular and parallel line segments in the environment. Because Grade 5 students lack experience with measuring angles, the angle formed by perpendicular lines was identified as having “square” corners. In Grade 7, students will create parallel and perpendicular line segments and bisectors, as well as angle bisectors, using geometric constructions.

Geometric Constructions

Geometric constructions are connected to the Ancient Greeks and Euclidean geometry. They are different than drawings in that the only tools used in creating geometric constructions are a straightedge, a compass, and a pencil. Interesting connections exist between geometric constructions, art, and architecture in many different cultures. Parallel and perpendicular lines are also important to surveyors, designers, engineers, contractors, and people building just about anything.

Students may enjoy recreating geometric constructions. Knowing about various applications may provide students with an increased purpose and motivation for using a straightedge and a compass to create lines and bisectors.

Lines, Rays, and Line Segments

Lines, rays, and line segments are made up of sets of points that are straight and one-dimensional. Their only dimension is length.

- A *line* is a set of points that extends indefinitely in opposite directions.

Example:

The line \overleftrightarrow{AB}

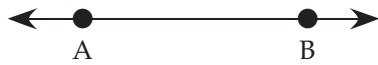

- A *ray* is a set of points that extends indefinitely in one direction.

Example:

The ray \overrightarrow{CD}

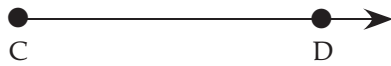

- A *line segment* is a set of points along a line with two finite endpoints.

Example:

The line segment \overline{EF} :

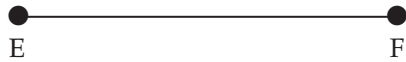

Lines, rays, and line segments can be parallel or intersecting. Lines that intersect at right angles are perpendicular lines.

- *Parallel lines* never meet; they are always the same distance apart. In diagrams, indicate parallel lines by marking an arrow on the line.

Example:

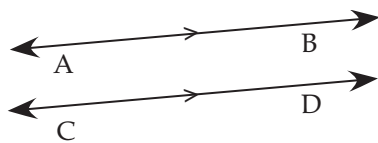

The symbol \parallel indicates that the lines are parallel, as in $\overleftrightarrow{AB} \parallel \overleftrightarrow{CD}$

- *Perpendicular lines* intersect at 90° angles. In diagrams, indicate perpendicular lines by drawing a small square where the lines join.

Example:

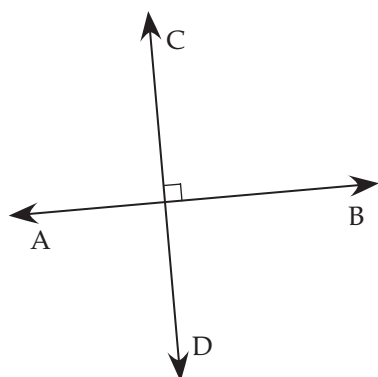

The symbol \perp indicates that the lines are perpendicular, as in $\overleftrightarrow{AB} \perp \overleftrightarrow{CD}$

Lines and angles can be bisected. In the word *bisectors*, *bi* means two and *sect* means to cut. When a line or an angle is bisected, it is cut into two pieces of equal size. We could say it is divided in half or divided down the middle.

Students will perform geometric constructions, including constructions of perpendicular bisectors and angle bisectors:

- A *perpendicular bisector* is a line, ray, or line segment that divides a line segment into two equal segments and is perpendicular to the original line, ray, or segment.
- An *angle bisector* is a line or ray that divides an angle into two angles of equal size.

Methods for creating each of these constructions are outlined in the learning experiences suggested for learning outcome 7.SS.3.

MATHEMATICAL LANGUAGE

angle	line segment
angle bisector	perpendicular
arc	perpendicular bisector
bisect	perpendicular lines
bisector	parallel
intersecting lines	parallel lines
line	ray



Assessing Prior Knowledge

Materials:

- BLM 7.SS.3.1: Parallel and Perpendicular Lines (Assessing Prior Knowledge)
- skipping ropes or other types of ropes (two ropes per group of six students)
- math journals or notebooks

Organization: Small groups (of six students), individual

Procedure:

1. Form students into groups of six students – two to hold one rope, two to hold the other rope, one to verify that the lines are parallel or perpendicular, and one to record the group’s action.
2. Ask students to use two or more skipping ropes to demonstrate a variety of parallel lines and provide evidence to verify that the lines are parallel. Evidence may include sliding an object between the ropes to demonstrate the ropes are the same distance apart at each point along the ropes, or measuring the distance between the ropes at several intervals.
3. Once students have perfected making parallel lines in several positions, repeat the process. This time, have them demonstrate a variety of perpendicular lines and provide evidence that the lines are perpendicular. As evidence, they may place a right-angle object, such as a book, at the intersection of the lines, or they may form the lines against an object with right angles, such as the side and front edges of a desk or a table.
4. Challenge students to find the middle of a line, prove it is the middle, and record their demonstration in their math journals or notebooks.
5. Have students demonstrate an angle, using their ropes. Ask them to add another line that would divide the line in half and create two equal angles. Challenge them to verify that the angles are equal, and have them record the process.
6. When the groups have completed the demonstrations, provided evidence, and recorded their work, distribute copies of BLM 7.SS.3.1: Parallel and Perpendicular Lines (Assessing Prior Knowledge), and have students complete the tasks individually.

Variations:

- Play a version of Simon Says, as outlined in the Assessing Prior Knowledge learning experience suggested for learning outcome 7.SS.2.
- Ask students to create a simple drawing composed of a certain number of parallel and perpendicular lines and write directions for each line formed. When directions are complete, have students join a partner, and either exchange direction sheets or give oral directions to make the composition. When the drawings are finished, students compare them to the original drawings and analyze any discrepancies. Alternatively, give directions to the whole class, and compare the products with a projection of the original drawing. Compare students' drawings to the original and discuss any differences.

Observation Checklist

- Listen to and observe students' responses to determine whether students can do the following:
 - Identify parallel lines.
 - Identify perpendicular lines by using a square corner.
 - Draw and name angles, lines, rays, and line segments.
 - Find the middle of a line.
 - Divide an angle in half.

Suggestions for Instruction

- **Describe examples of parallel line segments, perpendicular line segments, perpendicular bisectors, and angle bisectors in the environment.**

Materials:

- magazines
- poster paper
- electronic or other display medium
- Internet access (optional)
- cameras (optional)
- projector (optional)

Organization: Whole class, pairs or individuals

Procedure:

1. Introduce the class to the term *bisector*. Verify students' understanding of the term by asking them to identify or illustrate examples of perpendicular lines that bisect another line, or lines that bisect an angle.
2. Tell students they will participate in a treasure hunt to find examples of parallel line segments, perpendicular line segments, perpendicular bisectors, and angle bisectors. They can work individually or in pairs.
3. Together with students, set criteria for the number of each line to find. Places to search could include the classroom, lockers or desks, the hallways, the gymnasium, the playground, and other areas of the school. Alternatively, have students search magazines or the Internet for examples. (Examples may consist of musical instruments, such as keyboards and string instruments, the fulcrum on a balance scale, window frames, door frames, the separation in a double door, hallways, sidewalk cracks, brick patterns, goalposts, court markings in the gymnasium or outdoors, lanes in a swimming pool, streets or paths, the path of tires or skis, mitred corners on a box, logos and emblems, the alphabet.)
4. After the search criteria are established, have students undertake their treasure hunt. They can record their findings as sketches and labels, or take photographs.
5. They may wish to continue their search for homework.
6. When students have collected a sufficient number of treasures, have them organize their examples according to the type of lines represented, and choose a format for presenting their findings. They may choose a collage, a poster, a large classroom display, or an electronic display or slide show.
7. Arrange for students to share their findings with each other.

Variations:

- Using a projector, show examples of the different lines in various contexts. Ask students to identify and describe the various lines they see in the examples.
- Play a version of I Spy, asking students to identify parallel line segments, perpendicular line segments, perpendicular bisectors, and angle bisectors in the classroom or in another environment.



Observation Checklist

- Listen to and observe students' responses to determine whether students can do the following:
 - Describe examples of parallel line segments, perpendicular line segments, perpendicular bisectors, and angle bisectors in the environment.

Suggestions for Instruction

- **Identify line segments on a diagram that are parallel or perpendicular.**

Materials:

- schematic diagrams in books, blueprints, or drawings
- rulers
- grid paper
- tracing paper (optional)
- highlighters or pencil crayons of different colours (optional)
- computer drawing program (optional)
- number cubes (optional)
- photographs with examples of parallel or perpendicular lines (optional)

Organization: Whole class, individual

Procedure:

1. Introduce students to schematic diagrams through books, blueprints, or drawings.
2. Introduce them to the symbols that indicate parallel and perpendicular lines.
3. Have students create a schematic diagram showing the interior structure of a wood-framed building. Ask them to include top plates, bottom plates, window and door frames, and headers. Have them mark arrows and square corners on their diagrams to indicate the parallel and perpendicular line segments.
4. Have students make some general statements, at the bottom of their diagrams, regarding perpendicular and parallel line segments that appear in their diagrams.

Variations:

- Instead of creating a schematic diagram of a wood-framed building, students could diagram the shell of a bus, plane, ship, sport court, sewing pattern, road map, or airport runway.
- Have students create artwork composed of coloured lines and angles (perhaps similar to the work of Piet Mondrian) and labelled points. Ask them to create a key to go with their artwork that lists the parallel and perpendicular lines. The pictures and keys can be posted for display.
- Before indicating the parallel and perpendicular line segments in the diagrams described above, students could exchange diagrams with their partners, who would mark indicator lines on their drawings, and then return them to the creators to verify, discussing any discrepancies.
- Have students build an origami figure or shape, unfold it, trace the lines, and indicate parallel and perpendicular lines in the fold lines.

- Have students use a computer drawing program to create diagrams of interconnected lines. They can identify the parallel and perpendicular lines on their own diagrams, and exchange work with partners.
- Students could use their diagrams (or a supplied diagram) to play a game with a partner. Students each choose a different colour of highlighter or light-coloured pencil crayon. They pick either odd or even numbers on a number cube to represent parallel or perpendicular lines. Students take turns shaking the number cube and marking either a set of parallel lines or a set of perpendicular lines with their selected colour. If students cannot find a set of lines, they forfeit their turn. The player with the greatest number of sets of lines wins.
- Provide students with photographs on which they can mark the parallel or perpendicular lines represented, or have them create a schematic diagram using symbols to indicate the parallel and perpendicular line segments.
- Have students identify parallel and perpendicular lines in capital letters of the alphabet.



Observation Checklist

- Listen to and observe students' responses to determine whether students can do the following:
 - Identify parallel or perpendicular line segments on a diagram.

Suggestions for Instruction

- **Draw a line segment perpendicular to another line segment, and explain why they are perpendicular.**

Materials:

- records from Assessing Prior Knowledge learning activity (optional)
- math journals or notebooks
- geometry sets with straightedges or rulers, right triangles, protractors, and compasses
- Miras
- tracing paper
- pens or markers of different colours
- spinners or number cubes (optional)
- BLM 7.SS.3.2: Creating Perpendicular Lines (optional)

Organization: Whole class, small groups, individual

Procedure:

1. Ask students to share the methods they used in the Assessing Prior Knowledge learning activity to create perpendicular lines. Students will likely have used square corners, some may have used protractors to measure 90° angles, and some may have carefully folded paper and used the folds as guidelines for perpendicular lines.
2. Challenge students, working in groups, to think of multiple methods that could be used to draw perpendicular lines. Encourage students to use the tools in their geometry kits, Miras, and tracing paper. Have each student use his or her math journal or notebook to record the different methods their group thinks of. For each method, students draw an example and explain their thinking. Encourage students to make geometric drawings carefully, labelling points and indicating perpendicular lines with a square insert in the corner. Have students include comments (e.g., "I know $\overline{AB} \perp \overline{CD}$ because The reason this method works is because Suggestions for avoiding errors when using this method are Situations for which this method is recommended include").
3. When students have had sufficient time for their group work, reassemble as a class and have students share their ideas and explanations regarding the methods that could be used to draw perpendicular lines. Have students add any new ideas to their math journal entries, using another colour to highlight new learning.
4. Encourage students to think critically about and comment on the ideas that are shared in class. They may acknowledge ideas they agree with, express appreciation for the way ideas are explained, ask "how" or "why" questions, or offer further suggestions or support for an idea. If the class has not addressed a specific method when the sharing is finished, provide some guiding questions or hints, and send students back to work to develop another idea.

Methods of drawing perpendicular lines may include the following:

- a) Use a square corner. Draw a line segment using a straightedge. Place the right-angle triangle with one side of the right-angle corner lined up with the line segment. Trace a vertical line segment along the adjoining side of the triangle. The line segment is perpendicular because both line segments intersect at 90° angles, or form a square corner. Following the same principle, artists and designers use T-squares to make perpendicular line segments. Carpenters use carpenter squares to do the same thing.
- b) Use a protractor. Draw a line segment using a straightedge. Mark a point on the line segment. Align the point and the base line segment with the cross lines on the protractor. Mark the 90° measure. Use a straightedge to connect the original point and the 90° mark. The resulting line segment is perpendicular because the angle between the two line segments is 90° .

- c) Use a straightedge and a compass. Draw a line segment using a straightedge. Mark any two points along the line segment.

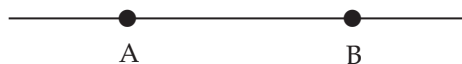

Use the compass to draw a circle around one of the points that has a radius greater than half the distance between the points. That radius is necessary for the circles to intersect.

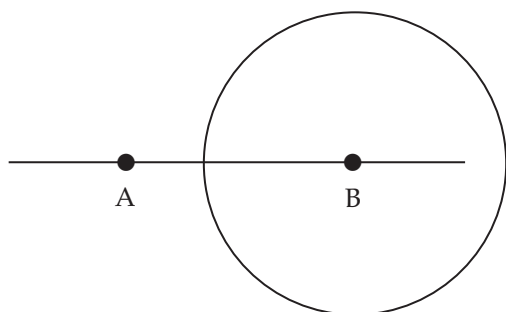

Ensuring that the radius is large enough to have the two circles intersect, draw a circle around the second point.

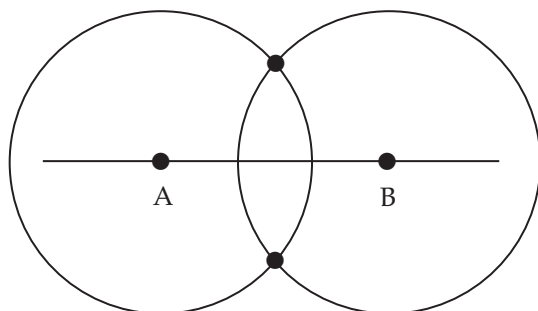

Note:

When constructing the perpendicular bisector, it is necessary for the radii of the two circles to be the same.

The circles will intersect at two points. Use a straightedge to connect those two points. The angle between the original line segment and the resulting line segment measures 90° ; therefore, the line segments are perpendicular to each other.

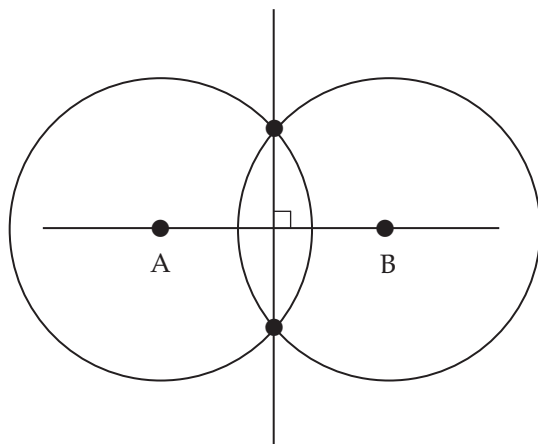

Note: With this method, it is not necessary to draw the entire circle; only an arc needs to be drawn. However, the circle emphasizes that the points joined to form the perpendicular line segments are radii of congruent circles, and, therefore, are the same length. Introduce students to the use of this method in art and medieval architecture, and how it can be used to determine large-scale perpendicular lines outdoors or in the sky.

- d) Use a Mira. Use a straightedge to draw a line segment. Lay the Mira across the line segment and adjust its position until the reflection of the line segment in the Mira lines up on top of the line segment itself. Trace a line segment along the edge of the Mira. That line segment is perpendicular to the original line segment because the angles at the intersection of the line segments are right angles.
 - e) Use tracing paper. Use a straightedge to draw a line segment. Carefully fold the paper across the line segment so that the portion of the line on the top paper lies on top of the line segment under the folded paper. When the line segments are aligned, crease the fold in the paper. Open it up and use a straightedge to trace the line segment along the crease. The line segments are perpendicular because the angle formed at the intersection measures 90° .
5. Have students practise drawing line segments using each of the methods. Then ask them to make a math journal entry commenting on which method they prefer, which method they believe to be most accurate, and which applications each method is best suited for.

Variations:

- Provide students with directions to produce specific line segments using specific methods. For example, draw line segment YZ 6 cm long. Use a straightedge and a protractor to draw a perpendicular line segment that crosses YZ at point X , 4 cm away from Y .
- Create a spinner identifying the five different methods for drawing perpendicular lines, or assign the numbers on a number cube to the five different methods, with the sixth number representing a missed turn. Students take turns spinning or rolling, and then drawing perpendicular line segments using the designated method. The first person to draw perpendicular line segments successfully using all five methods wins. Students can use BLM 7.SS.3.2: Creating Perpendicular Lines to record progress.



Observation Checklist

- Listen to and observe students' responses to determine whether students can do the following:
 - Draw a line segment perpendicular to another line segment, and explain why they are perpendicular.

Suggestions for Instruction

- **Draw the perpendicular bisector of a line segment using more than one method, and verify the construction.**

Materials:

- math journals or notebooks
- geometry sets with straightedges or rulers, right triangles, protractors, and compasses
- tracing paper
- Miras
- Number cubes or spinners (optional)
- BLM 7.SS.3.3: Creating Perpendicular Bisectors (optional)

Organization: Small groups, whole class, individual or pairs

Procedure:

Be prepared to be flexible regarding the time required for this learning experience. Ensure students have ample opportunity to explore and develop their understanding of different methods of drawing perpendicular bisectors before beginning the presentations.

1. Ask students to define *perpendicular bisector* and to explain how a perpendicular bisector differs from a perpendicular line segment.
2. Discuss why and when people may use a perpendicular bisector. For example, a perpendicular bisector may be used to find the best place to put a single support under a beam, to find the division in a drawing, a design, or a building from which to build formal symmetry, to divide a piece of property into equal portions, to find a line that is the same distance from two points. The last application may be important in a variety of contexts, ranging from planning a city or a meeting spot to setting up a lemonade stand.
3. Remind students that in the previous learning experience, they worked with five different methods to draw perpendicular lines. Ask students to work in groups to review those methods and to determine whether or not each method could be used as is, or with some modification, to draw a perpendicular bisector. As in the previous learning experience, have students provide proof that the perpendicular bisectors are perpendicular and bisect the line segment. They should also consider hints to ensure success in using a given method, ideas on how changing the technique affects the outcome, and explanations for why a method works.
4. Have each student make a math journal entry discussing the methods for creating perpendicular bisectors, including explanations and pointers regarding techniques and applications.

5. When students have had sufficient time for their group exploration, reassemble as a class and call upon different groups to present their modifications for one of the methods to draw a perpendicular bisector. Discuss their presentations.
6. Encourage students to think critically about and comment on the ideas that are shared in class. They may acknowledge ideas they agree with, express appreciation for ideas that are explained, ask “how” or “why” questions, or offer further suggestions or support for an idea. If the class has not addressed a specific method when the sharing is finished, provide some guiding questions or hints, and send them back to work to develop another idea.

The methods used for drawing perpendicular lines could also be used for drawing perpendicular bisectors, but with the following modifications:

- a) Use a square corner.

Modification: Before beginning, find the midpoint of the line. Include ideas on how to find the midpoint. Place the right angle at the midpoint.

- b) Use a protractor.

Modification: Once again, find the midpoint of the line and measure the 90° angle from the midpoint.

- c) Use a straightedge and a compass.

Modification: When drawing the circle, use the endpoints of the line segment as the centres for the circles. Connect the intersections of the circles to create the perpendicular bisector.

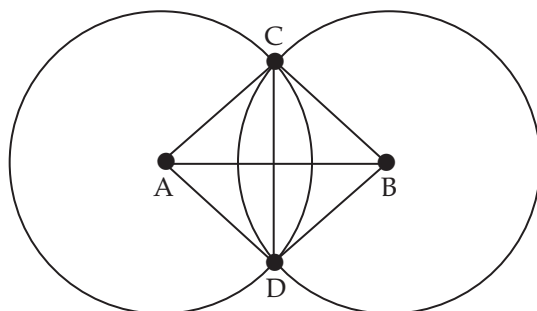

- d) Use a Mira.

Modification: When adjusting the Mira across the line segment, adjust it so the reflection of one endpoint of the line segment in the Mira lines up on top of the other endpoint of the line segment. Include hints for using the Mira successfully.

- e) Use tracing paper.

Modification: When folding the paper across the line, fold it carefully to ensure the half of the line on the top paper lies on top of the line under it, and that the endpoints of the line segment lie exactly on top of each other.

- f) Use a ruler to create a rhombus. Creating a rhombus around the line segment will create the perpendicular bisector of the segment because the diagonals of a rhombus are perpendicular bisectors of each other.
- Lay a straightedge at an angle across the line segment. Adjust the angle of the straightedge until each endpoint just touches the straightedge. The endpoints will be on opposite sides of the straightedge. Trace a line along both the top and the bottom of the straightedge.

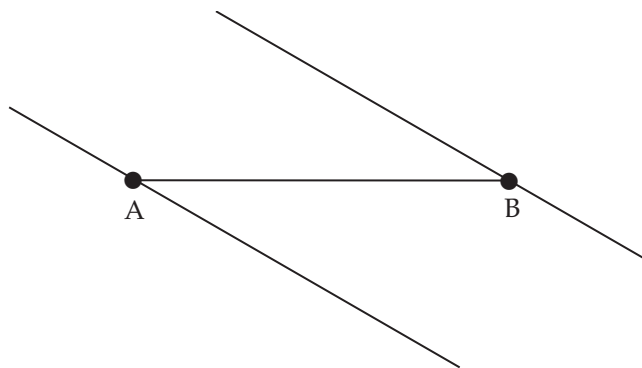

Note: For this method to work, the width of the straightedge needs to be less than the length of the line segment.

- Rotate the straightedge one-quarter turn until the end that was above the line is now below the line, and the end of the straightedge that was below is now above. Once again, adjust the straightedge so one point is above it and one point is below it, and trace both edges of the straightedge.

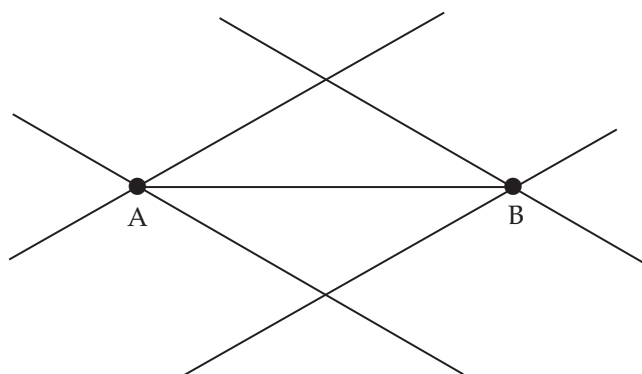

- Remove the straightedge. The intersecting lines create the vertices of the perpendicular bisector.

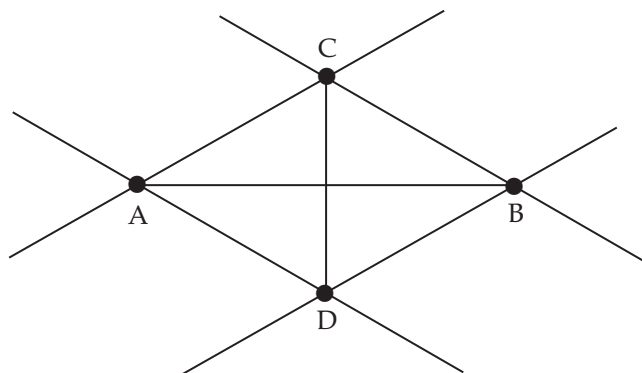

7. Have students practise using each of the six methods to create perpendicular bisectors. Individuals can create their own line segments or create line segments for their partners, or the teacher can assign line segments. After students have had sufficient practice in using the methods, ask them to make a math journal entry commenting on their preferred method, the method they think is most useful or most accurate, applications for the different methods, and so on.

Variations:

- Play a game in which students practise drawing perpendicular line segments. Students roll two number cubes to determine the length of a line segment. They spin a spinner, or roll a number cube, to determine the method to use to draw the bisector. They draw the perpendicular bisector or the line segment, and then verify that their drawing is correct by checking that the angles created measure 90° and that the line segments on either side of the bisector are equal in length. Partners work independently to be the first to create a bisector using all six methods. They can use BLM 7.SS.3.3: Creating Perpendicular Bisectors to record their progress.
- Investigate drawing perpendicular bisectors for each side of a triangle. Draw a circle using the point of intersection of the perpendicular bisectors as the centre of the circle and the radius as the distance from the centre to one of the vertices of the triangle. Continue this investigation for a variety of triangles, parallelograms, or other polygons.



Observation Checklist

- Listen to and observe students' responses to determine whether students can do the following:
 - Draw the perpendicular bisector of a line segment using more than one method, and verify the construction.

Suggestions for Instruction

- **Draw a line segment parallel to another line segment, and explain why they are parallel.**

Materials:

- math journals or notebooks
- geometry sets with straightedges or rulers, right triangles, protractors, and compasses
- tracing paper
- Miras
- straws, cardboard strips, stir sticks
- push-pins

Organization: Whole class, small groups

Procedure:

1. Ask students to recall the Assessing Prior Knowledge learning activity in which they created parallel lines using ropes. Review what parallel lines are and how to test whether a set of lines are parallel. Effective testing methods include the following:
 - Reflect lines in a Mira. If the Mira is placed perpendicular to parallel lines, both the lines will reflect on themselves.
 - Fold paper. If the paper is folded along a line perpendicular to the line segments, the folded lines will lie on top of each other.
 - Identify perpendicular lines between the two parallel lines, and measure to verify that the lines are the same distance apart.
2. Ask groups of students to identify as many methods as they can for creating parallel line segments. Have them test each of their methods to verify that the line segments created are parallel. Have students use their math journals to record the methods that work. If students need a hint, ask them whether lines that are perpendicular to the same line are parallel to each other.
3. Reassemble as a class, and have students share the methods they found. Discuss the advantages of each method and under what circumstances each method may be best to use. Have students add any new methods to their math journals.

Methods for creating parallel line segments may include the following:

- a) Trace both edges of a straightedge, such as a ruler.

- b) Diagonals of a rectangle are the same length and they bisect each other. If the diagonals are connected in the centre to form an X, all four arms of the X are equal to each other. Use two straws (or cardboard strips, stir sticks, and so on) to represent the diagonals, mark the midpoint of each, and connect them with a push-pin. Lay the X on a paper and connect two endpoints of adjacent arms with a straightedge. Trace a line segment. Mark the endpoints of the two remaining arms of the X and connect the points with a straightedge. The result is two parallel line segments. Stretch or collapse the X to adjust the distance between the parallel line segments.
- c) Use a right-angle triangle, or some other square corner, to draw a line segment. Place a straightedge along the line. Set the base of the right angle on the straightedge, and trace the side. This creates a line segment perpendicular to the original line segment. Slide the right angle along the straightedge to any desired position, and trace the side of the right angle. All the line segments perpendicular to the original line segment are parallel to one another.
- d) Connect points that are 90° and equidistant from the line segment. Use a right triangle or a protractor to draw two lines that are perpendicular to the original line segment. Measure and mark the same distance up each perpendicular line. Connect the marks to create a line segment parallel to the original line segment. The perpendicular lines are also parallel.
- e) Use the edge of a Mira to draw a line segment. Then use the Mira to draw perpendicular lines, whose reflections are in line with the original line segment. The lines perpendicular to the original line segment are all parallel to each other.
- f) Fold a piece of paper carefully with the corners matching. Fold the paper again in the same direction. Crease the folds well. Open the paper and, using a straightedge, trace line segments along the creases. The resulting line segments are parallel.
- g) Use a compass and a straightedge.
- h) Draw a line segment \overline{AB} .

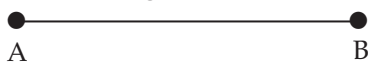

- Use a compass to draw a circle around point A and a circle around point B with the same radius.

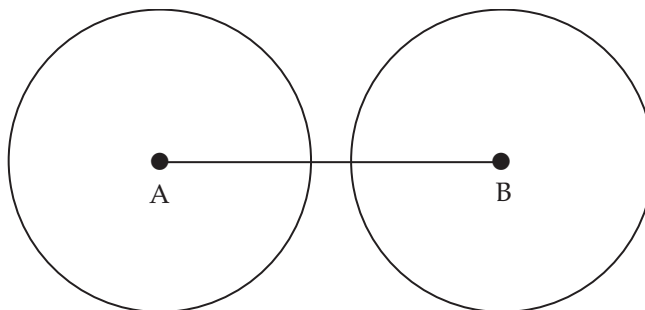

- Mark the highest (or lowest) points of each circle and connect them with a line. This line will be parallel to the original line segment \overline{AB} .

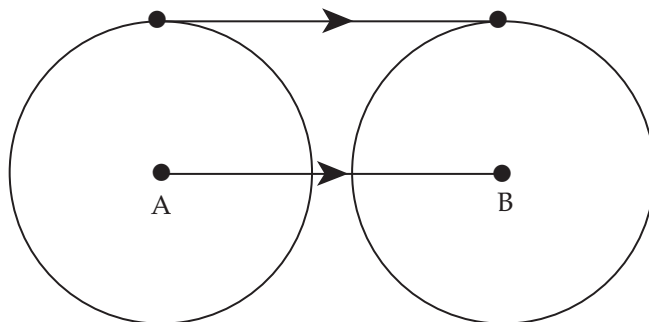

4. Have students practise drawing parallel line segments of different lengths and different distances apart. Partners, teachers, or the toss of a number cube can determine the length or distance, or students can choose their own measurements. After trying several methods to draw designated parallel line segments, students can choose the method they prefer and write about it in their math journals.

Variations:

- Create optical illusions by generating a set of parallel line segments, and then decorating each line with different colours or markings at different angles or lengths or thicknesses. Alternatively, divide the space between the parallel line segments with perpendicular lines of various widths and colours. Create a display of the illusions with a title (e.g., Find the Parallel Lines).



Observation Checklist

- Listen to and observe students' responses to determine whether students can do the following:
 - Draw a line segment parallel to another line segment, and explain why they are parallel.

Suggestions for Instruction

- **Draw the bisector of an angle using more than one method, and verify that the resulting angles are equal.**

Materials:

- math journals or notebooks
- geometry sets with straightedges, protractors, and compasses
- Miras
- tracing paper
- geometry software (optional)

Organization: Small groups, pairs or individual, whole class

Procedure:

1. Ask students to explain what an angle bisector is, and how they could test to see whether or not a line actually bisects an angle.
2. Have small groups work together to devise multiple ways of generating angle bisectors for a particular angle, and prove that the method generates a true bisector. Ask students to enter successful methods in their math journals.
3. Reassemble as a class to share students' methods and discuss the benefits and applications or use of the suggested methods. Have students make additional notes in their math journals as needed.

Methods for generating angle bisectors may include the following:

- a) Use a protractor to measure the original angle.
 - Divide the measurement in half.
 - Use the protractor to mark the new measure, and draw the bisector.
- b) Use tracing paper.
 - Copy the angle onto tracing paper.
 - Fold the paper so that the two original rays lie on top of each other.
 - Crease the paper along the fold.
 - Open the paper and use a straightedge to trace the crease.
- c) Use a Mira.
 - Place the Mira so that part of the length lies over the vertex of the angle.
 - Adjust the angle of the Mira until each of the angle rays are reflected on top of each other.
 - Trace the edge of the Mira.

d) Use a ruler.

- Line up the edge of the ruler along one of the rays in the angle so that the ruler lies “inside” the angle.

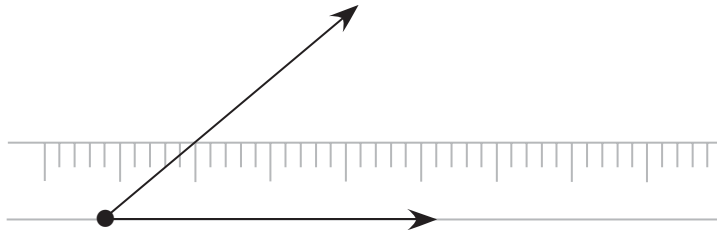

- Trace the side of the ruler not on the ray.

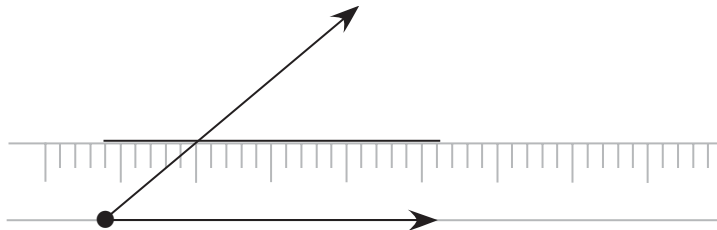

- Trace the side of the ruler for the other ray.

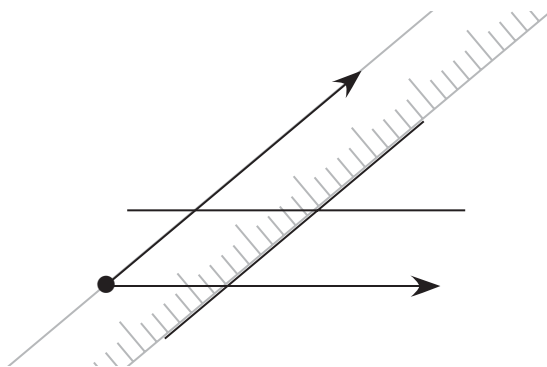

- Connect the vertex of the angle with the intersection of the lines just drawn.

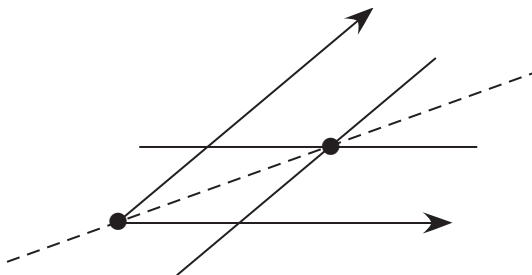

e) Use a compass and a straightedge.

- Place the compass point on the vertex of the angle and draw an arc across the two rays.

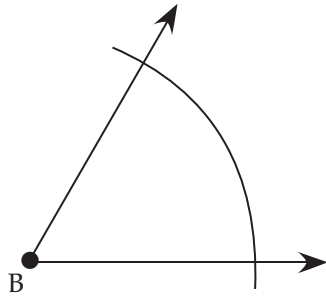

- Place the compass point on one of the intersecting points, and draw a circle or an arc around the centre area of the angle. Keep the same radius setting, and draw a circle around the other point where the arc intersects the other ray. It is not necessary to draw the entire circles, just the intersection of the arcs of the circle approximately where the bisector will be.

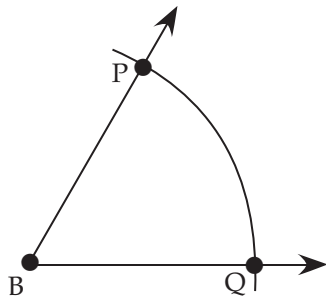

- Use the straightedge to connect the intersection of the two circles with the vertex of the ray.

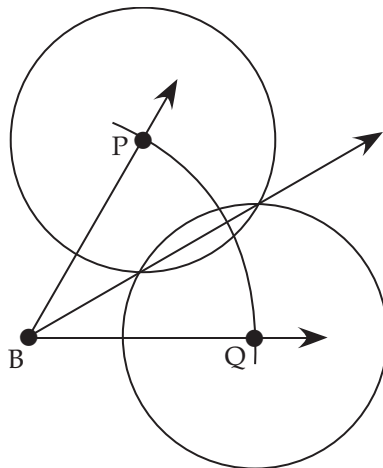

The arc across the rays creates two points equidistant from the vertex. Connect the two points with a straight line. Intersecting two circles with centre points on each of the ray points creates the perpendicular bisector of the line connecting them.

4. Have students practise drawing angle bisectors. Supply students with angles or angle measures for which students can create bisectors, or have students generate their own measures. Ask students to identify and justify a preferred technique for bisecting angles and write about it in their math journals.

Variations:

- Provide students with a handout outlining and illustrating the methods for creating an angle bisector, along with a compass and templates for those students who may need them.
- Have students create the angle bisectors of various triangles, and compare the results. Have them draw circles with the centre at the intersection of the angle bisectors, and the radii just touching one side of the triangle. Ask students to investigate what happens when they bisect the angles of parallelograms and other polygons.
- Have students use geometry software to practise and investigate angle bisectors of different shapes.



Observation Checklist

- Listen to and observe students' responses to determine whether students can do the following:
 - Draw the bisector of an angle using more than one method, and verify that the resulting angles are equal.
 - Draw a line segment perpendicular to another line segment, and explain why they are perpendicular.
 - Draw a line segment parallel to another line segment, and explain why they are parallel.
 - Draw the bisector of an angle using more than one method, and verify that the resulting angles are equal.
 - Draw the perpendicular bisector of a line segment using more than one method, and verify the construction.

PUTTING THE PIECES TOGETHER

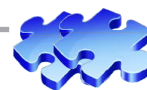

Maps, Floor Plans, or Design Projects

Introduction:

Students use geometric constructions to replicate a floor plan, create a map, or design a project.

Purpose:

In this investigation, students will demonstrate the ability to do the following (learning outcome connections are identified in parentheses):

- Construct circles and solve problems involving radius, diameter, and circumference of circles. (7.SS.1)
- Perform geometric constructions, including perpendicular and parallel line segments and bisectors. (7.SS.3)

Students will also demonstrate the following mathematical processes:

- Communication
- Connections
- Problem Solving
- Reasoning

Materials/Resources:

- geometry kits containing protractors, rulers, compasses, right triangles
- Miras
- tracing paper
- individual project supplies

Organization: Individual, whole class

Procedure:

Student Directions

1. Select a project, such as the following:
 - a) Replicate the floor plan for a sport facility (e.g., court, field, rink).
 - b) Design a map for a community, a fairground, a school campus, or a campground. Design major services to be equidistant from strategic points in the area.
 - c) Create a design for a fence, lattice, fabric pattern, or piece of artwork.

2. As a class, set criteria for the following:
 - a) the type and number of lines that must be included in the project (e.g., circles or half circles, parallel lines, perpendicular lines, perpendicular and angle bisectors)
 - b) the equipment that may be used to create the lines
 - c) a scoring rubric based on the criteria identified in (a) and (b)
3. Use what you have learned about angles, parallel and perpendicular lines, and bisectors to create your project.
4. Prepare a report on the types of lines included in your project, how you created the lines, methods you used to overcome challenges you faced creating the lines, and points you are proud of.



Observation Checklist

- Listen to and observe students' responses to determine whether students can do the following:
 - Construct circles and solve problems involving radius, diameter, and circumference of circles.
 - Draw a line segment perpendicular to another line segment, and explain why they are perpendicular.
 - Draw a line segment parallel to another line segment, and explain why they are parallel.
 - Draw the bisector of an angle using more than one method, and verify that the resulting angles are equal.
 - Draw the perpendicular bisector of a line segment using more than one method, and verify the construction.

PUTTING THE PIECES TOGETHER

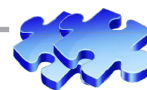

Design a Protractor

Introduction:

Students construct a protractor, using only a compass and a straightedge.

Purpose:

In this investigation, students will demonstrate the ability to do the following (learning outcome connections are identified in parentheses):

- Demonstrate an understanding of circles by determining the sum of the central angles. (7.SS.1)
- Perform geometric constructions, including perpendicular line segments, perpendicular bisectors, and angle bisectors. (7.SS.3)

Students will also demonstrate the following mathematical processes:

- Communication
- Connections
- Reasoning
- Technology
- Visualization

Materials/Resources:

- straightedge
- compass
- a long strip of paper, approximately 50 cm by 6 cm
- the Internet

Organization: Individual, small groups

Procedure:

Students fill in the grey areas of the following chart by reflecting on prior knowledge (from Grade 6) of sums of interior angles for polygons (6.SS.2), as well as by researching methods of polygon construction online.

Polygon Name	Number of Sides	Regular Polygon Sum of Interior Angles	Regular Polygon Interior Angles	Constructible?
Triangle	3	180°	60°	Yes
Quadrilateral (Square)	4	360°	90°	Yes
Pentagon	5	540°	108°	Yes
Hexagon	6	720°	120°	Yes
Heptagon	7	900°	900/7 or 128.57° . . .	No
Octagon	8	1080°	135°	Yes
Nonagon	9	1260°	140°	No
Decagon	10	1440°	144°	Yes
Hendecagon	11	1620°	147.27° . . .	No
Dodecagon	12	1800°	150°	Yes

Note: Some polygon names and numbers of sides could be removed for students to find, if desired.

Student Directions

1. On a sheet of paper, draw a line segment of any length, large enough to be the baseline of a protractor, or the diameter of a circular protractor.
2. Using a compass and geometric constructions, draw the perpendicular bisector of this line segment (see page 54 of Shape and Space). This will form a 90° angle and will also mark the centre of this newly constructed protractor. To construct a standard protractor, extend the bisector upward only. To construct a circular protractor, extend this bisector both upward and downward.
3. Using a compass, draw a semicircle (or full circle) using the intersection of your two line segments as the centre, and the endpoints of your line segments as the outside of the circle. Extend all line segments so that they extend to the circumference of this circle.
4. Label the horizontal line segment as 180° on the far left, and 0° on the far right. Label the top of the vertical line segment as 90°, and if you are constructing a circular protractor, label the bottom of this line segment as 270°.
4. Using geometric constructions only, bisect the 90° angle to find the 45° angle (see page 65 of Shape and Space). Repeat this process in each quadrant, labelling with the appropriate angles of 45° and 135° (as well as 225° and 315° for circular protractors).
5. Construct an equilateral triangle and cut it out (or create an equilateral triangle using the centre and endpoint of the semicircle or circle as one side). This will give a 60° angle. Trace or mark this angle onto the newly formed protractor, and repeat this process wherever possible on the protractor to add new benchmarks.

6. Bisect angles on this protractor to find and mark more benchmarks. If done carefully and accurately, students could find and mark measurements along the whole protractor for every 15° .

Extension:

Student Directions

1. Construct a pentagon by folding a long strip of paper. By tying a regular overhand knot (a shoelace knot) with the paper, and flattening carefully as you tighten, you will form a regular pentagon with equal sides and angles.

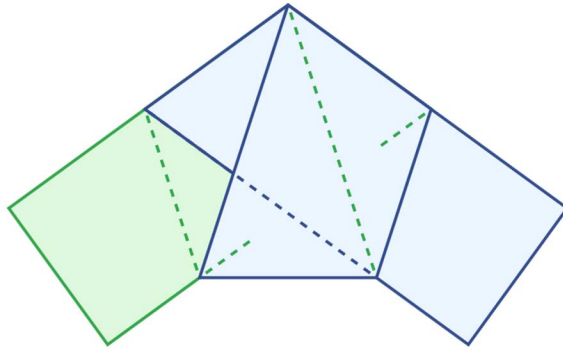

Source: "File:Overhand-folded-ribbon-pentagon.svg." *Wikipedia: The Free Encyclopedia*. Wikimedia Foundation, Inc. <https://commons.wikimedia.org/wiki/File:Overhand-folded-ribbon-pentagon.svg?uselang=en-ca> (26 May 2016). [Public domain], via Wikimedia Commons.

2. Referring to the chart on the previous page, use the measurement of the pentagon's interior angles of 108° , and the supplementary angle of 72° , to add more measurements. To label an angle of 72° , place a vertex of the pentagon on the centre of the protractor, and the base of the protractor along the horizontal line to the left of the centre. Continue rotating the pentagon on the centre of the protractor, using other existing benchmarks to add measurements.

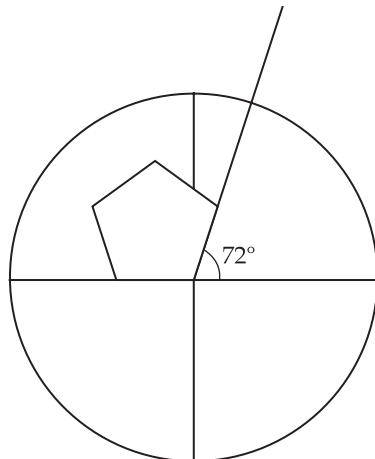

If this step is done carefully and accurately, students could find and mark measurements along the whole protractor for every 3° .

3. If you find you have missed any angles along the way, you can also use angle bisectors to find these missing measurements.

Further Extension:

1. Students research methods to construct other polygons, and find polygons that would allow for the completion of this learning activity to 1° of accuracy.

See the following websites:

Broderick, Shawn D. "Essay 2: Constructing Regular Polygons." *Jim Wilson, University of Georgia*. <http://jwilson.coe.uga.edu/EMAT6680Fa08/Broderick/essay2/essay2.html> (26 May 2016).

"How to Construct Regular Polygons Using a Circle." *wikiHow*. www.wikihow.com/Construct-Regular-Polygons-Using-a-Circle (26 May 2016).

"Nonagon." *Wikipedia: The Free Encyclopedia*. Wikimedia Foundation, Inc. <https://en.wikipedia.org/wiki/Nonagon> (26 May 2016).

2. Students research Gauss's proof that regular polygons can be constructed using a straightedge and compass.
3. Students can use the protractor to measure angles around the classroom, comparing their measurements with those of other students.

Shape and Space (Transformations) (7.SS.4)

Enduring Understanding(s):

The coordinate grid is used for plotting and locating points on a plane.

General Learning Outcome(s):

Describe and analyze the position and motion of objects and shapes.

SPECIFIC LEARNING OUTCOME(S):	ACHIEVEMENT INDICATORS:
7.SS.4 Identify and plot points in the four quadrants of a Cartesian plane using ordered pairs. [C, CN, V]	<ul style="list-style-type: none">→ Label the axes of a Cartesian plane and identify the origin.→ Identify the location of a point in any quadrant of a Cartesian plane using an ordered pair.→ Plot the point corresponding to an ordered pair on a Cartesian plane with units of 1, 2, 5, or 10 on its axes.→ Draw shapes and designs, using ordered pairs, on a Cartesian plane.→ Create shapes and designs on a Cartesian plane and identify the points used.

PRIOR KNOWLEDGE

Students may have had experience with the following:

- Representing and describing patterns and relationships using graphs and tables.
- Identifying and plotting points in the first quadrant of a Cartesian plane using whole-number ordered pairs.
- Performing and describing single transformations of a 2-D shape in the first quadrant of a Cartesian plane (limited to whole-number vertices).
- Creating, labelling, and interpreting line graphs to draw conclusions.
- Graphing collected data and analyzing the graph to solve problems.

For more information on prior knowledge, refer to the following resource:

Manitoba Education and Advanced Learning. *Glance Across the Grades: Kindergarten to Grade 9 Mathematics*. Winnipeg, MB: Manitoba Education and Advanced Learning, 2015. Available online at www.edu.gov.mb.ca/k12/cur/math/glance_k-9/index.html.

RELATED KNOWLEDGE

Students should be introduced to the following:

- Demonstrating an understanding of oral and written patterns and their corresponding relations.
- Constructing a table of values from a relation, graphing the table of values, and analyzing the graph to draw conclusions and solve problems.
- Modelling and solving problems that can be represented by one-step linear equations of the form $x + a = b$, concretely, pictorially, and symbolically, where a and b are integers.
- Modelling and solving problems that can be represented by linear equations of the form
 - $ax + b = c$
 - $ax = b$
 - $\frac{x}{a} = b, a \neq 0$concretely, pictorially, and symbolically, where $a, b,$ and c are whole numbers.
- Performing and describing transformations of a 2-D shape in all four quadrants of a Cartesian plane (limited to integral vertices).

BACKGROUND INFORMATION

In Grade 6, students graphed data, plotted points from ordered pairs, and drew shapes and designs in the first quadrant of a Cartesian plane. Experience with horizontal and vertical integral number lines in both Grades 6 and 7 prepared students to extend plotting skills to work in all four quadrants of a Cartesian plane. Plotting ordered pairs accurately is an important skill for performing and describing transformations in learning outcome 7.SS.5, and for graphing equations in Patterns and Relations.

The Cartesian Plane

René Descartes, a French mathematician, philosopher, physicist, and writer who lived in the first part of the seventeenth century, developed the Cartesian plane. The Cartesian coordinate system allows geometric shapes to be expressed in algebraic equations.

To teach about the Cartesian plane, start with a number line and extend it to the left to include negative integers. This representation is one-dimensional (1-D). To make it two-dimensional (2-D), take a second number line and make it perpendicular to the first, running it through 0, with positive numbers extending above the 0 and negative numbers below. You now have a Cartesian plane.

Patterns can be drawn on a Cartesian plane. Therefore, they can be also described by an algebraic equation. To help students conceptualize this concept, show them a pattern on some material (e.g., on a piece of cloth, wrapping paper, wallpaper), and tell them that this pattern can be described by an algebraic equation, and then plotted on a Cartesian plane. The equation of the selected pattern might be too complex for Grade 7, but it is an equation, nevertheless.

A practical application of this concept can be found in computer-aided design (CAD), where equations describing 2-D (as well as 3-D) Cartesian planes are entered into a computer. The computer then instructs a machine to draw, cut, or stitch lines or designs onto wood, metal, textiles, and so on. Among its many other uses, CAD is used for embroidery and interior design. For example, the Department of Textile Sciences at the University of Manitoba is equipped with a CAD laboratory.

In the future, people might go to special boutiques and enter body-scanning booths in order to take their measurements. They could later send their measurements to an online store, which would create custom-made clothing for them. The booths would use Cartesian planes to calculate the person's measurements.

You can integrate the Cartesian plane with the study of geography by using the coordinates on a map of the world. The equator could be represented as the x -axis, and 0° longitude could be represented as the y -axis. Using the map, ask students to determine the number of degrees (in relation to both the x -axis and the y -axis) between two cities. Coordinates can be determined with any type of map. You could, for example, use a highway map or a topological map of the area around your school or community.

Since Grade 7 students are often interested in expressing themselves, you could have them create their own flag or symbol on a Cartesian plane, including the coordinates, and have them explain how that shape represents them. Begin by showing them a flag with a simple design (e.g., Switzerland's flag), and ask them to determine its coordinates on a Cartesian plane.

Cartesian Plane

The Cartesian plane is formed by a horizontal axis and a vertical axis, labelled the x -axis and the y -axis respectively. It contains quadrants 1 to 4 (the quadrants are often labelled using Roman numerals I to IV).

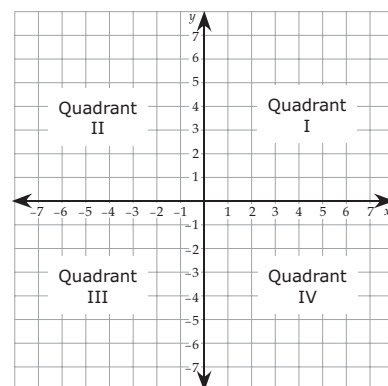

MATHEMATICAL LANGUAGE

axes
Cartesian plane
coordinates
ordered pair
origin
 x -axis
 y -axis

LEARNING EXPERIENCES



Assessing Prior Knowledge

Materials:

- grid paper
- magnetic surface and magnetic tape (optional)

Organization: Pairs

Procedure:

1. Review the concept of ordered pairs and how to plot coordinates in the first quadrant of a Cartesian plane by playing a version of Battleship, Private Detective, hide-and-seek, or whatever title seems appropriate.

Guidelines for the game follow:

- a) Divide the class into pairs for this game.
- b) Each player prepares two grids (about 10×10) by labelling the axes and numbering the grids according to the agreed-upon scale. Remind students to include the origin and to number the lines, but not the spaces. All the grids used in the same game must be identical.

- c) Each player secretly hides the predetermined number of items in one of his or her grids (e.g., vessels for Battleship, a crook and clues for Private Detective, a number of hiding people for hide-and-seek). Plot each item as either a vertical line or a horizontal line of three adjacent points.
- d) Students take turns naming ordered pairs in an attempt to uncover their partners' hidden items. As they name an ordered pair, they mark it on their own guessing grid, and the student who has hidden the objects marks the guessed point on the grid with the hidden items. If the guessing grid is visible to both students, they can limit errors in naming points. If the point that is named is part of an item, then the hider says, "hit," and the guesser receives another turn. When all points have been guessed, the identity of the object is revealed. The first player to uncover all the hidden objects is the winner.

Variation:

- Create a reusable display consisting of a coordinate grid on a magnetic surface, with magnetic tape on the back for use as hiding spots for various items (e.g., bushes, steps, shed, barrel, crate, tree, rock, car). Scatter the hiding spots at random intersections on the grid. In secret, hide the items behind hiding spots. Students take turns naming ordered pairs to find the hiding spots. The student who discovers the hiding spot wins a round. Play as a class, or allow small groups of students to take turns using the display.

Observation Checklist

- Listen to and observe students' responses to determine whether students can do the following:
 - Identify and plot points in the first quadrant of a Cartesian plane using whole-number ordered pairs.
 - Reason mathematically in order to guess strategically.

Suggestions for Instruction

- **Label the axes of a Cartesian plane and identify the origin.**
- **Identify the location of a point in any quadrant of a Cartesian plane using an ordered pair.**
- **Plot the point corresponding to an ordered pair on a Cartesian plane with units of 1, 2, 5, or 10 on its axes.**
- **Draw shapes and designs, using ordered pairs, on a Cartesian plane.**
- **Create shapes and designs on a Cartesian plane and identify the points used.**

Materials:

- grid paper
- lists of ordered pairs that, when plotted and connected together, form a simple shape or a picture in quadrant I (optional)

Organization: Individual, pairs or small groups

Procedure:

1. Have each student create a simple shape, such as a polygon, on quadrant I of a coordinate grid. The student then uses the plot to generate a list of ordered pairs.
2. Have students exchange lists with a partner, plot the points on the partner's list, and connect the points in the order given to create the polygon. Students verify each other's work.

Variations:

- Have one student share his or her list orally with a larger group or with the whole class. As the student reads the list, the other students plot and connect the points. When the list is complete, the reader shows what the finished product looks like, and the group or class discusses any discrepancies.
- Provide students with a handout of ordered pairs that create designs or pictures. Include a plot of a design or picture, and have students list the ordered pairs.



Observation Checklist

- Listen to and observe students' responses to determine whether students can do the following:
 - Identify and plot points in the first quadrant of a Cartesian plane using whole-number ordered pairs.

Suggestions for Instruction

- **Label the axes of a Cartesian plane and identify the origin.**
- **Identify the location of a point in any quadrant of a Cartesian plane using an ordered pair.**

Materials:

- demonstration board
- grid paper
- pencils and highlighters
- lists of ordered pairs that, when plotted and connected together, form a simple shape or a picture in quadrant I (optional)
- Neuschwander, Cindy. *Sir Cumference and the Viking Map: A Math Adventure*. Illus. Wayne Geehan. Watertown, MA: Charlesbridge Publishing Inc., 2012.

Organization: Whole class

Procedure:

1. Inform students they will create a math story. The story will require a main character who is able to move about freely (e.g., a dog in a field, a sightseeing tourist, a basketball player on a court, a ballerina on a stage, a taxi driver in New York city, a fly on the wall).
 - a) Ask students to begin planning the story by making a mark on a point near the centre of a grid paper. Ask them to imagine that the mark represents the main character, and the grid paper represents the area where the character moves about. Have students label the original mark with the letter O (for original mark).
 - b) Next, tell students to point their pencils to the O point and prepare to mark a trail on the grid as they follow their imaginary character on an adventure. Each time you call out a letter name, students form a point at the nearest intersection on the grid and label the point with the letter that was called.
 - c) As you call out the letters of the alphabet, students track the movements of the character. Wait about five seconds between letters. Stop around letter J, and have students go back and make their points and letters obvious by highlighting them.
 - d) Provide a sample copy of the trail on the demonstration board. Use either a student's copy or a copy that has been prepared ahead of time. The trail represents the path the character followed. The letters were written at regular intervals, so each point represents where the character was at a given time.
2. Tell students that a method is needed to describe the location of the character at any given time during the story. The location is to be given in relation to the starting point. Provide sufficient time for students to think, and perhaps talk with a partner, about a method.

- a) If students experience difficulty in their work, ask them to concentrate just on the first points, and describe where point A is in relation to point O. Responses may include descriptions such as these: to the left, to the right, above, or below.
 - b) If students do not quantify the direction, ask them to make the descriptions more specific by indicating how far above or below the starting point a given point is, or how far to the left or to the right.
 - c) If students do not think of number lines, ask whether there are reference marks they could add to the grid paper to make the descriptions easier, such as a line to delineate left and right, and a line to separate points above and below the initial position. Adding numbers to the line would indicate how far right, and how far above. Negative numbers would indicate how far left and how far below. This amounts to adding both a horizontal and a vertical number line through the starting point of O.
3. Tell students about the history of the Cartesian plane. René Descartes, who lived in France in the early 1600s, is credited as being the first person to think of coordinating two intersecting number lines. This type of grid is very important to mathematicians, and is named for its inventor. The name Descartes means “from Cartes,” so the adjective that describes his last name would be Cartesian, just as something from Canada is Canadian. The Cartesian plane mixes algebra and geometry and allows mathematicians to graph equations (which Grade 7 students do in the Patterns and Relations strand). The positions of the character in the story created in this learning activity could be described with an equation, although it may require a rather complicated equation to describe most of the patterns. There is a story that René Descartes thought of the Cartesian plane to describe the movements of a fly on the ceiling; however, this story is not verified.
 4. Explain the features of the Cartesian plane. The horizontal number line in the Cartesian number line is termed the x -axis, and the vertical number line the y -axis. The point found at $(0, 0)$ is called the *origin*. The scale is chosen based on the numbers in the situation. The four main areas are named *quadrants*. They are numbered 1 to 4 (often expressed as Roman numerals I to IV) in a counter-clockwise direction beginning with the positive coordinates with which we are most familiar.

Example:

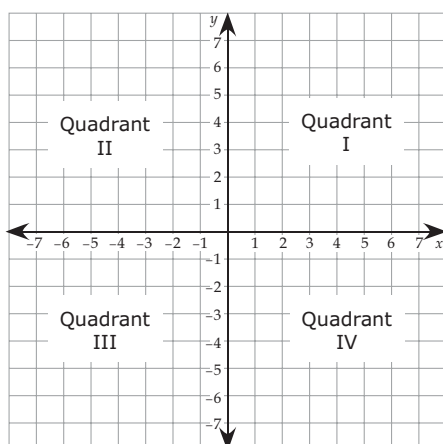

5. If students have not already done so, have them include the following on their own grid papers: add the horizontal and vertical number lines through the origin, label the x -axis and the y -axis, and label the quadrants.
6. Returning to the adventures of the character in the story, have students sort the points where the character was in each quadrant and make a list. Ask them to include the quadrant, the name of the point, and the ordered pair that describes each point.
7. To complete the story about the character's adventures (where the character went), have students turn the grid into a map. If students are interested in writing the story, perhaps the project can be integrated with English language arts.

Variations:

- Begin this learning activity by reading *Sir Cumference and the Viking Map* by Cindy Neuschwander, as an example of a story that uses coordinates to find a buried treasure.
- Provide scaffolding (e.g., pre-plotted grid paper, a pre-numbered grid, a list of questions to guide conclusions) for those requiring it.
- Eliminate the "math story" and the student-created points. Provide a piece of grid paper with one point labelled as origin (O), and 10 points labelled A to J. Explain the quadrant system, and have students add the axes, scale, and quadrants. Have them list the ordered pairs of the points in each quadrant.
- Photocopy any type of map and add a grid system that aligns with some significant points, including an origin and an x -axis and a y -axis. Distribute copies of the map to students, and have them trace the axes and add labels. Then have students use ordered pairs to describe the position of significant points in relation to the origin, or identify the location for a point of ordered pairs. The link between coordinate grids and mapping the Earth with lines of longitude and latitude provides an integration point for mathematics and social studies.

Sample Website:

The following online resource, written for children, provides some history on mapping the Earth with lines of longitude and latitude:

The Math Forum @ Drexel. "Ancient Greek Maps." *Chameleon Graphing*. 1994–2011.
<http://mathforum.org/cgraph/history/greekmaps.html>.



Observation Checklist

- Listen to and observe students' responses to determine whether students can do the following:
 - Label the axes of a Cartesian plane and identify the origin.
 - Identify the location of a point in any quadrant of a Cartesian plane using an ordered pair.

Suggestions for Instruction

- **Label the axes of a Cartesian plane and identify the origin.**
- **Identify the location of a point in any quadrant of a Cartesian plane using an ordered pair.**
- **Plot the point corresponding to an ordered pair on a Cartesian plane with units of 1, 2, 5, or 10 on its axes.**

Materials:

- Cartesian plane
- grid paper
- rulers
- stickers (optional)
- magnetic board and magnetic tape (optional)

Organization: Whole class (divided into two teams), small groups (of three students)

Procedure:

1. Review the features of the Cartesian plane and the ways in which the coordinate grid can be labelled with different scales, depending on the numbers being worked with.
2. Using a Cartesian plane, plot several points and label them with letter names. Ask students to name the ordered pair that identifies the location of a point for a particular letter, or ask students to name a letter in a quadrant, or the quadrant that matches a letter. Divide the class into two teams, and have students complete this exercise as a competitive game.
3. When students have demonstrated a level of competency, ask them to prepare a similar plot of eight letter points and a key that identifies the ordered pairs that represent the points of each letter. Inform students that the plot will be used for a group game, so they need to make it large enough to be seen and keep the key separate for quick reference.
4. Have students work in groups of three. One student takes the role of leader. The leader displays the plot students made, and asks the other group members questions related to reading the plot (e.g., What ordered pair names the location of X? What letter is at the point of a particular ordered pair?). The group must decide whether the leader will alternate questions between the contestants or whether the contestants will compete to be the first to answer. The round is over when the points have all been identified. At the end of the round, the winner becomes the next leader.

Variations:

- Students can play online games identifying points on a Cartesian plane. Two examples are available on the following websites:

FunBased Learning. "Medium Version of Graph Mole." *Graphing*. 2007.

<http://funbasedlearning.com/algebra/graphing/points2/>.

In this game, a mole pops up at random points and the player must select the ordered pair that identifies the spot. The game has three levels, each successive level requiring a faster response.

Math-Play.com. "The Coordinate Plane." *Coordinate Plane Game*.

www.math-play.com/Coordinate%20Plane%20Game/Coordinate%20Plane%20Game.html.

In this game, players match a point on a Cartesian plane with x - or y -coordinates, ordered pairs, or the quadrant in which the point is located.



Observation Checklist

- Listen to and observe students' responses to determine whether students can do the following:
 - Label the axes of a Cartesian plane and identify the origin.
 - Identify the location of a point in any quadrant of a Cartesian plane using an ordered pair.
 - Plot the point corresponding to an ordered pair on a Cartesian plane with units of 1, 2, 5, or 10 on its axes.

Suggestions for Instruction

- **Label the axes of a Cartesian plane and identify the origin.**
- **Identify the location of a point in any quadrant of a Cartesian plane using an ordered pair.**
- **Plot the point corresponding to an ordered pair on a Cartesian plane with units of 1, 2, 5, or 10 on its axes.**

Materials:

- Cartesian plane
- grid paper
- rulers

Organization: Small groups (of five students)

Procedure:

1. Students play a modified group version of the game Connect Four or Four in a Row. A group can consist of five students—one host and four participants.
2. Using grid paper (1 cm or larger), each student creates a game sheet consisting of a Cartesian plane with an x -axis and a y -axis, each having five negative and five positive divisions. Do not label the scale.
3. Each participant chooses an easy-to-draw symbol (e.g., #, ▲, ●, ✓), and the host chooses the scale to be used for the round and records it at the top of the game sheet.
4. The participants take turns naming an ordered pair that matches the scale, and the host writes that participant's symbol on the matching point the participant names. The participants practise identifying the ordered pairs, and the host practises plotting the points.
5. The participants try to get four of their symbols in a row. When they achieve this, they become the host.
6. Each participant will need to monitor that the host is plotting the ordered pairs correctly. If participants name a point already marked by a symbol, they lose their turn.

Variations:

- Increase the size of the grid and the number of symbols to align.
- Use stickers instead of drawing symbols. Or play on a magnetic board and have students affix magnetic tape to the back of their symbol pieces.
- Play the game in larger groups and have students cooperate to plan strategies.
- Hold a tournament.

**Observation Checklist**

- Listen to and observe students' responses to determine whether students can do the following:
 - Label the axes of a Cartesian plane and identify the origin.
 - Identify the location of a point in any quadrant of a Cartesian plane using an ordered pair.
 - Plot the point corresponding to an ordered pair on a Cartesian plane with units of 1, 2, 5, or 10 on its axes.

Suggestions for Instruction

- **Label the axes of a Cartesian plane and identify the origin.**
- **Identify the location of a point in any quadrant of a Cartesian plane using an ordered pair.**
- **Plot the point corresponding to an ordered pair on a Cartesian plane with units of 1, 2, 5, or 10 on its axes.**
- **Draw shapes and designs, using ordered pairs, on a Cartesian plane.**

Materials:

- BLM 7.SS.4.1: Plotting Points on a Cartesian Plane
- rulers

Organization: Whole class, individual, pairs

Procedure:

1. As a class, review the axes, origin, and quadrants of a Cartesian plane.
2. Distribute copies of BLM 7.SS.4.1: Plotting Points on a Cartesian Plane, and have students individually label the axes with the appropriate scales, plot the points, and identify the quadrants in which the figures are located.
3. Have students, working in pairs, exchange their completed plots with their partners. They compare plots and quadrants and discuss any discrepancies.

Variations:

- Have students choose a scale, and label the axes of a Cartesian plane accordingly. Next, they draw a simple shape, such as a polygon or some other figure, in any quadrant or combination of quadrants, and use the plot to generate a list of ordered pairs. Have students exchange lists with a partner, plot the points on the partner's list, and connect the points in the order given to create the figure. Students can verify each other's work.
- Provide students with designs plotted on a Cartesian plane, and ask them to create a list of the ordered pairs to create the design.



Observation Checklist

- Listen to and observe students' responses to determine whether students can do the following:
 - Label the axes of a Cartesian plane and identify the origin.
 - Identify the location of a point in any quadrant of a Cartesian plane using an ordered pair.
 - Plot the point corresponding to an ordered pair on a Cartesian plane with units of 1, 2, 5, or 10 on its axes.
 - Draw shapes and designs, using ordered pairs, on a Cartesian plane.

Suggestions for Instruction

- **Identify the location of a point in any quadrant of a Cartesian plane using an ordered pair.**

Materials:

- BLM 7.SS.4.2: Cartesian Plane Quadrant Cards
- scissors
- grid paper
- rulers
- blank card templates (optional)

Organization: Small groups (of two to four students)

Procedure:

1. Have students form small groups.
2. Distribute one set of card sheets to each group of students and have them cut the sheets to separate the cards. (See BLM 7.SS.4.2: Cartesian Plane Quadrant Cards.)
3. After giving students sufficient time to separate the cards, call the groups together, and review Cartesian planes, axes, origin, labelling scales, and quadrants.
4. Give the following directions to students:
 - a) Mix up the quadrant cards and put them in a stack.
 - b) Lay four ordered pair cards face up on the table.
 - c) The first player draws a quadrant card and matches it to the set of ordered pairs that would create a triangle in that quadrant or set of quadrants.

- d) If students agree the match is correct, the player keeps the set, and another ordered pair card is turned face up. If it is not a match, the quadrant card goes back in the deck. Some plotting on grid paper may be necessary to verify responses.
- e) Play continues to pass to the next player.
- f) The student who makes the most sets wins.

Variations:

- Students can create additional ordered pair cards that create other figures.
- Students or the teacher can create additional ordered pair cards. The cards can be used to play “make a set” card games fashioned after Go Fish!, Rummy, Pit, and so on.



Observation Checklist

- Listen to and observe students’ responses to determine whether students can do the following:
 - Identify the location of a point in any quadrant of a Cartesian plane using an ordered pair.
 - Use reasoning and visualization to help determine the placement of points.

Suggestions for Instruction

- **Label the axes of a Cartesian plane and identify the origin.**
- **Identify the location of a point in any quadrant of a Cartesian plane using an ordered pair.**
- **Plot the point corresponding to an ordered pair on a Cartesian plane with units of 1, 2, 5, or 10 on its axes.**
- **Draw shapes and designs, using ordered pairs, on a Cartesian plane.**
- **Create shapes and designs on a Cartesian plane and identify the points used.**

Materials:

- BLM 7.SS.4.3: Plot This Picture
- grid paper
- ruler
- pattern blocks (optional)

Organization: Individual

Procedure:

1. Provide students with grid paper and copies of BLM 7.SS.4.3: Plot This Picture, and ask them to plot and connect the specified points to create designs.
2. Ask students to create their own designs on grid paper and list the ordered pairs. If they need help, suggest using pattern blocks to build a design, and then tracing it onto grid paper.
3. Display students' creations.

Variation:

- Provide students with the finished plot and ask them to create a list of ordered pairs that match the picture.

Sample Website:

For a display of coordinate picture designs and a student gallery of completed pictures, refer to the following website:

Plotting Coordinates.com. *CoordinArt News*. 2008–2010.

www.plottingcoordinates.com/coordinartnews.html.

**Observation Checklist**

- Listen to and observe students' responses to determine whether students can do the following:
 - Label the axes of a Cartesian plane and identify the origin.
 - Identify the location of a point in any quadrant of a Cartesian plane using an ordered pair.
 - Plot the point corresponding to an ordered pair on a Cartesian plane with units of 1, 2, 5, or 10 on its axes.
 - Draw shapes and designs, using ordered pairs, on a Cartesian plane.
 - Create shapes and designs on a Cartesian plane and identify the points used.

Shape and Space (Transformations) (7.SS.5)

Enduring Understanding(s):

While geometric figures are constructed and transformed, their proportional attributes are maintained.

General Learning Outcome(s):

Describe and analyze the position and motion of objects and shapes.

SPECIFIC LEARNING OUTCOME(S):	ACHIEVEMENT INDICATORS:
7.SS.5 Perform and describe transformations of a 2-D shape in all four quadrants of a Cartesian plane (limited to integral vertices). [C, CN, PS, T, V]	(It is intended that the original shape and its image have vertices with integral coordinates.) → Identify the coordinates of the vertices of a 2-D shape on a Cartesian plane. → Describe the horizontal and vertical movement required to move from a given point to another point on a Cartesian plane. → Describe the positional change of the vertices of a 2-D shape to the corresponding vertices of its image as a result of a transformation or successive transformations on a Cartesian plane. → Perform a transformation or consecutive transformations on a 2-D shape, and identify the coordinates of the vertices of the image. → Describe the image resulting from the transformation of a 2-D shape on a Cartesian plane by comparing the coordinates of the vertices of the image.

PRIOR KNOWLEDGE

Students may have had experience with the following:

- Performing and identifying a single transformation (translation, rotation, or reflection) of a 2-D shape, and drawing and describing the image.
- Performing a combination of successive transformations of 2-D shapes to create a design, and identifying and describing the transformations in the first quadrant of a Cartesian plane (limited to whole-number vertices).

- Identifying and plotting points in the first quadrant of a Cartesian plane using whole-number ordered pairs.
- Graphing collected data and analyzing the graph to solve problems.

For more information on prior knowledge, refer to the following resource:

Manitoba Education and Advanced Learning. *Glance Across the Grades: Kindergarten to Grade 9 Mathematics*. Winnipeg, MB: Manitoba Education and Advanced Learning, 2015. Available online at www.edu.gov.mb.ca/k12/cur/math/glance_k-9/index.html.

RELATED KNOWLEDGE

Students should be introduced to the following:

- Performing geometric constructions, including
 - perpendicular line segments
 - parallel line segments
 - perpendicular bisectors
 - angle bisectors
- Identifying and plotting points in the four quadrants of a Cartesian plane using ordered pairs.

BACKGROUND INFORMATION

Transformations

Movement is ubiquitous in our world; even the Earth itself is in constant motion. Movements occur as changes in size, shape, or position. The area of mathematics that brings geometry and algebra together to describe these changes is the study of transformations.

The three transformations that Middle Years students study are translations, reflections, and rotations. Informally, these transformations are referred to as slides, flips, and turns, and each relates to changes in position and/or orientations in a 2-D plane. In previous grades, students performed and described single transformations of 2-D shapes. In Grade 7, they extend their skills to work with successive transformations in all four quadrants of the plane.

The learning experiences suggested for learning outcome 7.SS.5 will help students to develop their understanding and appreciation of the transformations existing around them, enhance their problem-solving skills and spatial sense, and prepare them for further studies in algebra and geometry.

Students regularly encounter 2-D transformations represented in design patterns and computer graphics. They are evident on logos, fabric patterns, frieze patterns, wallpaper, architectural design, landscape design, and so on. Transformations can be used to create interesting symmetrical patterns. In addition, 2-D transformations on Cartesian planes can be used to represent physical movements in a single plane (e.g., sports plays, rides at a fair, traffic routes). Movie animation is created using motion geometry.

Many designs are symmetrical transformations of a core. Examples can be viewed and created online.

Sample Websites:

For a range of samples of rotated shapes, refer to the following website:

Wolfram Demonstrations Projects. *Symbol Rotation Patterns*. Contributed by Danielle Nogle. Based on a program by Chris Carlson. 2011.
<http://demonstrations.wolfram.com/SymbolRotationPatterns/>.

The following website allows students to create designs with up to eight lines of symmetry:

MathIsFun. "Symmetry Artist." *Geometry*. 2011.
www.mathsisfun.com/geometry/symmetry-artist.html.

Transformations are studied using 2-D shapes, or pre-images, and their images. The shapes are named by their vertices (ABC) and the images are labelled (A'B'C'), read as A prime, B prime, C prime, and so on. Successive images are labelled with additional prime marks (A''B''C''), and so on.

Translations, Reflections, and Rotations

In translations, reflections, and rotations, the shapes and their images are congruent, but their orientation on the plane and/or their location on the plane may change, depending on the shape and the type of transformation.

- **Translations (slides):** Each point in the shape moves the same distance and the same direction to create the image. The orientation of the shape and its image remain the same; only the location on the plane changes. Demonstrate translations on a coordinate grid by copying the shape onto grid paper of the same size, cutting it out, and physically sliding the copy on the grid. Another method is to count the horizontal and vertical moves of each vertex. A slide arrow indicates the direction of a translation.

Note:

As students advance in grades, it is important for them to be familiar with and use mathematical language. Encourage students to use the terms *translation*, *reflection*, and *rotation*, rather than *slide*, *flip*, and *turn*.

Example:

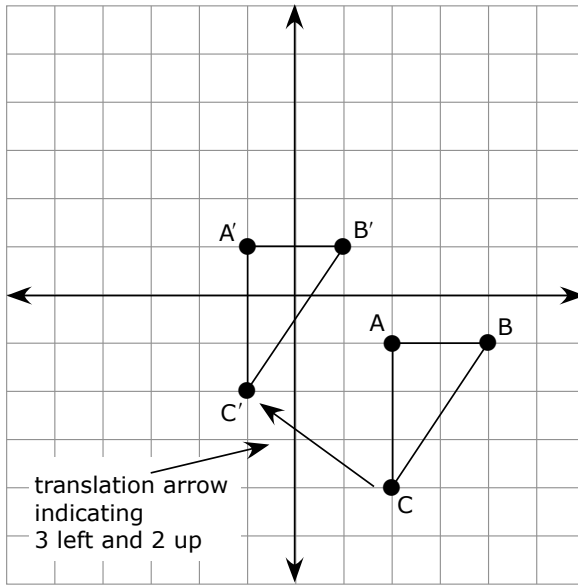

Translations are also commonly described using coordinate notation with square brackets (e.g., 3 left, 2 up is $[-3, 2]$).

- **Reflections (flips):** The points in the shape and the matching points in the image are equal distances from a line of reflection. The line of reflection may be inside or outside the shape. The orientation of the figure flips over the line of reflection to create a mirror image in a new location. Demonstrate reflections by physically flipping a copy of the shape over the line of reflection, by placing a Mira along the reflection line, or by counting the perpendicular distance of each point from the mirror line. The line of reflection is indicated by marking a mirror line on the grid.

Example:

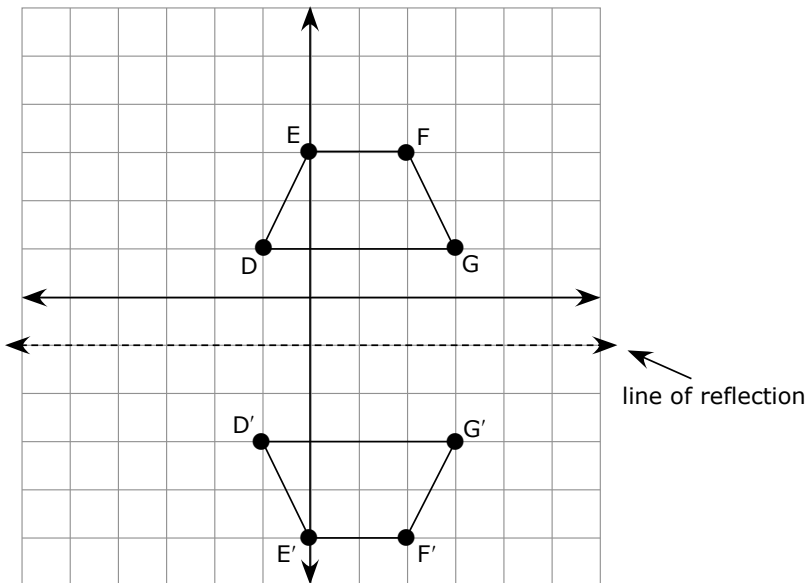

- Rotations (turns):** The points of the shape are rotated the same number of degrees or fraction of a turn clockwise (cw) or counter-clockwise (ccw) around a point termed the centre (or point) of rotation. The centre of rotation may be any point inside or outside the figure. The orientation of the image will depend on the direction and the angle of rotation. The change in location of the image varies greatly, depending on the location of the centre of rotation and the direction and angle of rotation. Demonstrate rotations by physically rotating the shape the specified number of degrees around the centre of rotation, or by tracing the shape and the centre of rotation onto tracing paper, and then matching the centre of rotation and physically rotating the tracing paper. Rotating the side of the shape rather than just one point may help reduce accidental sliding during the rotation. Another technique to locate a rotation requires the use of a protractor to measure the angle and a compass to copy the line length. Specify rotations with a curved arrow that indicates the direction of the rotation, and write the number of degrees or the fraction of a turn for the rotation. Rotations are commonly described using a degree measure and direction (e.g., 90° ccw).

Example:

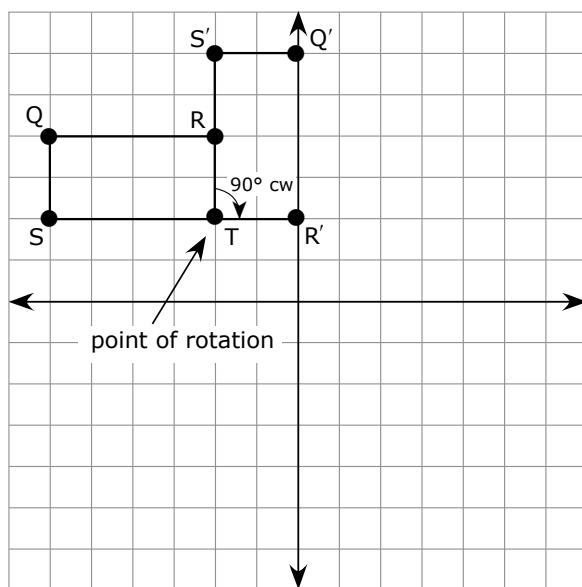

Transformational changes can be described by identifying the type of transformation, the changes in orientation or position of the vertices, the horizontal and vertical movement, or the new x - and y -coordinates of the vertices of the image, or by stating the change in x - and y -coordinates between the shape and its image.

MATHEMATICAL LANGUAGE

Cartesian plane
centre of rotation
clockwise
congruent
coordinates
counter-clockwise
image
line of reflection
quadrant
reflection
rotation
shape
transformation
translation
vertex
vertices

LEARNING EXPERIENCES



Assessing Prior Knowledge

Materials:

- large space (gymnasium or outdoors)
- one skipping rope (or another line) for each group
- math journals (optional)

Organization: Small groups (of six students), whole class

Procedure:

1. Form groups, with six students in each group.
2. Explain to students that they will be working together to demonstrate three types of transformations.

3. Review the concept that transformations are about moving and changing position.
 - a) The three types of transformations students will demonstrate are translations (slides), reflections (flips), and rotations (turns).
 - Remember to include a mirror line for the reflection and reflect the entire shape.
 - Rotations require a centre of rotation, a direction, and an angle of rotation (e.g., 90° , 180° , 270° clockwise or counter-clockwise).
 - Centres of rotation and mirror lines can be inside or outside the shape.
 - b) To show the pre-image and the resulting image, students can pair up as one point of the shape. To transform, they can divide, leaving one point (student) in the original location and one point (student) transformed to the new location. If this will confuse students, leave out this aspect and move the entire pre-image to the image.
4. Have group members work together to come up with a way to demonstrate the transformations using their bodies and a skipping rope. Later they will regroup to show their demonstration to their classmates and explain the transformation and its important features, including the pre-image, image orientation, and location.
5. As students are practising, circulate among them and provide hints and encouragement where needed.
6. Reassemble as a class and have students share their learning. Below are some ideas that may be included in the presentations:
 - a) Translations may include triangle or rectangle arrangements.
 - Directions are given to slide so many steps forward, backward, right, or left.
 - The image has changed location only.
 - The points are still facing the same direction.
 - The orientation remains the same.
 - The image is still the same size or congruent to the pre-image.

- b) Reflections may include students lying along a mirror line, and mirroring one another at any distance.
 - Each point and its partner are equal perpendicular distances to the mirror line.
 - The orientation of the pre-image has been flipped from the original.
- c) Rotations require students to select a centre of rotation, a direction of rotation, and the amount or angle of rotation.
 - Students may be in a line with the group rotating around one end, the middle, or any point within the line, or they may rotate around another point away from the line.
 - They may also rotate in the formation of a triangle or a rectangle.

Variations:

- Assign one transformation to each group. Each group prepares a thorough presentation, complete with multiple examples.
- Have students work inside the classroom in pairs, performing the demonstrations with multiple objects rather than with their bodies. In place of presentations, students individually draw their example(s) and write an explanation in their math journals.

Observation Checklist

- Listen to and observe students' responses to determine whether students can do the following:
 - Perform and describe translations.
 - Perform and describe reflections.
 - Perform and describe rotations.



Assessing Prior Knowledge

Materials:

- grid paper (three for each student)
- polygon cut-outs from grid paper or pattern blocks, or some other small angular flat objects
- math journals
- Miras (optional)
- tracing paper (optional)
- push-pins (optional)

Organization: Whole class, individual or pairs

Procedure:

1. Have students practise demonstrating transformations. Direct students to place an object on the grid paper and demonstrate different types of transformations.
 - a) Translations (slides up, down, right, or left, and diagonally)
 - b) Reflections (flips over different lines of reflections in different directions)
Use Miras to perform or confirm the reflections.
 - c) Rotations about a point of rotation
Vary the points of rotation to include vertices and points inside and outside the object. Tracing paper and push-pins may be used to perform or confirm the rotations.
2. Review notations. Model recording the various transformations, and review correct labelling.
 - a) Label the vertices of the pre-image with capital letters (ABC) and label the corresponding vertices of the image with the letter, followed by a prime mark (A'B'C'). Successive images are labelled with additional prime marks (A''B''C''), and so on.
 - b) Include symbols for slide arrows, lines of reflection or mirror lines, the centre of rotation, and the direction and amount of rotation.
 - c) Translations are commonly written using slide arrows or using coordinate notation with square brackets (e.g., 3 left, 2 up is written as $[-3, 2]$).
 - d) Reflections are written as reflected in the line (e.g., reflected in the line $x = 3$).
 - e) Rotations are commonly written using a degree measure and direction (e.g., 90° ccw).

3. Model descriptions of movement. Have students describe the change between the pre-image and the image.

Examples:

- The triangle was translated 3 to the right, and so the pre-image and image hold the same orientation.
 - The square was reflected through the line $x = 1$, and so the image looks as though a mirror was held on the right-hand side of it. The image looks inverted.
 - The rectangle was rotated 90° counter-clockwise around point B, and so the image has B in the same place, but now A is below B.
4. Have students record some transformations. Ask them to use one grid paper for each type of transformation and include a few examples of each.
 - a) Remind students to include mirror lines and centres of rotation.
 - b) They may record combinations or successive transformations using the same pre-image, or use various pre-images and separate transformations.
 - c) Have students include descriptions of the transformations they record.
 - d) Some students may repeat successive transformations of one pre-image to create design patterns, as demonstrated on the following website.

Sample Website:

Wolfram Demonstrations Projects. *Symbol Rotation Patterns*.

<http://demonstrations.wolfram.com/SymbolRotationPatterns/>.

5. Post students' displays when they are complete.
6. Meet as a class for a quick debriefing.
 - a) Discuss what students learned or were reminded of during this learning experience, as well as any difficulties they faced and how they overcame them.
 - b) Have students make a record of their learning in their math journals.

Variations:

- Provide grid paper with some shapes already sketched on the paper, and provide specifications for some transformations. Have students perform the transformations and label the images. In place of the sketches, provide the ordered pairs for the vertices of the pre-images and have students plot the pre-images and images.
- Have students sketch pre-images, specify transformations, prepare a key, and exchange papers with a partner, who will create the images. Then students return the papers to each other, verify responses, and discuss any discrepancies.
- Various games and exercises involving transformations are available online.

Sample Website:

To explore reflections in different mirror lines or rotations with lines of symmetry, refer to the following website:

MathIsFun.com. "Symmetry Artist." *Geometry*. 2011.

www.mathsisfun.com/geometry/symmetry-artist.html.

Observation Checklist

- Listen to and observe students' responses to determine whether students can do the following:
 - Plot points in the first quadrant of a Cartesian plane.
 - Perform transformations of translations.
 - Perform transformations of reflections.
 - Perform transformations of rotations.
 - Record transformations.
 - Describe transformations.

Suggestions for Instruction

- Describe the horizontal and vertical movement required to move from a given point to another point on a Cartesian plane.
- Describe the positional change of the vertices of a 2-D shape to the corresponding vertices of its image as a result of a transformation or successive transformations on a Cartesian plane.
- Perform a transformation or consecutive transformations on a 2-D shape, and identify the coordinates of the vertices of the image.

Materials:

- grid paper labelled as a Cartesian plane
- one number cube and one coin (or spinners with integers) for each pair of students
- BLM 7.SS.5.1: Comparing Points

Organization: Whole class, pairs

Procedure:

1. Place students in pairs.
2. Distribute copies of BLM 7.SS.5.1: Comparing Points, along with the number cubes and coins.
3. Demonstrate the process of generating points.
 - a) Assign meaning to the manipulatives (e.g., heads represent positive, tails represent negative, six represents 0).
 - b) Roll the number cube and toss the coin to determine an x -coordinate, and then repeat the process for a y -coordinate. (Try to work without plotting the points). Call the point A, and record the point and coordinates in the chart.
 - c) The partner rolls and tosses to identify the next coordinate, labels it B, and records the coordinates. Compare the position of the new point to the old point. Discuss responses and justifications.
4. Ask students to follow the above method for generating points as they complete BLM 7.SS.5.1: Comparing Points.
5. Circulate among students as they work with their partners, and monitor whether they are on track.
6. After students have had sufficient time to work in pairs, reassemble as a class and discuss what students learned.

Variations:

- Have students continue the learning activity and generate a new set of three to five points, connect them into a polygon, and follow the pattern of question 3 (on BLM 7.SS.5.1) with the new shape. Have students choose any transformation, or successive or combined transformations. Ask them to try predicting the location of the images and then confirm the location by plotting them. Students can create their own Cartesian planes on grid paper and charts.



Observation Checklist

- Listen to and observe students' responses to determine whether students can do the following:
 - Describe the horizontal and vertical movement required to move from a given point to another point on a Cartesian plane.
 - Describe the positional change of the vertices of a 2-D shape to the corresponding vertices of its image as a result of a transformation or successive transformations on a Cartesian plane.
 - Perform a transformation or consecutive transformations on a 2-D shape, and identify the coordinates of the vertices of the image.

Suggestions for Instruction

- **Describe the horizontal and vertical movement required to move from a given point to another point on a Cartesian plane.**

Materials:

- BLM 7.SS.5.2: A Coordinate Map and/or blank grid paper

Organization: Individual or pairs

Procedure:

1. Decide whether or not you will need to discuss and demonstrate notations, describing movements as units left, right, up, and down, and describing changes in terms of change in each coordinate, or if students have sufficient background knowledge to proceed from the examples.
2. Introduce BLM 7.SS.5.2: A Coordinate Map.
 - Maps provide small visuals of much larger spaces. They show how locations are related to one another and they provide a way to communicate about the locations of different places.

- Encourage students to be creative with their maps. They may represent any place, ranging from their desks to anywhere in the world, actual or imagined.
- 3. Have each student plot and label several locations on the grid and create a key, following the directions in step 1 of BLM 7.SS.5.2: A Coordinate Map.
- 4. In step 2, when making trips around the community, students may work individually or with a partner.
 - Students look at one map at a time.
 - The partner tells the mapmaker which trip to make.
 - The mapmaker records the trip on the chart, determines the movement, and records it.
 - The partner verifies whether the information is correct.
- 5. Students draw a Cartesian plane on their grid.
 - Students title the final column of the key and the fourth column of the grid Coordinates of Trip.
 - They record the coordinates of the places on the map and the trips.
 - Partners verify each other's work.
- 6. Have students complete the final column, describing the movement between coordinates in terms of change in the x - and y -coordinates.
 - A positive change in y is an upward movement, and a negative change represents a downward movement.
 - For the x -coordinate, a positive change is right and a negative change is left.

Variations:

- Students can prepare directions for a partner to plot. First they plot the points, specify the trip, or describe movements. Partners exchange papers and complete the missing information, and then return papers to each other and verify each other's work.
- The teacher plots and labels the points on the grid, and fills in some coordinates and descriptions of movements on the trip chart before distributing it to students. Students determine the trip destinations. This allows the teacher a little more control over the learning activity, and provides experiences for students to work the moves backwards.



Observation Checklist

- Listen to and observe students' responses to determine whether students can do the following:
 - Describe the horizontal and vertical movement required to move from a given point to another point on a Cartesian plane.

Suggestions for Instruction

- **Identify the coordinates of the vertices of a 2-D shape on a Cartesian plane.**
- **Describe the positional change of the vertices of a 2-D shape to the corresponding vertices of its image as a result of a transformation or successive transformations on a Cartesian plane.**
- **Perform a transformation or consecutive transformations on a 2-D shape, and identify the coordinates of the vertices of the image.**
- **Describe the image resulting from the transformation of a given 2-D shape on a Cartesian plane by comparing the coordinates of the vertices of the image.**

Materials:

- BLM 7.SS.5.3: Cartesian Plane Map and UFO Templates
- BLM 7.SS.5.4: Exploring Transformations: UFO Pilot Training
- BLM 7.SS.5.5: Recording Transformations: Travel Logbook
- Cartesian plane and triangle shape to fit the grid (for demonstration)
- Miras
- tracing paper
- push-pins (optional)
- scissors (optional)

Organization: Whole class, pairs or small groups, individual

Procedure:

Preparation

1. Tell students they will be exploring transformations to gain experience to pilot an unidentified flying object (UFO) accurately on a Cartesian plane.
2. Distribute copies of BLM 7.SS.5.3: Cartesian Plane Map and UFO Templates and two triangles per student, or have students prepare their own planes and triangles.

Part A: Demonstration (whole class)

3. Demonstrate, or have a student demonstrate, various transformations of the UFO on the grid provided. The purpose of the demonstration is to ensure that students have the skill to explore productively on their own.
 - Students can mimic the demonstration using their own grid.
 - Ask a student to identify the coordinates of the shape.
 - Tell students what transformation to make. Remember to include lines of reflection, and points, degree, and direction of rotation.

- Transform, or have a student transform, the UFO and identify the coordinates of the image.
- Discuss the movements and descriptions that would compare the position of the image to the position of the shape or pre-image.
- Record the coordinates and various descriptions as a model for later reference.
- Try varying the information given and required.

Examples:

- State coordinates of the shape, supply a description of the movement, and ask students to identify the coordinates of the image and/or a possible transformation.
 - Have students identify the coordinates of a shape, given the coordinates of the image and a description of the transformation.
 - Supply students with coordinates of the shape and the image, and ask them to identify a possible transformation.
 - Include demonstrations of successive transformations and combinations of transformations. More than one transformation can match the same description and result in the same image.
4. When students are ready to explore piloting the UFO, move to Part B of this learning activity.

Part B: Exploration (pairs or small groups)

5. Distribute copies of BLM 7.SS.5.4: Exploring Transformations: UFO Pilot Training.
6. Tell students they will explore transformations, with the aim of being able to control the UFO and pilot it to and from specific locations.
7. Have students work in pairs or in small groups to explore describing and predicting the images created by transforming the UFO. The BLM provides some reminders and suggestions, as well as a chart for recording observations.
8. When students feel competent, have them try some intentional trips, using different transformations to move between two points on the Cartesian plane map. Use the vertex O as the on/off point that must touch the points found on the Cartesian plane map (BLM 7.SS.5.3: Cartesian Plane Map and UFO Templates).
9. Students can challenge each other to find the most efficient transformations, or alternate transformations, to travel between points.
10. When they are successful, they are ready for Part C of this learning activity.
11. Issue UFO licences if you wish.

Part C: Transformation Travel (individual)

12. Distribute copies of BLM 7.SS.5.5: Recording Transformations: Travel Logbook. Students will need their copies of BLM 7.SS.5.3: Cartesian Plane Map and UFO Templates and their UFO triangles.
13. Decide on the number of trips to be completed and any specific transformations, or alternate routes, the pilots must make to complete their mission (e.g., make it to point F in less than five trips using at least two different transformations).
14. Have students label the plotted points to represent location destinations on their maps.
15. Have students pilot their UFO from one location to another using transformations, and ask them to complete BLM 7.SS.5.5: Recording Transformations: Travel Logbook. A trip takes vertex O (on/off) from one location point to the other.

Variations:

- Hold a UFO derby. Students compete to see who can travel from one destination to another using the fewest transformations. (Translations count as one transformation per unit.)
- Students can explore and practise transformations using computer transformation software, applets, or games.

Sample Websites:

The following websites allow students to transform squares, parallelograms, and triangles.

BBC. "Shape, Space and Measures." *KS2 Bitesize*. 2011.

www.bbc.co.uk/schools/ks2bitesize/maths/shape_space/transformation/play.shtml.

In this computer game, students choose a mirror line or rotation points to reflect a pentagon house onto its shadow.

Reed, Jim. "33.01 The Coordinate Plane." *Grade 7: The Learning Equation Math*. 1999.

<http://staff.argyll.epsb.ca/jreed/math7/strand3/3301.htm>.

Directions are displayed with the applet.

Shodor. "Transmographer." *Interactive*. 1994–2011.

www.shodor.org/interactivate/activities/Transmographer/.



Observation Checklist

- Listen to and observe students' responses to determine whether students can do the following:
 - Identify the coordinates of the vertices of a 2-D shape.
 - Describe the horizontal and vertical movement required to move from a given point to another point on a Cartesian plane.
 - Describe the positional change of the vertices that result from a transformation or from successive transformations.
 - Perform a transformation or consecutive transformations on a 2-D shape, and identify the coordinates of the vertices of the image.
 - Describe the image resulting from the transformation of a shape by comparing the coordinates of the vertices of the image to the vertices of the pre-image.

Suggestions for Instruction

- **Identify the coordinates of the vertices of a 2-D shape on a Cartesian plane.**
- **Describe the positional change of the vertices of a 2-D shape to the corresponding vertices of its image as a result of a transformation or successive transformations on a Cartesian plane.**
- **Perform a transformation or consecutive transformations on a 2-D shape, and identify the coordinates of the vertices of the image.**
- **Describe the image resulting from the transformation of a given 2-D shape on a Cartesian plane by comparing the coordinates of the vertices of the image.**

Materials:

- BLM 7.SS.5.6: Creating a Design Using Reflections
- grid paper
- rulers
- art supplies (for designs)
- display board
- file cards (optional)
- transformation software, draw programs, computer applets (optional)

Organization: Individual, whole class

Procedure:

1. Distribute copies of BLM 7.SS.5.6: Creating a Design Using Reflections. Have students follow instructions to
 - plot a five-sided shape
 - reflect the shape on the y -axis
 - reflect the expanded shape on the x -axis to create the design
 - describe the changes between the initial shape and the images
2. Have students create their own symmetrical design by creating a basic shape and one or more transformations. Ask them to include
 - a plot of the shape and its images on a Cartesian plane
 - a chart of the coordinates of the shape and its images
 - directions for creating the image (written on a file card)
 - a description of the changes between the shape and its images
3. Have students colour and frame their designs. Post the designs and the directions on a display board.
4. Hold a class debriefing session in which students share their designs, and discuss difficulties and solutions they encountered while creating the designs.

Variations:

- Explore creating designs using transformation software, draw programs, or computer applets.
- Add the file cards with design directions to a box from which students can draw cards and follow the directions to create designs.



Observation Checklist

- Listen to and observe students' responses to determine whether students can do the following:
 - Identify the coordinates of the vertices of a 2-D shape.
 - Describe the positional change of the vertices that result from a transformation or from successive transformations.
 - Perform a transformation or consecutive transformations on a 2-D shape, and identify the coordinates of the vertices of the image.
 - Describe the image resulting from the transformation of a shape by comparing the coordinates of the vertices of the image to the vertices of the pre-image.

Suggestions for Instruction

- **Identify the coordinates of the vertices of a 2-D shape on a Cartesian plane.**
- **Perform a transformation or consecutive transformations on a 2-D shape, and identify the coordinates of the vertices of the image.**

Materials:

- BLM 7.SS.5.7: Which Plot Is Correct?
- number cubes
- rulers
- grid paper
- Miras (optional)
- tracing paper (optional)
- computer software or applets (optional)

Organization: Individual, whole class

Procedure:

1. Inform students that in this learning activity they will perform transformations on designated shapes.
2. Randomly assign shapes and transformations to each student. A suggested method follows:
 - Present six possible shapes and assign each a number from 1 to 6.

Examples:

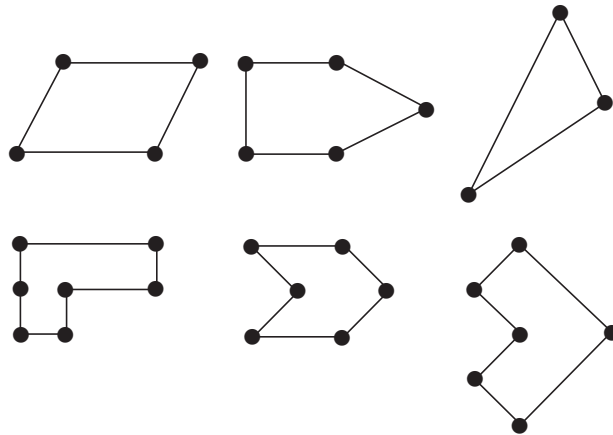

- List six types of transformations you would like students to practise, and assign each a number from 1 to 6.

Suggestion:

1—translation

2—rotation inside shape

3—reflection inside the shape

4—rotation outside the shape

5—reflection outside the shape

6—combination

- Students roll a number cube to determine the shape and transformation(s) with which they will work.
3. Students individually plot their assigned shape on grid paper, choosing their own scale and coordinates to create the vertices of their shape.
 4. Students choose details for their assigned transformation, and perform it on the shape.
 5. Students write their name, draw a small diagram of their shape, provide a list of points and coordinates for the shape and image, and write directions for the transformation on the grid paper. This product will be used later in this learning activity.
 6. Provide each student with a copy of BLM 7.SS.5.7: Which Plot Is Correct? Have students use the shape and transformation they made to create a multiple-choice puzzle on BLM 7.SS.5.7: Which Plot Is Correct?
 - Plot the correct shape in one of the locations A to D.
 - Plot the correct image in another box A to D.
 - Plot the shape and image incorrectly in the two remaining boxes. Suggest that students try not to be obvious as they create their errors.
 7. Chronologically assign each student a puzzle number to write on his or her sheet, and on the original grid paper plot, which is the solution key.
 8. Have students exchange papers with 10 or so people, and answer the puzzles in a chart like the one on page 2 of BLM 7.SS.5.7: Which Plot Is Correct?
 9. Students return all puzzles to their creators.
 10. Ask students to share the correct solutions to the puzzles by taking turns reading their puzzle number, and the correct letters for the shape and the image.
 11. As a class, discuss any discrepancies identified, and refer to the original grid paper to correct any errors.
 12. Store the puzzles and original plots in a folder for students to solve at other times.

Variations:

- Prepare several puzzles, copy them, and give the same sheet to each student to solve.
- Provide students with a list of coordinate points and transformation directions, and have them produce the coordinates for the image.



Observation Checklist

- Listen to and observe students' responses to determine whether students can do the following:
 - Identify the coordinates of the vertices of a 2-D shape.
 - Perform a transformation or consecutive transformations on a 2-D shape, and identify the coordinates of the vertices of the image.

PUTTING THE PIECES TOGETHER

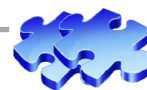

Golf Tournament or Animations

Introduction:

On easel pad grid paper, students will create a plan for a golf course that includes nine holes. The goal will be for a partner to complete the course with the fewest possible transformation “strokes.”

Purpose:

In this investigation, students will demonstrate the ability to do the following (learning outcome connections are identified in parentheses):

- Construct circles with a given radius. (7.SS.1)
- Construct perpendicular and parallel line segments and bisectors. (7.SS.3)
- Perform and describe transformations of 2-D shapes in the four quadrants of a Cartesian plane. (7.SS.5)

Students will also demonstrate the following mathematical processes:

- Communication
- Connections
- Mental Mathematics and Estimation
- Problem Solving
- Reasoning

Materials/Resources:

- BLM 5–8.25: My Success with Mathematical Processes
- grid paper, easel pad grid paper, and poster paper
- ruler, compass, and protractor
- calculator
- art supplies
- animation software (optional)

Organization: Individual or pairs

Procedure:

Student Directions

1. Draw an x -axis and a y -axis centred on a large piece of easel pad grid paper.
2. On this Cartesian plane, begin drawing a golf course. Start by placing nine numbered tees on the plane. Then draw numbered holes for each tee, making sure you put the hole in a different quadrant than its corresponding tee. Paths from tees to holes may overlap or cross each other. Holes and tees should be placed on whole-number ordered pair coordinates, not between them.

3. Add the following eight obstacles on your nine-hole golf course, making sure you do not overlap these with any holes or tees:
 - a) two water traps, with a 10 cm diameter
 - b) two sand traps, with a radius of 7 cm and 5 cm
 - c) two treed areas, with a radius of 3 cm and 4 cm
 - d) two parallel rows of trees 20 cm by 2 cm
4. Play each other's golf courses by using transformations to move an imaginary ball from its tee to its hole. The goal is to complete the course with the fewest possible transformations, but only the following transformations are allowed:
 - a) a translation directly left or right by up to 4 units
 - b) a translation directly up or down by up to 4 units
 - c) a clockwise or counter-clockwise rotation of 90° , 180° , or 270° , with a whole-number coordinate pair as the centre of the rotation
 - d) reflections across the horizontal and vertical lines

Balls cannot rest on obstacles, but can move over or around them.
5. Complete BLM 5–8.25: My Success with Mathematical Processes.



Observation Checklist

- Listen to and observe students' responses to determine whether students can do the following:
 - Construct circles of a given radius.
 - Construct parallel lines.
 - Describe transformations in the four quadrants of a Cartesian plane.

Extension:

Use animation software to create an animation based on transformations. Animations may include the following:

- a nature scene in which the sun comes up, travels through the sky, and sets, while a creature visits different places, finding food, drinking water, or hiding. Include a combination of jumping, sliding, turning, and spinning movements.
- a park scene with playground equipment, a play area, a garden area, a picnic area, entrances, and so on
- an amusement park with rides and concessions
- a city scene with a bank, a theatre, stores, restaurants, bus stops, medical offices, and so on
- a basketball or hockey game with a court or a rink drawn to scale



GRADE 7 MATHEMATICS

Statistics and Probability

Statistics and Probability (Data Analysis)

(7.SP.1, 7.SP.2)

Enduring Understanding(s):

Data can be described by a single value used to describe the set.

General Learning Outcome(s):

Collect, display, and analyze data to solve problems.

SPECIFIC LEARNING OUTCOME(S):	ACHIEVEMENT INDICATORS:
<p>7.SP.1 Demonstrate an understanding of central tendency and range by</p> <ul style="list-style-type: none"> ■ determining the measures of central tendency (mean, median, mode) and range ■ determining the most appropriate measures of central tendency to report findings <p>[C, PS, R, T]</p>	<ul style="list-style-type: none"> → Determine the mean, median, and mode for a set of data, and explain why these values may be the same or different. → Determine the range of a set of data. → Provide a context in which the mean, median, or mode is the most appropriate measure of central tendency to use when reporting findings. → Solve a problem involving the measures of central tendency.
<p>7.SP.2 Determine the effect on the mean, median, and mode when an outlier is included in a data set.</p> <p>[C, CN, PS, R]</p>	<ul style="list-style-type: none"> → Analyze a set of data to identify any outliers. → Explain the effect of outliers on the measures of central tendency for a data set. → Identify outliers in a set of data and justify whether or not they are to be included in the reporting of the measures of central tendency. → Provide examples of situations in which outliers would or would not be used in determining the measures of central tendency.

PRIOR KNOWLEDGE

Students may have had experience with the following:

- Differentiating between first-hand and second-hand data.
- Comparing the likelihood of two possible outcomes occurring, using words such as
 - less likely
 - equally likely
 - more likely
- Creating, labelling, and interpreting line graphs to draw conclusions.
- Selecting, justifying, and using appropriate methods of collecting data, including
 - questionnaires
 - experiments
 - databases
 - electronic media
- Graphing collected data and analyzing the graph to solve problems.

For more information on prior knowledge, refer to the following resource:

Manitoba Education and Advanced Learning. *Glance Across the Grades: Kindergarten to Grade 9 Mathematics*. Winnipeg, MB: Manitoba Education and Advanced Learning, 2015. Available online at www.edu.gov.mb.ca/k12/cur/math/glance_k-9/index.html.

RELATED KNOWLEDGE

Students should be introduced to the following:

- Comparing and ordering fractions, decimals (to thousandths), and integers by using
 - benchmarks
 - place value
 - equivalent fractions and/or decimals
- Constructing, labelling, and interpreting circle graphs to solve problems.
- Expressing probabilities as ratios, fractions, and percents.
- Identifying the sample space (where the combined sample space has 36 or fewer elements) for a probability experiment involving two independent events.
- Conducting a probability experiment to compare the theoretical probability (determined using a tree diagram, table, or another graphic organizer) and experimental probability of two independent events.

BACKGROUND INFORMATION

Students live in an information age that abounds with data. Various media continually offer information on fashion, entertainment, sports, finances, safety, health, and world events. Students encounter data regularly at school, in their marks, in science experiments, in social studies information, and so on. To be helpful, data needs to be categorized and understood.

Statistics help reduce large quantities of data to single values. The single value makes it much simpler to conceptualize and communicate about the information contained in the data. Statistics, however, are sometimes manipulated or presented in a manner that uses facts to mislead people and sway their opinions. By studying statistics, students develop their ability to understand and evaluate information presented in advertising, politics, and news reports, and to communicate their experience with data.

Measures of Central Tendency

In previous grades, students collected data first hand and from electronic sources, and learned when to use each source. In Grade 7, students are introduced to three statistical measures of central tendency: mean, median, and mode. Each is a numeric value attempting to represent an entire set of data. Each measure is an average with its own focus, strengths, and weaknesses. The more symmetrical the set of data is, the closer the measures of central tendency will be to one another. The more skewed the set of data is, the greater the difference between the values will be. The different measures are best used in different situations, although sometimes all three measures provide meaningful representations of the data.

The measures of central tendency and range are discussed below:

- **Mean:** The arithmetic *mean* is commonly referred to as average, and is commonly used to assign student grades. The mean is the measure of central tendency most affected by outliers; therefore, it is best used when the range of values in the set is narrow. To find the mean, combine all the values in the set and then evenly redistribute them. The algorithm for calculating the mean is to sum all values in the set, and divide the combined value by the number of values in the set. The mean can also be found by finding the central balance point on a number line.

Example:

Given the numbers 3, 4, 6, 3, 3, 9, 7,

a) plot the numbers on a number line



- b) move the numbers toward the centre, allowing one move to the left for every one move to the right

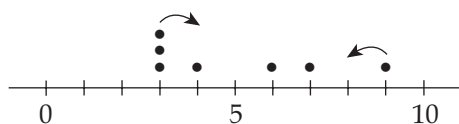

- c) continue this process until the numbers line up on one point

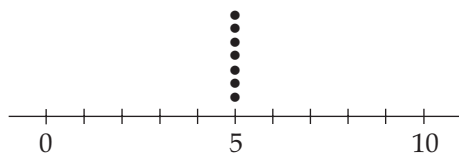

- **Median:** The *median* is the middle value in an ordered set of data. The median is easy to understand and easy to determine. To find the median, place all the values in the set, including repeated numbers, in numerical order and select the value in the middle. If there is no single middle value, add the two middle numbers together and divide by two. Because the median is the middle value, half the values in a data set will be greater than the median and half the values will be less than the median. The median represents the 50th percentile. (**Note:** Formal study of percentiles occurs in Grade 12 Essential Mathematics.) The median is less affected by outliers; therefore, it is more stable. It is the most appropriate measure of central tendency to represent a set of data containing extreme values.
- **Mode:** The *mode* is the most commonly occurring item in a set. A set of data may not have a mode, or it may have one mode, be bimodal, or have multiple modes. The mode may or may not indicate the centre of the data it represents. Generally, *outliers* (extreme values at either the high or the low end of the range) do not affect modes. Modes are very unstable, however, and a small change in the data can drastically change the mode. Because the mode identifies the most typical item in a set, it is useful for predicting the case in a particular situation. For example, if the mode for shirts sold is size 10, the buyers for a store can use the mode to help them decide which sizes to stock in the store's inventory.
- **Range:** The *range* describes a set of data by identifying the difference between the greatest value and the least value in a data set.

Understanding how and when to use the different statistical values gives students the ability to understand and communicate about data more clearly, and to use data wisely to make informed decisions.

When planning for student learning experiences, choose learning activities that emphasize concepts and understanding. Have students gather data for the purpose of answering questions. Allowing students to ask their own questions and collect their own data provides contexts and purposes for analyzing data and for exploring the different statistics. Students may, for example, wish to compare their classmates' habits or physical skills, integrate science or social studies content, or answer questions about world conditions or trends.

MATHEMATICAL LANGUAGE

average
data
mean
measure of central tendency
median
mode
outlier
range
statistics
Venn diagram

LEARNING EXPERIENCES



Assessing Prior Knowledge

Materials:

- grid paper
- rulers

Organization: Individual or pairs

Procedure:

1. Review the concepts of formulating questions, collecting first- or second-hand data, and preparing bar graphs.
2. Have students work individually, or in pairs, to do the following:
 - a) Formulate a survey question about peers that can be answered with numeric values.

Sample Questions:

- How many siblings are in your family? How many pets (or cell phones, televisions) does your family have?

- How many times a week do you eat a particular food, watch a movie, or participate in physical activity?
 - How many hours do you sleep per night?
 - How tall are you?
 - How many pairs of mittens (or shoes, pants) do you own?
 - How many countries have you visited?
 - Compare the heights (or heart rates, lengths of names) of boys and girls in the class.
- b) Gather the information.
- c) Display the data in a bar graph.
- d) Formulate a question about the population of the survey that could be answered using the information from the graph. Include an answer key to the question.
3. Have students present and display their work. These data sets can be used for subsequent learning experiences.

Variations:

- Have students choose a question and create bar graphs from data you provide or from the school census data available online.
- Rather than having students conduct surveys, have them research sources to collect data to answer specific questions (e.g., temperatures or rainfall amounts over a certain period of time, sizes of farms in a region, the price of a commodity).

Observation Checklist

- Listen to and observe students' responses to determine whether students can do the following:
 - Pose a survey question that can be answered with numeric values.
 - Conduct a survey or search resources to obtain data.
 - Display data in a bar graph.

Suggestions for Instruction

- **Determine the mean, median, and mode for a set of data, and explain why these values may be the same or different.**
- **Determine the range of a set of data.**

Materials:

- bar graphs from the surveys conducted in the previous learning experience (Assessing Prior Knowledge)
- presentation board
- math journals

Organization: Individual or pairs, whole class

Procedure:

1. Remind students that their surveys and graphs reveal interesting information about their peers.
2. Ask students to use the information in their graphs to create a general statement about a “typical” or average student in the class, or grade, or whatever group they surveyed.

Examples:

- How many siblings does a typical Grade 7 student have?
 - How many times does the typical Grade 7 student eat French fries in a week?
3. Have students work individually or with their partners to determine the best answer to their question, explain how they arrived at the answer, and explain why the answer represents a typical student.
 4. Reassemble as a class and have students share their questions, answers, explanations, and justifications.
 5. During the class discussion, encourage students to comment on and ask questions about their classmates’ responses, and to present alternative answers.
 6. Introduce vocabulary related to statistics as topics present themselves during the sharing.
 7. Record the vocabulary on a presentation board. Include the three measures of central tendency (*mean*, *median*, and *mode*), the *range*, and *outliers* (if they are present).
 - a) If students choose the most frequent response to represent the average student, introduce *mode*.
 - b) If they find the arithmetic mean, or redistribute the items, introduce *mean* and discuss the methods they used to determine the value.
 - c) If they use the middle value, introduce *median* and discuss the methods of finding the median.

- d) If they discuss the range of values, introduce the *range* as the difference between these values.
 - e) If they mention anomalies such as a very high or very low value, introduce *outliers*.
8. Inform students that in using one value to represent a range of data, they have been exploring statistical measures of central tendency. Measures of central tendency will be studied in greater detail in the following learning experiences.
9. Have students record the new vocabulary terms and what they have learned about them in their math journals.

Variations:

- Have students combine the information from several surveys to create a profile of the typical Grade 7 student.
- Rather than using student survey data, provide students with several questions and sets of data. For example, provide data for several styles of T-shirts, each selling for a different price. Ask what would be a fair price for the T-shirts if they all sold for the same price. Or supply data for the amount of money individual students raised for a class trip. Ask how much money a typical student raised.



Observation Checklist

- Listen to and observe students' responses to determine whether students can do the following:
 - Demonstrate an understanding of mean, median, and mode for a set of data, and explain why these values may be the same or different.
 - Demonstrate an understanding of the range of a set of data.

Suggestions for Instruction

- **Determine the mean, median, and mode for a set of data, and explain why these values may be the same or different.**
- **Determine the range of a set of data.**

Materials:

- BLM 7.SP.1.1: Finding the Centre of a Graph and Comparing the Values
- bar graphs from the previous learning experience or supplied data
- modelling clay, coloured cubes or blocks, and/or counters
- grid paper (1 cm)
- transparent rulers or grid strips
- presentation board
- math journals
- BLM 7.SP.1.2: Exploring Measures of Central Tendency (optional)

Organization: Individual or pairs, whole class

Procedure:

1. Distribute copies of BLM 7.SP.1.1: Finding the Centre of a Graph and Comparing the Values, and have students work individually or with a partner to complete it. Then reassemble as a class and discuss what students discovered.
2. Alternately, guide the class through the steps and have them record their learning in their math journals.
 - a) Have students, working individually or in pairs, build a concrete model of their own graph, or a classmate's graph. Alternatively, supply students with data and have them prepare a graph and a model for the data. Students may use cubes or blocks, counters, and/or 1 cm grid paper and modelling clay.
 - b) When students have completed their graphs, ask them to do the following:
 - Identify the range for the data represented in their graph, and record it (subtract the least value from the greatest value). Rearrange the graph to emphasize the range.
 - Identify any outliers or extreme values in the graph.
 - Find the mode, or most frequent value, represented in their graph, and record it. Explain how the graph could be rearranged to emphasize the mode.
 - Find the median or middle value in their graph, and record it. Explain how the graph could be rearranged to emphasize the median.
 - c) Ask students to explore, on their own or with their partner, how to level the data and find its centre, or balance point. Emphasize that this is not the middle value or median. Students will be rearranging their graphs to emphasize the centre of the data, or the mean. They record the mean.

3. Have students reassemble as a class and share what they did to level the data, and discuss any questions or comments that arise. Strategies for levelling the data could include the following:
 - a) Compress the modelling clay graph, while holding the sides and surface firm.
 - b) Rearrange the blocks by taking blocks from the longer bars and placing them on the smaller bars until they are similar in height. If whole blocks cannot be shared evenly, it may be necessary to share fractions of a block.
 - c) Place a ruler perpendicular to the bars of the graph, and adjust the position of the ruler until there are an equal number of blocks above the line and below the line. It may be necessary to position the ruler within a block if the mean is not a whole number.
4. Have students compare their three values, mode, median, and mean, and determine whether they each represent the data well, or whether one value represents the data better than the others, and why that may be.
5. Share students' reflections and discuss how each value is a measure of central tendency or a way to represent the average value. When the data set has a small range, the average values are similar, and each represents the graph. When there are outliers in the data, or the range is wide, the averages may be quite different from each other, and no average by itself represents the data well. Different measures are better for different situations, and sometimes more than one measure is needed to represent the data.

Variations:

- Supply students with graphs of data that controls the value of the averages (i.e., a whole-number mean if students are not prepared to work with decimals or fractions), or control the presence of modes or outliers.
- Have students rearrange the values of the bars to create multiple bar graphs that have the same mean. Ask why the different graphs have the same mean.
- Have students explore what effect rearranging the values of the bars of the graphs have on each of the average values. See BLM 7.SP.1.2: Exploring Measures of Central Tendency.



Observation Checklist

- Listen to and observe students' responses to determine whether students can do the following:
 - Determine the mean, median, and mode for a set of data, and explain why these values may be the same or different.
 - Determine the range of a set of data.
 - Use reasoning and visualization to determine measures of central tendency.

Suggestions for Instruction

- **Determine the mean, median, and mode for a set of data, and explain why these values may be the same or different.**
- **Determine the range of a set of data.**

Materials:

- demonstration board
- magnets or self-stick notes
- number lines
- Unifix® or linking cubes
- BLM 7.SP.1.2: Exploring Measures of Central Tendency (optional)

Organization: Pairs, whole class

Procedure:

1. Review the three types of averages (mode, median, and mean), and how students found these values using graphs.
2. Present a set of data such as the following: 3, 4, 6, 3, 3, 9, 7. Ask students to use a Think-Pair-Share strategy (think about the question individually, discuss ideas with a partner, and then share responses with the class) to do the following:
 - a) Identify the range in the data.
 - b) Identify and explain how to determine the mean without making a graph.
 - c) Identify and explain how to determine the median without making a graph.
 - d) Identify and explain how to determine the mode without making a graph.
3. Introduce students to using a number line to find the centre of the data.
 - a) Draw a number line on the demonstration board from 0 to 10.
 - b) Place a square to represent each value on the corresponding point of the number line. Magnets or self-stick notes work well on a chalkboard or whiteboard. (In the data set specified above, there are three number 3s, so place three squares on 3.)
 - c) The goal is to find the centre of all these values. Systematically move the self-stick notes from each end toward the centre until all the notes are stacked up on one point (e.g., a move of two jumps from the right toward the centre must be countered by a move of two jumps from the left toward the centre).
 - d) For the above data set, the blocks will all line up on the mean 5.

Variations:

- Have students practise determining the mean and explore the effect of different values on averages. Alter the values in the above data set, but maintain a set of seven digits with a sum of 35. Record the measures of central tendency for each set, using BLM 7.SP.1.2: Exploring Measures of Central Tendency. Compare the values for different sets of data.



Observation Checklist

- Listen to and observe students' responses to determine whether students can do the following:
 - Determine the mean, median, and mode for a set of data, and explain why these values may be the same or different.
 - Determine the range of a set of data.

Suggestions for Instruction

- **Determine the mean, median, and mode for a set of data, and explain why these values may be the same or different.**
- **Determine the range of a set of data.**
- **Provide a context in which the mean, median, or mode is the most appropriate measure of central tendency to use when reporting findings.**
- **Solve a problem involving the measures of central tendency.**
- **Analyze a set of data to identify any outliers.**
- **Explain the effect of outliers on the measures of central tendency for a data set.**
- **Identify outliers in a set of data and justify whether or not they are to be included in the reporting of the measures of central tendency.**
- **Provide examples of situations in which outliers would or would not be used in determining the measures of central tendency.**

Materials:

- BLM 7.SP.1.3A: Simone's Spelling Scores (Questions)
- BLM 7.SP.1.3B: Simone's Spelling Performance Record

Organization: Pairs or small groups, whole class (for Think-Pair-Share)

Procedure:

1. Distribute copies of BLM 7.SP.1.3A: Simone's Spelling Performance (Questions) and BLM 7.SP.1.3B: Simone's Spelling Performance Record.
2. Present a set of data such as Simone's spelling quiz results, scored out of 10. Her scores for the first seven quizzes were: 8, 8, 7, 9, 6, 10, and 8.
3. Ask students what score best represents Simone's spelling performance, and why they believe it to be so. In this set of data, the mean, median, and mode are all 8. The range is 4.
4. Simone writes three more quizzes, with scores of 3, 7, and 8. Have students identify and support her performance level now (mean 7.4, median 8, mode 8, range 7).
5. On the last three quizzes, Simone receives scores of 9, 10, and 0. Have students identify which one number will represent Simone's spelling performance. Ask students to support their choice using measures of central tendency and range (mean 7.2, median 8, mode 8, range 10).
6. Discuss students' choices and reasons. Include a discussion of
 - a) the effect of outliers on the mean, median, and mode
 - b) the influence of the range on the different measures
 - c) possible reasons for the outliers (e.g., didn't study, called to the office, cheated, lost quiz)
 - d) whether or not the outliers should be included in the data

Variations:

- Use students' own assignment or test scores.
- Use a different data set that does not represent school scores (e.g., prices for jeans, party sizes at a pizza restaurant, sizes of shoes or clothes).
- Have students research to obtain data to answer a question they pose.
- Have students generate random data to explore the effects of large outliers, or range size, on measures of central tendency.
- Ask students to analyze their findings and make a general statement regarding circumstances for which they recommend each measure of central tendency.



Observation Checklist

- Listen to and observe students' responses to determine whether students can do the following:
 - Determine the mean, median, and mode for a set of data, and explain why these values may be the same or different.
 - Determine the range of a set of data.
 - Provide a context in which the mean, median, or mode is the most appropriate measure of central tendency to use when reporting findings.
 - Solve a problem involving the measures of central tendency.
 - Analyze a set of data to identify any outliers.
 - Explain the effect of outliers on the measures of central tendency for a data set.
 - Identify outliers in a set of data, and justify whether or not they are to be included in the reporting of the measures of central tendency.
 - Provide examples of situations in which outliers would or would not be used in determining the measures of central tendency.

Suggestions for Instruction

- **Determine the mean, median, and mode for a set of data, and explain why these values may be the same or different.**
- **Determine the range of a set of data.**
- **Provide a context in which the mean, median, or mode is the most appropriate measure of central tendency to use when reporting findings.**
- **Solve a problem involving the measures of central tendency.**

Materials:

- BLM 7.SP.1.4: Using Central Tendency to Choose a Quarterback
- spinners (optional)

Organization: Individual, small groups, whole class

Procedure:

1. Remind students that the mean, median, and mode are all measures of central tendency that represent an entire set of data. Students will now use these measures to choose a quarterback for a football game.
2. Distribute copies of BLM 7.SP.1.4: Using Central Tendency to Choose a Quarterback, and ask students to complete the page individually.
3. Then have students meet in small groups to discuss their thinking. Each group will choose one quarterback, and a spokesperson will present and justify the group's choice to the class.
4. As groups present and defend their choices, encourage students to respond to presentations with comments and questions.
5. Discuss what to do with errors, and when each measure (mean, median, and mode) is best used.

Variations:

- Have students generate additional data by using a spinner with sections for 0, 5, 10, 15, 20, and 25 yards, and then ask them to recalculate the measures and re-evaluate their decisions.
- Have students generate data for additional quarterbacks. Question whether their decisions are based on the same measures each time.

**Observation Checklist**

- Listen to and observe students' responses to determine whether students can do the following:
 - Determine the mean, median, and mode for a set of data, and explain why these values may be the same or different.
 - Determine the range of a set of data.
 - Provide a context in which the mean, median, or mode is the most appropriate measure of central tendency to use when reporting findings.
 - Solve a problem involving the measures of central tendency.

Suggestions for Instruction

- **Provide a context in which the mean, median, or mode is the most appropriate measure of central tendency to use when reporting findings.**

Materials:

- BLM 7.SP.1.2: Exploring Measures of Central Tendency
- previously completed record sheets of data sets and measures of central tendency, including the information from the graphs produced in the Assessing Prior Knowledge learning experience
- spinners or pairs of number cubes (regular or multi-sided)

Organization: Pairs or small groups

Procedure:

1. Explain to students that they will be investigating sets of data to determine generalizations about which circumstances best match each measure of central tendency.
2. Have students work with a partner or in a small group.
3. Ask students to evaluate their previous records. If they require more data, or larger data sets, they can do the following:
 - a) Randomly generate new data sets by spinning spinners or by rolling the number cubes and multiplying the displayed numbers.
 - b) Research the legitimate answers to actual questions (e.g., salaries earned in specific companies, numbers of different sandwiches sold at a fast-food restaurant, flavours of ice cream sold, quantities of different drinks sold in the school cafeteria, teams winning championships).
4. Have students generate a list of guidelines for the types of data or circumstances they recommend for each measure of central tendency.
5. Discuss the guidelines as a class (refer to Background Information).



Observation Checklist

- Listen to and observe students' responses to determine whether students can do the following:
 - Provide a context in which the mean, median, or mode is the most appropriate measure of central tendency to use when reporting findings.

Suggestions for Instruction

- **Solve a problem involving the measures of central tendency.**
- **Identify outliers in a set of data and justify whether or not they are to be included in the reporting of the measures of central tendency.**
- **Provide examples of situations in which outliers would or would not be used in determining the measures of central tendency.**

Materials:

- data sets from previous learning experiences
- paper

Organization: Individual, pairs or small groups

Procedure:

1. Explain that in this learning activity students will demonstrate their understanding and use of measures of central tendency.
2. Have students, individually, create a realistic question and an accompanying data set on one side of a sheet of paper, and a detailed solution to the question on the reverse side of the paper.
 - Questions may include outliers that would or would not be used in determining the central tendency.
 - Solutions require the range, outliers, and the mean, median, and mode to be identified. Ask students to identify the best measure to reflect the centre of that data and justify the choice.
3. Students then share their questions with a partner or a small group and demonstrate their ability to use and choose measures of central tendency to solve problems.
4. When students have solved a problem, they check their solution and discuss any discrepancies with the creator of the problem.

Variations:

- Prepare additional problems and data sets for students who require them.
- Provide students with several problems and data sets, and ask them to provide solutions for each.
- Have a statistics challenge in which individual students compete to solve the problems in front of a classroom audience, or in which teams of students compete against one another to find the best measure of central tendency in each case.



Observation Checklist

- Listen to and observe students' responses to determine whether students can do the following:
 - Solve a problem involving the measures of central tendency.
 - Identify outliers in a set of data, and justify whether or not they are to be included in the reporting of the measures of central tendency.
 - Provide examples of situations in which outliers would or would not be used in determining the measures of central tendency.

Statistics and Probability (Data Analysis) (7.SP.3)

Enduring Understanding(s):

Circle graphs show a comparison of each part to a whole using ratios.

Percents, fractions, decimals, and ratios are different representations of the same quantity.

General Learning Outcome(s):

Collect, display, and analyze data to solve problems.

SPECIFIC LEARNING OUTCOME(S):	ACHIEVEMENT INDICATORS:
7.SP.3 Construct, label, and interpret circle graphs to solve problems. [C, CN, PS, R, T, V]	<ul style="list-style-type: none">→ Identify common attributes of circle graphs, such as<ul style="list-style-type: none">■ title, label, or legend■ the sum of the central angles is 360°■ the data is reported as a percent of the total and the sum of the percents is equal to 100%→ Create and label a circle graph, with or without technology, to display a set of data.→ Find and compare circle graphs in a variety of print and electronic media, such as newspapers, magazines, and the Internet.→ Translate percentages displayed in a circle graph into quantities to solve a problem.→ Interpret a circle graph to answer questions.

PRIOR KNOWLEDGE

Students may have had experience with the following:

- Differentiating between first-hand and second-hand data.
- Demonstrating an understanding of percent (limited to whole numbers) concretely, pictorially, and symbolically.
- Demonstrating an understanding of angles by
 - identifying examples of angles in the environment
 - classifying angles according to their measure
 - estimating the measure of angles using 45° , 90° , and 180° as reference angles
 - determining angle measures in degrees

- drawing and labelling angles when the measure is specified
- Selecting, justifying, and using appropriate methods of collecting data, including
 - questionnaires
 - experiments
 - databases
 - electronic media
- Graphing collected data and analyzing the graph to solve problems.
- Demonstrating an understanding of probability by
 - identifying all possible outcomes of a probability experiment
 - differentiating between experimental and theoretical probability
 - determining the theoretical probability of outcomes in a probability experiment
 - determining the experimental probability of outcomes in a probability experiment
 - comparing experimental results with the theoretical probability for an experiment

For more information on prior knowledge, refer to the following resource:

Manitoba Education and Advanced Learning. *Glance Across the Grades: Kindergarten to Grade 9 Mathematics*. Winnipeg, MB: Manitoba Education and Advanced Learning, 2015. Available online at www.edu.gov.mb.ca/k12/cur/math/glance_k-9/index.html.

RELATED KNOWLEDGE

Students should be introduced to the following:

- Solving problems involving percents from 1% to 100%.
- Demonstrating an understanding of circles by
 - describing the relationships among radius, diameter, and circumference of circles
 - relating circumference to pi
 - determining the sum of the central angles
 - constructing circles with a given radius or diameter
 - solving problems involving the radii, diameters, and circumferences of circles
- Expressing probabilities as ratios, fractions, and percents.
- Conducting a probability experiment to compare the theoretical probability (determined using a tree diagram, table, or another graphic organizer) and the experimental probability of two independent events.

BACKGROUND INFORMATION

The purpose of graphs is to display data. Students come to Grade 7 with experience in using line graphs to display continuous data, and bar graphs, double bar graphs, and pictographs to display discrete data. In Grade 7, students are introduced to circle graphs. Circle graphs are also referred to as pie charts.

Circle Graphs (Pie Charts)

Various media use circle graphs to display comparative data. The *circle graph* displays the distribution of data, not the actual data values. The set of data is grouped into categories, and each category is expressed as a percent of the whole set of data.

Each sector of the graph represents a part-to-whole ratio. Circle graphs emphasize the relation between a category and the whole set of data, as well as the relation between different categories within the data set. Comparisons within circle graphs are most clear when the number of categories is small and when there is a definite variation in the size of the categories.

Example:

Lunch Beverages Chosen by 325 Students at Svelton Middle School Cafeteria

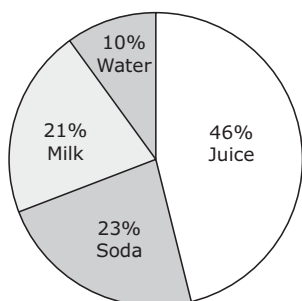

Data			
Beverage Choice	Number of Students	Percent	Angle Size
Juice	150	46%	166°
Soda	75	23%	83°
Milk	68	21%	75°
Water	32	10%	36°
Totals	325	100%	360°

This circle graph shows that nearly half of the students eating in the school cafeteria choose juice as a lunch beverage, and that nearly equal numbers of students choose milk or soda.

Circle graphs may also be used to compare data sets of different size, as circle graphs compare ratios rather than definite quantities. The ratios regarding students' choices of beverage in the example above can be compared to choices made by students in other schools or in other regions. The comparisons may be used to answer questions or to solve problems (e.g., which school to target for a nutrition education program).

Circle graphs are also used effectively to display probability.

Experience with circles and central angles (learning outcome 7.SS.1), an understanding of decimals, percents, and fractions, and the ability to perform calculations with these values (learning outcomes 7.N.2, 3, 4, 5, and 7) make it easier for students to create and interpret circle graphs. An understanding of rounding is useful when constructing circle graphs (e.g., if the majority of percents or angle sizes have been rounded up or down, adjustments may be required to ensure the sum of percents totals 100%, and central angles represented in the graph total 360°).

Ways to Create Circle Graphs

There are many ways to create circle graphs. Several of these are described below. Each circle graph must have a descriptive title and must be labelled with the category names and corresponding percents, or be accompanied by a legend. The percents represented by the sectors must total 100%, and the sum of the central angles must equal 360° .

- **Make concrete representations.**
 - Divide students into categories, such as those who have pets, and those who do not have pets. Ask students in each group to stand side by side, equidistant from each other, and then have the two groups form a circle. Estimate the middle of the circle, and draw a line (perhaps using a skipping rope) from the centre of the circle to each point where the two groups meet.
 - Students could also use tokens to represent the numbers in the two groups. The tokens could be evenly spaced around a circle whose circumference has been divided into percents, and a line could be drawn from the centre to the points on the circumference midway between adjacent groups.
- **Join bars from a bar graph.**
 - Create a bar to represent the quantity in each group.
 - Colour the bars.
 - Then cut out each bar, and join the bars end to end with tape to create one long strip. Bring the ends of the strip together to create a circle.
 - Draw a line from the centre of the circle to each point where a new category begins.
- **Use fraction circles.**
 - Choose a fraction circle that matches the number of pieces of data. For example, if there are 10 marbles in a set, choose a circle divided into tenths. Each tenth represents one marble. If six of the marbles are blue, colour $\frac{6}{10}$ of the circle blue; if three of the marbles are yellow, colour $\frac{3}{10}$ of the circle yellow; and if the remaining marble is red, colour $\frac{1}{10}$ of the circle red.
 - Draw lines from the centre of the circle to the point on the circumference where the categories meet.
- **Calculate percents and use percent circles.**

- Express the number in each category as a fraction of the whole set.
 - Convert each fraction to a decimal number and then to a percent.
 - Use a circle divided into 100ths, or into 20ths, to represent intervals of 5% (see BLM 5–8.26: Percent Circle).
 - Create sectors to represent the percent of each category.
- **Calculate percents and create central angles.**
- Create a chart such as the one below.

Category	Quantity	Fraction of the Whole	Percent of the Whole	Percent Times 360° in the Circle	Size of the Central Angle

- Draw a circle and one radius.
- Use the radius to measure one of the central angles.
- Use the subsequent radii to create successive central angles.

MATHEMATICAL LANGUAGE

angle
circle graph
key
legend
percent
pie chart
sectors
sum
sum of the central angles



Assessing Prior Knowledge

Materials:

- grid paper
- markers
- rulers
- access to data sources (optional)

Organization: Whole class, individual or pairs

Procedure:

1. Use a class discussion to review the characteristics of graphs, including the visual display of data, descriptive titles, labelling of axes, scale, and plots.
2. Ask students to work individually or in pairs to collect data on some topic, and then display the data as a graph. Students may obtain data through surveys or observations, or they may research a topic (e.g., colour of clothes worn on a given day, movie, music, reading, or food preferences, language(s) spoken, number of siblings, populations, life spans).
3. Ask students to write questions that can be answered using the information in their graphs, and then have them write answers to these questions.
4. Post students' graphs, along with the accompanying questions and answers, around the room.
5. Have students participate in a Gallery Walk to view the displayed graphs. As a class, discuss the purpose and effectiveness of using graphs to display information about a topic.

Variations:

- Supply students with data or prepared graphs, rather than having them collect their own data.
- Supply prepared graphs and related questions for students to answer. Then discuss the characteristics and purposes of graphs.

Observation Checklist

- Listen to and observe students' responses to determine whether students can do the following:
 - Select, justify, and use appropriate methods of collecting data, including questionnaires, experiments, databases, and electronic media.
 - Graph collected data and analyze the graph to solve problems.



Assessing Prior Knowledge

Materials:

- BLM 7.SP.3.1: Calculating the Percent of the Total
- index cards (optional)
- calculators (optional)

Organization: Individual or pairs, whole class

Procedure:

1. Review strategies for converting fractions to percents.
2. Distribute copies of BLM 7.SP.3.1: Calculating the Percent of the Total, and have students work individually or in pairs to find the percents presented in the scenarios.
3. When students have had sufficient time to respond to the questions, have them compare percents with a partner and resolve any discrepancies in their answers.
4. Reassemble as a class and discuss strategies students used to express portions of a whole as percents.

Variations:

- Have students create their own scenarios and questions regarding percents. Ask them to record the scenarios and questions on one side of an index card, and the solutions on the opposite side of the card. The cards may be used for drill games, learning activities, or Exit Slips.

Observation Checklist

- Listen to and observe students' responses to determine whether students can do the following:
 - Demonstrate an understanding of percent (limited to whole numbers) concretely, pictorially, and symbolically.



Assessing Prior Knowledge

Materials:

- BLM 7.SP.3.2: Percent of a Circle
- protractors
- calculators (optional)
- paper, compasses, and multi-sided number cubes or spinners (optional)

Organization: Individual, whole class

Procedure:

1. Review how to use a protractor to measure and draw angles.
2. Distribute copies of BLM 7.SP.3.2: Percent of a Circle, and have students, working individually, identify various percents of shaded circles, shade designated percents of circles, and draw angles to represent a percent of a circle.
3. Review and correct students' responses as a class, and discuss any questions that arise.

Variations:

- Provide students with additional practice in identifying various percents of shaded circles, shading various percents of circles, and drawing angles that correspond to a percent of a circle.
- Have students use an online computer game to identify the percent of a circle that has been shaded.

Sample Website:

Games are available on the following website:

Scweb4free.com. *Circle Graphs Game*. 2009.

www.scweb4free.com/circle.html.

In this game, students view segmented circles and select a multiple-choice response to identify the percent of students who prefer hamburgers.

- Have students play a game in pairs, using multi-sided number cubes, paper, a compass, and protractors. Each student uses the compass or template to draw a circle, mark its centre, and draw a radius from the centre to the outside of the circle. The partners take turns rolling the number cubes. The product of the two numbers rolled equals the percent of the circle to shade. The percent $\times 360^\circ$ indicates the size of angle to draw. Students shade each sector they draw. The first student to shade the entire circle wins.

Observation Checklist

- ☑ Listen to and observe students' responses to determine whether students can do the following:
 - ☐ Demonstrate an understanding of percent (limited to whole numbers) concretely, pictorially, and symbolically.
 - ☐ Demonstrate an understanding of angles by drawing and labelling angles when the measure is specified.

Suggestions for Instruction

- **Identify common attributes of circle graphs, such as**
 - **title, label, or legend**
 - **the sum of the central angles is 360°**
 - **the data is reported as a percent of the total and the sum of the percents is equal to 100%**
- **Create and label a circle graph, with or without technology, to display a set of data.**
- **Interpret a circle graph to answer questions.**

Materials:

- a large open area with a marked centre (e.g., the centre of a basketball court, the pitcher's mound of a ball diamond)
- long cords or skipping ropes (about four)
- tape or pegs to hold down one end of the cords
- grid paper
- markers
- scissors
- rulers
- demonstration board

Organization: Whole class, individual

Procedure:

Part A

1. As a class, review the concept that graphs are visual ways to display data. Inform students that for this learning activity they will use different methods to create a graph called a circle graph. The circle graph enables them to divide a group into different categories, and allows them to compare the size of each category to each other and to the whole group.
2. Secure one end of the cords to the centre of a circle in an open area.
3. Ask students to line up in two categories, such as those who have pets, and those who do not. Record the categories and numbers in each category.
4. Have the lines follow their leader to form a circle around the centre point.
5. Have one student from where the two lines meet go to the centre of the circle and bring the end of one of the cords back to the circumference of the circle. Note how the circle has been divided into two sections, those who have pets, and those who do not.
6. Talk about which sector is smaller, and which is larger. Discuss whether most of the students have pets or whether most do not. Estimate the percent of the circle represented by each category. Discuss a descriptive title for the circle graph.
7. Repeat the procedure with other categories (e.g., favourite colours, number of siblings, ethnic backgrounds). The four cords accommodate four categories.
8. Stop the exercise after sufficient examples have been explored, and review what students learned about circle graphs.
9. Post the categories and numbers in each category for each of the graphs formed in Part A.

Part B

10. Demonstrate creating a circle graph for one set of data by colouring grids to represent each category, cutting the coloured grids into strips, taping the strips end to end, and then joining the ends to form a circle. Trace the circle, estimate the centre of the circle, and mark a point of the circumference where different colours meet. Use a ruler to connect the centre of the circle and the points on the circumference. Estimate the percent of the circle represented by each sector, record the percent, and label the sector. Title the graph. Use the data to write comparative statements about the categories and the whole set of data represented by the graph.
11. Have students, working individually, select one data set and then create their own circle graph and comparative statements for that data set. Post students' graphs.

Variation:

- As an alternative to using the open area, solicit questions from the class, record the data on the demonstration board, and have pairs of students act out scenarios using counters and circles (as described in the Background Information for learning outcome 7.SP.3).



Observation Checklist

- Listen to and observe students' responses to determine whether students can do the following:
 - Identify common attributes of circle graphs, such as
 - title, label, or legend
 - the sum of the central angles is 360°
 - the data is reported as a percent of the total and the sum of the percents is equal to 100%
 - Create and label a circle graph, with or without technology, to display a set of data.
 - Interpret a circle graph to answer questions.

Suggestions for Instruction

- **Identify common attributes of circle graphs, such as**
 - title, label, or legend
 - the sum of the central angles is 360°
 - the data is reported as a percent of the total and the sum of the percents is equal to 100%
- **Create and label a circle graph, with or without technology, to display a set of data.**
- **Interpret a circle graph to answer questions.**

Materials:

- BLM 7.SP.3.3: Data Chart for Creating Circle Graphs
- BLM 5–8.26: Percent Circle
- fraction circles, available on the following website:
Manitoba Education. "Middle Years Activities and Games." *Mathematics*.
www.edu.gov.mb.ca/k12/cur/math/my_games/index.html
- coloured counters (e.g., marbles, cubes, toy cars, or toy animals, in bags)
- markers or pencil crayons
- compasses

Organization: Whole class, individual or pairs

Procedure:

This learning experience will likely take more than one class and is divided into three parts. Use the same materials to create three graphs in Parts A to C.

Part A

1. As a class, review the characteristics and purposes of circle graphs.
2. Distribute fraction circles that have been divided into 10ths.
3. Have students, working individually or in pairs, randomly choose 10 items (or the number of divisions on the fraction circles) from a bag. Then ask students to do the following:
 - a) Sort the items according to colour.
 - b) Colour adjacent segments on a fraction circle to match the number of items of each colour.
 - c) Draw bold lines to divide the colours and create sectors of each colour.
4. Ask students to label each sector with the applicable colour and the corresponding percent, or create a legend for the categories (e.g., if 6 of the 10 cubes selected were blue, then $\frac{6}{10}$ or 60% of the cubes were blue).
5. Have students write a title for their graph, as well as comparative statements relating to the graph.
6. Have students total the percents represented in each section of their graph, and record the totals. Ask students to make a general statement regarding the sum of the percents in each graph. Discuss why the sum is 100%. In the discussion, include the concept that each category is a part of the whole set and 100% represents the whole set.

Part B

7. Distribute copies of
 - BLM 7.SP.3.3: Data Chart for Creating Circle Graphs
 - fraction circles that have been divided into 20ths or 100ths (see BLM 5–8.26: Percent Circle)
8. Have students randomly select 5 to 30 coloured counters and sort them into colour groups. Students then complete the following process, using BLM 7.SP.3.3: Data Chart for Creating Circle Graphs:
 - a) Record the colours in the Category column of the chart.
 - b) Record the number of counters of each colour in the Quantity column.
 - c) Calculate the total quantity.
 - d) Write the quantity of each colour as a fraction of the total counters selected.
 - e) Then convert that fraction to a percent.

- f) Add the percents. If it was necessary to round some of the percents, it is possible that they will not total 100%. If they do not total 100%, determine which percents were rounded up and which were rounded down and make adjustments to the most appropriate values. (The final two columns of the chart will be completed in Part C.)
9. Ask students to use the percents to create a circle graph using the percent circles. Each 100th mark represents 1% of the circle, or each 20th represents 5% of the circle.
10. Have students label the graph, including
 - a) a title for the graph
 - b) a label for each category (if there is insufficient room, a legend may be used instead of labels)
 - c) the percent of the whole for each category
11. Have students write comparative statements related to the categories of the graph.

Part C

12. As a class, review how to use a protractor and how to draw angles of specific measures.
13. Demonstrate to students that
 - each sector of the circle represents an angle measure
 - there are 360° in a circle
14. Show students how to find the angle measure by finding a percent of 360° .
15. Have students calculate the angle measures and record them on BLM 7.SP.3.3: Data Chart for Creating Circle Graphs. Some of the angle measures may need to be rounded. When the angle measures are totalled, they may not equal 360° . If this is the case, review the rounding, and adjust the values up or down as necessary.
16. Ask students to draw a circle graph using the measures of the central angles for each category.
 - a) Use a compass to draw a circle.
 - b) Mark the middle of the circle.
 - c) Draw one radius for the circle.
 - d) Use the radius as a starting point to measure one angle.
 - e) Use subsequent radii to create successive central angles.
17. Have students label the graph, including
 - a) a title for the graph
 - b) a label for each category (if there is insufficient room, a legend may be used instead of labels)
 - c) the percent of the whole for each category
18. Have students write comparative statements related to the categories of the graph.
19. As a class, discuss the applications for using each method of creating a circle graph.

Variations:

- Supply data for each graph, rather than having students generate their own data.
- Have students use previously collected data, or collect their own data, to create circle graphs, using BLM 7.SP.3.3: Data Chart for Creating Circle Graphs (optional).
- Use technology to create circle graphs. For example, use graphing programs such as Graphical Analysis, spreadsheet programs such as Excel or Numbers, or online graphing programs.

Sample Websites:

Graphing programs are available on websites such as the following:

Math Playground. "Circle Graphs." *Math Manipulatives*. 2010.

www.mathplayground.com/piechart.html.

U.S. Department of Education. Institute of Education Sciences, National Center for Education Statistics. "Create a Graph." *Kids' Zone, Learning with NCES*.

<http://nces.ed.gov/nceskids/createagraph/>.

Utah State University. "Data Analysis and Probability." *National Library of Virtual Manipulatives*. 1999–2010. http://nlvm.usu.edu/en/nav/topic_t_5.html.



Observation Checklist

- Listen to and observe students' responses to determine whether students can do the following:
 - Identify common attributes of circle graphs, such as
 - title, label, or legend
 - the sum of the central angles is 360°
 - the data is reported as a percent of the total and the sum of the percents is equal to 100%
 - Create and label a circle graph, with or without technology, to display a set of data.
 - Interpret a circle graph to answer questions.

Suggestions for Instruction

- **Identify common attributes of circle graphs, such as**
 - title, label, or legend
 - the sum of the central angles is 360°
 - the data is reported as a percent of the total and the sum of the percents is equal to 100%
- **Find and compare circle graphs in a variety of print and electronic media, such as newspapers, magazines, and the Internet.**
- **Translate percentages displayed in a circle graph into quantities to solve a problem.**
- **Interpret a circle graph to answer questions.**

Materials:

- BLM 7.SP.3.4: Comparing Examples of Circle Graphs
- BLM 7.SP.3.5: Translating Percentages in a Circle Graph into Quantities
- media sources (e.g., magazines, newspapers, advertisements, the Internet) for examples of circle graphs
- scissors
- glue or tape

Organization: Small groups

Procedure:

Part A

1. Divide the class into small groups. Have the students in each group search through various media sources to find five examples of circle graphs. Have them print or cut out the graphs, including any titles, legends, or captions that accompany the graphs.
2. Ask each group to analyze their selected graphs to determine whether or not each graph includes the common attributes of circle graphs.
3. Group members can take turns recording information about each graph on the chart provided on BLM 7.SP.3.4: Comparing Examples of Circle Graphs.
4. Have the groups analyze their graphs and pose two or three questions that can be answered using information from their graphs. They record their questions on the first page of BLM 7.SP.3.5: Translating Percentages in a Circle Graph into Quantities. Students then prepare answers to their questions and record them on the second page of the BLM.

Part B

5. Present to the class a graph prepared by one of the groups. Demonstrate how the percentages in the graph could be used to solve a problem.

Example:

A graph about teenage music preferences shows the percentage of students who prefer different musical artists. A music store catering to teenagers could use this information to choose which products to stock in its store. If 62% of the students prefer artist B, and the store is spending \$9500 on inventory this month, how much money should the store spend purchasing artist B's music?

6. Have students work together to prepare problems that could be solved using their graphs. Ask them to record the problems on the first page of BLM 7.SP.3.5: Translating Percentages in a Circle Graph into Quantities. Have students prepare solutions to their problems and record them on the second page of the BLM.
7. Post the completed pages for a Gallery Walk. Have students solve their classmates' problems and verify their solutions.



Observation Checklist

- Listen to and observe students' responses to determine whether students can do the following:
 - Identify common attributes of circle graphs, such as
 - title, label, or legend
 - the sum of the central angles is 360°
 - the data is reported as a percent of the total and the sum of the percents is equal to 100%
 - Find and compare circle graphs in a variety of print and electronic media, such as newspapers, magazines, and the Internet.
 - Translate percentages displayed in a circle graph into quantities to solve a problem.
 - Interpret a circle graph to answer questions.

Suggestions for Instruction

- **Create and label a circle graph, with or without technology, to display a set of data.**
- **Translate percentages displayed in a circle graph into quantities to solve a problem.**

Materials:

- BLM 5–8.26: Percent Circle
- fraction circles, available on the following website:
Manitoba Education. “Middle Years Activities and Games.” *Mathematics*.
www.edu.gov.mb.ca/k12/cur/math/my_games/index.html.
- a variety of packages (of various sizes) containing coloured items (e.g., coloured beads, candy)
- compasses
- protractors
- BLM 7.SP.3.3: Data Chart for Creating Circle Graphs (optional)

Organization: Small groups

Procedure:

1. Have students, working in small groups, sort the contents of the supplied packages into various colours and use the information to create a circle graph. Students may use BLM 7.SP.3.3: Data Chart for Creating Circle Graphs to help organize their answers. They may create their graph with a compass and a protractor, or using fraction circles or percent circles provided.
2. Have students propose a question to be solved using the information from their graph. For example, if we buy 2000 candies, how many can we expect to be red?
3. Ask each group to exchange their graph with that of another group, and solve the new problem.
4. After solving the problem, students return it to its originators and discuss any discrepancies.



Observation Checklist

- Listen to and observe students' responses to determine whether students can do the following:
 - Create and label a circle graph, with or without technology, to display a set of data.
 - Translate percentages displayed in a circle graph into quantities to solve a problem.

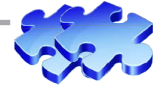

Geometric Flags

Introduction:

Students use information from a group survey to create a flag representative of the group. Then they calculate the area of the spaces in the flag.

Purpose:

In this investigation, students will demonstrate the ability to do the following (connections to learning outcomes are identified in parentheses):

- Solve problems involving percents. (7.N.3)
- Construct circle graphs to solve problems. (7.SP.3)
- Perform geometric constructions, including parallel and perpendicular line segments and perpendicular and angle bisectors. (7.SS.3)
- Perform and describe transformations. (7.SS.5)
- Apply a formula for determining the area of triangles, parallelograms, and circles. (7.SS.2)

Students will also demonstrate the following mathematical processes:

- Communication
- Mental Mathematics and Estimation
- Problem Solving
- Reasoning
- Technology

Materials/Resources:

- ruler
- compass
- protractor
- right triangle
- coordinate grid
- paper (for the flags)
- art supplies
- calculator (optional)
- Mira (optional)
- tracing paper (optional)

Organization: Small groups, individual

Procedure:*Student Directions*

1. Survey a group of people regarding their preferred colour. You may survey groups within your class, in different classes, in your family, and so on. If each person in the group chooses a different colour, you may wish to have the survey participants select from a list of three to five colours. You may have them rank the colours as first, second, and third choice.
2. Calculate the percent of the group that prefers each colour.
3. Construct a circle graph to represent the preferences.
4. Design a flag for the group using the group's preferred colours.
 - a) Calculate the area of the flag to be covered with each preferred colour.
 - b) Create your design using circles, triangles, parallelograms, and transformations. Include parallel and perpendicular line segments and perpendicular and angle bisectors.
 - c) Adjust the size of each shape to match the area to be covered with each preferred colour.
5. Create a summary chart that shows the areas of the different shapes in each preferred colour, including
 - a) the total area representing each colour
 - b) the percent of the total area covered by each colour
 - c) a circle graph that represents the percent of the area covered by each colour
6. Create a final copy of your flag.
7. Prepare a presentation about your flag. In the presentation, prove that your flag represents the group findings because the area covered by each colour in the flag is the same as the percent of the group that preferred each colour. Highlight some features of your flag and how you solved a problem in creating the flag.



Observation Checklist

- Listen to and observe students' responses to determine whether students can do the following:
 - Calculate percents.
 - Construct circle graphs.
 - Estimate and calculate areas of triangles, parallelograms, and circles.
 - Solve a problem involving the percent of an area.
 - Perform and describe a transformation in the flag.
 - Construct and identify parallel and perpendicular line segments in the flag.
 - Construct and identify perpendicular and angle bisectors in the flag.
 - Communicate mathematical ideas effectively.

Statistics and Probability (Chance and Uncertainty) (7.SP.4, 7.SP.5, 7.SP.6)

Enduring Understanding(s):

Percents, fractions, decimals, and ratios are different representations of the same quantity.

The principles of the probability of a single event apply to the probability of independent events.

General Learning Outcome(s):

Use experimental or theoretical probabilities to represent and solve problems involving uncertainty.

SPECIFIC LEARNING OUTCOME(S):	ACHIEVEMENT INDICATORS:
<p>7.SP.4 Express probabilities as ratios, fractions, and percents. [C, CN, R, T, V]</p>	<ul style="list-style-type: none"> → Determine the probability of an outcome occurring for a probability experiment, and express it as a ratio, fraction, or percent. → Provide an example of an event with a probability of 0 or 0% (impossible) and an event with a probability of 1 or 100% (certain).
<p>7.SP.5 Identify the sample space (where the combined sample space has 36 or fewer elements) for a probability experiment involving two independent events. [C, ME, PS]</p>	<ul style="list-style-type: none"> → Provide an example of two independent events, such as <ul style="list-style-type: none"> ■ spinning a four-section spinner and an eight-sided die ■ tossing a coin and rolling a twelve-sided die ■ tossing two coins ■ rolling two dice and explain why they are independent. → Identify the sample space (all possible outcomes) for an experiment involving two independent events using a tree diagram, a table, or another graphic organizer.

(continued)

SPECIFIC LEARNING OUTCOME(S):	ACHIEVEMENT INDICATORS:
<p>7.SP.6 Conduct a probability experiment to compare the theoretical probability (determined using a tree diagram, a table, or another graphic organizer) and experimental probability of two independent events. [C, PS, R, T]</p>	<ul style="list-style-type: none"> → Determine the theoretical probability of an outcome for an experiment involving two independent events. → Conduct a probability experiment for an outcome involving two independent events, with or without technology, to compare the experimental probability to the theoretical probability. → Solve a probability problem involving two independent events.

PRIOR KNOWLEDGE

Students may have had experience with the following:

- Demonstrating an understanding of fractions less than or equal to one by using concrete and pictorial representations to
 - name and record fractions for the parts of a whole or a set
 - compare and order fractions
 - model and explain that for different wholes, two identical fractions may not represent the same quantity
 - provide examples of where fractions are used
- Describing and representing decimals (tenths and hundredths) concretely, pictorially, and symbolically.
- Demonstrating an understanding of fractions by using concrete and pictorial representations to
 - create sets of equivalent fractions
 - compare fractions with like and unlike denominators
- Describing and representing decimals (tenths, hundredths, thousandths) concretely, pictorially, and symbolically.
- Relating decimals to fractions (tenths, hundredths, thousandths).
- Comparing and ordering decimals (tenths, hundredths, thousandths) by using
 - benchmarks
 - place value
 - equivalent decimals

- Describing the likelihood of a single outcome occurring, using words such as
 - impossible
 - possible
 - certain
- Comparing the likelihood of two possible outcomes occurring, using words such as
 - less likely
 - equally likely
 - more likely
- Demonstrating an understanding of ratio, concretely, pictorially, and symbolically.
- Demonstrating an understanding of percent (limited to whole numbers) concretely, pictorially, and symbolically.
- Demonstrating an understanding of multiplication and division of decimals involving
 - 1-digit whole-number multipliers
 - 1-digit natural number divisors
 - multipliers and divisors that are multiples of 10
- Demonstrating an understanding of probability by
 - identifying all possible outcomes of a probability experiment
 - differentiating between experimental and theoretical probability
 - determining the theoretical probability of outcomes in a probability experiment
 - determining the experimental probability of outcomes in a probability experiment
 - comparing experimental results with the theoretical probability for an experiment

For more information on prior knowledge, refer to the following resource:

Manitoba Education and Advanced Learning. *Glance Across the Grades: Kindergarten to Grade 9 Mathematics*. Winnipeg, MB: Manitoba Education and Advanced Learning, 2015. Available online at www.edu.gov.mb.ca/k12/cur/math/glance_k-9/index.html.

RELATED KNOWLEDGE

Students should be introduced to the following:

- Solving problems involving percents from 1% to 100%.
- Demonstrating an understanding of the relationship between repeating decimals and fractions, and terminating decimals and fractions.

- Comparing and ordering fractions, decimals (to thousandths), and integers by using
 - benchmarks
 - place value
 - equivalent fractions and/or decimals
- Demonstrating an understanding of central tendency and range by
 - determining the measures of central tendency (mean, median, mode) and range
 - determining the most appropriate measures of central tendency to report findings
- Determining the effect on the mean, median, and mode when an outlier is included in a data set.
- Constructing, labelling, and interpreting circle graphs to solve problems.

Note:

When working with the probability of two independent events, keep in mind that Grade 7 students have not yet had exposure to multiplication of fractions, but may have had exposure to multiplication of decimals.

BACKGROUND INFORMATION

In our society, probability is used in making weather forecasts to express the likelihood of precipitation, in making medical inferences such as the likelihood of contracting an infection or a disease, in making correlations between lifestyle habits and health, in predicting election results, in determining the chances of winning a lottery or a draw, in understanding whether or not a game is fair, and so on.

The study of probability begins in Grade 5, with students describing the likelihood of a single event occurring and comparing the likelihood of two possible outcomes using the language of probability. Unless an event is the only possible outcome, or unless it is impossible for an outcome to occur, one can never be certain of an outcome, or of the number of times an outcome will occur in a given number of trials. Thus, in Grade 6, students determine and compare theoretical probability and experimental results.

Experimental Probability

Experimental probability describes what actually did happen in a real situation. Sometimes experimental probability is called *relative frequency*.

$$\text{Experimental Probability of an Event} = \frac{\text{Number of Observed Favourable Outcomes}^*}{\text{Total Number of Trials}}$$

*A favourable outcome is the outcome that the experimenter is looking for.

If, for example, an experimenter was examining the probability of rolling a 4 when rolling a regular number cube, and rolled the number cube 50 times, and 10 of those times he or she rolled 4s, the experimental probability would be $\frac{10}{50}$ or $\frac{1}{5}$ or 0.2 or 20%.

Probability is a generalized statement used to predict future events. A generalization cannot be trusted for making predictions if it is based on a small number of trials; however, students can increase the number of trials in their experiments by combining trials conducted by different students, or by using computer applets for generating large numbers of number cube rolls, coin tosses, or spins.

Sample Websites:

Some applets are available on the following websites:

Shodor. "Experimental Probability." *Interactive*. 1994–2011.

www.shodor.org/interactivate/activities/ExpProbability/.

Select the spinner, or the type of die, and the number of trials desired. The simulator tallies and calculates results.

Utah State University. "Data Analysis and Probability." *National Library of Virtual Manipulatives*. 1999–2010. http://nlvm.usu.edu/en/nav/topic_t_5.html.

In the Grades 6 to 8 section, select Coin Tossing or Spinners.

A larger number of trials will permit students to make a generalization in which they can have confidence. The larger the sample size is, the more similar the experimental results and the theoretical probability will be.

Theoretical Probability

Theoretical probability helps students to predict what is likely to happen in a given circumstance, but does not foretell what will happen for sure. To calculate the theoretical probability of an event, the events must occur randomly, not influenced by any outside force, and the events must be equally likely, or have the same chance of occurring.

$$\text{Theoretical Probability of an Event} = \frac{\text{Number of Outcomes Favourable}^* \text{ to the Event}}{\text{Total Number of Possible Equally Likely Outcomes}}$$

*A favourable outcome is the desired outcome.

If, for example, an experimenter was examining the probability of rolling a 4 when rolling a regular number cube, he or she would know the number of favourable outcomes is 1, and the number of equally likely outcomes is 6, so the probability is $\frac{1}{6}$ or 0.16 or 16.6%.

Theoretical probability may be used to make predictions about future events, when events are equally likely. If the events are not equally likely, as when tossing an object and predicting whether it will land right-side up, upside down, or on its side, *experimental probability* may be used to make future predictions.

In Grade 7, students express probability as ratios, fractions, or percents. Probability ranges between impossible 0% and certain 100% (between $\frac{0}{1}$ and $\frac{1}{1}$ or between 0 and 1). A probability line with benchmarks may be used to illustrate the equivalent expressions.

Example:

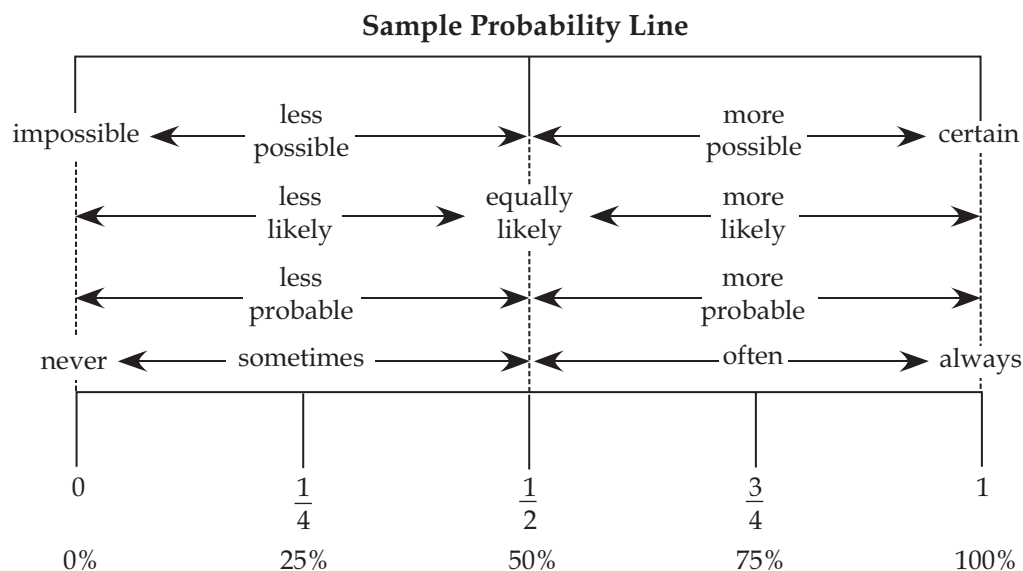

$$P = \frac{\text{Number of Favourable Outcomes}}{\text{Number of Possible Outcomes}}$$

Probability Investigations and Problems

Grade 7 students extend investigations of theoretical and experimental probability to include two independent events. They also solve probability problems involving two independent events.

To investigate probability with experiments, students will need access to devices that generate random results. These may include spinners, items to toss (e.g., coins, bicoloured tiles, number cubes, tacks), and items to draw from (e.g., cards from a deck, coloured blocks, tiles, marbles from a bag). Computer-simulated applets may also be used.

Sometimes probability problems involve situations that may be too dangerous, too expensive, or too difficult to experiment with. In these circumstances, a simulation can be chosen to mimic the experiment. For example, in a situation that requires investigating the possibility of whether a birth is male or female, the two outcomes can be represented with the two sides of a coin.

Organizing Outcomes of Probability Investigations

Students may begin studying the probability of two independent events with a concrete investigation, such as predicting the outcome of tossing two coins. The obvious outcomes are two heads, two tails, and one of each. Some students may conclude that there is a likelihood of $\frac{1}{3}$ for each combination. An investigation will generate different results, and the difference may interest students in organizing possible outcomes in a systematic way.

Outcomes of probability investigations can be organized with the use of a tree diagram and a frequency table or chart:

- Tree Diagram:** A *tree diagram* lists the *possible outcomes* for each event in two columns and connects them with lines to form branches. The first column (or row) lists all possible outcomes for the first event. The second column (or row) lists all outcomes for the second event beside each of the outcomes in the first event. A tree diagram is used to describe theoretical probability.

Example:

Below is an example of a horizontal tree diagram of the possible outcomes for the independent events when tossing two coins.

Tree Diagram for Tossing Coins

Possible Outcomes for Tossing First Coin	Outcomes for Tossing Second Coin	All Possible Outcomes	Probabilities
H	H	(H, H)	$P_{(H, H)} = \frac{1}{4} = 25\%$
	T	(H, T)	$P_{(1H, 1T)*} = \frac{2}{4} = 50\%$
T	H	(T, H)	*assuming order does not matter
	T	(T, T)	$P_{(T, T)} = \frac{1}{4} = 25\%$

The Probability of Any Event = $\frac{\text{Number of Favourable Outcomes}}{\text{Number of Possible Outcomes}}$

$$\text{e.g., } P_{(T, T)} = \frac{1}{4}$$

Note that the probabilities for the three outcomes listed above are not $\frac{1}{3}$ each, but rather $\frac{1}{4}$, $\frac{1}{4}$, and $\frac{1}{2}$ respectively.

- **Frequency table or chart:** When used to predict possible outcomes of an event, a *frequency table* or *chart* organizes all possible outcomes for two independent events. Each cell in the table indicates one possible outcome.

Example:

		First Coin Toss	
		H	T
Second Coin Toss	H	H, H	T, H
	T	H, T	T, T

The Probability of Any Event = $\frac{\text{Number of Favourable Outcomes}}{\text{Number of Possible Outcomes}}$

$$\text{e.g., } P_{(1H, 1T)^*} = \frac{2}{4} = 50\% \quad * \text{ assuming order does not matter}$$

Organizing outcomes helps to reveal hidden outcomes, as in the examples above, where students may erroneously believe there are only three possible outcomes: 2 heads, 2 tails, and one of each.

To demonstrate a thorough understanding of probability, students should recognize the following:

- Outcomes must be equally likely. For example, a spinner that is $\frac{1}{2}$ red, $\frac{1}{4}$ yellow, and $\frac{1}{4}$ blue has $\frac{2}{4}$ possibilities for red.
- The probability of an outcome is equivalent when tossing the same number cube six times or when tossing six number cubes one time each. Or, if there are six red marbles and six white marbles in a bag, the chance of pulling either colour is the same as if there is one red marble and one white marble in the bag.
- For independent events, the probability of an outcome does not change based on the previous outcome. When an event such as rolling a sum of 7 on two number cubes has repeated itself several times, there is no increased likelihood that the next roll will or will not be a sum of 7. The likelihood of rolling or not rolling a sum of 7 remains the same, regardless of the outcome in the previous roll.
- Knowing the vocabulary terms is important. For example, *likely* means more than 50% of the time, not almost all the time.

MATHEMATICAL LANGUAGE

certain event
dependent event
event
experimental probability
favourable outcome
frequency table or chart
impossible event
independent event
likely
outcome
possible outcome
probability
random
relative frequency
sample size
sample space
theoretical probability
tree diagram



Assessing Prior Knowledge

Materials:

- a set of two multi-sided number cubes or spinners per group
- calculators (optional)
- BLM 7.SP.4.1: Recording Sheet for Fraction–Decimal–Percent Equivalents (optional)
- paper (optional)

Organization: Whole class, small groups (of three or five)

Procedure:

1. As a class, review writing equivalent fractions, decimals, and percents.
2. Organize the class into groups, and have each group designate a Person A, B, and C.
3. Demonstrate a few rounds of the game using three volunteers. The aim is to move as quickly and accurately as possible to create 10 equivalent fractions, decimals, and percents, using the following routine:
 - a) **Person A:** Roll two number cubes.
 - b) **Person B:** Use the numbers on the number cube to create a proper fraction.
 - c) **Person C:** Express the fraction as an equivalent decimal number.
 - d) **Person A:** Express the number as an equivalent percent.
 - e) **Person B:** Roll two number cubes. The routine continues.
 - f) Use BLM 7.SP.4.1: Recording Sheet for Fraction–Decimal–Percent Equivalents to record results. Person A begins the sheet after rolling the number cube. Person A records what Person B says, and then passes the sheet to Person B. Person B records what person C says, and passes the sheet to person C. The routine continues, with the sheet following behind the person who is answering.
4. Groups carry on with the game, racing to see who can be the first group to create 10 equivalent fractions, decimals, and percents correctly.
5. Play as many rounds as seems interesting and useful.

Variation:

- Play the game as a baseball game. The pitcher “pitches” two numbers. The batter gets to first base by naming the proper fraction, to second base by naming the decimal, and to third base by naming the percent. By finishing within a time limit, the batter gets to home base and earns a run. Failure to respond in a given time results in an out. The game can be played as a whole class or in pairs, using a paper baseball diamond and markers.

Observation Checklist

- Listen to and observe students’ responses to determine whether students can do the following:
 - Name part-to-whole ratios as fractions and their decimal and percent equivalents.

Suggestions for Instruction

- **Determine the probability of an outcome occurring for a probability experiment, and express it as a ratio, fraction, or percent.**
- **Provide an example of an event with a probability of 0 or 0% (impossible) and an event with a probability of 1 or 100% (certain).**

Materials:

- BLM 7.SP.4.2: What Is the Probability?
- a bag of letter tiles (B, R, I, D, G, E) (optional)

Organization: Individual, whole class

Procedure:

1. Distribute copies of BLM 7.SP.4.2: What Is the Probability?
2. Have students answer the questions on the sheet on their own. The questions require students to
 - a) identify outcomes and probabilities
 - b) compare experimental and theoretical probability
 - c) identify outcomes as impossible, certain, or more likely
 - d) create and answer their own question related to probability
3. Reassemble as a class and have students share their responses to the questions, correcting any errors.

Variations:

- As a class, complete BLM 7.SP.4.2: What Is the Probability? and discuss any questions students may have.
- Have students work in small groups. Provide each group with the bag of letter tiles (B, R, I, D, G, E), and have them investigate the probability of drawing each letter in 36 trials. Combine the results of the small groups, recalculate the experimental probability, and compare the probability for the combined results to the results of the individual groups.
- Ask students to discuss why the experimental results and the theoretical probability are different from each other.
- Have students, working in pairs, choose their own letter tiles (or other devices) and prepare a similar question sheet and answer key. Groups exchange sheets, complete and correct the questions, and resolve any discrepancies between the responses.
- Have students design spinners, or situations, that would result in given probabilities.



Observation Checklist

- Listen to and observe students' responses to determine whether students can do the following:
 - Describe single events as impossible, possible, certain, less likely, more likely, or equally likely.
 - Identify possible outcomes in a probability scenario.
 - Differentiate between experimental and theoretical probability.
 - Determine theoretical and experimental probability.
 - Compare experimental results with theoretical probability.

Suggestions for Instruction

- **Determine the probability of an outcome occurring for a probability experiment, and express it as a ratio, fraction, or percent.**
- **Provide an example of an event with a probability of 0 or 0% (impossible) and an event with a probability of 1 or 100% (certain).**

Materials:

One set per pair of students:

- six-sided pencils
- notebooks
- markers
- BLM 7.SP.4.3: Experimental Probability Tally Sheet and Probability of Outcomes (optional)

Organization: Pairs, whole class

Procedure:

1. Have students, working in pairs, mark each side of a six-sided pencil with one possible outcome (e.g., numbers, student names, letters to form a word).
2. Students conduct their probability experiment, proceeding as follows:
 - a) One student rolls the pencil by rubbing it between his or her palms, and then lays a hand on a notebook (to muffle the sound) and allows the pencil to roll down the hand onto the notebook.
 - b) The student announces the outcome that landed facing up.
 - c) The other student records the result on a tally sheet.
 - d) Students continue rolling and recording until they have completed a set number of rolls, or until a set time has passed.
3. Students total their tally marks, and record the ratios of tallies for each outcome to the total number of tallies (outcome : total).
4. Students then record the probability for each outcome, expressing it as a fraction, a decimal, and a percent.
5. When groups have completed their experiment, reassemble as a class and ask students what they have discovered or learned from the experience.
 - a) Compare the probabilities obtained by different groups. If students have used the same outcomes, consolidate the group data and calculate the probability for the combined results.
 - b) Students may note the sum of the values in the decimal column totals about 1 (depending on rounding), and the sum of the percents is close to 100% (depending on rounding).

- c) Ask students for an example of an outcome that is impossible for this experiment, and for an event that is certain.

Variations:

- Have all students mark their six-sided pencils with the same outcomes, and combine the class results to represent a larger trial.
- Events that are not equally likely, such as a paper cup landing upright, upside down, or on its side, may be used for this experiment.
- Compare students' results and discuss differences observed.



Observation Checklist

- Listen to and observe students' responses to determine whether students can do the following:
 - Determine the probability of an outcome occurring for a probability experiment, and express it as a ratio, fraction, or percent.
 - Provide an example of an event with a probability of 0 or 0% (impossible) and an event with a probability of 1 or 100% (certain).

Suggestions for Instruction

- **Provide an example of an event with a probability of 0 or 0% (impossible) and an event with a probability of 1 or 100% (certain).**

Materials:

- rulers (30 cm)
- two colours of pens or highlighters
- demonstration board

Organization: Whole class, pairs

Procedure:

1. Remind students that probability is used to predict the likelihood that an event will happen. Ask whether it is possible to predict any event with certainty.

Answer:

The only events that can be predicted with certainty are those with probabilities of 0% or 100%.

2. Ask students for examples of events with a probability of 0% (impossible) or 100% (certain).

Example:

If a draw box contains only odd numbers, the probability of drawing an even number is 0% and the probability of drawing an odd number is 100%.

3. Have students create a probability line similar to the Sample Probability Line illustrated in the Background Information.

Have students include some or all of the following vocabulary in their probability line:

- impossible, less possible, more possible, certain
 - less likely, equally likely, more likely
 - less probable, more probable
 - never, sometimes, often, always
4. Have pairs of students challenge one another by describing situations that could match the probability of a point or region on the probability line.

Example:

- Student A describes a situation, and asks for an event that would match a probability descriptor: Given a bag containing the letters of the alphabet, identify an event that would be less likely than another event.
- Student B replies: Given a bag containing the letters of the alphabet, it is less likely you'll draw a vowel than a consonant.
- Student B then challenges Student A, and may ask for an impossible event in the same situation.
- Student A could reply: Given the letters of the alphabet, it is impossible to draw a number.

Variations:

- Provide a template of a probability line with benchmarks, directional arrows, and blanks for students to fill in.
- As an extension, have students identify situations with events that have a 50% probability (or other value) of occurring.



Observation Checklist

- Listen to and observe students' responses to determine whether students can do the following:
 - Provide an example of an event with a probability of 0 or 0% (impossible) and an event with a probability of 1 or 100% (certain).

Suggestions for Instruction

- **Provide an example of two independent events, such as**
 - **spinning a four-section spinner and an eight-sided die**
 - **tossing a coin and rolling a twelve-sided die**
 - **tossing two coins**
 - **rolling two dice****and explain why they are independent.**

Materials:

- BLM 7.SP.5.1: Which Conditions Affect Probability?
- coins
- colour counters
- bags
- ticket stubs with numbers (optional)
- BLM 7.SP.5.2: Examples of Two Independent Events (optional)

Organization: Small groups (of three or four students), whole class

Procedure:

1. Divide students into small groups.
2. Distribute copies of BLM 7.SP.5.1: Which Conditions Affect Probability?
3. Have each group determine the theoretical probability of each event occurring, decide whether specified conditions affect the theoretical probability of the event, and explain why or why not.
4. Reassemble as a class and discuss students' responses. Probability is based on the number of favourable outcomes and the number of possible outcomes. Only conditions that alter the number of outcomes (e.g., adding an extra item, not replacing an item that has been removed) will affect the theoretical probability of an event.

5. Inform students of the following:
 - a) When one event does not affect the probability of an outcome of another event, the events are said to be *independent events*. Ask students to identify the independent events in the examples on BLM 7.SP.5.1.
 - b) When one event does affect the probability of an outcome of another event, the events are said to be *dependent events*. Ask students to identify the dependent events in the examples on BLM 7.SP.5.1. Have students identify other events that would not represent independent events.
6. Ask students whether rolling a number cube before pulling a coloured block from a bag will have any effect on the colour of the block drawn.
7. Have students return to their small groups and list pairs of independent events, explaining why the two events are independent. Ask them to list some pairs of events that are not representative of independent events.

Examples:

Independent events could include

- choosing a card from a deck (or a marble, other counter, number, or letter tile from a bag), returning it to the deck (or bag), and drawing a second item
- tossing two coins, number cubes, or letter cubes
- randomly choosing two items (e.g., names, numbers, menu items, clothing selections, colours, movies, transportation methods, vacation spots, games) from a selection (The first choice must not be removed from the set, for the events to remain independent.)
- any combination of the above items

Variations:

- Provide concrete opportunities for students to experiment with determining whether or not probability is affected by certain conditions. For example, collect tickets or names on slips and conduct a draw to determine the probability of a particular winner. Conduct the experiment, first replacing a name each time it is drawn, and then not replacing a name after it has been drawn.
- Provide a chart (such as BLM 7.SP.5.2: Examples of Two Independent Events) for students to list sets of two independent events and to explain why the events are independent.
- Provide students with a list of pairs of events and ask them to identify whether or not the pairs represent independent events, and to explain why the events are or are not independent.



Observation Checklist

- ☑ Listen to and observe students' responses to determine whether students can do the following:
 - ☐ Provide an example of two independent events, such as
 - spinning a four-section spinner and an eight-sided die
 - tossing a coin and rolling a twelve-sided die
 - tossing two coins
 - rolling two dice
- and explain why they are independent.

Suggestions for Instruction

- **Identify the sample space (all possible outcomes) for an experiment involving two independent events using a tree diagram, a table, or another graphic organizer.**

Materials:

- coins (the same or different denominations)
- demonstration board
- math journals
- BLM 7.SP.4.3: Experimental Probability Tally Sheet and Probability of Outcomes (optional)

Organization: Pairs or small groups, whole class, individual

Procedure:

1. Make preparations for having students investigate the probability of outcomes when tossing two coins.
 - a) Divide students into pairs or small groups.
 - b) Inform students they will be experimenting to determine the possible outcomes, and the probability of each outcome, when tossing two coins. Have students create a recording sheet for their experiment (or distribute copies of BLM 7.SP.4.3: Experimental Probability Tally Sheet and Probability of Outcomes).
 - c) Tell students they will identify all possible outcomes and predict the probability of each outcome.

- d) Discuss whether the procedure for tossing the coins (tossing both coins at once, or tossing them one after the other) will affect the results of the experiment.
- Neither will affect the probability; however, good experimental technique ensures that the same procedure is followed as closely as possible throughout an experiment.
2. Have students conduct the investigation in pairs or in small groups.
 - a) Distribute two coins to each group.
 - b) Have students conduct their experiment for a given number of coin tosses, or for a set period of time.
 - c) Have students total their results.
 - d) Consolidate students' data on the demonstration board.
 3. Compare students' results to their predictions, and discuss differences or similarities.

If students predicted a probability of $\frac{1}{3}$ for each outcome, the results will likely not support that prediction. This raises an opportunity for discussing how to determine the sample space (number of possible outcomes) for two independent events.
 4. Calculate probability as the number of favourable outcomes out of the number of possible outcomes (the sample space).

$$P = \frac{\text{Number of Favourable Outcomes}}{\text{Number of Possible Outcomes}}$$

- a) Agree that the favourable outcomes are two heads, two tails, or one of each.
- b) Ask students to identify all possible outcomes.
5. Ask students to demonstrate, or demonstrate for them, systematic ways to organize the sample space for two independent events in a way that ensures all possible outcomes are identified. If students do not see the benefits of organizational charts, have them identify the sample space for events with multiple outcomes, such as rolling two number cubes.
6. Organizers include the following (see Background Information for examples):
 - a) tree diagrams
 - b) frequency charts or tables
 - c) organized lists
7. Have students make a math journal entry illustrating methods to identify the sample space (all possible outcomes) for two independent events.

Variations:

- Use computer applets to simulate coin tosses.
- Replace the introductory investigation with a guided example of tossing two coins as two independent events. Demonstrate calculating the sample space with a tree

diagram, and then with a frequency chart or table, as illustrated in the Background Information.

- Demonstrate using organizers for identifying the sample space for an experiment involving two independent events, and then have students identify such an experiment and use two methods to identify the corresponding sample space. Students may use events from the list they created in the previous learning experience.



Observation Checklist

- Listen to and observe students' responses to determine whether students can do the following:
 - Identify the sample space (all possible outcomes) for an experiment involving two independent events using a tree diagram, a table, or another graphic organizer.

Suggestions for Instruction

- **Determine the theoretical probability of an outcome for an experiment involving two independent events.**
- **Conduct a probability experiment for an outcome involving two independent events, with or without technology, to compare the experimental probability to the theoretical probability.**

Materials:

- manipulatives (e.g., coins, number cubes, colour counters, marbles, letter tiles, bags)
- software programs or online applets (such as those listed in the Background Information)
- BLM 7.SP.6.1: Frequency Chart for Organizing Outcomes for Two Independent Events (optional)

Organization: Individual or pairs

Procedure:

1. Inform students they will design and conduct a probability experiment involving two independent events, as outlined in the following steps.
 - a) Choose two independent events. Previous lists provide examples of events to choose from.
 - b) Determine the sample space (all possible outcomes) by drawing a tree diagram, a frequency chart, or another organizer. BLM 7.SP.6.1: Frequency Chart for Organizing Outcomes for Two Independent Events may be provided as a template.

- c) Determine the theoretical probability of an outcome for the experiment.
 - d) Conduct the experiment using manipulatives or computer applets or software programs.
 - e) Determine the experimental probability for the outcome.
 - f) Compare the experimental probability to the theoretical probability. Include descriptive statements and numerical statements in the comparisons. Propose an explanation for variations in the results.
2. Have students present their investigations to each other, or post the investigations for students to view.

Variations:

- Assign students two independent events to use for the experiment.
- Have all students work on the same investigation, and compile their results for comparing the theoretical and experimental probability.



Observation Checklist

- Listen to and observe students' responses to determine whether students can do the following:
 - Determine the theoretical probability of an outcome for an experiment involving two independent events.
 - Conduct a probability experiment for an outcome involving two independent events, with or without technology, to compare the experimental probability to the theoretical probability.

Suggestions for Instruction

- **Solve a probability problem involving two independent events.**

Materials:

- demonstration board
- display board

Organization: Whole class, pairs

Procedure:

1. Identify games of chance that involve two independent events, such as the following:
 - Rock, Paper, Scissors (played with two people)
 - games that involve rolling number cubes (e.g., Lucky Seven)
 - games that involve drawing marbles from a bag (e.g., Player A draws a marble from a bag containing a given assortment of marbles, and returns the marble to the bag. Player B then draws a marble. If the colours match, Player B scores a point; if they don't match, Player A scores the point.)
2. Ask whether a game is fair, and how one judges whether or not it is fair.
3. As a class, investigate a game of chance, such as Rock, Paper, Scissors, to determine whether or not the game is fair.
4. Have individuals or pairs of students determine whether or not other games of chance are fair. Have them provide evidence for their conclusions.
5. Provide opportunities for students to play the games.
6. Use students' results to create a display entitled *Would You Play This Game?*

Variations:

- Have pairs of students play a game based on the probability of two independent events occurring. After a certain time has passed, ask students who thinks the game is fair. Challenge students to support their opinion using what they know about probability.
- Have students design a fair game based on the probability of two independent events occurring. Have them provide evidence that the game is fair. Host a Game Fair in which students introduce and play their games with others.



Observation Checklist

- Listen to and observe students' responses to determine whether students can do the following:
 - Solve a probability problem involving two independent events.

Suggestions for Instruction

- **Solve a probability problem involving two independent events.**

Materials:

- BLM.7.SP.6.2: Probability Problems Involving Two Independent Events
- file cards (optional)

Organization: Individual, pairs

Procedure:

1. Present students with probability problems involving two independent events, such as those on BLM.7.SP.6.2: Probability Problems Involving Two Independent Events.
2. Ask students to complete the problems independently and then compare their responses with those of a classmate, resolving any discrepancies.

Variations:

- Ask students to design their own probability problems and solutions. Have students consolidate problems as an assignment sheet and an answer key, and share question sheets with others. Students compare their responses to the answer key, and discuss any discrepancies with the authors.
- Place student-created probability problems and solutions on large file cards. Students can pick a card or two, and complete the problems as part of a learning activity centre or as an Exit Slip.
- Play online probability games requiring players to solve probability problems involving both simple and independent events.

Sample Website:

For a sample probability game, refer to the following website:

Math-Play.com. *Probability Game*. 2007.

www.math-play.com/Probability-Game.html.



Observation Checklist

- Listen to and observe students' responses to determine whether students can do the following:
 - Solve a probability problem involving two independent events.

PUTTING THE PIECES TOGETHER



Defining the Average Potato

Introduction:

Students collect data, determine measures of central tendency, consider the range and the effect of outliers, and analyze circle graphs in order to define the average potato.

Purpose:

In this investigation, students will demonstrate the ability to do the following (connections to learning outcomes are identified in parentheses):

- Determine measures of central tendency (mean, median, and mode) and range. (7.SP.1)
- Determine the most appropriate measures of central tendency to report findings. (7.SP.1)
- Determine the effect on the mean, median, and mode when an outlier is included in the data. (7.SP.2)
- Construct circle graphs to solve problems. (7.SP.3)
- Express probabilities as ratios, fractions, and percents. (7.SP.4)

Students will also demonstrate the following mathematical processes:

- Communication
- Connections
- Mental Mathematics and Estimation
- Problem Solving
- Reasoning
- Technology

Materials/Resources:

- Each student will require
 - a potato
 - a data sheet
 - a way to label each potato (e.g., adhesive tape)
- Each group will require
 - a tape measure or string
 - a ruler (cm)
 - a mass scale

- a setup for measuring volume (e.g., water, a basin, a container with a wide mouth filled to the brim that sits inside another container with a pour spout, a measuring cup to measure the overflow, towels for cleaning up spills)
- a calculator
- a compass
- a protractor

Organization: Small groups (of four or five)

Procedure:

1. Ensure each member of your group has a potato, an assigned letter of the alphabet, and a copy of the Data Sheet for Determining the Average Potato.
2. Label your potato with the letter of the alphabet you were assigned. Give your potato a name that begins with that letter, and record the name on your data sheet. Count the number of eyes on your potato, and record the number on your data sheet.
3. Measure and record the length around (cm), the breadth (cm), the mass (gr), and the volume (mL) of your potato.
4. When the measuring is complete, have each person in your group clearly read and repeat his or her data aloud. Listen carefully to your classmates' data and record it accurately.
5. After all the data has been collected, work as a group to define the average potato.
 - a) Have each group member take responsibility to calculate the measures of central tendency for one of the potato measures.
 - b) Identify the range and any outliers, and discuss the effect of the outliers on the measures of central tendency.
 - c) Prepare circle graphs for each potato measure to help define the average potato.
 - d) As a group, agree on a definition for an average potato.
 - e) Determine the number of potatoes that would fit your definition of an average potato. What is the experimental probability that a potato in the group would be an average potato, according to your definition? Explain.
 - f) Prepare to present your group's definition and a defence of that definition to the class.
6. Present definitions to the class, and take part in a discussion. Does the class agree on a definition for an average potato? Explain.



Observation Checklist

- Listen to and observe students' responses to determine whether students can do the following:
 - Determine measures of central tendency.
 - Determine the affect of outliers included in the data.
 - Determine the most appropriate measures of central tendency to report findings.
 - Construct circle graphs to solve problems.

Extension (Optional):

Students design an average-potato lottery and compare the experimental results to the theoretical probability of winning.

Purpose:

In this extension, students will demonstrate the ability to do the following (connections to learning outcomes are identified in parentheses):

- Express probabilities as ratios, fractions, and percents. (7.SP.4)
- Define the sample space for the probability experiment. (7.SP.5)
- Compare the theoretical and experimental probability of two independent events. (7.SP.6)

Procedure:

- Use the collected data and the agreed-upon definition to hold a potato lottery. Define the criteria for the lottery. The winner could receive the potatoes.
- Randomly select five or six potatoes from your group. Calculate the theoretical probability of selecting an average potato from the group twice in a row, given the first potato is returned to the bunch after it has been selected. Determine the experimental probability of the same event by holding a class lottery. The potatoes could serve as the lottery prize.

Data Sheet for Determining the Average Potato					
Name	Length around (cm)	Breadth (cm)	Mass (gr)	Volume (mL)	Number of Eyes
A					
B					
C					
D					
E					
F					
G					
H					
I					
J					
K					
L					
M					
N					
O					
P					
Q					
R					
S					
T					
U					
V					
W					
X					
Y					
Z					
Total					
Mean					
Median					
Mode					

NOTES



GRADE 7 MATHEMATICS

Appendix: Models for Computing Decimal Numbers

APPENDIX: MODELS FOR COMPUTING DECIMAL NUMBERS

This appendix focuses on demonstrating computation with decimal numbers using base-10 blocks and number lines.

Base-10 Blocks

Base-10 blocks can be used to represent the operations of addition, subtraction, multiplication, and division of decimal numbers.

The model is based on viewing decimals as fractional equivalents. A fraction is viewed as a whole, cut into equivalent pieces. The whole is divided into tenths to represent $\frac{1}{10}$ or 0.1. The whole is divided into hundredths to represent $\frac{1}{100}$ or 0.01.

Students must have a fluent understanding of the numeric values of the model. If they lack this understanding, their attention will be focused on trying to make the model instead of learning to work with decimal numbers. Have students physically separate the blocks, or cut paper grids, to help them attach meaningful values to the representations. Spend time naming various combinations of blocks and creating representations of various decimal numbers to develop fluency.

Base-10 grid paper serves as a two-dimensional representation of the base-10 blocks. (See BLM 5–8.10: Base-Ten Grid Paper.)

Note: It is important that students work flexibly with various representations to develop their understanding of operations with decimal numbers, rather than memorizing the steps without understanding their meaning.

Representations*

If the flat represents a whole,

- its value is 1
- its dimensions are 1 unit by 1 unit
- it has an area of 1 unit²

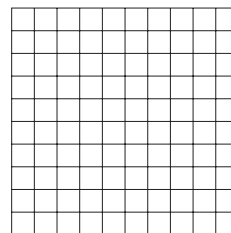

or



If the rod represents one-tenth of a whole,

- its value is 0.1
- its dimensions are 1 unit by 0.1 unit
- it has an area of 0.1 units²



or

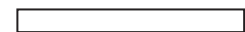

* For the purposes of this resource, models are represented without all individual blocks drawn.

If the small cube represents one-hundredth of a whole,



- its value is 0.01
- its dimensions are 0.1 unit by 0.1 unit
- it has an area of 0.01 units²

Arranging the Blocks as Arrays or Area Models

0.2 units²

requires 2 tenths rods (or 20 hundredths cubes)

it may be arranged as 1×0.2

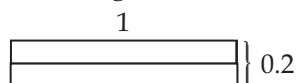

or

2×0.1

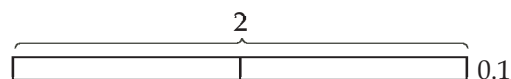

2.2 units²

requires 2 flats and 2 rods (or 22 rods or 220 cubes)

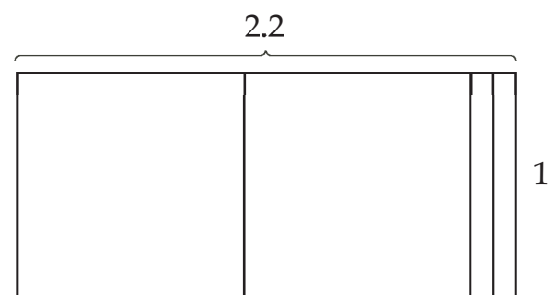

It is important to establish a convention of keeping the blocks organized, as it will help with developing future representations. This model is arranged as 2.2×1 .

Modelling Addition

If you think it would be helpful, have students work on place value mats.

Model $1.46 + 0.45$:

- Select the blocks to represent 1.46. (1 flat, 4 rods, 6 small cubes)

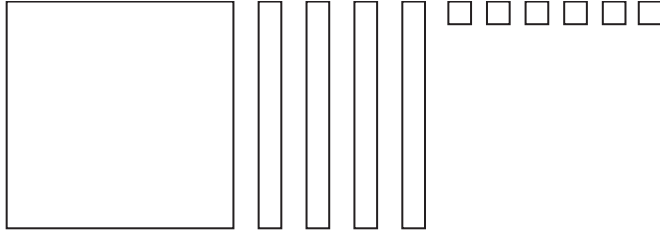

- Select the blocks to represent 0.45. (4 rods, 5 small cubes)

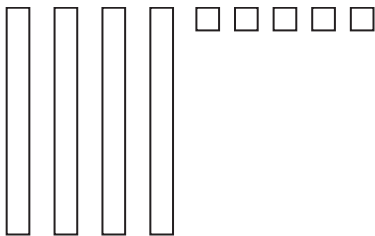

- Combine the blocks together.

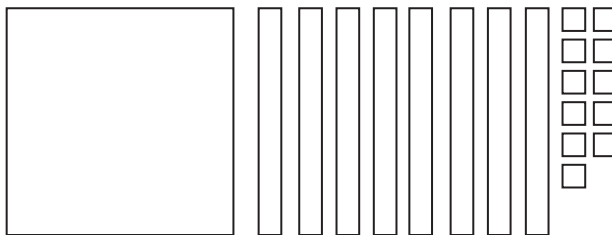

- Group similar blocks where possible.

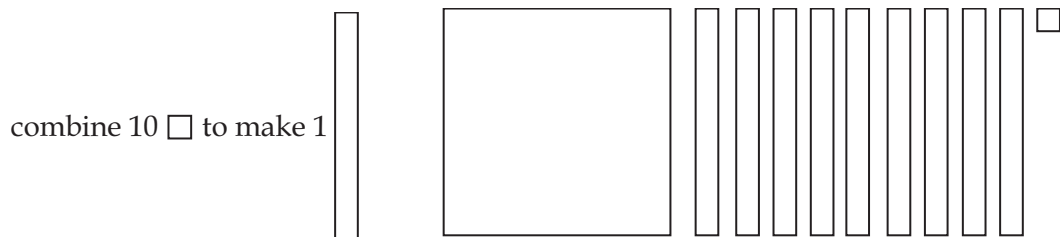

- Ten blocks of one value are exchanged for one block of the next larger value.
- The new quantity represents 1.91.

Modelling Subtraction

If you think it would be beneficial, have students work on place value mats.

Model $2.36 - 0.85$:

- Select the blocks to represent 2.36. (2 flats, 3 rods, 6 small cubes)

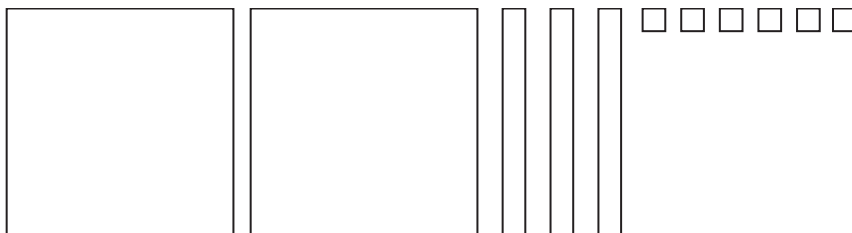

- If possible, remove blocks that represent 0.85. (8 rods, 5 small cubes)

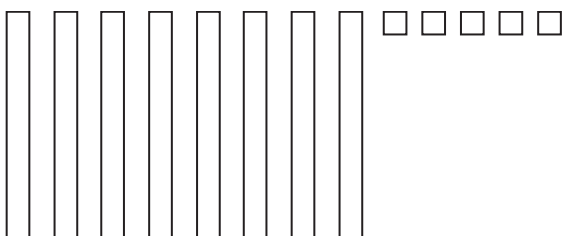

- If there are insufficient similar blocks to allow removal of the required amount, exchange one block of the next largest value for 10 of the required blocks.

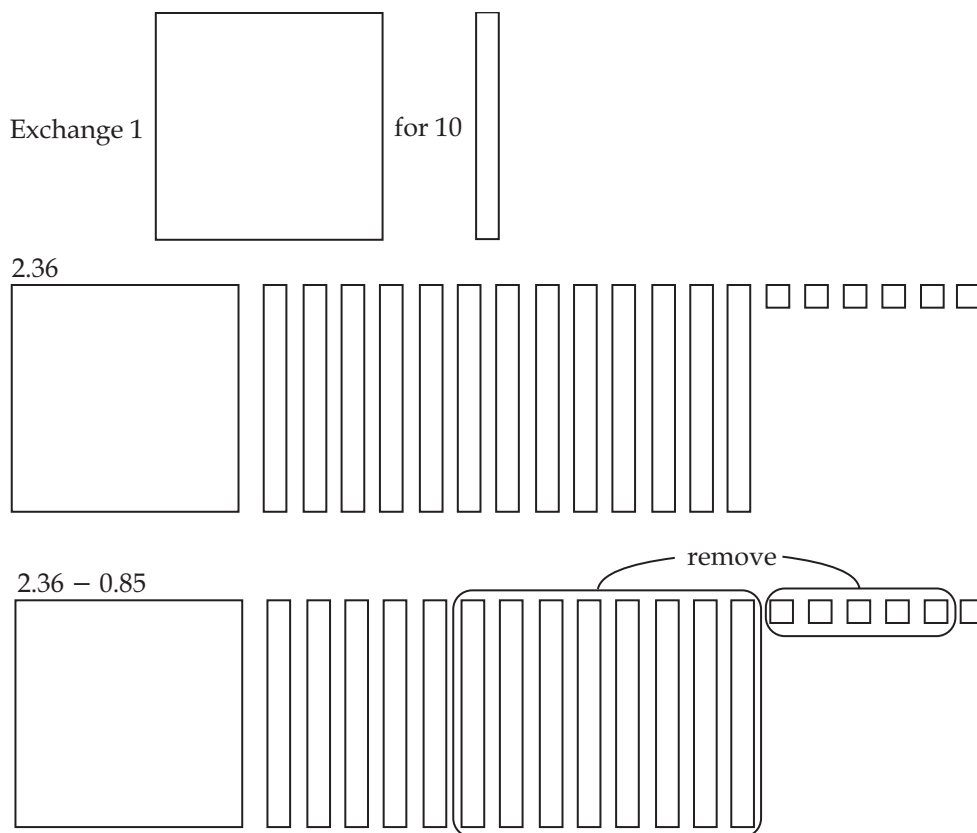

- The new quantity represents 1.51.

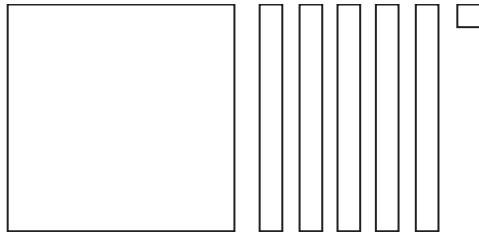

Modelling Multiplication

Base-10 blocks can be used to represent both the active understanding of multiplication as a specific number of groups of a specific size, or the non-active array representation of a quantity.

When the blocks are arranged as a rectangle, the rectangle may be rotated, and the quantity does not change. This is a verification of the commutative property of multiplication. The orientation of the array has no affect on the result, but in some places a convention has been established of representing the first number horizontally and the second vertically.

The array also serves as a model for area. It represents the area covered by a rectangle with a length of the multiplicand and a width of the multiplier, or vice versa.

Model 2×0.4 using active understanding:

- Understand the statement as 2 groups of 0.4.
- Select blocks to represent 1 group of 4 tenths.
- Select a second group of 4 tenths.
- Combine the two groups.
- The new quantity represents 0.8.

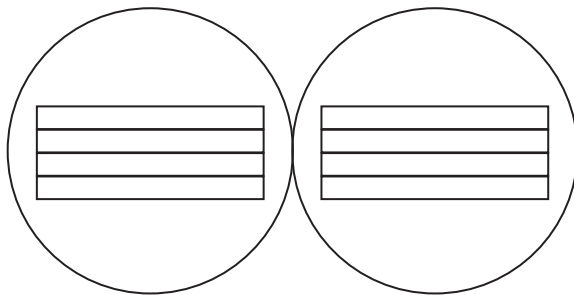

Model 2×0.4 using non-active understanding:

- Arrange the blocks into a rectangle, with one dimension having a linear measure of 2 units and the other dimension having a linear measure of 0.4.
- The arrangement requires 8 rods and represents 0.8.
- Rotating this model represents the commutative property of multiplication.

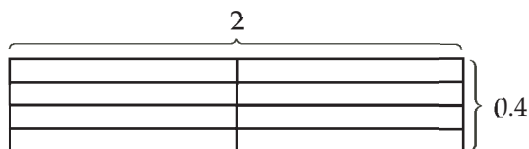

Modelling Division

Model $1.4 \div 2$ using active understanding:

- Understand the statement as either how many groups of 2 are in 1.4 or how many will be in each group if 1.4 is shared between 2 groups.
- Select base-10 blocks to represent 1.4.
- Divide the blocks into 2 groups.
- The quotient is 0.7.

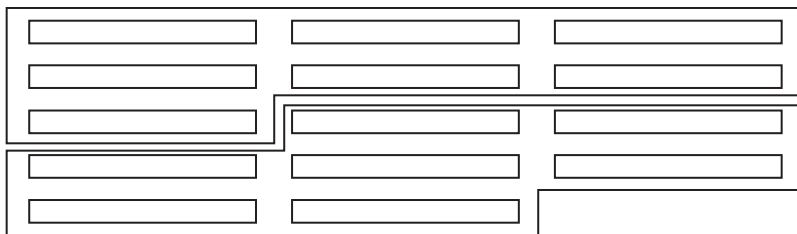

Model $1.4 \div 2$ using non-active understanding:

- Represent the divisor (1.4) as a rectangle with the length of one side equal to the dividend (2).
- The length of the other side will be the quotient.

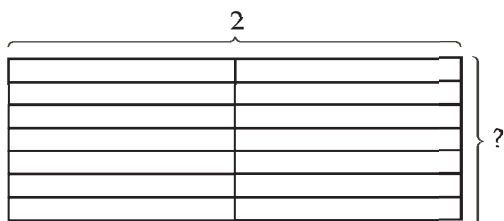

Number Lines

Modelling Division

$$8 \div 4 = 2$$

Begin at 8, and jump back to 0, putting 4 steps in each jump. It takes 2 jumps to reach 0.

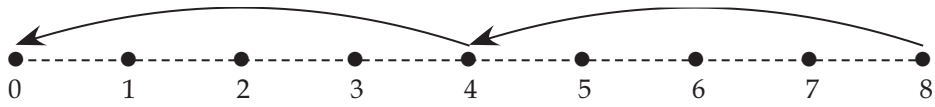

$$8 \div 0.4 = 20$$

As 0.4 is less than 0.5 of a jump, there are more than 2 jumps of 0.4 in each 1, so there are more than 16 jumps in 8. This is a good place to discuss estimating strategies and the concept that the result of a number divided by less than 1 will always be larger than the original number.

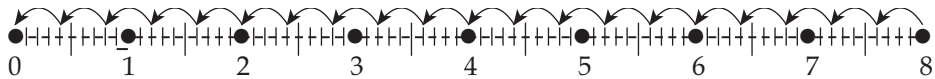

$$0.8 \div 0.4 = 2$$

Change the values on the line to tenths. Jumping back by 0.4 requires 2 jumps.

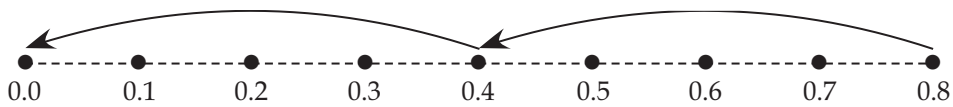

$$0.8 \div 4 = 0.2$$

Take the 0.8 spaces and divide them into 4 groups. Each group contains 0.2.



NOTES



GRADE 7 MATHEMATICS

Bibliography

BIBLIOGRAPHY

- Earl, Lorna M., Steven Katz, and Western and Northern Canadian Protocol for Collaboration in Education. *Rethinking Classroom Assessment with Purpose in Mind: Assessment for Learning, Assessment as Learning, Assessment of Learning*. Winnipeg, MB: Manitoba Education, Citizenship and Youth, 2006. Available online at www.edu.gov.mb.ca/k12/assess/wncp/index.html.
- Gravett, Emily. *The Rabbit Problem*. London, UK: Macmillan Children's Books, 2009.
- Kilpatrick, J., J. Swafford, and B. Findell, eds. *Adding it Up: Helping Children Learn Mathematics*. Washington, DC: National Academy Press, 2001.
- MacPherson, Eric D., and Leon A. Rousseau. *A Nomological Network for Elementary School Mathematics*. 6th ed. Winnipeg, MB: The University of Manitoba, 1994.
- Manitoba Education. *Grade 5 Mathematics: Support Document for Teachers*. Winnipeg, MB: Manitoba Education, 2009. Available online at www.edu.gov.mb.ca/k12/cur/math/support_gr5/index.html.
- . *Grade 8 Mathematics: Support Document for Teachers*. Winnipeg, MB: Manitoba Education, 2011. Available online at www.edu.gov.mb.ca/k12/cur/math/support_gr8/index.html.
- . *Kindergarten to Grade 8 Mathematics: Manitoba Curriculum Framework of Outcomes (2013)*. Winnipeg, MB: Manitoba Education, 2013. Available online at www.edu.gov.mb.ca/k12/cur/math/framework_k-8/index.html.
- Manitoba Education and Advanced Learning. *Glance Across the Grades: Kindergarten to Grade 9 Mathematics*. Winnipeg, MB: Manitoba Education and Advanced Learning, 2015. Available online at www.edu.gov.mb.ca/k12/cur/math/glance_k-9/index.html.
- . *Middle Years Assessment: Grade 7 Mathematics: Support Document for Teachers: English Program*. Winnipeg, MB: Manitoba Education and Advanced Learning, 2015. Available online at www.edu.gov.mb.ca/k12/assess/support/math7/.
- Manitoba Education and Training. *Grades 5 to 8 Mathematics: A Foundation for Implementation*. Winnipeg, MB: Manitoba Education and Training, 1997.
- . *Success for All Learners: A Handbook on Differentiating Instruction: A Resource for Kindergarten to Senior 4*. Winnipeg, MB: Manitoba Education and Training, 1996.
- Manitoba Education, Citizenship and Youth. *Grades 9 to 12 Mathematics: Manitoba Curriculum Framework of Outcomes*. Winnipeg, MB: Manitoba Education, Citizenship and Youth, 2009. Available online at www.edu.gov.mb.ca/k12/cur/math/framework_9-12/.
- . *Kindergarten to Grade 8 Mathematics Glossary: Support Document for Teachers*. Winnipeg, MB: Manitoba Education, Citizenship and Youth, 2009. Available online at www.edu.gov.mb.ca/k12/cur/math/glossary_k-8/index.html.

- McCallum, Ann. *Rabbits Rabbits Everywhere: A Fibonacci Tale*. Illus. Gideon Kendall. Watertown, MA: Charlesbridge Publishing Inc., 2007.
- Neuschwander, Cindy. *Sir Cumference and the Isle of Immeter: A Math Adventure*. Illus. Wayne Geehan. Watertown, MA: Charlesbridge Publishing Inc., 2006.
- . *Sir Cumference and the Viking Map: A Math Adventure*. Illus. Wayne Geehan. Watertown, MA: Charlesbridge Publishing Inc., 2012.
- OECD (Organisation for Economic Co-operation and Development). *PISA 2012 Field Trial Problem Solving Framework*. September 30, 2012.
www.oecd.org/pisa/pisaproducts/46962005.pdf.
- Ontario. Ministry of Education. *The Ontario Curriculum Grades 1–8: Mathematics*. Ontario: Ministry of Education, 2005. Available online at www.edu.gov.on.ca/eng/curriculum/elementary/math18curr.pdf.
- Sachar, Louis. *More Sideways Arithmetic from Wayside School*. New York, NY: Scholastic Inc., 1994.
- . *Sideways Arithmetic from Wayside School*. New York, NY: Scholastic Inc., 1989.
- Small, Marian. *Making Math Meaningful to Canadian Students, K–8*. Toronto, ON: Nelson Education Ltd., 2009.
- Timmons, Daniel L., Catherine W. Johnson, and Sonya M. McCook. *Fundamentals of Algebraic Modeling: An Introduction to Mathematical Modeling with Algebra and Statistics*. 5th ed. Belmont, CA: Brooks/Cole Cengage Learning, 2010.
- Van de Walle, John A., and Sandra Folk. *Elementary and Middle School Mathematics: Teaching Developmentally*. 2nd Canadian ed. Toronto, ON: Pearson Education Canada, 2010.
- Van de Walle, John A., and LouAnn H. Lovin. *Teaching Student-Centered Mathematics Grades 5–8*. Boston, MA: Pearson Education, Inc., 2006.
- Western and Northern Canadian Protocol (WNCP). *The Common Curriculum Framework for K–9 Mathematics*. Edmonton, AB: Governments of Alberta, British Columbia, Manitoba, Northwest Territories, Nunavut Territory, Saskatchewan, and Yukon Territory, May 2006. Available online at www.wncp.ca/english/subjectarea/mathematics/ccf.aspx.

Websites

Any websites referenced in this document are subject to change. Educators are advised to preview and evaluate websites and online resources before recommending them for student use.

- Barile, Margherita. “Eye of Horus Fractions.” *MathWorld*. 1999–2012. A Wolfram Web Resource, created by Eric W. Weisstein.
<http://mathworld.wolfram.com/EyeofHorusFraction.html> (12 Jan. 2012).

- BBC. "Shape, Space and Measures." *KS2 Bitesize*. 2011. www.bbc.co.uk/schools/ks2bitesize/maths/shape_space/transformation/play.shtml (19 July 2011).
- Bogomolny, A. "Area of Triangle." *Interactive Mathematics Miscellany and Puzzles*. 1996–2011. www.cut-the-knot.org/Curriculum/Geometry/AreaOfTriangle.shtml (20 Dec. 2011).
- Broderick, Shawn D. "Essay 2: Constructing Regular Polygons." *Jim Wilson, University of Georgia*. <http://jwilson.coe.uga.edu/EMAT6680Fa08/Broderick/essay2/essay2.html> (26 May 2016).
- Crossword Puzzle Games. *Create a Crossword Puzzle*. 2003. www.crosswordpuzzlegames.com/create.html (28 Dec. 2011).
- "File:Overhand-folded-ribbon-pentagon.svg." *Wikipedia: The Free Encyclopedia*. Wikimedia Foundation, Inc. <https://commons.wikimedia.org/wiki/File:Overhand-folded-ribbon-pentagon.svg?uselang=en-ca> (26 May 2016).
- FunBased Learning. "Medium Version of Graph Mole." *Graphing*. 2007. <http://funbasedlearning.com/algebra/graphing/points2/> (19 July 2011).
- GreatScott.com. "Eye of Horus Fractions." *Hieroglyphs*. 1998–2011. www.greatscott.com/hiero/eye.html (12 Jan. 2012).
- "How to Construct Regular Polygons Using a Circle." *wikiHow*. www.wikihow.com/Construct-Regular-Polygons-Using-a-Circle (26 May 2016).
- Lawrence, Snezana. "Eye of Horus Fractions." *Maths Is Good for You!* www.mathsisgoodforyou.com/topicsPages/egyptianmaths/horusfractions.htm (12 Jan. 2012).
- Manitoba Education. "Middle Years Activities and Games." *Mathematics*. www.edu.gov.mb.ca/k12/cur/math/my_games/index.html (19 July 2011).
- The Math Forum @ Drexel. "Ancient Greek Maps." *Chameleon Graphing*. 1994–2011. <http://mathforum.org/cgraph/history/greekmaps.html> (19 July 2011).
- MathIsFun.com. "Symmetry Artist." *Geometry*. 2011. www.mathsisfun.com/geometry/symmetry-artist.html (19 July 2011).
- Math Open Reference. *Angles*. 2009. www.mathopenref.com/tocs/anglestoc.html (23 Nov. 2011).
- . "Area of a Triangle." *Triangles*. 2009. www.mathopenref.com/trianglearea.html (24 Nov. 2011).
- . "Central Angle." *Circles*. 2009. www.mathopenref.com/circlecentral.html (19 July 2011).
- . *Circles*. 2009. www.mathopenref.com/tocs/circlestoc.html (23 Nov. 2011).
- Math-Play.com. "The Coordinate Plane." *Coordinate Plane Game*. www.math-play.com/Coordinate%20Plane%20Game/Coordinate%20Plane%20Game.html (19 Nov. 2011).

- . *Probability Game*. 2007. www.math-play.com/Probability-Game.html (19 July 2011).
- Math Playground. "Circle Graphs." *Math Manipulatives*. 2010. www.mathplayground.com/piechart.html (19 July 2011).
- "Nonagon." *Wikipedia: The Free Encyclopedia*. Wikimedia Foundation, Inc. <https://en.wikipedia.org/wiki/Nonagon> (26 May 2016).
- Plotting Coordinates.com. *CoordinArt News*. 2008–2010. www.plottingcoordinates.com/coordinartnews.html (19 July 2011).
- Reed, Jim. "33.01 The Coordinate Plane." *Grade 7: The Learning Equation Math*. 1999. <http://staff.argyll.epsb.ca/jreed/math7/strand3/3301.htm> (19 July 2011).
- Scweb4free.com. *Circle Graphs Game*. 2009. www.scweb4free.com/circle.html (19 July 2011).
- Shodor. "Experimental Probability." *Interactive*. 1994–2011. www.shodor.org/interactivate/activities/ExpProbability/ (19 July 2011).
- . "Transmographer." *Interactive*. 1994–2011. www.shodor.org/interactivate/activities/Transmographer/ (19 July 2011).
- Stapel, Elizabeth. *Purplemath*. 1999–2011. www.purplemath.com (19 July 2011).
- Statistics Canada. www.statcan.gc.ca/ (3 Sept. 2015).
- Stich, Mike. "Parallelogram." 26 May 2006. *flickr*. www.flickr.com/photos/mdstich/357560359/ (19 July 2011).
- U.S. Department of Education. Institute of Education Sciences, National Center for Education Statistics. "Create a Graph." *Kids' Zone, Learning with NCES*. <http://nces.ed.gov/nceskids/createagraph/> (19 July 2011).
- Utah State University. "Data Analysis and Probability." *National Library of Virtual Manipulatives*. 1999–2010. http://nlvm.usu.edu/en/nav/topic_t_5.html (19 July 2011).
- . *National Library of Virtual Manipulatives*. 1999–2010. <http://nlvm.usu.edu/en/nav/vlibrary.html> (19 July 2011).
- . "Number and Operations (Grades 3–5)." *National Library of Virtual Manipulatives*. 1999–2010. http://nlvm.usu.edu/en/nav/category_g_2_t_1.html (19 July 2011).
- Wolfram Demonstrations Projects. *Symbol Rotation Patterns*. Contributed by Danielle Nogle. Based on a program by Chris Carlson. 2011. <http://demonstrations.wolfram.com/SymbolRotationPatterns/> (19 July 2011).
- World-Mysteries.com. "Fibonacci Numbers in Nature and the Golden Ratio." *Science Mysteries*. 2002–2011. http://old.world-mysteries.com/sci_17.htm (10 June 2016).



Printed in Canada
Imprimé au Canada