

Spanish Language and Culture

**Six-Year Junior/Senior High School Program
Implementation Manual**

**Western and Northern Canadian Protocol for
Collaboration in Basic Education**

March 2004

SPANISH LANGUAGE AND CULTURE

***SIX-YEAR JUNIOR/SENIOR
HIGH SCHOOL PROGRAM***

Implementation Manual

March 2004

Manitoba Education, Citizenship and Youth Cataloguing in Publication Data

468.2421 Spanish language and culture, six-year junior / senior
high school program : implementation manual

ISBN 0-7711-3135-6

1. Spanish language—Study and teaching as a second language (Secondary)—Canada, Western. 2. Spanish language—Study and teaching as a second language (Secondary)—Canada, Northern. 3. Spanish language—Study and teaching (Secondary)—English speakers. I. Western and Northern Canadian Protocol for Collaboration in Basic Education.

Copyright © 2004, the Crown in Right of Manitoba as represented by the Minister of Education, Citizenship and Youth. Manitoba Education, Citizenship and Youth, School Programs Division, 1970 Ness Avenue, Winnipeg, Manitoba R3J 0Y9.

Every effort has been made to acknowledge original sources and to comply with copyright law. If cases are identified where this has not been done, please inform Manitoba Education, Citizenship and Youth. Errors or omissions will be corrected in a future edition.

ACKNOWLEDGEMENTS

Spanish Language and Culture, Six-Year Junior/Senior High School Program: Implementation Manual was developed through the cooperative efforts of Manitoba, Saskatchewan, and Alberta under the Western and Northern Canadian Protocol for Collaboration in Basic Education. These jurisdictions acknowledge the contributions made by the following individuals.

Members of the Spanish Language and Culture Development Teams

Alberta

Aline deBourcier	Consultant for International Languages, Edmonton Public Schools
John Sokolowski	Program Manager, Alberta Learning

Manitoba

Liliana Ardiles	Teacher, Collège Louis-Riel Division Scolaire Franco-Manitobaine
Gorette Bento	Teacher, Silver Heights Collegiate St. James-Assiniboia School Division
Tess Cordeiro	Teacher, Oak Park High School Pembina Trails School Division
Felipe Flores	Professor, Department of French, Spanish and Italian University of Manitoba
Mandy Freynet	Teacher, Collège Jeanne-Sauvé, Louis Riel School Division
Ani Granson	Web Technologies Consultant, Manitoba Education, Citizenship and Youth
Rossana McCormack	Instructor/Teacher The Collegiate at the University of Winnipeg
Mara Reich	Instructor, Collège universitaire de Saint-Boniface
Antonio Tavares	Multicultural Education Consultant Manitoba Education, Citizenship and Youth
Diana Zozman	Languages other than English Consultant River East-Transcona School Division

Saskatchewan

Dr. Joan Boyer	Second Languages Consultant, Saskatchewan Learning
----------------	--

Manitoba Education, Citizenship and Youth Staff

Lynn Harrison	Desktop Publisher, Production Support Unit
Grant Moore	Publications Editor, Production Support Unit
Marjorie Poor	Publications Editor

Special acknowledgement to the New Jersey State Department of Education for permission to use materials from the *New Jersey World Languages Curriculum Framework*.

CONTENTS

Introduction

Spanish Language and Culture: Implementation Overview

Achieving the Outcomes

Year 1

Year 2

Year 3

Year 4

Year 5

Year 6

Teaching and Learning Spanish Language and Culture

Classroom Assessment

Planning for Instruction and Assessment

Planning Tools

Sample Plans

Appendices

References

INTRODUCTION

Over 300 million people in the world speak Spanish. It is the official language of the following countries: Argentina, Bolivia, Chile, Colombia, Costa Rica, Cuba, Dominican Republic, Ecuador, El Salvador, Equatorial Guinea, Guatemala, Honduras, Mexico, Nicaragua, Panama, Paraguay, Peru, Puerto Rico, Spain, Uruguay, and Venezuela. It is also spoken in many other countries in which it is not the official language, including the United States of America and the Philippines. It is one of the most widely spoken languages in the world.

The value of learning the Spanish language is enormous for Canadian society as a whole. Apart from the common advantages related to the learning of an international language, learning Spanish permits an insight into the rich and varied cultures in the Spanish-speaking world and bestows more opportunity to communicate directly with its people. As well, for some students with a prior knowledge of the language and cultures, it offers an opportunity for renewed contact and contributes to maintaining and developing literacy.

The learning of Spanish, or any other language, develops awareness of and sensitivity to cultural and linguistic diversity, is a means of cultural enrichment, and is a good way of fostering understanding and solidarity among peoples and countries. Furthermore, it gives individuals the opportunity to identify, question, and challenge their own cultural assumptions, values, and perspectives, and to contribute positively to society.

There is also significant evidence to suggest that learning another language contributes to the development of increased grammatical abilities in the first language and enhances cognitive functioning. Learning a second language increases the ability to conceptualize and to think abstractly; and it fosters more cognitive flexibility, greater divergent thinking, creativity, and metalinguistic competence.

Moreover, in today's world, knowledge of a second language and culture in general is a benefit for individuals, enabling them to communicate and interact effectively in the global marketplace and workplace. Given the important social and economic role Spanish-speaking countries are playing in the international scene, and given their increasing economic and cultural presence in Western Canada, the learning of Spanish provides an important economic advantage.

Background

In 2000, the *Common Curriculum Framework for International Languages, Kindergarten to Grade 12* was developed through the cooperative efforts of the provinces of Saskatchewan, Manitoba, and Alberta, under the auspices of the Western Canadian Protocol for Collaboration in Basic Education. The intent of that document was to provide a common foundation and support for the development of curricula for international language programs.

Subsequently, drafts of *Program Studies: Spanish Language and Culture Grade 7 to Grade 9* and *Program of Studies: Spanish Language and Culture 10-20-30* were developed for use in the province of Alberta. These documents provided the basis, with some adaptations, for the WNCB *Spanish Language and Culture, Six-Year Junior/Senior High School Program* curriculum document. To support the implementation of this new curriculum, this *Spanish Language and Culture, Six-Year Junior/ Senior High School Program: Implementation Manual* has been developed collaboratively by the provinces of Alberta, Saskatchewan, and Manitoba.

Purpose

This implementation manual will assist educators as they

- plan for instruction that supports student achievement of the outcomes
- monitor student progress in achieving the outcomes
- select learning resources to support their professional development
- select student learning resources to enhance instruction and assessment

Educators, administrators, and parents may use this document in a variety of ways.

Teachers (Educators)

Classroom teachers will find theoretical information and research concepts in the Spanish Language and Culture: Implementation Overview. Specific programming and classroom information are found in Achieving the (Six-Year Junior/Senior High School Program) Outcomes.

Administrators

Administrators will find essential information in the Spanish Language and Culture: Implementation Overview, and Achieving the (Six-Year Junior/Senior High School Program) Outcomes. These sections may be of particular value in

- developing a programming plan for a school
- identifying directions for professional development
- developing school/divisional assessment policies and procedures
- selecting professional resources

Parents

Parents may be directed to Spanish Language and Culture: Implementation Overview for information about Spanish as an international language and about second language learning in general. Achieving the (Six-Year Junior/Senior High School Program) Outcomes provides grade-specific information and insights into classroom practices.

Notes

SPANISH LANGUAGE AND CULTURE: IMPLEMENTATION OVERVIEW

The Benefits of Second Language Learning	3
The Benefits of Learning Spanish Language and Culture	5
The Second/International Language Learner	7
Brain Research and Second Language Learning	11
Considerations for Effective Spanish Language and Culture Programs	13

IMPLEMENTATION OVERVIEW

The Benefits of Second Language Learning*

During the 1990s, there was renewed interest in language learning, especially with regard to Spanish and Asian languages in North America. There is now a growing appreciation of the role that multilingual individuals can play in an increasingly diverse society, and there is a greater understanding of the academic and cognitive benefits of learning other languages. The last decade has seen an emerging global interest in international languages and second language education. This has led researchers, policymakers, educators, employers, parents, and the media to reexamine the advantages of second or additional languages.

The 1990s have also been characterized as the “Decade of the Brain.” Increased research on brain development throughout the 1990s has focused attention on the learning process and developmental issues. Some of this research has analyzed the effect of language acquisition on the brain. The results of these studies have generated media interest in how early learning experiences, including first and second language acquisition, promote cognitive development. Most experts agree that making it possible for children to learn a second language early in life and beyond is entirely beneficial. A summary of the many benefits of learning a second language follows.

Personal Benefits

An obvious advantage of knowing more than one language is having expanded access to people and resources. Individuals who speak and read more than one language have the ability to communicate with more people, read more literature, and benefit more fully from travel to other countries. Introducing students to alternative ways of expressing themselves and to different cultures gives greater depth to their understanding of human experience by fostering an appreciation for the customs and achievements of people beyond their own communities. Ultimately, knowing a second language can also give people a competitive advantage in the work force by opening up additional job opportunities.

* Adapted: <<http://www.languagemagazine.com/internetedition/nd99/pg23.html>> Kathleen M. Marcos, Assistant Director, ERIC Clearinghouse on Languages and Linguistics Center for Applied Linguistics. Adapted from “Second Language Learning: Everyone Can Benefit.” *K-12 Foreign Language Education: The ERIC Review*, Volume 6, Issue 1, fall 1998.
<<http://www.accesseric.org/resources/ericreview/vol6no1/langlern.html#1>>

For many people, there's something inherently enjoyable about successfully speaking in another tongue. Learning a new language can be an intensely challenging and rewarding experience.

Cognitive Benefits

Some researchers suggest that students who receive second language instruction are more creative and better at solving complex problems than those who do not (Bamford and Mizokawa). Other studies suggest that bilingual individuals outperform similar monolinguals on both verbal and non-verbal tests of intelligence, which raises the question of whether ability in more than one language enables individuals to achieve greater intellectual flexibility (Bruck, Lambert, and Tucker; Hakuta; Weatherford).

Academic Benefits

Parents and educators sometimes express concern that learning a second language will have a detrimental effect on students' reading and verbal abilities in English. However, several studies suggest the opposite. Knowing a second language, according to the latest research on reading, can really help a child comprehend written languages faster and possibly learn to read more easily, provided that children are exposed to stories and literacy in both languages (Bialystok "Effects of Bilingualism"). By age four, bilingual children have progressed more than monolingual children in understanding the symbolic function of written language. By five, they are more advanced than monolinguals and bilinguals who have learned only one writing system, in understanding specific representation properties, even in English.

The positive effects of bilingualism were also documented in an American study analyzing achievement test data of students who had participated five years or more in "immersion" type international language programs in Fairfax County, Virginia. The study concluded that students scored as well as or better than all comparison groups and continued to be high academic achievers throughout their school years (Thomas, Collier, and Abbott). Numerous other studies have also shown a positive relationship between foreign language study and achievement in English language arts (Barik and Swain; Genesee *Learning*; Swain).

Societal Benefits

Bilingualism and multilingualism have many benefits to society. Canadians who are fluent in more than one language can enhance Canada's economic competitiveness abroad, maintain its political and security interests, and work to promote an understanding of cultural diversity within our nation. For example, international trade specialists, overseas media correspondents, diplomats, airline employees, and national security personnel need to be familiar with other languages and cultures to do their jobs well. Teachers, healthcare providers, customer service representatives, and law enforcement personnel also serve their constituencies more effectively when they can reach across languages and cultures. Developing the language abilities of the students now in school will improve the effectiveness of the work force later.

The Benefits of Learning Spanish Language and Culture

In this century, different languages and cultures will increasingly influence our lives. In the Americas, Spanish and the Latin American cultures will have a great impact. In Latin America, you need not only to speak Spanish, but also to be familiar with the culture to be successful.

Today, Spanish rivals English as the language of choice in the Americas with 250 million native Spanish speakers in the Caribbean, Central America, South America, and North America. In twenty years, one out of every six people living in the United States will be Spanish-speaking.

In Canada, our social and economic connections with the Spanish-speaking world are growing and developing at an exponential rate. In the last three decades, there has been a significant increase in Canadians of Spanish-speaking origin.

There are other reasons to consider learning Spanish:

- *A world language:* 300 million people speak Spanish, making it one of the largest markets for business and one of the most useful languages in the world for travel.
- *Better understanding of English:* Much of the vocabulary of English has Latin origins by way of French. Since Spanish is also a Latin language, studying Spanish will provide insights into English vocabulary. Similarly, both Spanish and English share Indo-European roots, so their grammars are similar. The learning of English grammar is enhanced by studying the grammar of another language, for the study forces you to think about how your language is structured. It is not unusual, for example, to gain an understanding of English verb tenses and moods by learning how those verbs are used in Spanish.

- *Knowing our neighbors:* Many Canadians are of Spanish-speaking origin. Knowing Spanish enhances our opportunities to communicate with our neighbours.
- *Cultural understanding:* Knowing another language gives us a window into that culture's way of knowing and being. In our increasingly interdependent and connected global society, cultural understanding is critical.
- *Learning other languages:* If you learn Spanish, you will have a head start in learning the other Latin-based languages such as Portuguese, French, and Italian. Spanish may even help you learn other languages such as Ukrainian and German, since they too have Indo-European roots and have some characteristics (such as gender and extensive conjugation) that are present in Spanish but not English.
- *Spanish literature, the arts, and film:* Spanish also offers a wealth of literature, both modern and traditional. Spanish-language films continue to receive praise from the film industry and viewers. Spanish music, dance, and art forms have influenced contemporary popular and classical culture.
- *Employment opportunities:* Canadian companies and businesses provide services or have subsidiaries in Latin America. The reverse is also true. Many Latin American countries are important trading partners with Canada and the United States. Spanish is useful for those planning a career in one of the helping professions and any occupation that involves international trade, communications, or tourism.
- *Travel and tourism:* Because there are so many Spanish-speaking countries and they are relatively easy to travel to, many Canadians frequently visit Spanish-speaking countries. While it is possible to visit Spanish-speaking countries and get by with English only, speaking Spanish provides greater opportunities to meet new people, communicate with local people, and gain insights into the communities and cultures.
- *Easy for English speakers to learn:* Because of its Latin roots, a similar alphabet, and regular pronunciation rules, Spanish is one of the easiest languages for an English speaker to learn. Spelling of Spanish words closely corresponds to their pronunciation. The mastering of Spanish grammar presents a bigger challenge for speakers of English.

The Second/International Language Learner

Language learning is an active process that begins at birth and continues throughout life. Language is acquired at various rates and in different ways throughout a learner's stages of growth, developing progressively according to individual characteristics and criteria. Students enhance their language abilities by applying their knowledge of language in ever new and more complex contexts with ever increasing sophistication. They reflect on and use prior knowledge to extend and enhance their language knowledge and understanding.

Junior/Senior High School Learners

Language and literacy development begins with the child's earliest experiences with language. The development of oral language, reading, writing, viewing, and representing are interrelated processes. Early years learners actively engage in acquiring language and constructing their own understandings of how oral and written language works. Language learning in the early years is fostered through experience and play. Social interaction is also a vital part of the students' social, emotional, intellectual, and linguistic development.

The middle years may be an especially significant and challenging time for both learners and teachers. Myriam Met argues the following:

Middle school students are characterized by a number of developmental changes—physical, social, emotional, and cognitive. These changes and the feelings they bring about have implications for language instruction and learning. Great care should be exercised in activities that require students to generate physical descriptions or comparisons. Students may feel awkward about their appearance, may be reluctant to stand before the class for individual presentations, and should be allowed more sheltered opportunities such as small group or student-teacher interaction. The need for movement necessitates activities that physically engage students. Hands-on materials and manipulatives provide opportunities for movement while addressing the needs of kinesthetic and tactile learners. Group work allows students to move about the room. In middle school classrooms, it is not unusual to see small groups of students stretched out or seated on the floor.

Piaget has suggested that the middle years are the time children move from the stage of concrete to formal operations. How new concepts are acquired will be influenced by maturational development. The difficulty many middle school students experience in mastering abstract grammar concepts may not be as much a reflection of aptitude as of cognitive maturity. These students will benefit more from concrete experiences, such as vocabulary presented through direct experiences, manipulation of real objects, and pictures, all set in a meaningful context. (“Middle Schools” 2–3)

Middle and senior years learners need many of the same classroom and school supports that create a welcoming and motivating learning environment for younger learners. However, there are some significant differences between older second language learners and younger ones. First, there is evidence from brain research that older second language learners use related but different parts of their brain to learn a second language. This suggests a different learning process, one that is more dependent on the student’s first language. Research suggests that older learners are able to “transfer” many first language skills to their second or additional language (Curtiss; Johnson and Newport).

However, their first language will influence skills in the new language in terms of accent, intonation, and other factors. This does not mean that older students will be less able to become proficient in the additional language, only that some aspects of their first or dominant language will carry over into their second language. Equally important is the overall exposure and opportunity to use the language in everyday situations. The more time devoted to language learning the greater the proficiency achieved (Curtain and Pesola).

Factors That Influence Multilingual Development

It is important that teachers and parents recognize that there are a number of personal factors or individual characteristics which affect learners and their capacity to learn an additional language. These factors are beyond the control of the teacher or school, but are important to consider as they are one of the reasons learners will acquire language at different paces. Tracey Tokuhama-Espinosa identifies ten key factors that have an impact on individual learners. The ten key factors include aptitude, timing, motivation, strategy, consistency, opportunity, the linguistic relationship between the languages, siblings, gender, and hand-use. For the purpose of this document we will look at nine of the factors which are most relevant for language learners in high school settings.

Aptitude: Every individual is born with a certain aptitude for different life skills. Aptitude is based on inherited genes. While teachers cannot influence how much aptitude a learner has, they can make the most of what does exist, and shore it up by using the other nine factors.

Timing: This refers to the windows of opportunity in a person's life when second language learning is facilitated by various factors. Research has shown that the preschool years and the period up to approximately age 12 are a particularly important period in children's linguistic development. During this period and especially during the first three years of life, the foundations for thinking, language, vision, attitudes, aptitudes, and other characteristics are laid down. Since 50 percent of the ability to learn is developed in the first years of life and another 30 percent by age eight, early childhood development programs have the opportunity to encourage early learning and development. This does not mean, however, that 50 to 80 percent of one's intelligence, wisdom, or knowledge is formed during early childhood. It simply means that during the first few years of life, children form their main learning pathways in the brain (Bloom). There are six main pathways to the brain. They include learning by sight, sound, taste, touch, smell, and doing (Dryden and Vos). Later in life, everything an individual learns will grow from the information gained during these early years. Between four and seven years old is a wonderful window for learning new languages. Learners who enter Spanish Language and Culture programs with bilingual or multilingual early childhood and school experiences may initially have an advantage or progress more rapidly than monolingual children. The learning of an additional language in the high school years may be more challenging for certain learners. However, it is equally important to recognize that older learners benefit from their increased knowledge and experience of the world, as well as their first language literacy and language skills. Older learners have a more extensive and well-developed range of first language skills which they can apply to their second language learning.

The debate over whether it is better to begin learning a second language at an early age or to wait until students are more mature has not been resolved. There is, however, some evidence in support of starting second language learning early. As indicated earlier there is evidence that there are some differences in the brain processes between learning a second language as a young learner and as an older learner. Students who begin learning at an earlier age have a greater exposure to the language over time. Older learners are more likely to reflect aspects of their first language, especially in their oral production in terms of intonation, register, and rhythm of speech. Although the increased cognitive abilities of older students may, in part, compensate

for the reduced amount of time spent on language learning in the case of late entry, students cannot be expected to attain the same level of skill and knowledge as those who begin in kindergarten or grade one.

Motivation: Learners' preparedness for learning international languages is partially dependent on their motivation, which includes both positive and negative, as well as internal and external factors, such as how a student feels about the language being learned, and the attitude of other significant persons such as parents and peers. A positive relationship with the language teacher facilitates communication and motivates students.

Strategy: In her study, Tracey Tokuhama-Espinosa found that families who had a well-developed plan that provided for good language learning opportunities were more successful in developing bilingual language skills. In a school setting, it is equally important that an effective instructional plan is in place for the implementation of Spanish Language and Culture programs.

Consistency: It is critical that second language learners are exposed to language learning opportunities in a consistent and continuous fashion. In a school setting this translates into the importance of scheduling Spanish Language and Culture programs to provide for well-sequenced and consistent language learning opportunities.

Opportunity: A student may have a great motivation to learn an additional language, but if they do not have the opportunity to practise it in meaningful situations, they will never truly become proficient. It is important that sufficient time be allocated for Spanish Language and Culture programs during the school day. Students and parents can supplement and enhance classroom language learning experiences by seeking out or building opportunities for language learning in the home and in the community, as well as participating in related extra-curricular activities sponsored by schools.

The Linguistic Relationship between Languages: This simply means whether or not the language being learned and those that the learner is already fluent in share a common historical root. For example, German and English share roots, as do the Romance languages, or Latin languages, of Italian, French, Portuguese, Spanish, and Romanisch. If the learner's first language shares roots with the second language, then the second language is easier to learn due to the similarity of grammar, vocabulary, and sound systems and the fact that learners may more easily transfer their first language skills. It is important that teachers be aware of the linguistic diversity present in the classroom and the language skills of students. Such knowledge will enable teachers to respond to learner needs and characteristics much more effectively and will assist in assessing student learning.

Gender: There is evidence that women and men approach language learning from different parts of the brain. Men tend to localize language in the brain to a rather small and specific area and are relatively literal in their appraisal of conversations, whereas women tend to have their language skills spread out over a wider area of the brain, giving greater importance to things such as intonation, facial movements, and body language. Teachers need to consider gender differences in planning for instruction. It is important to use a variety of instructional approaches that respond to diverse student characteristics.

Hand-Use: Most people have their main language area of the brain in the left frontal and parietal lobes, but unexplainably, a small percentage (30%) of those who write with their left hand and 5% of those who write with their right hand may actually have language spread out over a greater area. This is not to say that this special group are better at international languages than others, but rather that they may favour different teaching methods.

While all ten factors affect all learners, they will do so in different ways. Such individuality is what gives researchers and educators awe at the human capacity for language, and what challenges policy makers and administrators to re-think an individual approach to language education.

Brain Research and Second Language Learning

Brain research has provided greater insights into how language learning happens or is processed in the brain and the significance for second language teaching. Researchers have conceptualized the brain as being composed of four distinct elements: the reptile brain, the emotional brain, the “little brain,” and the thinking brain (Jensen; Dryden and Vos; MacLean). The brain stem, sometimes called the reptile brain, controls many of our body’s involuntary functions such as breathing. The mammalian or emotional brain is located in the center of the brain and stores memory. Therefore, *learning is easier if it is made emotional or fun*. In fact, the door to learning is emotion (Jensen; MacLean; Dryden and Vos).

Where does thinking about the language we are learning take place? Our cortex, or thinking brain, includes the motor cortex and the sensory cortex. Within the cortex, there are many kinds of intelligence centers. Harvard psychologist Howard Gardner (*Frames and speech*) has spent many years analyzing the human brain and its impact on education, including language learning. Gardner says that we have several types of intelligence:

Linguistic Intelligence: The ability to read, write, and communicate with words.

Logical-Mathematical Intelligence: The ability to reason and calculate.

Musical Intelligence: The musical ability highly developed by composers and top musicians.

Visual-Spatial Intelligence: The ability to master position in space. This intelligence is used by architects, painters, and pilots.

Visual Intelligence: The ability to memorize visually and use the imagination.

Kinesthetic Intelligence: The physical intelligence used by dancers and athletes.

Social Intelligence: The ability to relate to others, used by salespeople and motivators.

Introspective Intelligence: The ability to know one's inner feelings, wants, and needs.

Natural Intelligence: The ability to learn by exploring nature.

Implications for Language Learning

The implications of brain research and multiple intelligence theory to second language teaching are many.

1. *Learning is experiential:* We learn by engaging in real hands-on activities and tasks.
2. *Learning uses all senses:* Reinforce learning with pictures and sounds, learn by touching, learn by tasting, and learn by smelling (Dryden and Rose).
3. *Learning should be fun:* The more fun it is to learn a language, the more one will want to continue. Learning while playing is an effective way to learn because it creates emotional attachments, and emotion is the door to learning (Jensen; Dryden and Vos; Dryden and Rose).
4. *Learning is best when in a relaxed but challenging state:* Avoid stress. Research shows that 80 percent of learning problems are stress-related (Stokes and Whiteside).
5. *Learning through music and rhythm:* Music is an effective way to learn a new language. Often one can remember the songs learned in early childhood. We do so because lyrics combined with music are easier to learn (Lozanov; Campbell; Brewer and Campbell).

6. *Learning through action:* Learning activities that use the body and the mind together are powerful tools for learning. While traditionally, we encouraged students to sit all day long, we now know that we learn more when we move as we learn. Utilize learning strategies that include physical interaction and encourage students to dance and move to the rhythm when learning a second or third language (Gardner *Frames*; Doman; Dryden and Vos).
7. *Learning by engaging with others:* Having students practise a language by talking to each other over a meal, for example, is a great way to learn (Gardner *Frames*; Dryden and Vos).
8. *Learning by reflecting:* It is important to let children take time to “simmer.” There is a silent stage to language learning. First children absorb the language. Later they begin to speak (Krashen *Fundamentals*).
9. *Learning by linking:* “The more you link, the more you learn” (Vos). Anything can be linked when learning a second language, including numbers and new vocabulary words (Dryden and Vos). For example, link numbers and words in a playful way (Dryden and Rose). Reciting the numbers from one to ten in Spanish in rhythm is an effective way to begin language learning—“*Uno, dos, tres, cuatro, cinco, seis, siete, ocho, nueve, diez.*”
10. *Learning uses the whole world as the classroom:* Real life experiences and situations engage learners, and bring meaning and context to the learning process (Dryden and Vos).

Considerations for Effective Spanish Language and Culture Programs

International language programs are complex and multifaceted, providing a rich environment for the learning of language and culture.

Effective international languages learning environments are those in which

- the individual and collective needs of students are met
- there is a supportive climate that encourages risk-taking and choice
- diversity in learning styles and needs are accommodated
- connections to prior knowledge and experiences are made
- there is exposure to a wide range of excellent models of authentic language
- use of the Spanish language is emphasized
- quality multimedia, print, human, and other resources are available and applied in a supportive, meaningful, and purposeful manner

Spanish Language and Culture programs strive to provide a rich language learning environment, stressing communicative competence, high academic achievement, and enriched cultural experiences that maximize student opportunities for learning.

Time

The amount of time allocated to Spanish Language and Culture courses across western Canada may vary. Generally, these are optional courses or subjects. For the purpose of this document, we have assumed that students at each grade level will experience 110 to 125 hours of classroom-based Spanish language and culture instruction.

If the amount of time is reduced, then the expected level of achievement should be adjusted accordingly.

When planning for instructional time in Spanish Language and Culture programs, administrators and teachers should carefully consider the impact of scheduling on the linguistic development of the students. In the junior high school and high school settings, it is recommended that Spanish Language and Culture language courses be scheduled to ensure maximum continuity of exposure to the language throughout the school year. If students lose contact with the language for long periods of time, whether on a weekly or a yearly basis, added time must be taken to review previously-learned material that may have been forgotten. Students benefit from using the language on a daily basis.

Prior Knowledge

The Spanish Language and Culture Program of Studies assumes that the students will have limited or no previous knowledge of the Spanish language upon entry into the program. In situations where the majority of students do have previous knowledge of the Spanish language, schools may offer an accelerated program or may assess students and plan courses to suit the students' individual needs. In all cases, students' language levels should be assessed and programs adapted when necessary to meet individual language learning needs.

Students who already have a second language, particularly one that is related to the Spanish language, will often learn additional languages more quickly and more easily than those beginning their study of a second language.

Class Groupings

In some situations, students from two grades may have to be combined into one Spanish class. As well, many classrooms will contain students at the same grade level with varying proficiency levels. By organizing the classroom activities around a task or a content-related project, students of different ages and different levels of ability can be accommodated in a single classroom. Although all students will be working on similar tasks or projects, expectations will be different for each grade or sub-group. Careful planning from year to year and across grade levels will ensure that students experience a variety of learning activities on a broad range of topics.

Opportunities for Language Use and Real-Life Applications

Proficiency-based instruction, which focuses on what students can do with what they know, is critical. Classroom activities that engage students in meaningful and purposeful language use should predominate. Reports suggest that in middle schools where proficiency-based approaches are used, a larger and more diverse population of students experience success (Met “Middle Schools”).

Students will be more successful language learners if they have opportunities to use the language for authentic and meaningful communication in a broad range of contexts. In addition, the curriculum supports and encourages the real-life application of language learning through meaningful contact with fluent speakers of Spanish and authentic Spanish texts, such as newspapers, magazines, electronic communications, and multimedia resources.

While it is important to have a rich language environment in the classroom, it is also important to attempt to provide co-curricular and extra-curricular activities during which students have the opportunity to use and develop their Spanish language skills. Such school- and community-sponsored activities as language camps, visits to cultural facilities, pen pals, plays and performances, language clubs, school visits, and exchanges are important. It is also important to encourage students to continue the development of their Spanish-language skills by using the language for personal enjoyment, listening to music, attending Spanish cultural events and performances, and accessing and using self-study resources.

Choice of Topics and Tasks

The choice of learning topics and tasks should be guided by the needs, interests, and daily experiences of the students, as well as the recommended areas of experience. In the curriculum, different areas of experience and themes are suggested as possible organizers to guide the choice of tasks. The recommended areas of experience are reflected in the learning activities which form part of the next section, Achieving the Outcomes.

Language of Instruction

It is expected that classes will take place in the Spanish language in order to maximize exposure to the language. Spanish language should dominate classroom interaction, whether the teacher or the students are speaking. Learners will sometimes use their first language, especially in the early stages of learning, but will move to the Spanish language as they gain more skill and knowledge. There may be some situations where a few minutes of class time will be used for reflection on the learning process in English or for the development of cultural understanding or skills.

Program Support

Effective Spanish Language and Culture programs depend heavily on collaboration among a range of stakeholders. Students, parents and parental organizations, teachers, school administration, central administration, ministries of education, members of the local community, members of Spanish-speaking communities, post-secondary institutions, Spanish cultural institutions, and other stakeholders all play crucial roles in supporting Spanish language programs. Special attention needs to be paid to ensure that the opportunities for collaboration are maximized.

Resources

Planning lessons and assembling resources for the Spanish Language and Culture program means more than finding a good text with accompanying workbook and audiotapes. As much as possible, students should work with all kinds of authentic audio and print materials and resources, including documents and texts that were designed for Spanish speakers as well as materials prepared for second language learners. These resources should also be appropriate for the age, the developmental level, and the linguistic level of the students. Textbooks and materials should set accessible goals that provide learners with a sense of accomplishment and closure.

Other important characteristics of effective learning resources are:

- Materials should be flexible enough to accommodate the diversity found in schools—a variety of learning styles, interests, abilities, attention spans, and backgrounds.
- Activities should reinforce positive aspects of students' self-image.
- Learning should be made concrete through contextualized vocabulary presentations and the extensive use of visuals such as pictured vocabulary, videos, and charts.
- Exercises and activities should include hands-on student involvement, whether through the use of manipulatives or other forms of physical interaction.
- Instructional experiences should emphasize the development of understanding rather than the decontextualized memorization of vocabulary lists and grammar rules.
- Abstract concepts should be made accessible through concrete experience and scaffolding of complex tasks.
- Interaction with peers should be integrated into these materials to provide for the cognitive and social benefits of pair and group work.
- Materials should be seen by students as relevant to their interests. (Met "Middle Schools")

The Role of the Teacher

The teacher is the key to success in the Spanish classroom. Effective teaching demands a broad range of teacher knowledge and skills both in the Spanish language and in second language pedagogy.

Spanish Language and Culture teachers must be proficient speakers of the language, have a good understanding of Spanish culture, and possess a strong background in a variety of second language teaching methodologies. In addition, teachers will benefit from experience, professional development, and expertise in

- responding to diversity in the classroom and using multilevel groupings
- cooperative learning and student-centred learning
- multi-media and computer-assisted learning
- resource-based language learning

Teachers should continue to engage in professional development in order to maintain or improve their proficiency in the Spanish language and keep their teaching skills current.

The classroom climate created by the teacher cannot be over-emphasized. Students will respond positively to an encouraging teacher and a warm, supportive, and accepting learning environment. Clear expectations and strong classroom management skills are necessary to allow students to perform to their potential.

Student Motivation

When students value their learning, believe they can succeed, and feel in control of the learning process, they develop motivation, or the desire to learn. Teachers can foster students' motivation to learn by

- instilling in each student a belief that s/he can learn
- helping students become aware of their own learning processes, and teaching them strategies for monitoring and enhancing these processes
- assigning tasks and materials of appropriate difficulty, and making sure that students receive the necessary instruction, modelling, and guided practice to be successful
- communicating assessment processes clearly so that students understand the criteria by which progress and achievement are measured
- helping students set realistic goals to enhance their learning
- helping students celebrate their own and classmates' learning progress and achievements within the school community and the broader community
- ensuring that instruction is embedded in meaningful learning events and experiences
- modelling personal enjoyment of Spanish language learning, and communicating the value of learning another language for later success in the world beyond the classroom
- involving students in the choice of themes, topics, resources, and activities around which learning experiences will take place, to foster a sense of ownership
- creating inclusive, risk-free classroom communities where curiosity is fostered and active involvement in the learning process is valued and shared
- providing uninterrupted time for sustained engagement with appropriate Spanish print and non-print resources
- providing collaborative learning experiences that enable students to exchange ideas and perspectives, develop a sense of purpose, and build a sense of community

The Physical Environment

The Spanish Language and Culture classroom is the main instructional area in the school where Spanish language teaching and learning occur. Its size, design, and contents should be able to accommodate a variety of language learning activities. Of course, a permanent location is preferred whether it is a special language room shared by several teachers or the Spanish teacher's own classroom. This will provide learners with a sense of stability and familiarity; reduce the Spanish teacher's preparation time, as all materials can be displayed in the classroom as necessary and stored in one location; and eliminate the inconvenience of transporting instructional materials. The physical layout of the room is best determined by the Spanish Language and Culture teacher.

Notes

ACHIEVING THE OUTCOMES

Contents	3
Guide to Reading the Columns	3
Integration of Outcomes	4
Create a Context for Using Specific Outcomes	5
Use Outcomes and Strategies Recursively	5
The Four General Outcomes	5
Year 1	
Year 2	
Year 3	
Year 4	
Year 5	
Year 6	

ACHIEVING THE OUTCOMES

Contents

The *Spanish Language and Culture Implementation Manual* identifies the prescribed general and specific outcomes by grade from the first to the sixth year. In addition, it provides suggestions for instruction, assessment, and the selection of learning resources to assist educators as they work with students to achieve the prescribed outcomes.

Guide to Reading the Columns

The General Outcome, which is the same from the first to the sixth year, is listed at the top of the first page.

Column one on each page cites the heading for a cluster of specific outcomes in bold print, and the heading for the specific outcome in italics. The specific outcome is highlighted by an asterisk.

Column two includes examples of teaching and learning activities that help to illustrate the intent of the specific outcome, under the heading **Suggestions for Instruction**. Spanish language samples of student materials related to the specific outcome may be included.

Column three includes suggestions for classroom assessment under the heading **Suggestions for Assessment**.

Column four provides suggestions for resources that Spanish Language and Culture program teachers have used or reviewed in the development of this document and in their classrooms. These resources are listed under the heading **Suggested Learning Resources**. All resources listed can be found in either the References section of this document or in Appendix C found on page Appendices – 13. Further information on some of these resources can be found in the annotated bibliography of learning resources found at <<http://www.edu.gov.mb.ca/ks4/learnres/spanish/sp7-S4com2000-2003.pdf>>.

Applications • YEAR 1 SPANISH LANGUAGE AND CULTURE (SIX-YEAR PROGRAM)		YEAR 1 SPANISH LANGUAGE AND CULTURE (SIX-YEAR PROGRAM) • Applications	
PRESCRIBED OUTCOMES	SUGGESTIONS FOR INSTRUCTION	SUGGESTIONS FOR ASSESSMENT	SUGGESTED LEARNING RESOURCES
<p>1.2 express emotions and personal perspectives (continued)</p> <p>1.2.2 <i>Share Emotions, Feelings</i></p> <ul style="list-style-type: none"> ✦ respond to and express emotions and feelings (e.g., pleasure, happiness [estar + adjective]) <p>1.3 get things done</p> <p>1.3.1 <i>Guide Actions of Others</i></p> <ul style="list-style-type: none"> ✦ indicate basic needs and wants ✦ give and respond to simple oral instructions or commands (e.g., ¿Tienes un lápiz?) ✦ ask for permission <p>1.3.2 <i>State Personal Actions</i></p> <ul style="list-style-type: none"> ✦ respond to offers, invitations, and instructions ✦ ask or offer to do something 	<p>► Provide students with charts of faces and emotions written below. Organize students into teams. A student must act out the emotion in the form of a charade and the members of his or her team must guess the emotion being portrayed (e.g., <i>triste, feliz</i>, etc.).</p> <p>Provide students with sentences which they must complete.</p> <ul style="list-style-type: none"> • Cuando estoy triste, yo _____. • Cuando estoy feliz, yo _____. <p>Have students share their results with a partner.</p> <p>► Post basic classroom expressions up in the classroom, using sentences and pictures. Invite students to refer to these expressions when making requests or giving instructions:</p> <ul style="list-style-type: none"> • ¿Puedo ir al baño? • ¿Puedo tener un papel? • Pasa el bolígrafo. • Cierra la puerta. • Escribe tu nombre. <p>► Prepare cards with one simple action related to class activities (verb) written on each card. One student mimes the action for the other members of the class. The class members must guess the action. The student who has mimed the action must then conjugate the verb (e.g., <i>La profesora habla español. Yo voy al baño. Tu escribes en el papel.</i>).</p>	<p>► As students mime emotions, observe their ability to</p> <ul style="list-style-type: none"> • dramatize the emotion • correctly identify the emotion associated with a particular mime <p>Prepare a checklist using observation criteria above.</p> <p>► Observe students and look for evidence that they are able to make appropriate requests in the classroom, school, etc.</p> <p>► As students mime actions, look for evidence that they are able to</p> <ul style="list-style-type: none"> • dramatize the verbs • describe the action in Spanish 	<p>Poster Pals <www.posterpals.ca></p> <p>¡Dimel Uno Unidad 4, Lección 1</p> <p>¡Dimel Uno Unidad 1, Lección 2</p> <p>¡Buen Viaje! 1A Capítulo 1</p> <p>¡En español! Etapa preliminar Frases útiles</p> <p>VERBingo Interactive Kit</p> <p>¡Viva el Español!: ¡Hola! Resource and Activity Book Vocabulary Cards Masters 34-96</p>

Integration of Outcomes

The Spanish Language and Culture documents (*Framework and Implementation Manual*) assume that the general and specific outcomes will be delivered in an integrated manner, even though the curriculum document itself is divided into numbered sections. Although the *Spanish Language and Culture, Six-Year Junior/Senior High School Program: Implementation Manual* contains four-column sections, the four-column section treats each specific learning outcome separately to provide suggestions specific to that learning outcome. In the classroom, single outcomes are rarely taught in isolation. Effective integrated Spanish Language and Culture learning experiences typically address many outcomes simultaneously. Teaching vocabulary or grammar points in isolation is not an effective method. Activities designed to develop specific skills related to the form of the language should always be embedded in meaningful contexts where students will see the purpose for learning the skill and will have immediate opportunities to use the particular form in their own productions.





Create a Context for Using Specific Outcomes

The specific outcomes listed in the four columns are not intended to be taught in the order in which they are written. Teachers are encouraged to select specific outcomes, both within a general outcome and across all four general outcomes, and to organize these outcomes into logical sequences for instructional activities. Spanish Language and Culture instruction and assessment should always occur within meaningful literacy contexts. Teachers develop authentic instruction and assessment focused on specific outcomes while developing themes, inquiries, genre studies, projects, tasks, and other learning experiences.

Use Outcomes and Strategies Recursively

Many aspects of language arts are recursive and need to be revisited repeatedly through the use of a variety of materials and strategies. Questioning, for example, can be used repeatedly in many different contexts. Outcomes can be introduced using one strategy, and then revisited and extended, using different strategies or different topics, until students have achieved the particular outcomes.

The Four General Outcomes

<p style="text-align: center;">Applications</p>  <p>Students will use Spanish in a variety of situations and for a variety of purposes to</p> <ul style="list-style-type: none"> • impart and receive information • express emotions and personal perspectives • get things done • extend their knowledge of the world • use the language for imaginative purposes and personal enjoyment • form, maintain, and change interpersonal relationships 	<p style="text-align: center;">Language Competence</p>  <p>Students will use Spanish effectively and competently to</p> <ul style="list-style-type: none"> • attend to form • interpret and produce oral texts • interpret and produce written texts • apply knowledge of the sociocultural context • apply knowledge of how text is organized, structured, and sequenced
<p style="text-align: center;">Global Citizenship</p>  <p>Students will acquire the knowledge, skills, and attitudes to be effective global citizens, through the exploration of the cultures of the Spanish-speaking world to</p> <ul style="list-style-type: none"> • study historical and contemporary elements of Spanish-speaking cultures • affirm diversity • explore personal and career opportunities 	<p style="text-align: center;">Strategies</p>  <p>Students will know and use various strategies to maximize the effectiveness of learning and communication:</p> <ul style="list-style-type: none"> • language learning strategies • language use strategies • general learning strategies

Applications

Students will use Spanish in a variety of situations and for a variety of purposes.

The specific outcomes under the heading Applications deal with **what** the students will be able to do with the Spanish language, that is, the **functions** they will be able to perform and the **contexts** in which they will be able to operate. This functional competence, also called actional competence, is important for a content-based or task-based approach to language learning where students are constantly engaged in meaningful tasks (Celce-Murcia, Dörnyei, and Thurrell).

Different models of communicative competence have organized language functions in a variety of ways. The organizational structure chosen here reflects the needs and interests of students in a classroom where activities are focused on meaning and are interactive. For example, the strand entitled **manage group actions** has been included to ensure that students acquire the language necessary to function independently in small groups, since this is an effective way of organizing second language classrooms. The strands under the cluster heading **to extend their knowledge of the world** will accommodate a content-based approach to language learning where students learn content from another subject area as they learn the Spanish language.

The level of linguistic, sociolinguistic, and discourse competence that students will exhibit when carrying out the functions is defined in the specific outcomes for Language Competence for each course. To know how well students will be able to perform the specific function, the Applications outcomes must be read in conjunction with the Language Competence outcomes.

Language Competence

Students will use Spanish effectively and competently.

Language competence is a broad term that includes linguistic or grammatical competence, discourse competence, sociolinguistic or sociocultural competence, and what might be called textual competence. The specific outcomes under Language Competence deal with knowledge of the Spanish language and the ability to use that knowledge to interpret and produce meaningful texts appropriate to the situation in which they are used. Language competence is best developed in the context of activities or tasks where the language is used for real purposes, in other words, in practical **applications**.

Although the outcomes isolate individual aspects, language competence should be developed through learning activities that focus on meaningful uses of the Spanish language and on **language in context**. Tasks will be chosen based on the needs, interests, and experiences of students. The vocabulary, grammar structures, text forms, and social conventions necessary to carry out a task will be taught, practised, and assessed as students are involved in various aspects of the task itself, **not in isolation**.

Strategic competence is often closely associated with language competence, since students need to learn ways to compensate for low proficiency in the early stages of learning if they are to engage in authentic language use from the beginning. This component is included in the language use strategies in the Strategies section.

Global Citizenship

Students will acquire the knowledge, skills, and attitudes to be effective global citizens, through the exploration of the cultures of the Spanish-speaking world.

The outcomes for Global Citizenship deal with a broad range of knowledge, skills, and attitudes needed to be effective global citizens—in other words, with the development of intercultural competence. The concept of global citizenship encompasses citizenship at all levels, from the local school and community to Canada and the world.

Developing cultural knowledge and skills is a lifelong process. Knowledge of one's own culture is acquired over a lifetime. Cultures change over time. Within any national group, there may be a dominant culture or cultures and a number of minority cultures. Rather than try to develop an extensive bank of knowledge about the Spanish-speaking cultures, it is more important for students to learn the processes and methods of accessing and analyzing cultural practices. Students will gain cultural knowledge in the process of developing these skills. In this way, if they encounter elements of the Spanish-speaking cultures they have not learned about in class, they will have the skills and abilities to deal with them effectively and appropriately.

The **affirm diversity** heading covers knowledge, skills, and attitudes

that are developed as a result of bringing other languages and cultures into relationship with one's own. There is a natural tendency, when learning a new language and culture, to compare it with what is familiar. Many students leave a second language learning experience with a heightened awareness and knowledge of their own language and culture. They will also be able to make some generalizations about languages and cultures based on their experiences and those of their classmates who may have a variety of cultural backgrounds. This will provide students with an understanding of diversity within both a global and a Canadian context.

Strategies

Students will know and use various strategies to maximize the effectiveness of learning and communication.

Under the Strategies heading are specific outcomes that will help students learn and communicate more effectively. Strategic competence has long been recognized as an important component of communicative competence. The outcomes that follow deal not only with compensation and repair strategies, important in the early stages of language learning when proficiency is low, but also with strategies for language learning, language use in a broad sense, as well as general learning strategies that help students acquire content. Although people may use strategies unconsciously, the outcomes deal only with the conscious use of strategies.

The strategies that students choose depend on the task they are engaged in as well as on other factors, such as their preferred learning style, personality, age, attitude, and cultural background. Strategies that work well for one person may not be effective for another person or may not be suitable in a different situation. For this reason it is not particularly useful to say that students should be aware of, or able to use, a specific strategy in a particular course. Consequently, the specific outcomes describe the students' knowledge of and ability to use general types of strategies. The specific strategies provided in the suggested activity are not prescriptive but are provided as an illustration of how the general strategies in the specific outcomes might be developed.

Teachers need to know and be able to demonstrate a broad range of strategies from which students are then able to choose in order to communicate effectively. Strategies of all kinds are best taught in the context of learning activities where students can apply them immediately and then reflect on their use.

YEAR 1

Applications	3
Language Competence	23
Global Citizenship	51
Strategies	67
Appendices	77

APPLICATIONS
YEAR 1



Applications

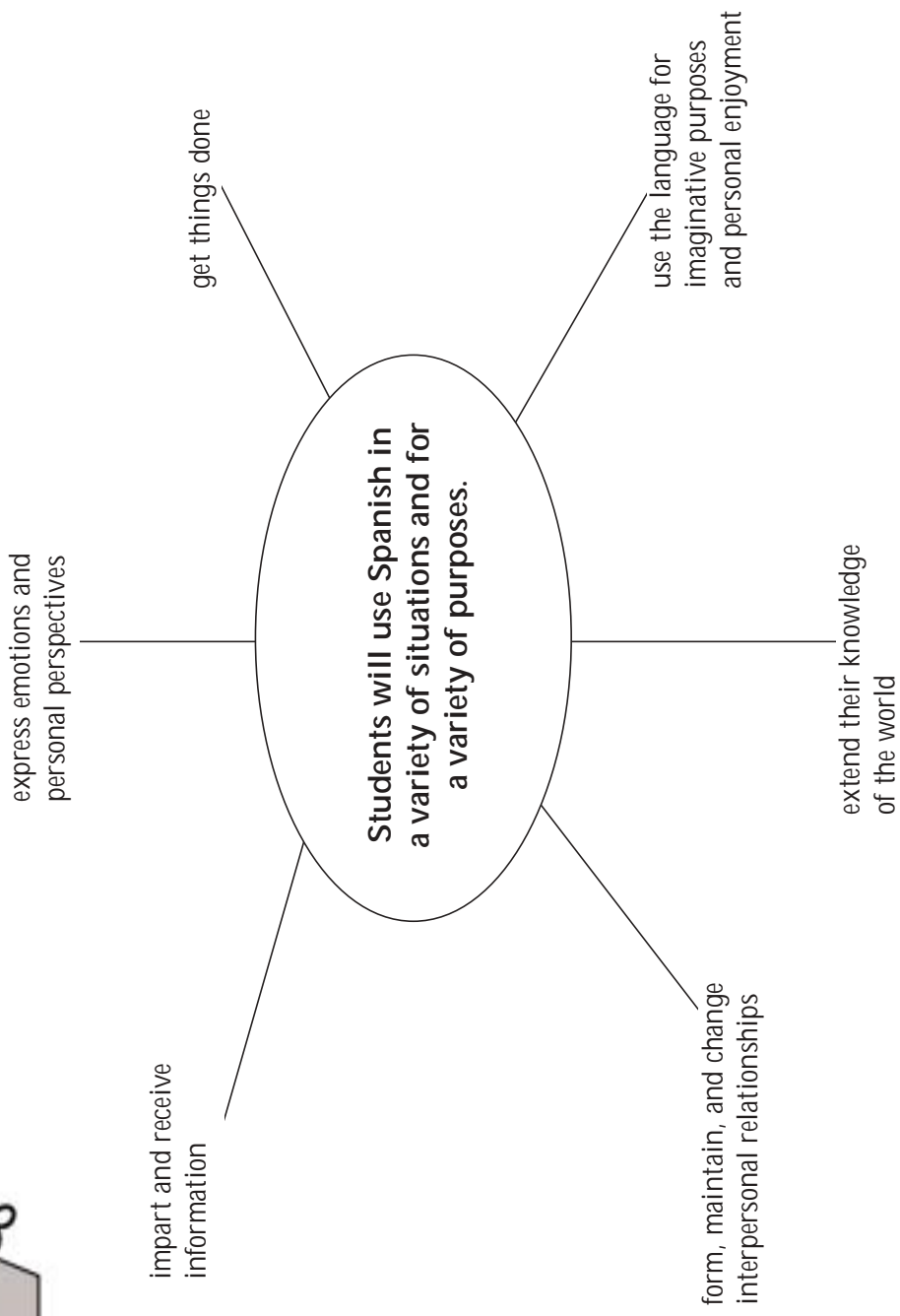
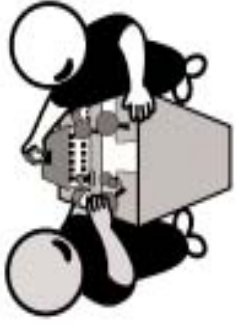



APPLICATIONS

General Outcome 1: Students will use Spanish in a variety of situations and for a variety of purposes.

The specific outcomes under the heading Applications deal with **what** the students will be able to do with the Spanish language, that is, the **functions** they will be able to perform and the **contexts** in which they will be able to operate. This functional competence, also called actional competence, is important for a content-based or task-based approach to language learning where students are constantly engaged in meaningful tasks (Celce-Murcia, Dörnyei, and Thurrell).

The functions are grouped under six cluster headings—see the illustration on the preceding page. Under each of these headings, there are one or more strands. Each strand deals with a specific language function (e.g., share factual information). Students at any grade level will be able to share factual information. Beginning learners will do this in very simple ways (e.g., “This is my dog.”). As students gain more knowledge and experience, they will broaden the range of subjects they can deal with, they will learn to share information in writing as well as orally, and they will be able to handle formal and informal situations.

Different models of communicative competence have organized language functions in a variety of ways. The organizational structure chosen here reflects the needs and interests of students in a classroom where activities are focused on meaning and are interactive. For example, the strand entitled **manage group actions** has been included to ensure that students acquire the language necessary to function independently in small groups, since this is an effective way of organizing second language classrooms. The strands under the cluster heading **to extend their knowledge of the world** will accommodate a content-based approach to language learning where students learn content from another subject area as they learn the Spanish language.

The level of linguistic, sociolinguistic, and discourse competence that students will exhibit when carrying out the functions is defined in the specific outcomes for Language Competence for each course. To know how well students will be able to perform the specific function, the Applications outcomes must be read in conjunction with the Language Competence outcomes.



PRESCRIBED OUTCOMES
<p>General Outcome 1: Applications</p> <p>Students will use Spanish in a variety of situations and for a variety of purposes.</p> <p>1.1 impart and receive information</p> <p>1.1.1 <i>Share Factual Information</i></p> <ul style="list-style-type: none"> ❖ share basic information (e.g., their name) ❖ identify concrete people, places, things

SUGGESTIONS FOR INSTRUCTION

- Have students form two circles, one inside the other. With music playing, ask one circle to walk in one direction and the other to walk in the opposite direction. When the music stops, have students interview the classmate opposite them, using familiar patterns such as the following (BC *Resource Package*, 12)*:
 - ¿Cómo te llamas? Yo me llamo _____ y tú?
 - ¿Cuántos años tienes? Tengo _____ años, y tú?
 - ¿Cómo estás? Estoy _____
- Have students in pairs use pre-framed models to dramatize situations in which they need to provide specific information, real or fictitious. For example, ask students to imagine that they are arriving at a border crossing where they must provide information required to have their passports stamped (BC *Resource Package*, 20).
- Play *Information Search*. Ask students to complete a questionnaire related to simple personal information

Busca a una persona	Firma
¿Tienes un hermano?	_____
¿Tienes una bicicleta?	_____
¿Tienes una computadora?	_____
- *Variation*: Use pictures instead of words for “Busca a una persona” (e.g., ¿Tienes una _____?) (BC *Resource Package*, 20)

* Reprinted (or adapted) from the *Spanish 5 to 12 Integrated Resource Package* (1997). Used with permission of the Ministry of Education, Province of British Columbia. All future references to BC *Resource Package* fall under this permission statement.

(continued)



SUGGESTIONS FOR ASSESSMENT

SUGGESTED LEARNING RESOURCES

- When students exchange information using familiar Spanish patterns, look for evidence that they recognize, use, and respond to simple patterns or questions.

- When students exchange specific information (e.g., as they dramatize arriving at a border crossing), look for evidence that they are able to
 - use the patterns and frames with less and less support
 - make themselves understood
 - complete the activity using only Spanish

- Observe students during the Information Search and look for evidence that they
 - ask and respond to questions
 - understand and use accurate vocabulary

¡En español! 1
pp. 4, 5

¡Buen Viaje! 1A
Lección Preliminar

Chicos Chicas Nivel 1
Unidad 1, Lección 1 and 2

¡Viva el Español!: ¡Hola!
Unidad 1, Lección 1

¡Buen Viaje! 1B
Capítulo 11

¡En español! 1
Unidad 1, Etapa 3
Actividad 16 and 18

¡Viva el Español!: ¡Hola!
Resource and Activity Book
Vocabulary Review
Masters 97–106



PRESCRIBED OUTCOMES	SUGGESTIONS FOR INSTRUCTION
<p>1.1 impart and receive information (continued)</p> <p>1.1.1 <i>Share Factual Information (continued)</i></p> <ul style="list-style-type: none">❖ share basic information (e.g., their name)❖ identify concrete people, places, things	<ul style="list-style-type: none">➤ Put the name of each student on an index card. Prepare a list of basic questions or questions about personal information (e.g., <i>¿Cuál es tu apellido? ¿Dónde vives?</i>). Each day ask a few students three to five of these basic questions.➤ Invite students to interview classmates about their birthdates. Then ask students in small groups to record the dates in calendars to be displayed in the classroom (BC <i>Resource Package</i>, 28).➤ Have students prepare a personal coat of arms that might include name, birthdate, place of birth, family members, etc. Have students use drawings within their coat of arms and display in the classroom.
<p>1.2 express emotions and personal perspectives</p> <p>1.2.1 <i>Share Ideas, Thoughts, Opinions, Preferences</i></p> <ul style="list-style-type: none">❖ express simple preferences (e.g., <i>Me gusta la clase de español. No me gusta la clase de matemáticas</i>)❖ express a personal response (e.g., respond to a song or story)	<ul style="list-style-type: none">➤ Suggest that students form pairs and that each pair draw a circle on a large sheet of paper and then draw a line down the centre of it. Invite students to list their own likes on one half of their circles and their own dislikes on the other. Have pairs discuss their choices. Encourage students to use drawings, previously learned language patterns, and vocabulary to indicate these choices (BC <i>Resource Package</i>, 12). <p><i>Variation:</i> Have students use a Venn Diagram, identifying their own likes and dislikes, as well as shared likes and dislikes.</p>



SUGGESTIONS FOR ASSESSMENT

SUGGESTED LEARNING RESOURCES

- Prepare a simple scoring scale out of 3 points for the responses to basic questions:
 - 1/3 Student responds with a word or words
 - 2/3 Student responds in a complete sentence, but with grammatical errors
 - 3/3 Students responds in a complete, grammatically correct sentence

(See examples of scoring scales in Classroom Assessment, p. 13.)

- After students have completed their coat of arms, students should be able to respond to written and oral questions about their coat of arms:
 - ¿Cuál es tu nombre?
 - ¿Cuándo es tu cumpleaños?

Prepare a checklist with questions such as the following:

- Does the student respond to simple predictable questions?
- Does the student comprehend the questions asked?

- Observe students' ability to
 - express common likes and dislikes
 - use gestures, drawings, and simple vocabulary to convey meaning
 - use Spanish language related to grade 7 themes (e.g., ¿Te gusta? Sí, me gusta/No, no me gusta)

¡Buen Viaje! 1

Preliminar D

Chicos Chicas, Nivel 1

Unidad 1, Lección 1

Chicos Chicas, Nivel 1

Unidad 1, Lección 2

¡En español!

Etapa Preliminar

Unidad 1, Etapa 3

¡Dime! Uno

Unidad 4, Lección 1

¡En español! 1A

Unidad 1, Etapa 2

Actividad 3

¡En español! 1A

Unidad 1, Etapa 1

Actividad 19, 20



PRESCRIBED OUTCOMES	SUGGESTIONS FOR INSTRUCTION
<p>1.2 express emotions and personal perspectives (continued)</p> <p>1.2.1 <i>Share Ideas, Thoughts, Opinions, Preferences (continued)</i></p> <ul style="list-style-type: none">❖ express simple preferences (e.g., <i>Me gusta la clase de español. No me gusta la clase de matemáticas</i>)❖ express a personal response (e.g., respond to a song or story)	<p>➤ As a class, brainstorm activities in which students participate outside of school. Have students in small groups conduct surveys of their favourite activities and interests, using pre-framed Spanish sentence structure. For example: <i>¿Cuál es tu _____ favorito/a?</i> (<i>video, comida, deporte, color</i>) (BC Resource Package, 28)</p> <p>➤ Using pictures from magazines that depict a variety of activities, ask students which activities they like or don't like. Use the expression: <i>¿Te gusta _____?</i> <i>¿No te gusta _____?</i></p> <p>Introduce intensifiers such as "<i>muchísimo, mucho.</i>" As an extension, have students draw two or three of their own favourite activities and then work in pairs or small groups, asking the question, <i>¿Te gusta _____?</i></p>



SUGGESTIONS FOR ASSESSMENT

- As students interact in collecting information for their surveys, look for evidence that they
 - are developing a variety of vocabulary for different activities (language competence, lexicon)
 - recognize familiar words and patterns
 - attempt to respond in simple sentences rather than single words (language competence, oral production)

When students present their surveys, prepare a rubric using criteria below:

 - speak clearly (language competence, oral production)
 - use approximate Spanish pronunciation and intonation (language competence, phonology)
 - use a variety of vocabulary related to leisure activities (language competence, lexicon)

- When students are interacting, use an oral observation rubric to assess students using criteria such as
 - use the verb "*gustar*" correctly
 - use intensifiers modelled in class that students have identified themselves

(See oral scoring scales examples in Classroom Assessment, p. 11.)

SUGGESTED LEARNING RESOURCES

¡Dime! Uno
Unidad 3, Lección 1

¡Buen Viaje! 1
Capítulo 4
Expansion activities with TPR storytelling

Chicos Chicas, Nivel 1
Unidad 3, Lección 6
Unidad 7, Lección 13



PRESCRIBED OUTCOMES	SUGGESTIONS FOR INSTRUCTION
<p>1.2 express emotions and personal perspectives (continued)</p> <p>1.2.2 <i>Share Emotions, Feelings</i></p> <ul style="list-style-type: none">❖ respond to and express emotions and feelings (e.g., pleasure, happiness [<i>estar</i> + adjective])	<p>➤ Provide students with charts of faces and emotions written below. Organize students into teams. A student must act out the emotion in the form of a charade and the members of his or her team must guess the emotion being portrayed (e.g., <i>triste, feliz</i>, etc.).</p> <p>Provide students with sentences which they must complete.</p> <ul style="list-style-type: none">• <i>Cuando estoy triste, yo _____ .</i>• <i>Cuando estoy feliz, yo _____ .</i> <p>Have students share their results with a partner.</p>
<p>1.3 get things done</p> <p>1.3.1 <i>Guide Actions of Others</i></p> <ul style="list-style-type: none">❖ indicate basic needs and wants❖ give and respond to simple oral instructions or commands (e.g., <i>¿Tienes un lápiz?</i>)❖ ask for permission	<p>➤ Post basic classroom expressions up in the classroom, using sentences and pictures. Invite students to refer to these expressions when making requests or giving instructions:</p> <ul style="list-style-type: none">• <i>¿Puedo ir al baño?</i>• <i>¿Puedo tener un papel?</i>• <i>Pasa el bolígrafo.</i>• <i>Cierra la puerta.</i>• <i>Escribe tu nombre.</i>
<p>1.3.2 <i>State Personal Actions</i></p> <ul style="list-style-type: none">❖ respond to offers, invitations, and instructions❖ ask or offer to do something	<p>➤ Prepare cards with one simple action related to class activities (verb) written on each card. One student mimes the action for the other members of the class. The class members must guess the action. The student who has mimed the action must then conjugate the verb (e.g., <i>La profesora habla español. Yo voy al baño. Tú escribes en el papel.</i>).</p>



SUGGESTIONS FOR ASSESSMENT

SUGGESTED LEARNING RESOURCES

- As students mime emotions, observe their ability to
 - dramatize the emotion
 - correctly identify the emotion associated with a particular mime
 Prepare a checklist using observation criteria above.

Poster Pals
 <www.posterpals.ca>
¡Dime! Uno
 Unidad 4, Lección 1

- Observe students and look for evidence that they are able to make appropriate requests in the classroom, school, etc.

¡Dime! Uno
 Unidad 1, Lección 2
¡ Buen Viaje! 1A
 Capítulo 1
¡En español!
 Etapa preliminar
 Frases útiles

- As students mime actions, look for evidence that they are able to
 - dramatize the verbs
 - describe the action in Spanish

VERBingo
 Interactive Kit
¡Viva el Español!: ¡Hola!
Resource and Activity Book
 Vocabulary Cards
 Masters 34–96



PRESCRIBED OUTCOMES	SUGGESTIONS FOR INSTRUCTION
<p>1.3 get things done (continued)</p> <p>1.3.3 <i>Manage Group Actions</i></p> <ul style="list-style-type: none">❖ manage turn-taking❖ encourage other group members to act appropriately	<p>➤ Organize students into groups of four. Provide students with a very simple text to read. After the reading of the text, one person in the group asks prepared questions about the text. The second person answers the questions. The third person represents the answers visually. The fourth person makes corrections or additions to the answers.</p> <p><i>Variation:</i> Present each group a list of questions related to a theme being studied. One person asks one question, the next person responds, the third person represents the answer visually, and the fourth person makes modifications to the answer. Students then change roles for the next question.</p> <p>➤ Organize a group activity in which students take turns or take on specific roles that they must negotiate amongst themselves using cards with visual imagery (e.g., Go Fish—“¿Tienes un gato?” “No, anda a pescar.”).</p>
<p>1.4 extend their knowledge of the world</p> <p>1.4.1 <i>Discover and Explore</i></p> <ul style="list-style-type: none">❖ investigate the immediate environment (e.g., use kinaesthetic, spatial, musical abilities)❖ ask simple questions	<p>➤ Invite students to conduct simple interviews in pairs, using simple questions (e.g., ¿Cómo te llamas? ¿Cuál es tu número de teléfono? ¿Cuál es tu dirección?, etc.). Students may choose to play the part of an imaginary or famous person.</p> <p><i>Variation:</i> Have students work in pairs to ask each other simple questions related to Grade 7 themes (e.g., ¿Dónde está Perú?, etc).</p>



SUGGESTIONS FOR ASSESSMENT

SUGGESTED LEARNING RESOURCES

- As students work in groups, look for evidence that they
 - use accurate vocabulary related to roles and turn-taking (language competence, lexicon)
 - use Spanish when talking about turn-taking

Easy Spanish readers
¡En grupos!
 Sección: Cultura

- When students work in pairs to ask simple questions, look for evidence that they
 - ask questions using appropriate intonation
 - respond to questions appropriately
 - use appropriate pronunciation

Das Mundos
 Student Edition
Chicos Chicas, Nivel 1



PRESCRIBED OUTCOMES	SUGGESTIONS FOR INSTRUCTION
<p>1.4 extend their knowledge of the world</p> <p>1.4.2 <i>Gather and Organize Information</i></p> <ul style="list-style-type: none">❖ gather simple information❖ organize items in different ways <p>1.4.3 <i>Solve Problems</i></p> <ul style="list-style-type: none">❖ experience problem-solving situations in the classroom (e.g., in stories) <p>1.4.4 <i>Explore Opinions and Values</i></p> <ul style="list-style-type: none">❖ listen attentively to the opinions expressed❖ respond sensitively to the ideas and products of others	<p>➤ Invite students to complete a variety of forms that require basic information (e.g., passport application, library card application, etc.).</p> <p>➤ Have students listen to a simple story, view a short video sequence, or examine a scrambled comic strip. Then have students work in pairs or in small groups to put the main events of the story into the correct sequence. Students could use simple words or drawings to depict the story.</p> <p>➤ Provide students with scenarios of simple school problems. In groups or as a class, students respond to guided questions related to the scenario and arrive at a possible solution.</p> <p>➤ Provide students with a simple text in which characters express opinions. Have students agree or disagree with the opinions of the text.</p>



SUGGESTIONS FOR ASSESSMENT

SUGGESTED LEARNING RESOURCES

- As students complete forms, look for evidence that they are able to
 - gather relevant simple information
 - organize the information in different ways

- When students sequence the events of a story, look for evidence that they are able to
 - put the story in a logical sequence
 - use drawings and simple vocabulary effectively to depict the sequence of events
 - present the sequence of events in simple sentences, with the aid of the drawings and vocabulary

- As students work through scenarios of simple school problems, look for evidence that they are able to
 - identify the problem
 - propose possible solutions
 - work cooperatively to discuss possible solutions and to choose a solution
 - show respect towards others' preferences

- As students work through the activity, look for evidence that they are
 - actively listening
 - expressing disagreement respectfully

¡Buen Viaje! 1A
 Capítulo 3
 Culminación, Actividad C

Planet@ 1
 Tema 1
 pp. 21 and 27

¡En español! 1
 Unidad 2, Etapa 1

¡Viva el Español!: ¡Hola!
Resource and Activity Book
 Master 30



PRESCRIBED OUTCOMES	SUGGESTIONS FOR INSTRUCTION
<p>1.5 for imaginative purposes and personal enjoyment</p> <p>1.5.1 <i>Humour/Fun</i></p> <ul style="list-style-type: none">❖ identify words or situations that are personally humorous <p>1.5.2 <i>Creative/Aesthetic Purposes</i></p> <ul style="list-style-type: none">❖ participate in creative and aesthetic language activities <p>1.5.3 <i>Personal Enjoyment</i></p> <ul style="list-style-type: none">❖ use the language for personal enjoyment (e.g., listen to a favourite song in Spanish)	<p>➤ Provide students with tongue twisters in Spanish. Allow students time to practice the tongue twisters in pairs or in groups. Students then present the twisters to the class.</p> <p>➤ Provide students with Spanish names, nicknames, cognates, for example, <i>Pancho</i> (Francisco) <i>jonrón</i> (Homerun).</p> <p>➤ Invite each student to compose a poem based on her or his own name or a Spanish name. Explain that each line should be a word or phrase describing a favourite activity or personal quality and should include a letter from the name. An example follows, using the name Pepe (BC <i>Resource Package</i>, 48):</p> <p style="text-align: center;"><i>simPático</i> <i>genEroso</i> <i>me gusta Patinar</i> <i>fuErte</i></p> <p>➤ Using a popular Spanish song, have students replace parts of the lyrics with their own words (e.g., <i>Para bailar la Bamba/Para comer la manzana</i>).</p> <p>➤ Brainstorm with students Spanish language activities that they think would be fun. Have students attempt at least one of the activities identified.</p>



SUGGESTIONS FOR ASSESSMENT

SUGGESTED LEARNING RESOURCES

- When students participate in activities such as tongue twisters, look for evidence that they are able to
 - listen actively to follow instructions
 - model Spanish intonation and pronunciation (language competence, interpret and produce texts)
 - take risks to respond in Spanish
 - participate willingly (strategies, social/affective)

- When students compose a poem based on their names, provide students with a checklist. Criteria might include the following:
 - appropriate adjectives with the correct gender are used
 - the pattern/frame of the poem is maintained
 (See written criteria examples in Classroom Assessment, p. 12.)

- When students replace parts of the lyrics of a Spanish song with their own words, use a checklist. Criteria might include the following:
 - students are engaged in the task
 - chosen words are logical and appropriate (language competence, interpret and product texts)

- ¡En español! 1*
Unidad 5, Etapa 2
Unidad 1, Etapa 1
- ¡Viva el Español!: ¡Hola!*
Appendix

- ¡Dime! Uno*
Unidad 3
- ¡Buen Viaje! 1*
Tape Manual, CD 1
- ¡Viva el Español!: ¿Qué tal?*
Resource and Activity Book
Song cassette (music and lyrics)
- ¡Viva el Español!: ¡Hola!*
Resource and Activity Book
Song cassette (music and lyrics)
- ¡Viva el Español!: ¡Adelante!*
Resource and Activity Book
Song cassette (music and lyrics)

- Chicos Chicas, Nivel 1*
(CD/cassette)
Primer contacto, p. 10, #1
Unidad 1, Lección 2, p. 18, #1
Unidad 2, Lección 2, p. 28 #1



**PRESCRIBED
OUTCOMES**

1.6 form, maintain, and change interpersonal relationships

1.6.1 *Manage Personal Relationships*

- ❖ exchange greetings and farewells
- ❖ address a new acquaintance, and introduce themselves
- ❖ exchange some basic personal information

SUGGESTIONS FOR INSTRUCTION

- Invite students to prepare simple skits/dialogues with greetings, basic information, and closing expressions. Provide students with model dialogues that they can modify to prepare their own dialogues which demonstrate meeting someone new and making an effort to get to know the person.



SUGGESTIONS FOR ASSESSMENT

- When students prepare simple skits/dialogues, look for evidence that they have included
 - greetings
 - basic information
 - closing expressions
 - gestures

SUGGESTED LEARNING RESOURCES

¡En español! 1
 Video, Unidad 1, Etapa 1
 "En vivo"

¡En grupos!
 Capítulo 1

¡Viva el Español!: ¡Hola!
Resource and Activity Book
 ¡A conversar y a leer!
 Blackline Masters 107–116



Notes

*LANGUAGE
COMPETENCE
YEAR 1*



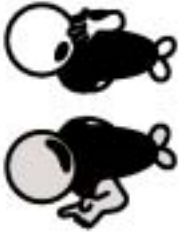

Language Competence

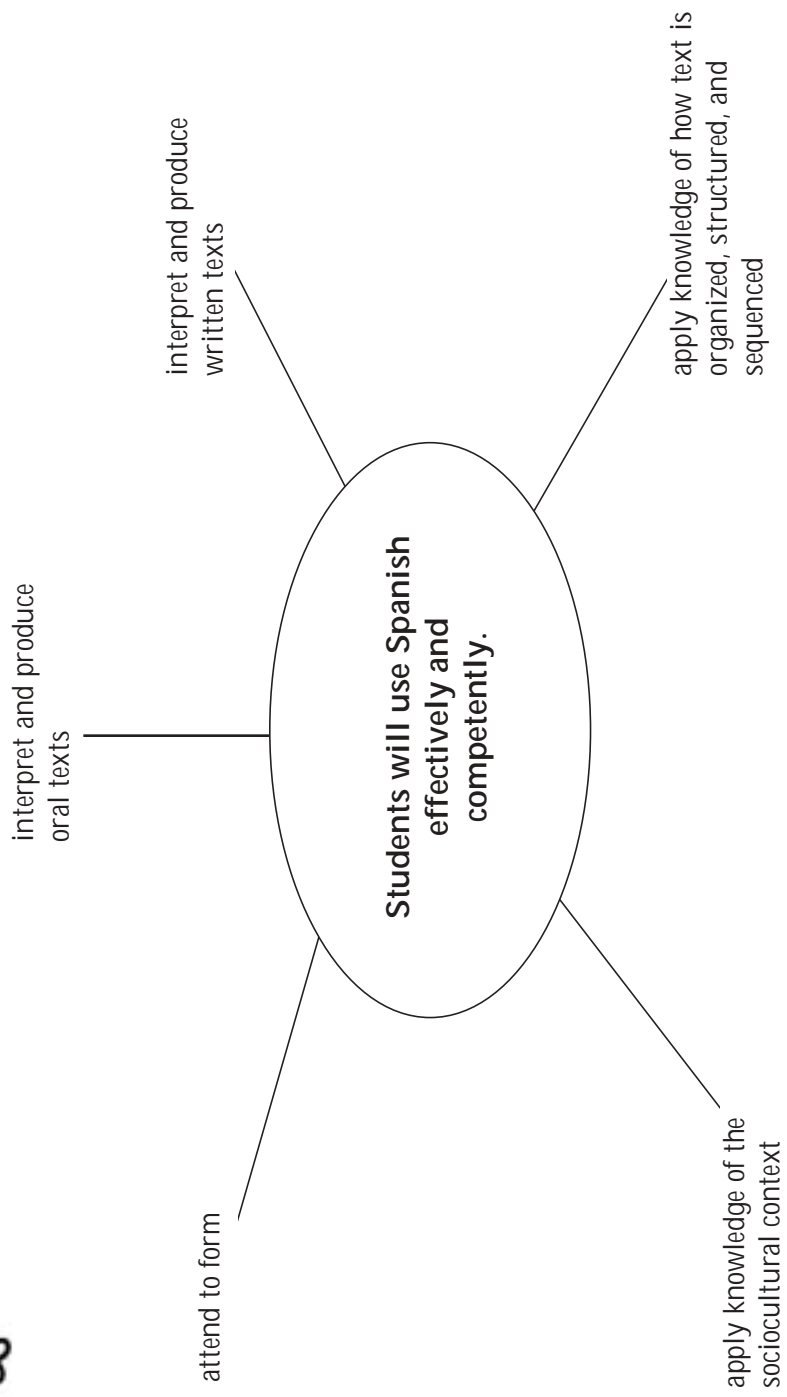



LANGUAGE COMPETENCE

General Outcome 2: Students will use Spanish effectively and competently.

Language competence is a broad term that includes linguistic or grammatical competence, discourse competence, sociolinguistic or sociocultural competence, and what might be called textual competence. The specific outcomes under Language Competence deal with knowledge of the Spanish language and the ability to use that knowledge to interpret and produce meaningful texts appropriate to the situation in which they are used. Language competence is best developed in the context of activities or tasks where the language is used for real purposes, in other words, in practical **applications**.

The various components of language competence are grouped under four cluster headings—see the illustration on the preceding page. Under each of these headings there are several strands. Each strand deals with a single aspect of language competence. For example, under the cluster heading **attend to form**, there is a strand for phonology (pronunciation, stress, intonation), orthography (spelling, mechanical features), lexicon (vocabulary words and phrases), and grammatical elements (syntax and morphology).

Although the outcomes isolate these individual aspects, language competence should be developed through learning activities that focus on meaningful uses of the Spanish language and on **language in context**. Tasks will be chosen based on the needs, interests, and experiences of students. The vocabulary, grammar structures, text forms, and social conventions necessary to carry out a task will be taught, practised, and assessed as students are involved in various aspects of the task itself, **not in isolation**.

Strategic competence is often closely associated with language competence, since students need to learn ways to compensate for low proficiency in the early stages of learning if they are to engage in authentic language use from the beginning. This component is included in the language use strategies in the Strategies section.



PRESCRIBED OUTCOMES	SUGGESTIONS FOR INSTRUCTION
<p>General Outcome 2: Language Competence Students will use Spanish effectively and competently.</p> <p>2.1 attend to form</p> <p>2.1.1 <i>Phonology</i></p> <ul style="list-style-type: none">❖ pronounce some common words and phrases comprehensibly❖ use intonation to express meaning❖ recognize that stress is important for meaning <p>2.1.2 <i>Orthography</i></p> <ul style="list-style-type: none">❖ recognize and name the Spanish letters of the alphabet or characters❖ apply basic punctuation	<p>➤ Have students sit in a circle. Each student reads a word from a list provided. Have students help each other with the pronunciation of the words. As an extension, play a game in which the group gains points each time a word is pronounced correctly.</p> <p>➤ Provide students with a list of basic statements, questions, and exclamations. Model appropriate intonation for each and have students prepare skits using the appropriate intonation of the expressions of the list.</p> <p>➤ Have students invent an ABC song to a melody of their choice in Spanish.</p> <p>➤ Provide students with a list of words and phrases and have them recognize when ¿?, etc. are necessary and explain why.</p>



SUGGESTIONS FOR ASSESSMENT

**SUGGESTED LEARNING
RESOURCES**

- Look for evidence that students are able to
 - demonstrate correct pronunciation
 - monitor classmates' pronunciationPrepare a rubric which states the criteria for pronunciation.

- Through observation look for evidence that students are able to demonstrate correct intonation to express appropriate meaning.

- Look for evidence that students are able to
 - pronounce the letters of the alphabet correctly
 - use punctuation correctly

Planet@ 1

pp. 8–10

Colección tiempo: Para pronunciar



PRESCRIBED OUTCOMES	SUGGESTIONS FOR INSTRUCTION
<p>2.1 attend to form (continued)</p> <p>2.1.3 <i>Lexicon</i></p> <ul style="list-style-type: none">❖ use a repertoire of words and phrases in familiar contexts that meet the needs and interests of students, particularly within the following areas of experience:<ul style="list-style-type: none">— people around me<ul style="list-style-type: none">✓ greetings✓ personal information✓ family✓ people and their characteristics✓ the human body✓ clothing— activities<ul style="list-style-type: none">✓ daily✓ favourite✓ student✓ leisure— celebrations—<ul style="list-style-type: none">personal— school<ul style="list-style-type: none">✓ in the classroom✓ time and calendar✓ weather— introduction to the Spanish-speaking world (geography)	<ul style="list-style-type: none">➤ Have students work in groups of three or four. Provide each group with pictures of a variety of vocabulary words studied in class. Say a particular vocabulary word out loud and have students show the picture of the word to the class as soon as they find it. This activity could be done as a game, with a point given to the team who shows the picture first.➤ Have students play a variety of games in order to develop vocabulary. For example, use laminated games of “Snakes and Ladders,” dice, and markers. Include pictures of vocabulary studied in themes in certain boxes of the game. Player One rolls the dice and moves the marker the correct number of spaces from left to right. He/she must identify the word in Spanish the marker is covering. The next player then rolls the dice. Students move up the ladder or down the snake. The winner is the person who is able to complete the board and land on the last square first. The player must roll the exact number necessary to reach the last square (Manitoba Education and Training, <i>Grades 5 to 8 English Language Arts: A Foundation for Implementation, Strategies</i>–238).➤ Have students work in groups of three or four. Have groups play the game “<i>Veo, Veo</i>” (I Spy).<ul style="list-style-type: none">“<i>Veo, veo</i>”“<i>¿Qué ves?</i>”“<i>Una casa.</i>”“<i>¿De qué color?</i>”, etc.➤ <i>Checkers</i>: Prepare a checkers board with pictures of vocabulary studied in a theme. Player One covers the first row with white checkers and Player Two covers the first row on the opposite side with red checkers. Player One moves diagonally forward, identifying and spelling the Spanish word the checker was on. The game continues as in checkers (Manitoba Education and Training, <i>Grades 5 to 8 English Language Arts: A Foundation for Implementation, Strategies</i>–238).



SUGGESTIONS FOR ASSESSMENT

SUGGESTED LEARNING RESOURCES

- When students play games such as checkers or “Snakes and Ladders,” note the extent to which students are able to
 - identify game vocabulary in Spanish
 - engage themselves in the game
 - cooperate with group members
 - seek help for language clarification

*¡Viva el Español!: ¡Hola!
Resource and Activity Book
Vocabulary cards
Masters 34–96*

*¡Viva el Español!: ¡Hola!
Resource and Activity Book
Game/Activity Pages
Masters 136–154*

USO interactivo del vocabulario

Rosetta Stone I and II



PRESCRIBED OUTCOMES	SUGGESTIONS FOR INSTRUCTION
<p>2.1 attend to form (continued)</p> <p>2.1.4 <i>Grammatical Elements</i></p> <ul style="list-style-type: none">❖ use, in modelled situations, the following grammatical elements:<ul style="list-style-type: none">— <i>me/te/le gusta/n</i>— commonly used verbs: <i>ir, querer</i>— regular <i>ir</i> and <i>er</i> verbs in the present tense— <i>tener que</i> + infinitive— <i>ir + a</i> + infinitive— definite and indefinite articles: <i>el, la, lo, las, los, un, una, unas, unos</i>— possessive adjectives: <i>mi, tu, su, mis, tus, sus</i>— demonstrative adjectives and pronouns: <i>este/a, ese/a, aquel/la, estos/as, esos/as, aquellos/as</i>	<p>Modelled Situations: This term is used to describe learning situations where a model of specific grammatical elements is consistently provided and immediately available. Students in such situations will have an emerging awareness of the grammatical elements and be able to apply them in very limited situations. Limited fluency and confidence characterize student language.</p> <p>Example of a modelled situation:</p> <p>In preparation for a group project, students will keep a journal of their daily activities for a week. Students practise the structure "<i>tener que</i> + infinitive" using the sentence patterns provided. Each student asks five classmates, <i>¿Qué tienes que hacer después de clases hoy?</i> Students answer saying, <i>Tengo que . . .</i>, with an infinitive of their choice. Each person then summarizes the results of their mini survey, <i>Tres estudiantes tienen que estudiar</i>, and so on.</p>



SUGGESTIONS FOR ASSESSMENT

- Observe students as they do the exercise. Are they able to
 - ask the question following the model
 - respond to the question using “ *tengo que + infinitive* ”
 - summarize their results using third person singular and plural forms of the verb *tener* in a comprehensive manner

SUGGESTED LEARNING RESOURCES

¡En español! 1
 Actividad 17, p. 110

USO de la gramática española:
Junior elemental

Colección tiempo: Para conjugar

Rosetta Stone I and II



PRESCRIBED OUTCOMES	SUGGESTIONS FOR INSTRUCTION
<p>2.1 attend to form (continued)</p> <p>2.1.4 <i>Grammatical Elements</i></p> <ul style="list-style-type: none">❖ use, in structured situations, the following grammatical elements:<ul style="list-style-type: none">— subject pronouns: <i>yo, tú, él, ella, usted, nosotros/as, vosotros/as, ustedes</i>— affirmative/negative/interrogative sentences in the present tense— regular <i>-ar</i> verbs in the present tense— gender and number of nouns, adjectives— commonly used verbs: <i>ser, estar, tener</i>	<p>Structured Situations: This term is used to describe learning situations where a familiar context for the use of specific grammatical elements is provided and students are guided in their use. Students in such situations will have increased awareness and emerging control of the grammatical elements and be able to apply them in familiar contexts with teacher guidance. Student language is characterized by increasing fluency and confidence.</p> <p>Example of a structured situation:</p> <p>In preparation for a research project on typical activities of young people in selected Spanish-speaking countries, students listen to a rapid conversation where a Canadian student is talking to an exchange student from Mexico. The students check off, on a prepared answer sheet, what the exchange student does and does not do.</p>

N.B. Ensure students are aware that *usted* is used throughout Latin America but *vosotros/as* is used in Spain. However, for general classroom practice choose to use one or the other and do so consistently.



SUGGESTIONS FOR ASSESSMENT

- When correcting student answers, note if they are able to
 - distinguish affirmative from negative responses
 - match the infinitive form of the verb on the answer sheet with the conjugated form heard in the recorded conversation

SUGGESTED LEARNING RESOURCES

*USO de la gramática española:
Junior elemental*
Colección tiempo: Para conjugar
Rosetta Stone I and II



PRESCRIBED OUTCOMES	SUGGESTIONS FOR INSTRUCTION
<p>2.2 interpret and produce oral texts</p> <p>2.2.1 <i>Aural Interpretation</i></p> <ul style="list-style-type: none">❖ understand simple sentences in guided situations <p>2.2.2 <i>Oral Production</i></p> <ul style="list-style-type: none">❖ produce simple words and phrases in guided situations <p>2.2.3 <i>Interactive Fluency</i></p> <ul style="list-style-type: none">❖ engage in simple interactions, using short, isolated lexical phrases	<ul style="list-style-type: none">➤ Have students listen to a tape of an event or story. Then have students answer simple comprehension questions (oral or written).➤ Post several pictures of people in the classroom. Number each picture. Then give a description of each person, without indicating which person is being described. Students must guess which person corresponds to the description given.➤ Refer to the last example provided in Written Production, Year 1 – 40.➤ Suggest that students in groups organize small garage sales or an outdoor Mexican market, real or simulated. Have purchasers state what they are looking for and ask for information about the items. Ask vendors and purchasers to exchange greetings. Encourage students to discuss prices and bargain for items they want to purchase (<i>BC Resource Package, 44</i>).➤ Have students prepare a variety of guided role plays related to themes studied.



SUGGESTIONS FOR ASSESSMENT

SUGGESTED LEARNING RESOURCES

➤ When students respond to questions related to an event or story, look for evidence that they are able to

- respond with accurate information
- recount the event or events in the correct sequence, using simple sentences

¡Buen Viaje! 1A
Listening Tapes
Capítulo 1–4

¡Dime! Uno
Unidad 2, Lección 1

Planet@ 1
p. 98

¡En español! 1

¡Buen Viaje! 1A
Capítulo 3

¡En español! 1

➤ Discuss criteria with students before they role-play situations such as garage sales. The teacher may wish to develop a checklist students can use for self and peer assessment. Criteria might include the following:

- meaning is clear
- appropriate details are included in questions and answers
- gestures and body language support communication (language competence, visual representation)
- pronunciation and intonation are generally accurate (language competence, phonology)
- interaction has some sense of fluency and spontaneity

(See role-play assessment criteria in Classroom Assessment, p. 11.)

¡Viva el Español!: ¡Hola!
Resource and Activity Book
¡A conversar ya leer!
Masters 107–116



PRESCRIBED OUTCOMES	SUGGESTIONS FOR INSTRUCTION
<p>2.3 interpret and produce written texts</p> <p>2.3.1 <i>Written Interpretation</i></p> <ul style="list-style-type: none"> ❖ understand simple sentences in guided situations 	<ul style="list-style-type: none"> ➤ Provide students with a timetable belonging to a student from a Spanish-speaking country. Have students use the timetable to extract information, using teacher-generated questions (<i>BC Resource Package, 14</i>). ➤ Have students form groups of three or four. Provide students with a simple text that has been divided into three or four sections. (Each section may be only three or four sentences in length.) For the first part of the activity, give each group a section of the text. Each member of the group has the same part of the text. Students read their section of the text together and discuss. Students then regroup into new groups where each member of the group has a different part of the text (jigsaw). (See <i>Teaching and Learning, p. 77</i>.) Students read text together, put it into the correct order, and then present the main ideas of the text. They may either illustrate, present an oral summary, or prepare a written summary.
<p>2.3.2 <i>Written Production</i></p> <ul style="list-style-type: none"> ❖ produce simple words and phrases in guided situations 	<ul style="list-style-type: none"> ➤ After having extracted information from a Spanish student’s timetable, invite each student to prepare a timetable in Spanish, noting subjects and teachers. Ask students to display their timetables on a bulletin board. ➤ Provide students with a sample form letter or email. Have students develop their own letter or email and send them to a Spanish exchange class (<i>BC Resource Package, 36</i>). ➤ Post a variety of pictures related to themes studied— people, favourite activities, geography, etc. Have students prepare a written description of the pictures.



SUGGESTIONS FOR ASSESSMENT	SUGGESTED LEARNING RESOURCES
<ul style="list-style-type: none"> ➤ When students extract information from a student’s timetable, look for evidence that they are able to <ul style="list-style-type: none"> • find the appropriate information • use appropriate vocabulary (language competence, oral production) • answer questions in simple sentences as much as possible (language competence, oral production) ➤ When students participate in a jigsaw activity to understand a simple text, look for evidence that they are able to summarize the main ideas of the text in an organized sequence (language competence, production—written or oral). 	<p><i>Chicos Chicas, Nivel 1</i> Unidad 3, Lección 6 p. 42, #2 and #3</p> <p><i>Chicos Chicas, Nivel 1</i> Unidad 3, Lección 6, p. 42, #2 and #3</p> <p><i>Chicos Chicas, Nivel 1</i> Unidad 1, p. 24 Unidad 4, p. 60 Unidad 6, p. 84</p>
<ul style="list-style-type: none"> ➤ Work with students to develop a simple checklist they can use for self and peer assessment of their letters or emails. The checklist might include items such as the following: <ul style="list-style-type: none"> • sentence frames are written correctly and completed appropriately • meaning is clear • greeting and closing are appropriate (language competence, discourse) • punctuation is appropriate (language competence, orthography) • spelling, including accents, is correct (language competence, orthography) 	<p><i>¡Viva el Español!: ¡Hola!</i> <i>Resource and Activity Book</i> Masters 1–154</p>



PRESCRIBED OUTCOMES	SUGGESTIONS FOR INSTRUCTION
<p>2.3 interpret and produce written texts (continued)</p> <p>2.3.2 <i>Written Production (continued)</i></p> <ul style="list-style-type: none">❖ produce simple words and phrases in guided situations	<p>➤ Aural, written, visual, interactive, and oral—Have students work in pairs. One student receives a picture of “an extra-terrestrial being” (“<i>un ser extraterrestre o un alienígena</i>”). This student describes his creature to his/her partner without showing the picture. The partner must draw the extra-terrestrial being, based on the description given by his/her partner and by asking questions to clarify the description.</p> <p>Students then prepare, in collage form, their own extra-terrestrial being. They then prepare a written paragraph which describes their creation. Students present both the written paragraph and the collage to the class.</p>



SUGGESTIONS FOR ASSESSMENT

- When students work in pairs to draw extra-terrestrials based on descriptions given, look for evidence that
 - the drawings of the partners are similar
 - students have attempted to use simple sentences in their descriptions
 - students are able to react to and clarify the description

Discuss criteria for the collage, written description, and oral presentation of an extra-terrestrial of the student's own creation.

Criteria for the collage might include the following:

- a variety of body parts are represented
- collage is well organized

Criteria for the written description might include the following:

- the written description corresponds accurately to the collage
- number and type of body parts are described accurately
- simple verbs such as *ser* and *tener* are used correctly (language competence, attend to form)
- adjectives are used correctly (language competence, attend to form)

Criteria for the oral presentation might include the following:

- student speaks clearly and with appropriate pronunciation (language competence, phonology)
- student uses the collage effectively as a visual aid to support the presentation

SUGGESTED LEARNING RESOURCES

Chicos Chicas, Nivel 1
Unidad 5, pp. 56–57



PRESCRIBED OUTCOMES	SUGGESTIONS FOR INSTRUCTION
<p>2.3 interpret and produce written texts (continued)</p> <p>2.3.2 <i>Written Production (continued)</i></p> <ul style="list-style-type: none">❖ produce simple words and phrases in guided situations	<p>➤ Written, Oral, Visual</p> <p>Lead a discussion with students on the topic of “What Makes a Good School?” (“¿Qué es lo que hace que una escuela sea buena?”) Use a graphic organizer to record students’ responses.</p> <p>Working in pairs or small groups, students design an ideal school of the future. Encourage them to think creatively and imaginatively. Remind them that certain elements must be present in the design: a floor plan with all areas labeled in the target language and a student handbook with such information as the school philosophy, number of students, curricular offerings, schedules, school rules (regarding dress, discipline, etc.), a school calendar, school colours, mottos, a song and a mascot, food services, activities and athletics, innovative programs, and a media centre.</p> <p>Students work together to create as many visual/aural representations of each aspect of the school of the future as possible.</p> <p>In pairs or groups, students present their projects to the class. The media specialist or a student videotapes the presentations.</p> <p>Create a roundtable discussion in which students further express their views about the ideal school. Arrange for these discussions to be videotaped. The videotape can be shown at a parents’ night or a curriculum fair.</p> <p>Display student projects in the school’s main lobby with a short introductory written description.</p>



SUGGESTIONS FOR ASSESSMENT

➤ Discuss criteria for the written description, and the visual and oral presentations of the ideal school. Criteria for the visual representation might include the following:

- all necessary elements are present in the design
- visual presentation is well organized

Criteria for the written description might include the following:

- the written description corresponds accurately to the visual presentation
- school elements are described accurately
- simple verbs such as *ser* and *tener* are used correctly (language competence, attend to form)

Criteria for the oral presentation might include the following:

- student speaks clearly and with appropriate pronunciation (language competence, phonology)
- student uses the visual presentation effectively to support the oral presentation

(See criteria for written and oral presentations in Classroom Assessment, pp. 11–15.)

SUGGESTED LEARNING RESOURCES

--



PRESCRIBED OUTCOMES	SUGGESTIONS FOR INSTRUCTION
<p>2.3 interpret and produce written texts (continued)</p> <p>2.3.3 <i>Visual Interpretation</i></p> <ul style="list-style-type: none">❖ derive meaning from visuals and other forms of non-verbal communication in guided situations <p>2.3.4 <i>Representing</i></p> <ul style="list-style-type: none">❖ use visuals and other forms of non-verbal communication to express meaning in guided situations	<ul style="list-style-type: none">➤ Provide students with a variety of clothing advertisements from Spanish catalogues or magazines. Have students consider in which situations the clothing would be worn.➤ Have students play pictictionary or charades with vocabulary related to themes studied.
<p>2.4 apply knowledge of the sociocultural context</p> <p>2.4.1 <i>Register</i></p> <ul style="list-style-type: none">❖ distinguish between formal and informal situations❖ respond to tone of voice	<ul style="list-style-type: none">➤ Have students view a simple video and have them note when characters use <i>tú</i> and when they use <i>usted</i>.➤ In order to help students distinguish between the use of <i>tú</i> and <i>usted</i>, provide students with pictures of different people in conversation (e.g., two young people, a child and an older person, etc.). Then have students draw in cartoon bubbles above the pictures and complete with simple dialogue using either <i>tú</i> or <i>usted</i>.



SUGGESTIONS FOR ASSESSMENT

SUGGESTED LEARNING RESOURCES

- When students play games such as pictionary or charades, look for evidence that they
 - draw or dramatize the vocabulary accurately
 - participate actively in the game

- When students view a video with situations where characters use *tú* or *usted*, look for evidence that students are able to
 - identify the types of situations in which *tú* and *usted* are used
 - explain why the formal or informal register is used

- When students prepare simple dialogue to correspond with pictures of a variety of people in conversation, look for evidence that students are able to use *tú* and *usted* in the appropriate situations.

¡Viva el Español!: ¿Qué tal?
Resource and Activity Book
 Blackline Masters
 Vocabulary

¡Viva el Español!: ¡Hola!
Resource and Activity Book
 Blackline Masters
 Vocabulary

¡Viva el Español!: ¡Adelante!
Resource and Activity Book
 Blackline Masters
 Vocabulary

¡En español! 1
 Unidad 1, Etapa 1
 Actividad 6
 Video : En vivo

Chicos Chicas, Nivel 1
 Unidad 1, p. 15, #3–5



PRESCRIBED OUTCOMES	SUGGESTIONS FOR INSTRUCTION
<p data-bbox="103 281 500 384">2.4 apply knowledge of the sociocultural context (continued)</p> <p data-bbox="103 407 440 441">2.4.2 <i>Idiomatic Expressions</i></p> <ul data-bbox="175 464 532 531" style="list-style-type: none">❖ imitate age-appropriate idiomatic expressions <p data-bbox="103 1102 461 1136">2.4.3 <i>Variations in Language</i></p> <ul data-bbox="175 1159 537 1402" style="list-style-type: none">❖ identify variations in language (regional, age-related)❖ experience a variety of voices <p data-bbox="103 1591 407 1625">2.4.4 <i>Social Conventions</i></p> <ul data-bbox="175 1648 505 1787" style="list-style-type: none">❖ use basic forms of politeness and social conventions (e.g., <i>por favor, gracias</i>)	<p data-bbox="605 464 1349 531">➤ Idiomatic expressions, social conventions, non-verbal communication:</p> <p data-bbox="654 548 1404 615">Provide students with some simple idiomatic expressions and social conventions.</p> <p data-bbox="654 636 1365 804">Students work in groups and choose one to two expressions. They then prepare a skit that incorporates these idiomatic expressions as well as basic social conventions commonly used in Spanish-speaking countries.</p> <p data-bbox="605 1159 1382 1297">➤ Have students listen to a video or audiotape that demonstrates a variety of speakers of different ages and regions of the Spanish-speaking world. Have students focus on voices and individual differences in speech.</p> <p data-bbox="605 1339 1390 1514">➤ Present students with clothing vocabulary used in different Spanish-speaking countries. Have students choose the clothing from one country and create a comic strip of people meeting in a department store (e.g., Mexican boy meets Argentinian girl).</p> <p data-bbox="605 1648 1386 1885">➤ Distribute pictures or show an extract of a video that depicts people greeting each other in different ways. Discuss students' interpretation of what is happening in the pictures or video. Discuss cultural differences in greetings. Have students prepare a simple role play that depicts two people from different cultures greeting each other.</p>



SUGGESTIONS FOR ASSESSMENT

SUGGESTED LEARNING RESOURCES

- Discuss criteria with students before they role-play situations in which idiomatic expressions, social conventions, and non-verbal communication are to be used. The teacher may wish to develop a checklist students can use for self and peer assessment. Criteria might include the following:
 - meaning is clear
 - at least one idiomatic expression is used
 - appropriate social conventions have been included
 - appropriate non-verbal communication (gestures) have been included to support communication
 - pronunciation and intonation are generally accurate (language competence, phonology)
 - interaction has some sense of fluency and spontaneity (language competence, interactive fluency)

(See role-play criteria in Classroom Assessment, p. 11.)

- When students listen to a video or audiotape, look for evidence that students are able to identify variations in language, voices, and speech.

- When students create their own Spanish-language cartoons using greetings from different Spanish-speaking countries, look for evidence that the vocabulary is appropriate for the country or countries chosen.

- As students view and role-play various greetings, look for evidence that they are able to
 - imitate simple routine social interactions
 - use basic social expressions
 - use basic politeness conventions

¡Dime! Uno
 Unidad 1, Lección 1

¡Buen Viaje! 1
 Capítulo 1, Preliminar
 Capítulo 3, p. 83



PRESCRIBED OUTCOMES	SUGGESTIONS FOR INSTRUCTION
<p>2.4 apply knowledge of the sociocultural context (continued)</p> <p>2.4.5 <i>Non-Verbal Communication</i></p> <ul style="list-style-type: none">❖ understand the meaning of and imitate some common non-verbal behaviours used in Spanish-speaking cultures (e.g., shrugging shoulders)	<p>➤ Refer to previous example.</p>
<p>2.5 apply knowledge of how text is organized, structured, and sequenced</p> <p>2.5.1 <i>Cohesion/Coherence</i></p> <ul style="list-style-type: none">❖ follow and imitate speech that uses simple link words (e.g., <i>pero, porque</i>)	<p>➤ Provide students with three or four pictures of activities. Students must then organize the pictures in the most logical sequence, using <i>primero, después, luego, al final</i>.</p>
<p>2.5.2 <i>Text Forms</i></p> <ul style="list-style-type: none">❖ recognize a variety of oral and written text forms (e.g., recipes, invitations, messages)❖ use some simple text forms in their own productions (e.g., maps, questionnaires)	<p>➤ Have students prepare lists:</p> <ul style="list-style-type: none">• clothing for different seasons• favourite activities in winter and summer <p>Using a simple form letter, have students write a letter to someone from a Spanish-speaking country who is coming to visit. In the letter, students indicate what clothing is needed in Canada and which activities are possible.</p> <p>➤ Have students work in pairs in order to email each other a simple message in Spanish.</p>



SUGGESTIONS FOR ASSESSMENT

SUGGESTED LEARNING RESOURCES

- Prepare a checklist for assessment of students' organization of pictures in a logical sequence. Criteria might include the following:
 - four linear connectors are used
 - pictures are in a logical sequence (applications, extend their knowledge of the world)
 - appropriate simple descriptions are given for each picture (language competence, oral/written production)

- Work with students to develop a simple checklist they can use for self and peer assessment of their letters or email. The checklist might include items such as the following:
 - details of appropriate clothing and activities for the seasons are given
 - sentence frames are written correctly and completed appropriately
 - meaning is clear (applications)
 - greeting and closing are appropriate
 - punctuation is appropriate (language competence, orthography)
 - spelling, including accents, is correct (language competence, orthography)

(See examples of checklist criteria in Classroom Assessment, p. 12.)

Dos Mundos
Student Edition

¡En español! 1
Mas comunicación
Actividad 4

¡Dime! Uno
Unidad 5, Lección 2

¡Buen Viaje! 1A
Capítulo 3



PRESCRIBED OUTCOMES	SUGGESTIONS FOR INSTRUCTION
<p data-bbox="102 279 563 384">2.5 apply knowledge of how text is organized, structured, and sequenced (continued)</p> <p data-bbox="102 405 526 436"><i>2.5.3 Patterns of Social Interaction</i></p> <ul data-bbox="175 464 542 667" style="list-style-type: none">❖ respond using very simple social interaction patterns (e.g., question-answer, greeting-response, invitation-accept/decline)	<p data-bbox="605 533 1416 604">➤ At the beginning and at the end of the class, invite each student to use a different salutation or farewell expression.</p> <p data-bbox="654 625 1416 697">Outside the class, greet students in Spanish using different salutations or farewell expressions.</p>



SUGGESTIONS FOR ASSESSMENT

- As students use a variety of salutations and farewell expressions, look for evidence that they are able to
 - respond orally as they enter and exit the classroom
 - use a variety of expressions

SUGGESTED LEARNING RESOURCES

¡Buen Viaje! 1A



Notes

*GLOBAL
CITIZENSHIP
YEAR 1*



Global Citizenship



study historical and contemporary elements of Spanish-speaking cultures

affirm diversity

Students will acquire the knowledge, skills, and attitudes to be effective global citizens, through the exploration of the cultures of the Spanish-speaking world.

explore personal and career opportunities



GLOBAL CITIZENSHIP

General Outcome 3: Students will acquire the knowledge, skills, and attitudes to be effective global citizens, through the exploration of the cultures of the Spanish-speaking world.

The outcomes for Global Citizenship deal with a broad range of knowledge, skills, and attitudes needed to be effective global citizens—in other words, with the development of intercultural competence. The concept of global citizenship encompasses citizenship at all levels, from the local school and community to Canada and the world.

The various components of global citizenship are grouped under three cluster headings—see the illustration on the preceding page. Under each of these headings there are several strands. Each strand deals with a single aspect of intercultural competence. For example, under the cluster heading **study historical and contemporary elements of Spanish-speaking cultures**, there are strands for the processes and methods of acquiring knowledge about Spanish-speaking cultures, the cultural knowledge thus acquired, applications of that knowledge to aid comprehension and to communicate in appropriate ways, positive attitudes toward Spanish-speaking cultures, as well as knowledge of the diversity within those cultures.

Developing cultural knowledge and skills is a lifelong process. Knowledge of one's own culture is acquired over a lifetime. Cultures change over time. Within any national group, there may be a dominant culture or cultures and a number of minority cultures. Rather than try to develop an extensive bank of knowledge about the Spanish-speaking cultures, it is more important for students to learn the processes and methods of accessing and analyzing cultural practices. Students will gain cultural knowledge in the process of developing these skills. In this way, if they encounter elements of the Spanish-speaking cultures they have not learned about in class, they will have the skills and abilities to deal with them effectively and appropriately.

The **affirm diversity** heading covers knowledge, skills, and attitudes that are developed as a result of bringing other languages and cultures into relationship with one's own. There is a natural tendency, when learning a new language and culture, to compare it with what is familiar. Many students leave a second language learning experience with a heightened awareness and knowledge of their own language and culture. They will also be able to make some generalizations about languages and cultures based on their experiences and those of their classmates who may have a variety of cultural backgrounds. This will provide students with an understanding of diversity within both a global and a Canadian context.



PRESCRIBED OUTCOMES	SUGGESTIONS FOR INSTRUCTION
<p>General Outcome 3: Global Citizenship</p> <p>Students will acquire the knowledge, skills, and attitudes to be effective global citizens through the exploration of the cultures of the Spanish-speaking world.</p> <p>3.1 study historical and contemporary elements of Spanish-speaking cultures</p> <p>3.1.1 <i>Access/Analyze Cultural Knowledge</i></p> <ul style="list-style-type: none">❖ ask questions, using their first language, about elements of Spanish-speaking cultures experienced in class <p>3.1.2 <i>Knowledge of Spanish-Speaking Cultures</i></p> <ul style="list-style-type: none">❖ participate in activities and experiences that reflect elements of Spanish-speaking cultures	<p>➤ As a class, choose one Spanish-speaking country to research. Divide the class into groups and have each group research one aspect of the country (one celebration, family life, clothing, food, pastimes, etc.). Have students prepare a written and an oral presentation of the information found. Have students also prepare an activity, related to their topic, in which the class could participate (e.g., making a type of food, playing a game, etc.).</p> <p>➤ Have students make up their own nametags using a traditional format from the Spanish-speaking world (e.g., first and second names followed by father’s surname and mother’s maiden name).</p> <p>As an extension activity, give pairs of students imaginary family trees listing the names of grandparents, parents, and other relatives, and have them fill in the names of the children, beginning with the oldest child (<i>BC Resource Package, 26</i>).</p>



PRESCRIBED OUTCOMES	SUGGESTIONS FOR INSTRUCTION
<p>3.1 study historical and contemporary elements of Spanish-speaking cultures (continued)</p> <p>3.1.3 <i>Apply Cultural Knowledge</i></p> <ul style="list-style-type: none">❖ recognize elements of Spanish-speaking cultures in the local community <p>3.1.4 <i>Diversity of Spanish-Speaking Cultures</i></p> <ul style="list-style-type: none">❖ experience diverse elements of Spanish-speaking cultures <p>3.1.5 <i>Value Spanish-Speaking Cultures</i></p> <ul style="list-style-type: none">❖ participate in cultural activities and experiences	<ul style="list-style-type: none">➤ Have students watch a video of a birthday party in a Spanish-speaking country and note similarities and differences to their own celebrations. On the students' birthdays, sing "<i>Cumpleaños Feliz</i>" or another Spanish birthday song.➤ Invite guests from different Spanish-speaking cultures in the local community to the class. Have students prepare questions for the guests and then discuss the new information gathered about Spanish-speaking cultures in the community.➤ Give students the opportunity for guided correspondence with a pen pal in a Spanish-speaking country.



SUGGESTIONS FOR ASSESSMENT

SUGGESTED LEARNING RESOURCES

- When invited guests speak to the class, observe to what extent students
 - ask relevant questions
 - listen attentively to the guest
 - demonstrate an effort to speak Spanish
 - identify specific elements of Spanish-speaking cultures in the community, with the help of guest’s information

(See guest observation checklist in Planning, p. 73.)

¡Dime! Uno
Unidad 1



PRESCRIBED OUTCOMES	SUGGESTIONS FOR INSTRUCTION
<p>3.2 affirm diversity</p> <p>3.2.1 <i>Awareness of First Language</i></p> <ul style="list-style-type: none">❖ identify similarities between their first language and Spanish (e.g., basic word order) <p>3.2.2 <i>General Language Knowledge</i></p> <ul style="list-style-type: none">❖ identify differences and similarities among writing systems from different languages within their personal experience❖ describe ways languages can be taught and learned	<p>➤ Present students with vocabulary in Spanish that is similar to English/French (e.g., <i>participación, interesante</i>, etc.).</p> <p>Have students explain the similarities and differences between the English/French and Spanish words.</p> <p>➤ Present important grammatical differences in word order (e.g., a smart man, <i>un hombre inteligente</i>).</p> <p>➤ Point out the origins of the Spanish language and the English language.</p> <p>➤ Provide students with a list of words in Spanish, English, French, German, Italian, and Portuguese. Have students work in groups to categorize the words according to commonalities. Have students draw conclusions about families of languages (e.g., French—<i>la main</i>; Spanish—<i>la mano</i>; Portuguese—<i>a mão</i>; Italian—<i>la mano</i>; German—<i>die Hand</i>).</p> <p><i>Extension:</i> Invite students who speak other languages to contribute to the lists.</p>



SUGGESTIONS FOR ASSESSMENT

- As students describe family celebrations and events, they can show their awareness of similarities across cultures through representations such as the following:
 - Venn diagrams showing common and unique features
 - picture charts comparing features of activities in Spanish-speaking cultures with related activities in other cultures
 - collages of pictures, symbols, and words from a variety of cultures, based on a common theme (e.g., greeting words, festive occasions, family celebrations such as birthdays and weddings, names)

- Before students begin, discuss criteria such as the following:
 - number of features
 - logic of associations
 - accuracy of their portrayals of cultural aspects

- Note students' participation in and response to creative works. Students may show their interest by
 - being attentive when a new activity is introduced
 - taking risks to take part in creative activities
 - suggesting that the class repeat or extend creative activities they have enjoyed (BC *Resource Package*, 25)

SUGGESTED LEARNING RESOURCES

- ¡Dime! Uno*
Unidad 4, Lección 1, 2
- Destinos: An Introduction to Spanish*
Video Series
Episodio 3
La Semana Santa
- Das Mundos*
Student Edition
-
- ¡Buen Viaje! 1*
Teacher's Edition
Capítulo 4
Actividades comunicativas 3
- Abrir Paso Libro 1*
-
- ¡Dime! Uno*
Unidad 4, Lección 1



PRESCRIBED OUTCOMES	SUGGESTIONS FOR INSTRUCTION
<p>3.2 affirm diversity (continued)</p> <p>3.2.5 <i>Value Diversity</i></p> <ul style="list-style-type: none">❖ interact with others who are different <p>3.2.6 <i>Intercultural Skills</i></p> <ul style="list-style-type: none">❖ adapt to new situations	<ul style="list-style-type: none">➤ Have students change partners regularly for new activities. <ul style="list-style-type: none">➤ Discuss stereotypes and how they can limit people. Provide students with pictures that show stereotypes of Canada (e.g., RCMP in red uniforms, Aboriginals in wilderness settings, etc.). Ask students how representative these pictures are of Canadian culture. Then provide students with stereotypical pictures of Spanish culture (e.g., Mexican men in sombreros sleeping, etc.). Discuss with students how accurate these images might be.
<p>3.3 personal and career opportunities</p> <p>3.3.1 <i>Spanish Language and Spanish-Speaking Cultures</i></p> <ul style="list-style-type: none">❖ suggest some reasons for learning Spanish	<ul style="list-style-type: none">➤ At the beginning of the course, have students respond to the question: Why study Spanish? This can be done as a brainstorming activity. Display a poster in the classroom with the responses given by the students.



SUGGESTIONS FOR ASSESSMENT

- As students work with a variety of students in the class, observe the extent to which they are
 - willing and open to work with different classmates
 - willing to cooperate in order to carry out tasks in pairs

- Observe the extent to which students
 - show sensitivity towards classmates, the community, and current events
 - listen attentively to and acknowledge opinions that are different from their own

- Have students respond in a learning log to the following questions:
 - What are the most important reasons for learning Spanish, for you personally?
 - Did you see new/different reasons for learning Spanish, based on the class discussion? If so, which of these would you now consider as personally important?
 - What advantages are there to learning world languages? How might this benefit you in the future?

SUGGESTED LEARNING RESOURCES

Chicos Chicas, Nivel 1
 Al final de cada unidad
 Sección: El conocimiento del Mundo hispano

Planet@ 1
 Sección: 350 millones



PRESCRIBED OUTCOMES	SUGGESTIONS FOR INSTRUCTION
<p>3.3 personal and career opportunities (continued)</p> <p>3.3.2 <i>Cultural and Linguistic Diversity</i></p> <ul style="list-style-type: none">❖ suggest some reasons for learning an additional language❖ suggest some reasons for participating in activities and experiences that reflect elements of different cultures	<p>➤ Provide students with maps and atlases. In groups, have students make a list of the countries or label maps where Spanish is spoken and where languages other than English are spoken.</p> <p>In their groups, have students discuss the following question: What are the purposes of learning world languages?</p>



SUGGESTIONS FOR ASSESSMENT

**SUGGESTED LEARNING
RESOURCES**

Chicos Chicas, Nivel 1
Unidad 0, pp. 6–9

¡Viva el Español!: ¡Hola!
Resource and Activity Book
Maps: Masters 131–135



Notes

STRATEGIES
YEAR 1





Strategies

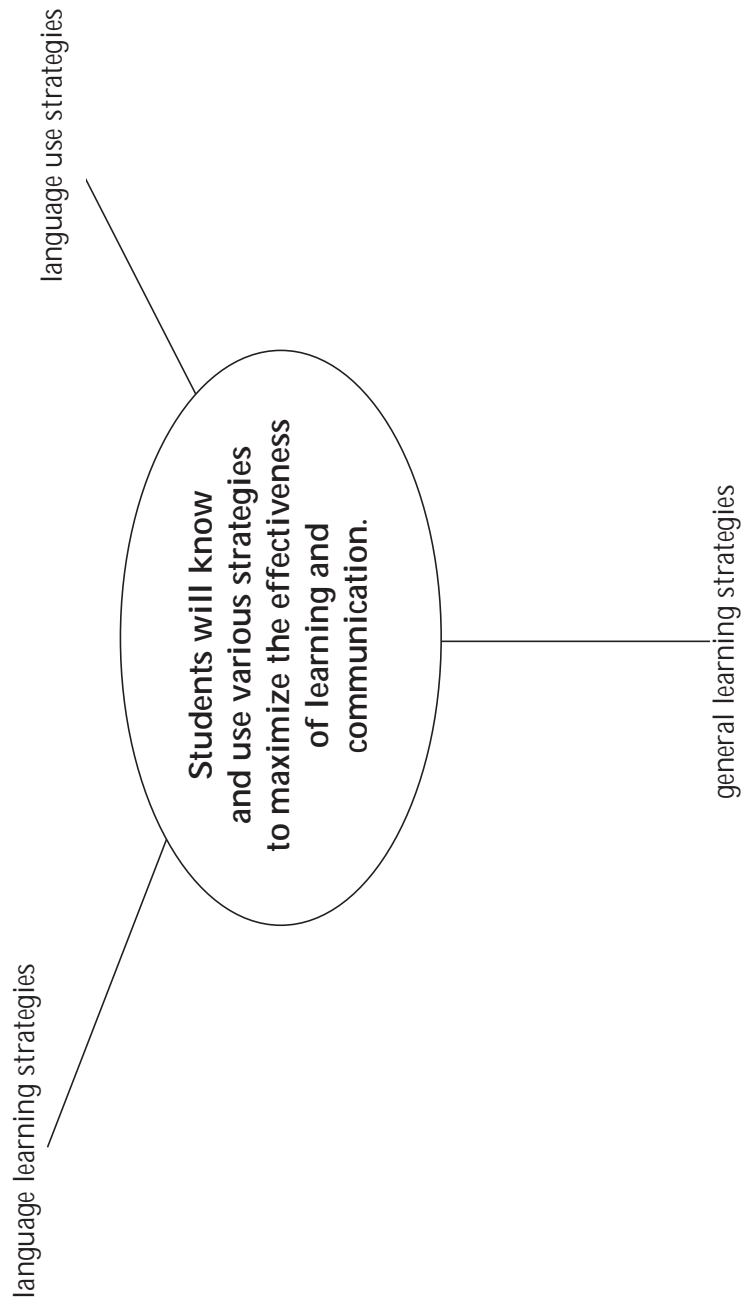



STRATEGIES

General Outcome 4: Students will know and use various strategies to maximize the effectiveness of learning and communication.

Under the Strategies heading are specific outcomes that will help students learn and communicate more effectively. Strategic competence has long been recognized as an important component of communicative competence. The outcomes that follow deal not only with compensation and repair strategies, important in the early stages of language learning when proficiency is low, but also with strategies for language learning, language use in a broad sense, as well as general learning strategies that help students acquire content. Although people may use strategies unconsciously, the outcomes deal only with the conscious use of strategies.

The strategies are grouped under three cluster headings—see the illustration on the preceding page. Under each of these headings there are several strands. Each strand deals with a specific category of strategy. Language learning and general learning strategies are categorized as cognitive, metacognitive, and social/affective. The language use strategies are organized by communicative mode: interactive, interpretive, and productive.

The strategies that students choose depend on the task they are engaged in as well as on other factors, such as their preferred learning style, personality, age, attitude, and cultural background. Strategies that work well for one person may not be effective for another person or may not be suitable in a different situation. For this reason it is not particularly useful to say that students should be aware of, or able to use, a specific strategy in a particular course. Consequently, the specific outcomes describe the students' knowledge of and ability to use general types of strategies. More specific strategies for each general category or type are included in the comprehensive list of strategies in Appendix E. The specific strategies provided in the comprehensive list are not prescriptive but are provided as an illustration of how the general strategies in the specific outcomes might be developed.

Teachers need to know and be able to demonstrate a broad range of strategies from which students are then able to choose in order to communicate effectively. Strategies of all kinds are best taught in the context of learning activities where students can apply them immediately and then reflect on their use.



PRESCRIBED OUTCOMES	SUGGESTIONS FOR INSTRUCTION
<p>General Outcome 4: Strategies Students will know and use various strategies to maximize the effectiveness of learning and communication.</p> <p>4.1 language learning strategies</p> <p>4.1.1 <i>Cognitive</i></p> <ul style="list-style-type: none">❖ use simple cognitive strategies, with guidance, to enhance language learning (e.g., learn short rhymes or songs incorporating new vocabulary or sentence patterns, imitate sounds and intonation patterns) <p>4.1.2 <i>Metacognitive</i></p> <ul style="list-style-type: none">❖ use simple metacognitive strategies, with guidance, to enhance language learning (e.g., make choices about how they learn) <p>4.1.3 <i>Social/Affective</i></p> <ul style="list-style-type: none">❖ use simple social and affective strategies, with guidance, to enhance language learning (e.g., participate in shared reading experiences)	<p>➤ Ask each student to create and maintain a personal dictionary. As new Spanish words are learned, encourage students to illustrate them in their dictionaries with drawings or magazine clippings (BC <i>Resource Package</i>, 12).</p> <p>➤ Have students role-play children’s stories (i.e., <i>Los Tres Cerditos</i>) using children’s Spanish books and short phrases for dialogue.</p> <p>➤ Have students discover how their own effort to participate daily in class will enhance their learning. At the end of the class, have students rate their performance on aspects of their daily communication.</p> <p>➤ Have students work in pairs in order to read and understand a simple story in Spanish. Have students then share reading comprehension strategies and write down the new strategy that they learned.</p>



SUGGESTIONS FOR ASSESSMENT

SUGGESTED LEARNING RESOURCES

- Check students' personal dictionaries for evidence that they are
 - adding an increasing variety of words
 - correctly matching pictures and labels
 - organizing words and phrases in logical ways
 - focusing on words that are useful or interesting to them

- At the end of class, have students use checklists to rate their performance on aspects of their daily oral communication. Items might include the following:
 - I volunteered questions and information.
 - I practised new vocabulary and patterns.
 - I talked only in Spanish.
 - I tried to correct my mistakes.
 - I supported and encouraged others.

- Provide frequent opportunities for students to reflect on what they have learned and set personal goals related to language skills. For example, at the beginning of a week or class, students might each record two goals or intentions such as
 - number of times they will speak Spanish
 - new vocabulary or structures they want to learn

- Check that students are aware of how working in pairs benefits their abilities to understand and to complete tasks.

¡En español! 1

Más comunicación

Gap activities

Actividad 5, 6, 7

Chicos Chicas, Nivel 1

(CD/cassette)

Unidad 7, Lección 13

p. 86, #1

¡Dime! Uno

Communicative Pair

Activities, Unidad 1, 2, 3, 4

Lección preliminar



PRESCRIBED OUTCOMES	SUGGESTIONS FOR INSTRUCTION
<p>4.2 language use strategies</p> <p>4.2.1 <i>Interactive</i></p> <ul style="list-style-type: none">❖ use simple interactive strategies, with guidance (e.g., interpret and use a variety of non-verbal clues to communicate) <p>4.2.2 <i>Interpretive</i></p> <ul style="list-style-type: none">❖ use simple interpretive strategies, with guidance (e.g., make connections between texts on the one hand, and prior knowledge and personal experience on the other) <p>4.2.3 <i>Productive</i></p> <ul style="list-style-type: none">❖ use simple productive strategies, with guidance (e.g., copy what others say or write, use words that are visible in the immediate environment)	<ul style="list-style-type: none">➤ As a class, have students listen to and sing simple Spanish songs (e.g., <i>Cielito Lindo</i>, <i>La Cucaracha</i>, <i>Burrito como tú</i>, <i>María Isabel</i>). As they sing along with the recording, ask them to mime and use gestures to represent and interpret the lyrics (BC <i>Resource Package</i>, 16).➤ Involve students in TPR (Total Physical Response) activities (see <i>Teaching and Learning</i>, p. 98).➤ Invite students to participate in the game “<i>Simón dice</i>” (“Simon says . . .”)➤ Prepare a story where pictures are used rather than certain words. Have students complete the story by interpreting the pictures and finding the Spanish equivalents.➤ Before reading an illustrated text, have students examine the pictures and guess what the text might be about. Have students confirm or refute their guesses as they read the text.➤ Provide opportunities for students to make reference to bilingual dictionaries to complete a variety of tasks. Teach students effective uses of bilingual dictionaries (e.g., abbreviations for masculine and feminine, where to find verb conjugations, how to choose from several words given as a translation, etc.).



SUGGESTIONS FOR ASSESSMENT	SUGGESTED LEARNING RESOURCES
<p>➤ While students are learning Spanish songs, look for evidence that students are</p> <ul style="list-style-type: none"> • curious about the meanings of songs • trying to match their interpretations (gestures and expressions) to the meanings or moods <p>➤ As students participate in TPR activities, look for evidence that they are able to</p> <ul style="list-style-type: none"> • listen actively to follow instructions • follow the leader’s instructions with correct movements <p>➤ As students complete a Spanish story by finding Spanish equivalents for pictures, look for evidence that</p> <ul style="list-style-type: none"> • words that are chosen to represent the pictures are logical • students are able to retell the story using the words they have chosen <p>(See story assessment criteria in Classroom Assessment, p. 16.)</p> <p>➤ As students use illustrations to predict meaning, look for evidence that they are able to</p> <ul style="list-style-type: none"> • use clues in illustrations to make predictions • confirm or refute predictions based on reading <p>➤ Look for evidence that students are using resources</p> <ul style="list-style-type: none"> • with more frequency • with greater independence • more effectively 	<p><i>¡Viva el Español!: ¡Hola!</i> Resource and Activity Book Song cassette (music and lyrics), pp. 48–59</p> <p><i>¡Buen Viaje! 1</i> CD 1</p> <p><i>¡Buen Viaje! 1</i> Expansion activities with TPR storytelling</p> <p><i>Chicos Chicas, Nivel 1</i></p> <p><i>Planet@ 1</i> Glosario</p> <p><i>Chicos Chicas, Nivel 1</i> Glosario, pp. 122–128 Conjugación, pp. 114–121</p>



PRESCRIBED OUTCOMES	SUGGESTIONS FOR INSTRUCTION
<p>4.3 general learning strategies</p> <p>4.3.1 <i>Cognitive</i></p> <ul style="list-style-type: none">❖ use simple cognitive strategies to enhance general learning (e.g., use models, classify objects) <p>4.3.2 <i>Metacognitive</i></p> <ul style="list-style-type: none">❖ use simple metacognitive strategies to enhance general learning (e.g., choose from among learning options) <p>4.3.3 <i>Social/Affective</i></p> <ul style="list-style-type: none">❖ use simple social and affective strategies to enhance general learning (e.g., seek help from others)	<p>➤ Provide students with 15–20 words on a theme to be studied (Word Splash). Have students identify words whose meanings they think they understand and those they do not understand. Students then work in pairs sharing definitions and searching for information on words they do not understand (Manitoba Education and Training, <i>Grades 5 to 8 English Language Arts: A Foundation for Implementation, Strategies–40</i>). Have students use five words in simple sentences.</p> <p>➤ Invite students to maintain a learning log. Students respond to questions such as: “How do you learn best (e.g., visually, orally, listening, speaking, etc.)?” / “¿Cómo aprendes mejor (<i>visualmente, oralmente, escuchando, hablando, etc.</i>)?”</p> <p>➤ Before students begin work in cooperative groups, work with students on specific cooperative skills. Provide students with examples of phrases or expressions in Spanish that would be appropriate for specific skills (e.g., encouraging each other, taking turns, etc.).</p> <p>Teach students Spanish words of encouragement (e.g., <i>Bueno, Bien hecho, Fantástico</i>).</p>



SUGGESTIONS FOR ASSESSMENT

- Have students use their learning logs to examine
 - words they already understood
 - how closely they were able to guess the meanings of words
 - how the new words relate to themes studied

- Take in students' learning logs from time to time. Students' logs could include the following:
 - observations and reflections about their learning
 - personal language goals
 - strategies that work well for them

Assessment criteria for the learning log could include the following:

 - Does the student use the log regularly?
 - Does the student show signs of understanding his/her personal learning style?

- Provide students with self and peer assessment forms for the cooperative group work that takes place in Appendices C, D, and E of this section.

SUGGESTED LEARNING RESOURCES

¡Dime! Uno
 Preliminar
 Unidad 1-4

¡Buen Viaje! 1
 Capítulo 1-4



Notes

APPENDICES
YEAR 1

Appendix A

My Presentation of Narrative Text / <i>Mi presentación de un relato</i>		
Name/ <i>Nombre</i> _____	Date/ <i>Fecha</i> _____	
	Yes / <i>Sí</i>	No / <i>No</i>
• Did I have a clear beginning?/ <i>¿Tuve un comienzo claro?</i>	<input type="checkbox"/>	<input type="checkbox"/>
• Did I include details in order for the middle?/ <i>¿Incluí detalles para los acontecimientos en orden lógico?</i>	<input type="checkbox"/>	<input type="checkbox"/>
• Did I have a strong ending?/ <i>¿Tuve un final eficaz?</i>	<input type="checkbox"/>	<input type="checkbox"/>
• Did I name characters?/ <i>¿Nombré a los personajes?</i>	<input type="checkbox"/>	<input type="checkbox"/>
• Did I describe characters?/ <i>¿Describí a los personajes?</i>	<input type="checkbox"/>	<input type="checkbox"/>
• Did I describe the setting?/ <i>¿Describí el ambiente?</i>	<input type="checkbox"/>	<input type="checkbox"/>
• Did I use visual aids?/ <i>¿Usé apoyo visual?</i>	<input type="checkbox"/>	<input type="checkbox"/>
• Did I use audio aids?/ <i>¿Usé apoyo auditivo?</i>	<input type="checkbox"/>	<input type="checkbox"/>

My Presentation of Narrative Text / <i>Mi presentación de un texto informativo</i>		
Name/ <i>Nombre</i> _____	Date/ <i>Fecha</i> _____	
	Yes / <i>Sí</i>	No / <i>No</i>
• Did I state the purpose of the presentation?/ <i>¿Establecí el propósito de mi presentación?</i>	<input type="checkbox"/>	<input type="checkbox"/>
• Did I introduce the topic?/ <i>¿Presenté el tema?</i>	<input type="checkbox"/>	<input type="checkbox"/>
• Did I provide background information for the topic?/ <i>¿Proporcione antecedentes para el tema?</i>	<input type="checkbox"/>	<input type="checkbox"/>
• Did I present the main ideas in appropriate sequence?/ <i>¿Presenté las ideas principales en secuencia apropiada?</i>	<input type="checkbox"/>	<input type="checkbox"/>
• Did I include descriptive details when appropriate?/ <i>¿Incluí detalles descriptivos cuando era apropiado?</i>	<input type="checkbox"/>	<input type="checkbox"/>
• Did I have a strong closing statement?/ <i>¿Tuve una conclusión eficaz?</i>	<input type="checkbox"/>	<input type="checkbox"/>
• Did I use visual aids: diagrams, charts, graphs, maps, timelines, illustrations, artifacts, models?/ <i>¿Usé apoyo visual: diagramas, cuadros, tablas, mapas, organizadores gráficos, ilustraciones, artefactos, modelos?</i>	<input type="checkbox"/>	<input type="checkbox"/>
• Did I use sound effects when appropriate?/ <i>¿Usé efectos sonoros en los momentos apropiados?</i>	<input type="checkbox"/>	<input type="checkbox"/>
• Did I share enough knowledge about the topic?/ <i>¿Compartí suficiente información sobre el tema?</i>	<input type="checkbox"/>	<input type="checkbox"/>

Appendix B

Prepare and Share a Report—Informational Text/ Preparar y compartir un informe—Texto informativo
<p>Content Organization/Organización del contenido</p> <p>Have I / ¿He</p> <ul style="list-style-type: none"> <input type="checkbox"/> stated the purpose? / <i>establecido el propósito?</i> <input type="checkbox"/> introduced topic? / <i>presentado el tema?</i> <input type="checkbox"/> provided background information? / <i>proporcionado antecedentes?</i> <input type="checkbox"/> presented main ideas in sequence? / <i>presentado las ideas principales en secuencia?</i> <input type="checkbox"/> provided descriptive details? / <i>proporcionado detalles descriptivos?</i> <input type="checkbox"/> provided a strong concluding statement? / <i>proporcionado una conclusión eficaz?</i>
<p>Audiovisual Aids/Apoyo audiovisual</p> <p>I plan to use / He planificado usar</p> <ul style="list-style-type: none"> <input type="checkbox"/> visuals such as diagrams, charts, graphs, maps, timelines / <i>ayudas visuales tales como diagramas, cuadros, tablas, mapas, organizadores gráficos</i> <input type="checkbox"/> illustrations / <i>ilustraciones</i> <input type="checkbox"/> cue cards / <i>tarjetas de apunte para guiarse</i> <input type="checkbox"/> artifacts, models / <i>artefactos, modelos</i> <input type="checkbox"/> sound effects or backgrounds / <i>efectos sonoros ó música de fondo</i>
<p>Delivery Plans/Planes para la ejecución</p> <p>I plan to / He planificado</p> <ul style="list-style-type: none"> <input type="checkbox"/> use an engaging introduction / <i>usar una introducción eficaz para atraer la atención</i> <input type="checkbox"/> state a clear purpose for presentation / <i>establecer un propósito claro para la presentación</i> <input type="checkbox"/> speak clearly, with expression / <i>hablar de manera clara, con expresión</i> <input type="checkbox"/> look at the audience when speaking / <i>mirar a la audiencia al hablar</i> <input type="checkbox"/> have good posture / <i>tener una buena postura</i> <input type="checkbox"/> use effective gestures / <i>usar gestos eficaces</i> <input type="checkbox"/> develop an effective closing to my presentation / <i>desarrollar una conclusión eficaz para mi presentación</i> <input type="checkbox"/> present for _____ minutes / <i>presentar por _____ minutos</i>

Adapted from Manitoba Education and Training, *Grades 5 to 8 English Language Arts: A Foundation for Implementation*, Grade 5 – 387, Grade 5 – 388.

Appendix C

How We Co-operated In Our Group Work—Form A *Cómo cooperamos en nuestro grupo de trabajo—Formulario A*

Name/ *Nombre* _____ Date/ *Fecha* _____

Group Members/ *Miembros del grupo* _____

Think about how your group performed. Colour in the appropriate box. / Piensa cómo se desempeñó tu grupo. Colorea la casilla apropiada.

1. We used our time wisely and helped each other stay on task. / *Usamos el tiempo bien y nos ayudamos a mantenernos en la tarea.*

SI EMPRE	A VECES	RARA VEZ	NUNCA
----------	---------	----------	-------

2. We listened to each other. / *Escuchamos a cada uno.*

SI EMPRE	A VECES	RARA VEZ	NUNCA
----------	---------	----------	-------

3. We encouraged each other. / *Nos motivamos.*

SI EMPRE	A VECES	RARA VEZ	NUNCA
----------	---------	----------	-------

4. We contributed our ideas and opinions. / *Contribuimos con nuestras ideas y opiniones.*

SI EMPRE	A VECES	RARA VEZ	NUNCA
----------	---------	----------	-------

5. We helped all group members understand the task. / *Ayudamos a todos los miembros del grupo a comprender la tarea.*

SI EMPRE	A VECES	RARA VEZ	NUNCA
----------	---------	----------	-------

6. We shared the workload. / *Compartimos la cantidad de trabajo.*

SI EMPRE	A VECES	RARA VEZ	NUNCA
----------	---------	----------	-------

7. We helped each other focus on the work. / *Nos ayudamos a concentrarnos en la tarea.*

SI EMPRE	A VECES	RARA VEZ	NUNCA
----------	---------	----------	-------

One difficulty our group had was / *Una dificultad que nuestro grupo tuvo fue*

To solve this difficulty we / *Para solucionar esta dificultad nosotros*

Appendix D

Group Work Assessment — Form B / Evaluación del trabajo en grupo — Formulario B

Name/ Nombre _____ Date/ Fecha _____

Group Members/ Miembros del grupo _____

Think about how your group performed. Colour in the appropriate box. / Piensa cómo se desempeñó tu grupo. Colorea la casilla apropiada.

1. We listened to each other's opinions and ideas. /
Escuchamos las opiniones e ideas de cada uno.

SI EMPRE	A VECES	RARA VEZ	NUNCA
----------	---------	----------	-------

2. We disagreed politely. / *Discrepamos cortésmente.*

SI EMPRE	A VECES	RARA VEZ	NUNCA
----------	---------	----------	-------

3. We used our time effectively. / *Usamos el tiempo eficazmente.*

SI EMPRE	A VECES	RARA VEZ	NUNCA
----------	---------	----------	-------

*What did you or members of your group do to create group harmony? /
¿Qué hiciste tú o qué hicieron los miembros de tu grupo para crear armonía en el grupo?*

- ☞
- ☞
- ☞
- ☞

Appendix E

How Was My Group Work? Middle Years *¿Cómo fue el trabajo de mi grupo?*

Name/Nombre _____ Date/Fecha _____

Group Members/Miembros del grupo _____

Check one. /
Marca una.

Yes / No /
Sí No

In my group, I did very well in: /
En mi grupo, me fue muy bien en:

I contributed ideas. / <i>Aporté ideas.</i>		
I listened to others. / <i>Escuché a otros.</i>		
I asked questions. / <i>Hice preguntas.</i>		
I encouraged others. / <i>Motivé a otros.</i>		
I disagreed politely. / <i>Discrepé cortésmente.</i>		
I stayed on task. / <i>Me mantuve en la tarea.</i>		

-
-
-
-

My goals for the next time are: /
Mis objetivos para la próxima vez son:

-
-
-
-

The steps I need to take to reach my goals are: /
Los pasos que debo seguir para alcanzar mis objetivos son:

-
-
-
-

The resources I need to achieve my goals are: /
Los recursos que necesito para lograr mis objetivos son:

-
-
-
-

Notes

YEAR 2

Applications	3
Language Competence	19
Global Citizenship	49
Strategies	65

APPLICATIONS
YEAR 2



Applications

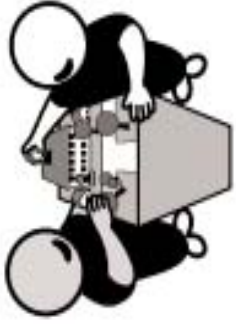

express emotions and personal perspectives

impart and receive information

get things done

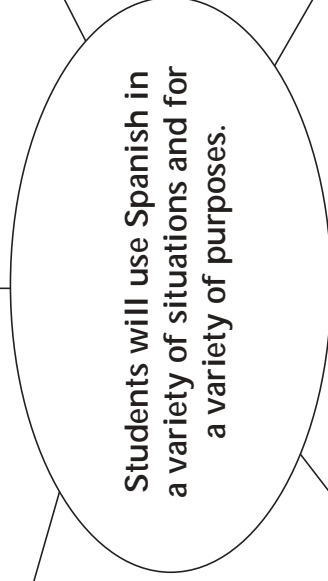

use the language for imaginative purposes and personal enjoyment

form, maintain, and change interpersonal relationships

extend their knowledge of the world



APPLICATIONS

General Outcome 1: Students will use Spanish in a variety of situations and for a variety of purposes.

The specific outcomes under the heading Applications deal with **what** the students will be able to do with the Spanish language, that is, the **functions** they will be able to perform and the **contexts** in which they will be able to operate. This functional competence, also called actional competence, is important for a content-based or task-based approach to language learning where students are constantly engaged in meaningful tasks (Celce-Murcia, Dörnyei, and Thurrell).

The functions are grouped under six cluster headings—see the illustration on the preceding page. Under each of these headings, there are one or more strands. Each strand deals with a specific language function (e.g., share factual information). Students at any grade level will be able to share factual information. Beginning learners will do this in very simple ways (e.g., “This is my dog.”). As students gain more knowledge and experience, they will broaden the range of subjects they can deal with, they will learn to share information in writing as well as orally, and they will be able to handle formal and informal situations.

Different models of communicative competence have organized language functions in a variety of ways. The organizational structure chosen here reflects the needs and interests of students in a classroom where activities are focused on meaning and are interactive. For example, the strand entitled **manage group actions** has been included to ensure that students acquire the language necessary to function independently in small groups, since this is an effective way of organizing second language classrooms. The strands under the cluster heading **to extend their knowledge of the world** will accommodate a content-based approach to language learning where students learn content from another subject area as they learn the Spanish language.

The level of linguistic, sociolinguistic, and discourse competence that students will exhibit when carrying out the functions is defined in the specific outcomes for Language Competence for each course. To know how well students will be able to perform the specific function, the Applications outcomes must be read in conjunction with the Language Competence outcomes.



PRESCRIBED OUTCOMES	SUGGESTIONS FOR INSTRUCTION
<p>General Outcome 1: Applications Students will use Spanish in a variety of situations and for a variety of purposes.</p> <p>1.1 impart and receive information</p> <p>1.1.1 <i>Share Factual Information</i></p> <ul style="list-style-type: none">❖ ask for and provide information❖ respond to simple, predictable questions❖ describe people, places, things <p>1.2 express emotions and personal perspectives</p> <p>1.2.1 <i>Share Ideas, Thoughts, Opinions, Preferences</i></p> <ul style="list-style-type: none">❖ identify favourite people, places, or things❖ express a personal response to a variety of situations	<p>➤ Form groups and give each a city map, subway map, or a train or bus schedule written in Spanish. Suggest that each group plan a journey. Then ask each group member to record travel details in a note for a friend who will meet the group at a particular destination (BC <i>Resource Package</i>, 46).</p> <p>➤ Ask students in pairs to role-play making arrangements for meetings with friends. Have partners ask each other questions to elicit information regarding times, places, and dates, using the following patterns (BC <i>Resource Package</i>, 28):</p> <ul style="list-style-type: none">• ¿Cuándo?• ¿A qué hora?• ¿Dónde? <p>➤ Play “Information Search,” using the following question: ¿A quién le gusta _____? Use pictures to indicate the items or activities to be discussed. Have students ask each other about their likes and dislikes. They should try to find at least three people who have the same likes as they do. They fill out a bingo card with the name of the person who likes the item or activity.</p>



SUGGESTIONS FOR ASSESSMENT

SUGGESTED LEARNING RESOURCES

- After students have worked in groups to prepare travel details, have them exchange their plans with other groups, who then provide feedback about the extent to which
 - the information is clear
 - the sequence of instructions is logical
 - key details such as departure and arrival times are included

- Observe role-playing activities for evidence that students are increasingly able to
 - make themselves understood in Spanish
 - use learned patterns and vocabulary (language competence, attend to form)
 - take risks to add details or unfamiliar language
 - use strategies such as non-verbal communication and visual props to support their messages (strategies)
 - be accurate

(See role-play assessment criteria in Classroom Assessment, p. 11.)

- When students play “Information Search,” look for evidence that they
 - interact with each other
 - use Spanish
 - are able to respond to the teacher’s question:
¿A quién le gusta?

- Dos Mundos*
Student Edition
- ¡Dime! Uno*
Unidad 5, Lección 1
- ¡Buen Viaje!*
Capítulo 11
A escuchar: segunda parte
Actividad a
- ¡En español! 1A*
Unidad 3, Etapa 1
Actividad 8
- ¡Dime! Uno*
Unidad 2, Lección 1
- ¡Dime! Uno*
Unidad 3, Lección 1
Pair Activity
- Chicas Chicas, Nivel 1*
Unidad 7, Lección 13



SUGGESTIONS FOR ASSESSMENT

SUGGESTED LEARNING RESOURCES

- When students prepare a role play based on simple problem and solution, using emotions, look for evidence that students are increasingly able to
 - inquire about and express emotions and feelings
 - make themselves understood in Spanish
 - use learned patterns and vocabulary (language competence, attend to form)
 - take risks to add details or use unfamiliar language
 - use strategies such as non-verbal communication and visual props to support their messages (strategies)
 - recognize and respond to familiar words and patterns

(See role-play assessment criteria in Classroom Assessment, p. 11.)

- When students interact to find emotions of family members, look for evidence that they
 - interact with several classmates
 - use Spanish throughout the activity
 - illustrate emotions effectively



PRESCRIBED OUTCOMES	SUGGESTIONS FOR INSTRUCTION
<p>1.3 get things done</p> <p>1.3.1 <i>Guide Actions of Others</i></p> <ul style="list-style-type: none">❖ suggest a course of action, and respond to a suggestion❖ make and respond to a variety of simple requests❖ seek, grant, or withhold permission <p>1.3.2 <i>State Personal Actions</i></p> <ul style="list-style-type: none">❖ indicate choice from among several options❖ express a wish or a desire to do something <p>1.3.3 <i>Manage Group Actions</i></p> <ul style="list-style-type: none">❖ ask for help or clarification of what is being said or done in the group❖ suggest, initiate, or direct action in group activities	<p>➤ Divide the class into groups. Have each group learn a game played in the Spanish-speaking world (e.g., <i>cartas, dados, dominós</i>). Have each group teach the class the game it has learned, using as many Spanish expressions as possible (e.g., <i>A tí te toca, tira los dados</i>). As an extension, have students invite community members to participate in a Spanish Day, when the games could be played (BC <i>Resource Package</i>, 42).</p> <p>➤ Have students work in pairs. Provide students with two scenes with several differences. Have students describe their scene to their partner without looking at each other's scenes. The goal is for students to discover how their scenes are different by describing the actions that are a part of their particular scene.</p> <p>➤ Have students describe in written form all of the activities they carry out in a given situation (e.g., a shopping trip that involves stops at various types of stores).</p> <p>➤ Have students work in groups of three.</p> <ul style="list-style-type: none">• Student 1—mimes an action• Student 2—orally describes action to student 3, using the imperative or present progressive• Student 3—writes down the action <p>Students clarify the described situation with other group members or ask for help understanding or writing what was said.</p> <p>➤ Using a map of a Spanish-speaking city, give students a variety of directions to particular destinations in the city. After having followed the directions, students respond to the question, <i>¿Dónde estás?</i></p>



SUGGESTIONS FOR ASSESSMENT

SUGGESTED LEARNING RESOURCES

- When students teach one another games they have learned, encourage them to use Spanish as much as possible. Establish criteria for group feedback such as the following:
 - demonstration is clear and easy to follow
 - demonstration was successful; the other students learned the game
 - language associated with the activity is used accurately (language competence, attend to form)
 - comparisons to familiar games or activities help to develop understanding (global citizenship, affirming diversity)

- When students describe scenes to each other or describe activities in written form, look for evidence that they are able to
 - correctly identify the differences
 - use a variety of action verbs (language competence, attend to form)
 - conjugate verbs correctly with the third person singular (language competence, grammar)
 - use descriptors to enhance their written text (language competence, attend to form)

- When students are using maps to give and follow directions to various destinations, observe that students are
 - using Spanish to give clear directions
 - using appropriate vocabulary expressions
 - able to arrive at the proper destinations

- ¡Buen Viaje! 2*
 Capítulo 10
 Expansion Activities, p. 61
- ¡Dime! Uno*
 Unidad 8, Lección 3
 Video
-
- ¡En español! 1A*
 Más comunicación
 Actividad 10, ¿Doble Vision?
- ¡Dime! Uno*
 Unidad 3
-
-
-
- ¡En español! 1A*
 Unidad 4, Etapa 1
- ¡Dime! Uno*
 Unidad 5, Lección 1
- Planet@ 1*
 Tema 2, Órbita 1



PRESCRIBED OUTCOMES	SUGGESTIONS FOR INSTRUCTION
<p>1.4 extend their knowledge of the world</p> <p>1.4.1 <i>Discover and Explore</i></p> <ul style="list-style-type: none">❖ investigate the immediate environment❖ make and talk about personal observations <p>1.4.2 <i>Gather and Organize Information</i></p> <ul style="list-style-type: none">❖ sequence items in different ways ❖ record and share personal knowledge of a topic <p>1.4.3 <i>Solve Problems</i></p> <ul style="list-style-type: none">❖ choose between alternative solutions❖ define a problem, and search for solutions	<p>➤ Have students do a personal interview with a partner.</p> <p>➤ Have students work in pairs or in small groups to identify the important qualities of a good friend. Have students decide on the top three qualities of a good friend. Discuss with the class and come to a consensus as a whole class.</p> <p>➤ Invite students to form small groups to brainstorm reasons that people choose to become vegetarians.</p> <p>After a class discussion, ask students to complete a questionnaire on personal eating habits. Information gathered may be used to create articles or displays (BC <i>Resource Package</i>, 68).</p> <p>➤ Have students watch a video about a problematic situation in a restaurant. Have students identify the problem and discuss possible solutions.</p> <p>➤ Form groups of four and have each group discuss the</p>



SUGGESTIONS FOR ASSESSMENT

SUGGESTED LEARNING RESOURCES

- When students work in pairs or small groups to identify the important qualities of a good friend, look for evidence that they are able to
 - organize and categorize (qualities of a friend)
 - use a variety of adjectives with correct gender (language competence, attend to form)
 - use basic comparative expressions such as *más importante que/menos importante que* (language competence, attend to form)

- When students examine issues such as vegetarianism, look for evidence for the extent to which they
 - take positions
 - give relevant reasons to support their arguments
 - listen actively and attempt to respond to or build on others' ideas
 - participate in the discussion using Spanish

- When students watch a video and work to identify the problem and possible solutions, observe their ability to
 - participate in the discussion
 - recognize the problem
 - offer logical solutions with justifications

¡Dime! Uno
Unidad 1, Lección 3

¡Dime! Uno
Unidad 5, Lección 3



PRESCRIBED OUTCOMES	SUGGESTIONS FOR INSTRUCTION
<p>1.4 extend their knowledge of the world (continued)</p> <p>1.4.4 <i>Explore Opinions and Values</i></p> <ul style="list-style-type: none">❖ make connections between behaviour and values (e.g., in texts or role play)❖ recognize differences of opinion	<p>purchase of a gift for a friend, family members, or teacher. Ask groups to arrive at a consensus on their gift choices and state reasons to support them (BC <i>Resource Package</i>, 52).</p>
<p>1.5 imaginative purposes and personal enjoyment</p> <p>1.5.1 <i>Humour/Fun</i></p> <ul style="list-style-type: none">❖ manipulate words or phrases to express humour	<p>➤ Provide students with several humorous expressions related to food and restaurants. Have students either use these expressions in a role play or have them illustrate the expressions. Display the illustrations in the class and have students guess which expression corresponds with each illustration (e.g., <i>Anda a freír espárragos</i>).</p>
<p>1.5.2 <i>Creative/Aesthetic Purposes</i></p> <ul style="list-style-type: none">❖ use the language creatively (e.g., create a picture story with captions)	<p>➤ Have students create a <i>patio de comidas</i> (Food Court) in class. Have students work in groups to prepare a menu for their mini-restaurant as well as possible food samples.</p>



SUGGESTIONS FOR ASSESSMENT	SUGGESTED LEARNING RESOURCES
<p>➤ When students participate in interactions such as discussing the purchase of a gift, look for evidence that they are able to</p> <ul style="list-style-type: none"> • present their opinions • respond appropriately to questions and cues from others • include reasons, details, and examples to support their views • use appropriate vocabulary and structures 	<p><i>¡En español! 1A</i> Unidad 4, Etapa 1</p> <p><i>¡Dime! Uno</i> Unidad 5, Lección 1</p> <p><i>¡Dime! Uno</i> Unidad 5, Lección 2 Video</p>
<p>➤ When students illustrate humorous expressions related to food, look for evidence that students are able to</p> <ul style="list-style-type: none"> • create an illustration that corresponds with the meaning of the expression • create a visually appealing illustration • take risks to be original and creative 	<p><i>101 Spanish Idioms</i> Sección 3 Algo en que pensar</p>
<p>➤ When students work in groups to organize a menu and <i>patio de comidas</i>, look for evidence that they are</p> <ul style="list-style-type: none"> • participating actively • making an effort to use Spanish 	<p><i>¡Dime! Uno</i> Unidad 5, Lección 3</p> <p>Internet</p>
<p>➤ When students create their own menu for a mini-restaurant as part of a food court, establish criteria with students before they begin. Criteria might include the following</p> <ul style="list-style-type: none"> • menu is organized in a typical menu format (language competence, written production) • vocabulary related to food and menus is incorporated (language competence, written production and attend to form) • correct use of illustrations to enhance understanding (strategies, language use strategies) 	



PRESCRIBED OUTCOMES	SUGGESTIONS FOR INSTRUCTION
<p>1.5 imaginative purposes and personal enjoyment (continued)</p> <p>1.5.2 <i>Creative/Aesthetic Purposes (continued)</i></p> <ul style="list-style-type: none">❖ use the language creatively (e.g., create a picture story with captions) <p>1.5.3 <i>Personal Enjoyment</i></p> <ul style="list-style-type: none">❖ use the language for personal enjoyment (e.g., make a collection of pictures or artifacts related to a Spanish culture)	<ul style="list-style-type: none">➤ Invite students to participate in an outing to a restaurant. ➤ Have students watch a Spanish movie, read a piece in Spanish, or travel to a Spanish-speaking area/country.
<p>1.6 form, maintain, and change interpersonal relationships</p> <p>1.6.1 <i>Manage Personal Relationships</i></p> <ul style="list-style-type: none">❖ initiate relationships (e.g., invite others to play)❖ apologize and refuse politely	<ul style="list-style-type: none">➤ Students role-play inviting someone to a movie or a party. The person already has plans so that person apologizes to them and declines politely.



SUGGESTIONS FOR ASSESSMENT

SUGGESTED LEARNING RESOURCES

- When students participate in an outing to a Spanish restaurant, look for evidence that they
 - have a positive attitude
 - use Spanish
 - use vocabulary related to food and restaurants

- After having watched a movie, read a piece in Spanish, or travelled to a Spanish-speaking country, students self-evaluate. Students answer questions such as, “What did I like, dislike, and why?”

- Observe role-playing activities for evidence that students are able to
 - use appropriate language to initiate interaction
 - use appropriate language to decline politely

(See role-play assessment criteria in Classroom Assessment, p. 11.)



Notes

*LANGUAGE
COMPETENCE
YEAR 2*



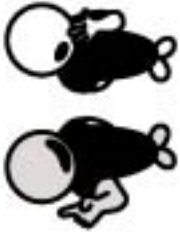

Language Competence

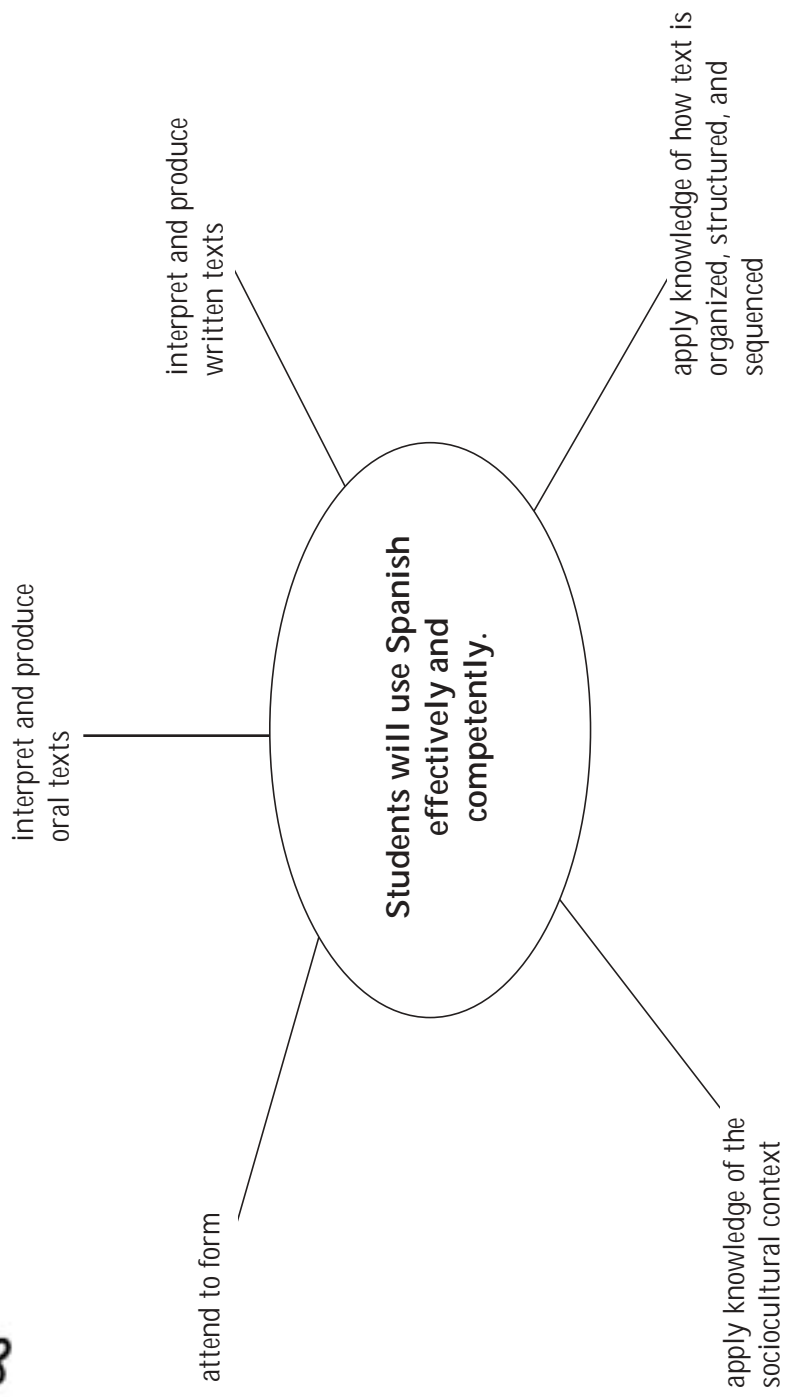



LANGUAGE COMPETENCE

General Outcome 2: Students will use Spanish effectively and competently.

Language competence is a broad term that includes linguistic or grammatical competence, discourse competence, sociolinguistic or sociocultural competence, and what might be called textual competence. The specific outcomes under Language Competence deal with knowledge of the Spanish language and the ability to use that knowledge to interpret and produce meaningful texts appropriate to the situation in which they are used. Language competence is best developed in the context of activities or tasks where the language is used for real purposes, in other words, in practical **applications**.

The various components of language competence are grouped under four cluster headings—see the illustration on the preceding page. Under each of these headings there are several strands. Each strand deals with a single aspect of language competence. For example, under the cluster heading **attend to form**, there is a strand for phonology (pronunciation, stress, intonation), orthography (spelling, mechanical features), lexicon (vocabulary words and phrases), and grammatical elements (syntax and morphology).

Although the outcomes isolate these individual aspects, language competence should be developed through learning activities that focus on meaningful uses of the Spanish language and on **language in context**. Tasks will be chosen based on the needs, interests, and experiences of students. The vocabulary, grammar structures, text forms, and social conventions necessary to carry out a task will be taught, practised, and assessed as students are involved in various aspects of the task itself, **not in isolation**.

Strategic competence is often closely associated with language competence, since students need to learn ways to compensate for low proficiency in the early stages of learning if they are to engage in authentic language use from the beginning. This component is included in the language use strategies in the Strategies section.



PRESCRIBED OUTCOMES	SUGGESTIONS FOR INSTRUCTION
<p>General Outcome 2: Language Competence Students will use Spanish effectively and competently.</p> <p>2.1 attend to form</p> <p>2.1.1 <i>Phonology</i></p> <ul style="list-style-type: none">❖ distinguish particular sounds of the language ❖ use comprehensible pronunciation, stress, and intonation when producing familiar words or phrases <p>2.1.2 <i>Orthography</i></p> <ul style="list-style-type: none">❖ write familiar words, phrases, and sentences❖ recognize and use some basic mechanical conventions (e.g., capitalization, punctuation)	<p>➤ Provide students with a list of familiar words or phrases and have them read them, focusing on correct pronunciation, stress, and intonation (e.g., <i>plátano, jamón, café</i>, etc.).</p> <p>➤ First, model the use of specific sound distinctions in two sentences where meaning is changed as a result of pronunciation, and ask students to identify the differences. Then, provide a list of vocabulary to focus on the sounds representing specific letters (e.g., <i>e/i, g/j, ll, ñ, r, z</i>) in the following situations:</p> <ul style="list-style-type: none">• At the doctor’s office: A doctor’s visit in Spain, Argentina, Cuba, etc.• Social life: Role-play an interview with an exchange student from Spain, Argentina, Mexico, etc. <p>➤ Compare capitalization rules for French/English and Spanish (e.g., months, days of the week, nationalities, titles, etc.), using supporting texts from books, Internet, etc.</p>



SUGGESTIONS FOR ASSESSMENT

SUGGESTED LEARNING RESOURCES

- Look for evidence that students are able to pronounce correctly, based on common rules.

- Prepare an observation checklist. Observe the students' ability to reproduce appropriately in context the following critical sound distinctions:
 - *i/e*
 - *g/j*
 - *ll*
 - *ñ*
 - *r*
 - *z*

- Look for evidence that students are able to apply Spanish rules of capitalization and punctuation in their written work.

Colección tiempo: Para pronunciar



PRESCRIBED OUTCOMES	SUGGESTIONS FOR INSTRUCTION
<p>2.1 attend to form (continued)</p> <p>2.1.3 <i>Lexicon</i></p> <ul style="list-style-type: none">❖ use a repertoire of words and phrases in familiar contexts that meet the needs and interests of students, particularly within the following areas of experience:<ul style="list-style-type: none">— introduction to fashion (shopping)— activities<ul style="list-style-type: none">✓ in the home✓ in the community— places and transportation— foods and cuisine<ul style="list-style-type: none">✓ restaurants✓ market— sports and exercise— friendship— introduction to cultural diversity in the Spanish-speaking world	<ul style="list-style-type: none">➤ Students practice target vocabulary by playing games such as “Hangman” (“<i>El ahorcado</i>”), spelling bee, etc.



SUGGESTIONS FOR ASSESSMENT

- Look for evidence that students spell target vocabulary accurately in a variety of situations.

SUGGESTED LEARNING RESOURCES

USO interactivo del vocabulario
Rosetta Stone I and II



PRESCRIBED OUTCOMES	SUGGESTIONS FOR INSTRUCTION
<p>2.1 attend to form (continued)</p> <p>2.1.4 <i>Grammatical Elements</i></p> <ul style="list-style-type: none">❖ use, in modelled situations, the following grammatical elements:<ul style="list-style-type: none">— <i>nos/les (os) gusta/an</i>— <i>caer bien/mal</i>— possessive adjectives and pronouns: <i>nuestro/a/os/as, vuestro/a/os/as</i>— irregular verbs: <i>poder, conocer, saber, venir, salir, decir, hacer, preferir</i>— commands—regular verbs (<i>tú</i> form)— commands for commonly used verbs (<i>usted, ustedes</i>)— present progressive (<i>estar + gerund</i>)	<p>Modelled Situations: This term is used to describe learning situations where a model of specific grammatical elements is consistently provided and immediately available. Students in such situations will have an emerging awareness of the grammatical elements and be able to apply them in very limited situations. Limited fluency and confidence characterize student language.</p> <p>Example of a modelled situation:</p> <p>In preparation for a group project, students will keep a journal of their daily activities for a week. Students practise the structure “<i>tener que + infinitive</i>” using the sentence patterns provided. Each student asks five classmates, <i>¿Qué tienes que hacer después de clases hoy?</i> Students answer saying, <i>Tengo que . . .</i>, with an infinitive of their choice. Each person then summarizes the results of their mini survey, <i>Tres estudiantes tienen que estudiar</i>, and so on.</p>



SUGGESTIONS FOR ASSESSMENT

**SUGGESTED LEARNING
RESOURCES**

*USO de la gramática española:
Junior intermedio*

Colección tiempo: Para conjugar

Rosetta Stone I and II



PRESCRIBED OUTCOMES	SUGGESTIONS FOR INSTRUCTION
<p>2.1 attend to form (continued)</p> <p>2.1.4 <i>Grammatical Elements (continued)</i></p> <ul style="list-style-type: none">❖ use, in structured situations, the following grammatical elements:<ul style="list-style-type: none">— <i>me/te/le gusta/an</i>— commonly used verbs: <i>ir, querer</i>— regular <i>ir</i> and <i>er</i> verbs in the present tense— <i>tener que</i> + infinitive— <i>ir + a</i> + infinitive— definite and indefinite articles: <i>el, la, lo, las, los, un, una, unas, unos</i>— possessive adjectives: <i>mi, tu, su, mis, tus, sus</i>— demonstrative adjectives and pronouns: <i>este/a, ese/a, aquel/la, estos/as, esos/as, aquellos/as</i>	<p>Structured Situations: This term is used to describe learning situations where a familiar context for the use of specific grammatical elements is provided and students are guided in their use. Students in such situations will have increased awareness and emerging control of the grammatical elements and be able to apply them in familiar contexts with teacher guidance. Student language is characterized by increasing fluency and confidence.</p> <p>Example of a structured situation:</p> <p>In preparation for a research project on typical activities of young people in selected Spanish-speaking countries, students listen to a rapid conversation where a Canadian student is talking to an exchange student from Mexico. The students check off, on a prepared answer sheet, what the exchange student does and does not do.</p>



SUGGESTIONS FOR ASSESSMENT

**SUGGESTED LEARNING
RESOURCES**

*USO de la gramática española:
Junior intermedio*

Colección tiempo: Para conjugar

Rosetta Stone I and II



PRESCRIBED OUTCOMES	SUGGESTIONS FOR INSTRUCTION
<p>2.1 attend to form (continued)</p> <p>2.1.4 <i>Grammatical Elements (continued)</i></p> <ul style="list-style-type: none">❖ use, in independent situations, the following grammatical elements:<ul style="list-style-type: none">— subject pronouns: <i>yo, tú, él, ella, usted, nosotros/as, vosotros/as, ustedes</i>— affirmative/negative/interrogative sentences in the present tense— regular <i>-ar</i> verbs in the present tense— gender and number of nouns, adjectives— commonly used verbs: <i>ser, estar, tener</i>	<p>Independent Situations: This term is used to describe learning situations where students use specific grammatical elements in a variety of contexts with limited teacher guidance. Students in such situations will have consistent control of the grammatical elements and be able to apply them in a variety of contexts with limited teacher guidance. Fluency and confidence characterize student language.</p> <p>Example of an independent situation: Students send a letter, an email message, or a recorded message to a Spanish-speaking pen pal explaining what they do regularly.</p>



SUGGESTIONS FOR ASSESSMENT

**SUGGESTED LEARNING
RESOURCES**

*USO de la gramática española:
Junior intermedio*

Colección tiempo: Para conjugar

Rosetta Stone I and II



PRESCRIBED OUTCOMES	SUGGESTIONS FOR INSTRUCTION
<p>2.2 interpret and produce oral texts</p> <p>2.2.1 <i>Aural Interpretation</i></p> <ul style="list-style-type: none">❖ understand short, simple texts in guided situations	<ul style="list-style-type: none">➤ Have students form groups of four. Provide students with a song, excerpt from a conversation, or TV/radio ad. Have students first discuss what kind of information they might be hearing in the upcoming text, based on their knowledge of what is found in a radio or TV ad, etc. Then have students listen to the excerpt and take notes. Students then discuss in their groups what they understood and what strategies they might use to understand the information they were unable to glean after the first listening. Provide students with one or two strategies. Play the excerpt two or three times and discuss with students what they were able to understand and the strategies they used to help their understanding.➤ Read a simple short story to students. After listening to the story, students write a sentence or draw a picture that interprets what they have understood. In groups or as a class, discuss the interpretations. Read the story out loud a final time and have students respond to comprehension questions in written form.



SUGGESTIONS FOR ASSESSMENT

- As students work in groups to understand short texts, look for evidence that they are able to
 - listen for key words
 - use key words and context to create meaning
 - use listening strategies to aid in understanding

- When students illustrate what they have understood about a simple short story, look for evidence that they are able to
 - explain their drawings to their group or to the class as a whole
 - make connections between the story and their sentence or drawing

SUGGESTED LEARNING RESOURCES

Colección tiempo: Para comprender
 Mensajes orales de la vida cotidiana



PRESCRIBED OUTCOMES	SUGGESTIONS FOR INSTRUCTION
<p>2.2 interpret and produce oral texts (continued)</p> <p>2.2.2 <i>Oral Production</i></p> <ul style="list-style-type: none">❖ produce simple sentences in guided situations	<ul style="list-style-type: none">➤ Provide students with several situations related to themes studied in class (e.g., going to a restaurant, meeting a friend, etc.). Have students create a simple story book using one of the scenarios. Students must illustrate the book and prepare a cassette (soundtrack), in which they read the story, to accompany the book. Students then present the storybook, with accompanying soundtrack, to the class. Provide students with a story map to help them organize their ideas as well as checklists for self and peer assessment.
<p>2.2.3 <i>Interactive Fluency</i></p> <ul style="list-style-type: none">❖ engage in simple interactions, using simple sentences	<ul style="list-style-type: none">➤ Provide students with videos or reading materials that portray market scenes in a Spanish-speaking region. Then have students in pairs role-play visits to markets or stores. Ask students to take turns playing customer and vendor. Encourage students to discuss the articles being bought and the prices they are willing to pay (BC <i>Resource Package</i>, 36).



SUGGESTIONS FOR ASSESSMENT

SUGGESTED LEARNING RESOURCES

- When students prepare a storybook with an accompanying soundtrack, provide students with a story map to help them organize their ideas as well as checklists for self and peer assessment.

An Oral Presentation Checklist might include the following:

- story makes sense/has meaning
- pronunciation and intonation are generally accurate (language competence, attend to form)
- expression is used to enhance communication of ideas (language competence, attend to form)

A Representation Checklist might include the following:

- sound track is effective in representing feelings and themes of story
- good use of music and/or sound effects to support story
- illustrations correspond to written text and to music/sound effects

- When students role-play visits to markets or stores in Spanish-speaking regions or replying to classified ads, note the extent to which they are able to

- provide clear messages
- use appropriate patterns and frames for giving directions and prices/prices and descriptions
- adjust and clarify when miscommunication occurs
- use intonation, miming, gestures, and body language to support communication (strategies)
- speak clearly and smoothly, using approximate Spanish pronunciation (language competence, attend to form)

(See role-play assessment criteria in Classroom Assessment, p. 11.)

España Viva
Video Course
Video 1
Episode 2, 3

Destinos: An Introduction to Spanish
Video Series
Episode 4



PRESCRIBED OUTCOMES	SUGGESTIONS FOR INSTRUCTION
<p>2.2 interpret and produce oral texts (continued)</p> <p>2.2.3 <i>Interactive Fluency (continued)</i></p> <ul style="list-style-type: none">❖ engage in simple interactions, using simple sentences	<ul style="list-style-type: none">➤ Have students role-play a variety of situations outlined on scenario cards they draw. For example, a tourist wants to cash a traveller’s cheque at 1:50 p.m., but the bank refuses to cash it because closing time is 2:00 p.m.; a hungry tourist wishes to eat at 8:00 p.m., but the restaurant doesn’t serve meals before 10:00 p.m.; a tourist tries to buy fruit at a market stand at 2:00 p.m., but the vendor has gone because it is a three-hour bus ride home; a local invites a tourist to Midnight Mass; a group of business people discover they are on the wrong bus (BC <i>Resource Package</i>, 58).➤ Invite students to role-play a variety of common situations, allowing time for preparation but not for memorizing a script. Situations might include telephoning for take-out food, renting a video, purchasing a ticket (BC <i>Resource Package</i>, 60).➤ Ask students to examine the classified section of a Spanish-language newspaper to find items they need or want to purchase (e.g., computers, mountain bikes, sports equipment). Students then role-play and reply to the advertisements, refer to specific information in them, and ask relevant questions (BC <i>Resource Package</i>, 62).



SUGGESTIONS FOR ASSESSMENT

- When students role-play with minimum preparation, look for evidence that
 - language is understandable and appropriate to the context
 - statements are logical and relate to the situation
 - reactions, including intonation, are appropriate
 - speech is reasonably fluid
 - strategies are used effectively to clarify meaning and sustain interaction

(See role-play assessment criteria in Classroom Assessment, p. 11.)

SUGGESTED LEARNING RESOURCES

¡En español! 2
 Unidad 6, Etapa 1
 Video: En vivo



PRESCRIBED OUTCOMES	SUGGESTIONS FOR INSTRUCTION
<p>2.3 interpret and produce written texts</p> <p>2.3.1 <i>Written Interpretation</i></p> <ul style="list-style-type: none">❖ understand short, simple texts in guided situations <p>2.3.2 <i>Written Production</i></p> <ul style="list-style-type: none">❖ produce simple sentences in guided situations <p>2.3.3 <i>Visual Interpretation</i></p> <ul style="list-style-type: none">❖ derive meaning from a variety of visuals and other forms of non-verbal communication in guided situations	<p>➤ Have students work individually or in groups to respond to questions from the short stories series <i>Easy Spanish Reader</i>.</p> <p>➤ Have students form groups of three or four. Provide students with a simple text that has been divided into three or four sections. (Each section may be only three or four sentences in length.) For the first part of the activity, give each group a section of the text. Each member of the group has the same part of the text. Students read their section of the text together and discuss. Students then regroup into new groups where each member of the group has a different part of the text (jigsaw). Students read text together, put it into the correct order, and then present the main ideas of the text. They may either illustrate, present an oral summary, or prepare a written summary.</p> <p>➤ Provide students with pictures that accompany a simple story. Allow students to create their own simple story individually or in groups, based on the pictures provided.</p> <p>Provide students with a story map to help them organize their ideas.</p> <p>After the completion of their own versions of the story, read to students the actual story that accompanies the pictures.</p>



SUGGESTIONS FOR ASSESSMENT

SUGGESTED LEARNING RESOURCES

- When students respond to questions from a series, look for evidence that they are able to answer questions in one word or in a short sentence.
- When students participate in a jigsaw activity to understand a simple text, look for evidence that they are able to
 - discuss the information within the text with group members, providing main ideas
 - present the main ideas of the text in an organized and logical sequence (language competence, production—written or oral)

- When students create their own story, based on pictures provided, provide students with a story map to help them organize their ideas. Observe the extent to which they are able to
 - use the pictures to make sense of the story
 - organize their story in a meaningful way
 - compare and contrast their stories to the actual stories

¡Buen Viaje! 1
 Lecturas
 Culturales
 Conexiones

¡Dime! Uno
 Unidad 6, Lección 1 y 3
 Charlemos un poco más



PRESCRIBED OUTCOMES	SUGGESTIONS FOR INSTRUCTION
<p>2.3 interpret and produce written texts (continued)</p> <p>2.3.4 <i>Representation</i></p> <ul style="list-style-type: none">❖ use a variety of visuals and other forms of non-verbal communication to express meaning in guided situations	<p>➤ Have students create a comic strip. Students can present their story as a power point presentation or they may dramatize their story.</p>
<p>2.4 apply knowledge of the sociocultural context</p> <p>2.4.1 <i>Register</i></p> <ul style="list-style-type: none">❖ use simple forms of formal and informal register with guidance (e.g., <i>usted/tú</i>)❖ recognize that some topics, words, or intonations are inappropriate in certain contexts	<p>➤ Have students view a simple video and have them note when characters use <i>tú</i> and when they use <i>usted</i>.</p>



SUGGESTIONS FOR ASSESSMENT

SUGGESTED LEARNING RESOURCES

- A Written Presentation Checklist might include the following:
 - story makes sense/has meaning
 - ideas are clear and logical/details are relevant and appropriate
 - sentence structure is clear and supports communication of ideas (language competence, attend to form)
 - vocabulary is appropriate (language competence, attend to form)
 - spelling is correct (language competence, attend to form)
 - verbs are conjugated correctly, agreement of adjectives is correct (language competence, attend to form)

(See an example of a written presentation checklist in Classroom Assessment, p. 16.)

- When students view a video with situations where characters use *tú* or *usted*, look for evidence that students are able to
 - identify the types of situations in which *tú* and *usted* are used
 - explain why the formal or informal register are used

¡Dime! Uno
 Unidad 1, lección 1

¡En español! 1
 Unidad 1, Etapa 1



PRESCRIBED OUTCOMES	SUGGESTIONS FOR INSTRUCTION
<p>2.4 apply knowledge of the sociocultural context (continued)</p> <p>2.4.2 <i>Idiomatic Expressions</i></p> <ul style="list-style-type: none">❖ understand and use a variety of simple idiomatic expressions as set phrases <p>2.4.3 <i>Variations in Language</i></p> <ul style="list-style-type: none">❖ identify some major geographical variations in language (e.g., Spain, Latin America)❖ acknowledge and accept individual differences in speech <p>2.4.4 <i>Social Conventions</i></p> <ul style="list-style-type: none">❖ identify important conventions in various social interactions (e.g., shaking hands, kissing cheeks)	<p>➤ Give students a series of different words, on small cards or pieces of paper, that are used in different Spanish-speaking countries to mean the same foods. In groups have students categorize the words according to the food they think the words represent (e.g., <i>durazno</i> = <i>melocotón</i>, <i>pomelo</i> = <i>toronja</i>).</p> <p>Provide students with the correct categories, allowing them to reorganize their words if necessary.</p> <p>As an extension, students could prepare a skit at a restaurant or at the market that illustrates misunderstandings that can occur when people of different Spanish-speaking countries use different words to mean the same food items. Have students also include two to three idiomatic expressions related to eating/food/going to restaurants.</p> <p>➤ Distribute pictures or show an extract of a video that depicts people greeting each other in different ways. Discuss students' interpretation of what is happening in the pictures or video. Discuss cultural differences in greetings. As an extension, have students prepare a simple role play that depicts two people from different cultures greeting each other.</p>



SUGGESTIONS FOR ASSESSMENT

SUGGESTED LEARNING RESOURCES

- When students prepare role plays of situations in a restaurant or at the market place where misunderstandings occur due to variations in expressions, discuss criteria before students begin. Criteria might include the following:
 - appropriate use of an idiomatic expression and one pair of food expressions (e.g., *melocotón/durazno*)
 - pronunciation and intonation are generally accurate (language competence, attend to form)
 - strategies such as non-verbal communication and visual props are used to support messages (strategies)

(See role-play assessment criteria in Classroom Assessment, p. 11.)

- As students view and interpret various greetings, look for evidence that they are able to identify similarities and differences between greetings.

¡En español! 1
 Unidad 2, Etapa 3
 Unidad 4, Etapa 3

¡Buen Viaje! 1A
 Capítulo 5

¡Buen Viaje! 1B
 Capítulo 14

¡Dime! Uno
 Unidad 1, Lección 1



PRESCRIBED OUTCOMES	SUGGESTIONS FOR INSTRUCTION
<p>2.4 apply knowledge of the sociocultural context (continued)</p> <p>2.4.5 <i>Non-verbal Communication</i></p> <ul style="list-style-type: none">❖ experiment with using some simple non-verbal means of communication (e.g., nodding or shaking the head “no”)❖ recognize that some non-verbal behaviours may be inappropriate in certain contexts	<ul style="list-style-type: none">➤ Have students work in pairs to prepare a scene that includes simple dialogue and very pronounced gestures and actions. Have students present their scene with only the actions and gestures. The rest of the class must determine what is occurring and call out possible dialogue that could logically accompany the gestures of the group. Have the presenters of the scene then present the scene again with the original dialogue.➤ Encourage students to use non-verbal communication when they do not know or do not remember the word for what they are trying to attain.
<p>2.5 apply knowledge of how text is organized, structured, and sequenced</p> <p>2.5.1 <i>Cohesion/Coherence</i></p> <ul style="list-style-type: none">❖ sequence elements of a simple story, process, or series of events❖ link words or groups of words in simple ways (e.g., using words like <i>y</i>, <i>e</i>, and <i>después</i>)	<ul style="list-style-type: none">➤ Provide students with the written instructions for a recipe, but not in order. Point out words that have linking function (e.g., <i>primero</i>, <i>después</i>, <i>luego</i>, etc.). Have students put the instructions in the correct order and then do a demonstration or illustrate the steps of the recipe.➤ Provide students with only the pictures which represent the steps involved in the preparation of a recipe. Have students put the pictures in the correct order and then prepare the written instructions for each picture.



SUGGESTIONS FOR ASSESSMENT

SUGGESTED LEARNING RESOURCES

- When students prepare scenes using gestures and dialogue, discuss criteria before students begin. Criteria might include the following:

For Presenters:

- students' gestures are identifiable and clear
- dialogue is clear and follows a logical sequence
- gestures and dialogue correspond

For Audience:

- students are actively engaged in activity
- students take risks to guess what dialogue could be taking place, based on the gestures provided

- When students reorganize the steps involved in the preparation of a recipe, either in written or illustrated form, look for evidence that students are able to sequence the steps in a logical order.

When students prepare a demonstration or written instructions for the steps of a recipe, look for evidence that they are able to

- use linking words correctly
- use the imperative of *tú* or *usted* correctly (language competence, attend to form)
- give clear instructions
- use vocabulary related to cooking appropriately (language competence, attend to form)

Diccionario de gestos

¡Buen Viaje! 1A
Capítulo 7

¡Buen Viaje! 1B
Capítulo 9

¡Dime! Uno
Unidad 8, Lección 3



PRESCRIBED OUTCOMES	SUGGESTIONS FOR INSTRUCTION
<p data-bbox="103 281 558 386">2.5 apply knowledge of how text is organized, structured, and sequenced (continued)</p> <p data-bbox="103 407 318 438">2.5.2 <i>Text Forms</i></p> <ul data-bbox="175 464 521 667" style="list-style-type: none">❖ recognize and use a variety of simple text forms in guided situations (e.g., menus, advertisements, sports broadcasts) <p data-bbox="103 1087 526 1119">2.5.3 <i>Patterns of Social Interaction</i></p> <ul data-bbox="175 1144 540 1348" style="list-style-type: none">❖ initiate interactions, and respond using simple social interaction patterns (e.g., request-acceptance/nonacceptance)	<p data-bbox="605 464 1419 705">➤ Provide students with a friendly letter that has been divided into different sections. Students reorganize the sections into an appropriate sequence. Discuss the usual parts of a friendly letter and standard terms. Using the letter provided by the teacher as a model, students prepare a letter that they can send to another member of the class or to a penpal in a Spanish-speaking country.</p> <p data-bbox="605 1144 1419 1209">➤ Have students work in pairs in order to email each other a simple message in Spanish.</p> <p data-bbox="605 1577 1419 1713">➤ Provide students with a simple telephone conversation that is not in the correct order (e.g., getting together with a friend, ordering a pizza, leaving a message, etc.). In pairs, students reorganize the conversation into the correct order.</p> <p data-bbox="654 1734 1419 1799">As an extension, students can prepare their own telephone conversation in pairs and present them to the class.</p>



SUGGESTIONS FOR ASSESSMENT

SUGGESTED LEARNING RESOURCES

- Work with students to develop a simple checklist they can use for self and peer assessment of their letter or email. The checklist might include items such as the following:

- meaning is clear
- interesting details are included
- questions are appropriate
- greeting and closing are appropriate
- sentence frames are written correctly and completed appropriately
- punctuation is appropriate (language competence, attend to form)
- spelling, including accents, is correct (language competence, attend to form) (*BC Resource Package*, 37)

(See examples of checklist criteria in Classroom Assessment, p. 12.)

- When students prepare telephone conversations, discuss criteria with students before they begin. Assessment criteria should focus on the extent to which students are able to

- make plans for an activity responding to the following questions: Where? When? Why? How? What? (*¿Dónde?, ¿Cuándo?, ¿Por qué?, ¿Cómo?, ¿Qué?*)
- present clear, complete, and appropriate messages
- use vocabulary and expressions appropriately

- Assessment criteria for the response might include the following:

- a clear response is given
- sentence structure is accurate (language competence, attend to form)
- vocabulary and structures required to arrange meeting times and places are used correctly (language competence, attend to form)

¡Dime! Uno

Unidad 2, Lección 3

¡Buen Viaje! 1A

p. 37

¡Buen Viaje! 1B

pp. 240–283

¡Dime! Uno

Unidad 3, Lección 2

¡Buen Viaje! 1B

p. 302



Notes

*GLOBAL
CITIZENSHIP
YEAR 2*

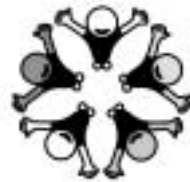

Global Citizenship



study historical and contemporary elements of Spanish-speaking cultures

affirm diversity

Students will acquire the knowledge, skills, and attitudes to be effective global citizens, through the exploration of the cultures of the Spanish-speaking world.

explore personal and career opportunities



GLOBAL CITIZENSHIP

General Outcome 3: Students will acquire the knowledge, skills, and attitudes to be effective global citizens, through the exploration of the cultures of the Spanish-speaking world.

The outcomes for Global Citizenship deal with a broad range of knowledge, skills, and attitudes needed to be effective global citizens—in other words, with the development of intercultural competence. The concept of global citizenship encompasses citizenship at all levels, from the local school and community to Canada and the world.

The various components of global citizenship are grouped under three cluster headings—see the illustration on the preceding page. Under each of these headings there are several strands. Each strand deals with a single aspect of intercultural competence. For example, under the cluster heading **study historical and contemporary elements of Spanish-speaking cultures**, there are strands for the processes and methods of acquiring knowledge about Spanish-speaking cultures, the cultural knowledge thus acquired, applications of that knowledge to aid comprehension and to communicate in appropriate ways, positive attitudes toward Spanish-speaking cultures, as well as knowledge of the diversity within those cultures.

Developing cultural knowledge and skills is a lifelong process. Knowledge of one's own culture is acquired over a lifetime. Cultures change over time. Within any national group, there may be a dominant culture or cultures and a number of minority cultures. Rather than try to develop an extensive bank of knowledge about the Spanish-speaking cultures, it is more important for students to learn the processes and methods of accessing and analyzing cultural practices. Students will gain cultural knowledge in the process of developing these skills. In this way, if they encounter elements of the Spanish-speaking cultures they have not learned about in class, they will have the skills and abilities to deal with them effectively and appropriately.

The **affirm diversity** heading covers knowledge, skills, and attitudes that are developed as a result of bringing other languages and cultures into relationship with one's own. There is a natural tendency, when learning a new language and culture, to compare it with what is familiar. Many students leave a second language learning experience with a heightened awareness and knowledge of their own language and culture. They will also be able to make some generalizations about languages and cultures based on their experiences and those of their classmates who may have a variety of cultural backgrounds. This will provide students with an understanding of diversity within both a global and a Canadian context.



PRESCRIBED OUTCOMES	SUGGESTIONS FOR INSTRUCTION
<p>General Outcome 3: Global Citizenship</p> <p>Students will acquire the knowledge, skills, and attitudes to be effective global citizens through the exploration of the cultures of the Spanish-speaking world.</p> <p>3.1 study historical and contemporary elements of Spanish-speaking cultures</p> <p>3.1.1 <i>Access/Analyze Cultural Knowledge</i></p> <ul style="list-style-type: none">❖ make observations of Spanish-speaking cultures (e.g., as it is portrayed in texts and in the community)❖ seek out information about Spanish-speaking cultures from authentic sources (e.g., people)	<ul style="list-style-type: none">➤ Show students a video or video-clip that takes place in Spanish-speaking country and represents both traditional and contemporary cultures. Afterwards, provide students with specific questions to discuss what they observed in the video (<i>BC Resource Package, 34</i>). ➤ Provide students with a variety of art, music, and artifacts from Spanish-speaking countries. Have students prepare their own representation of what they heard and saw. This could be in the form of a collage, CD cover, poster, etc.

(continued)



SUGGESTIONS FOR ASSESSMENT

SUGGESTED LEARNING RESOURCES

- When students discuss a video that features traditional and contemporary Spanish-speaking cultures, look for evidence that they
 - identify contemporary and traditional characteristics
 - notice similarities and differences from other cultures
 - ask questions that prompt new learning or information
 (BC *Resource Package*, 35)

¡Buen Viaje! 1
La Catrina

- When students create a collage, CD cover, or poster to represent what they heard or saw in a variety of art, music, or artifacts, look for evidence that they are able to offer unique personal perspectives or impressions by combining visual elements with words.

¡Buen Viaje! 1
Lecturas culturales y
Lecturas opcionales
Introduction to each Chapter



PRESCRIBED OUTCOMES	SUGGESTIONS FOR INSTRUCTION
<p>3.1 study historical and contemporary elements of Spanish-speaking cultures (continued)</p> <p>3.1.2 <i>Knowledge of Spanish-Speaking Cultures</i></p> <ul style="list-style-type: none">❖ participate in activities and experiences that reflect elements of Spanish-speaking cultures <p>3.1.3 <i>Apply Cultural Knowledge</i></p> <ul style="list-style-type: none">❖ identify elements of Spanish-speaking cultures in the school and community	<ul style="list-style-type: none">➤ Invite students to research the Aztecs, Incas, or Mayas. Ask them to create charts comparing various aspects of these civilizations, for example, food, celebrations, rituals, architecture, music, art, leisure activities (BC <i>Resource Package</i>, 26). ➤ Have students research the geography of a Spanish-speaking country and prepare a map that indicates: major cities and climate. Have students relate at least one element of the culture that they are familiar with to the geography of the country (e.g., relate the foods typically eaten with the geography and climate—coastal areas of Spain eat more seafood). ➤ Using videos, the Internet, and magazines, have students identify ways in which Spanish-speaking people of their own age are similar and different.



SUGGESTIONS FOR ASSESSMENT

SUGGESTED LEARNING RESOURCES

- When students research and represent aspects of indigenous civilizations of Mexico and Central and South America, look for evidence that they
 - make comparisons between the various cultures
 - ask questions that lead to new information or insights
 - show initiative and interest in seeking information from a variety of print, human, and electronic sources
 - provide accurate information
 - avoid stereotyping or prejudging

(*BC Resource Package, 27*)

Provide students with lists of questions which they must answer based on the information charts prepared by different groups.

- When students research the geography of a Spanish-speaking country, look for evidence that they are able to
 - make a link between geography and culture
 - label maps with appropriate information

- As students examine videos, the Internet, and magazines, look for evidence that they are able to identify similarities and differences between themselves and Spanish-speaking people of their own age.

¡Buen Viaje! 1B
pp. 398, 399, 422, 423,
307–309, 436–439

Chicos Chicas, Nivel 1
Unidad 2, pp. 34–35

Imágenes de América Latina
Capítulo 3

Planet@ 1 and 2
Sección: 350 millones

¡Buen Viaje! 1A
Capítulo 9

¡Buen Viaje! 1B
Capítulo 11

¡Buen Viaje! 1A, 1B
Lecturas culturales y
Lecturas opcionales

Imágenes de América Latina
Capítulo 3



PRESCRIBED OUTCOMES	SUGGESTIONS FOR INSTRUCTION
<p>3.1 study historical and contemporary elements of Spanish-speaking cultures (continued)</p> <p>3.1.4 <i>Diversity of Spanish-Speaking Cultures</i></p> <ul style="list-style-type: none">❖ identify some elements that reflect diversity within Spanish-speaking cultures <p>3.1.5 <i>Value Spanish-Speaking Cultures</i></p> <ul style="list-style-type: none">❖ participate in cultural activities and experiences	<ul style="list-style-type: none">➤ When comparing the Aztecs, Incas, and Mayas, explore the relationships of these indigenous peoples with the peoples of Spanish ancestry in Central and South America. How does this compare with the relationship of Canada's indigenous peoples and those of European origin?➤ Using videos, the Internet, and magazines, have students identify ways in which Spanish-speaking people of their own age are similar and different.➤ Have students adopt a foster child from a Spanish-speaking country. When letters are received, read them to the class and have students reply with a Spanish letter from the class.
<p>3.2 affirm diversity</p> <p>3.2.1 <i>Awareness of First Language</i></p> <ul style="list-style-type: none">❖ identify similarities and differences between their first language and Spanish (e.g., different social conventions, cognates)	<ul style="list-style-type: none">➤ Provide students with a list of words that includes both English and Spanish words. Students match the English word with its Spanish cognate. (e.g., <i>invitación</i>—invitation). <p>Have students explain the similarities and differences between the English and Spanish words.</p>

(continued)



SUGGESTIONS FOR ASSESSMENT

SUGGESTED LEARNING RESOURCES

- When students compare the relationships of indigenous peoples with those of Spanish ancestry, look for evidence that they are able to identify differences in ethnic backgrounds.

- As students examine videos, the Internet, and magazines, look for evidence that they are able to identify similarities and differences between themselves and Spanish-speaking people of their own age.

- When students match English words with its Spanish cognate, look for evidence that they are able to
 - match the words correctly
 - give some similarities between English and Spanish
 - give some differences between English and Spanish

Provide students with a text that has some common errors made with cognates and have students correct the text.

¡Dime! Uno
 Lección preliminar
 Unidad 1, Lección 3

¡Buen Viaje! 1A
 Capítulo 2, p. 62

Chicos Chicas, Nivel 1
 Glosario

Planet@ 1
 Glosario



PRESCRIBED OUTCOMES	SUGGESTIONS FOR INSTRUCTION									
<p>3.2 affirm diversity (continued)</p> <p>3.2.2 <i>General Language Knowledge</i></p> <ul style="list-style-type: none">❖ recognize that, within any linguistic group, individuals use language in personal ways❖ recognize that in any language there are different words for the same thing <p>3.2.3 <i>Awareness of Own Culture</i></p> <ul style="list-style-type: none">❖ recognize similarities between their own culture and other cultures (e.g., celebrations, foods, roles of family members)❖ make connections between individuals or situations in texts and their own personal experiences	<p>➤ As students study various themes, provide them with expressions/vocabulary from a variety of Spanish-speaking countries.</p> <p>➤ Provide students with some examples of a variety of words for the same item. Discuss. Examples include the following:</p> <table data-bbox="698 630 1234 735"><tr><td><i>coche</i></td><td><i>voiture</i></td><td>vehicle</td></tr><tr><td><i>auto</i></td><td><i>auto</i></td><td>automobile</td></tr><tr><td><i>carro</i></td><td></td><td>car</td></tr></table> <p>➤ As a class, brainstorm typical Canadian sports. Then suggest that students read magazines and watch videos or television programs about sports typical of the Spanish-speaking world, especially baseball and soccer. Ask students to discuss the importance of these sports in Spanish-speaking regions. Invite them to play some of these sports or role-play a sports-related event (e.g., awards night, sports commentary) (BC <i>Resource Package</i>, 34).</p> <p>➤ Have students generate questions they can use to interview Spanish-speaking people in the community about similarities between their own and the respondent's cultures. Ask each student to collect the information and display it on a chart (BC <i>Resource Package</i>, 34).</p> <p style="text-align: right;"><i>(continued)</i></p>	<i>coche</i>	<i>voiture</i>	vehicle	<i>auto</i>	<i>auto</i>	automobile	<i>carro</i>		car
<i>coche</i>	<i>voiture</i>	vehicle								
<i>auto</i>	<i>auto</i>	automobile								
<i>carro</i>		car								



SUGGESTIONS FOR ASSESSMENT

- Look for evidence that students are able to recognize a variety of words for the same item. Provide students with a list of words which can be divided into categories with some word meanings.

- When students examine common sports and typical sports in the Spanish-speaking world, look for evidence that students are able to
 - recognize similarities and differences
 - identify common activities and behaviour associated with specific sporting events
 - use appropriate vocabulary associated with specific sports (language competence, attend to form)

- When students prepare information charts of similarities and differences between their culture and the culture of a Spanish-speaking person in the community, look for evidence that
 - similarities and differences are clearly identified
 - chart is well organized and has an appropriate layout
 - chart is neat and easy to read
 - appropriate vocabulary is used and spelled correctly (language competence, attend to form)

SUGGESTED LEARNING RESOURCES

¡Dime! Uno
Unidad 7

¡En español! 1
Unidad 3, Etapa 2
Cultura y comparaciones



SUGGESTIONS FOR ASSESSMENT

- When students compare typical family menus for a festive occasion in a Spanish-speaking country with a festive menu in their own family, look for evidence that they
 - identify similarities and differences, using appropriate vocabulary
 - respect diversity and differences in cultures

- When students participate in cultural activities, look for evidence that they
 - are attentive when a new activity is being introduced
 - understand the activity
 - participate willingly
 - comment on how the activities are the same or different from activities in other cultures
 - use vocabulary related to the activities (language competence, attend to form)

Photograph students while they are engaged in activities. This provides a tool to observe students' participation and provides an excellent means to review/discuss activities at a later date.

- Look for evidence that students are able to make connections between the country's culture, geography, and climate.

SUGGESTED LEARNING RESOURCES

¡Buen Viaje! 1A
Capítulo 7

¡Buen Viaje! 1B
Capítulo 14

¡Buen Viaje!
Videos

¡Dime! Uno
Unidad 4, Lección 1
Video

¡Viva el Español!: ¡Hola!
Resource and Activity Book

¡Viva el Español!: ¿Qué tal?
Resource and Activity Book

¡Viva el Español!: ¡Adelante!
Resource and Activity Book
Culture Resource Book



PRESCRIBED OUTCOMES	SUGGESTIONS FOR INSTRUCTION
<p>3.2 affirm diversity (continued)</p> <p>3.2.5 <i>Value Diversity</i></p> <ul style="list-style-type: none">❖ engage in activities that reflect other ways of doing things or other perspectives <p>3.2.6 <i>Intercultural Skills</i></p> <ul style="list-style-type: none">❖ listen with attention to the opinions of others❖ initiate and maintain new relationships (e.g., make a new classmate feel welcome)	<ul style="list-style-type: none">➤ Have students participate in a variety of cultural activities throughout the course, including trying new foods, listening to music that is different from what they usually hear, etc.➤ When doing activities on the qualities of a good friend, have the students reflect on their own behaviour towards their friends in their personal journal. Can they remember occasions when they had a positive or negative effect on a friend by something they did or said?
<p>3.3 personal and career opportunities</p> <p>3.3.1 <i>Spanish Language and Spanish-Speaking Cultures</i></p> <ul style="list-style-type: none">❖ suggest some reasons for learning Spanish❖ identify some personal uses they have made of their knowledge of Spanish and Spanish-speaking cultures <p>3.3.2 <i>Cultural and Linguistic Diversity</i></p> <ul style="list-style-type: none">❖ suggest some reasons for participating in activities and experiences that reflect elements of different cultures❖ identify some personal uses they have made of their knowledge of different languages and cultures	<ul style="list-style-type: none">➤ Generate, with the students, a list of the "Top Ten Reasons" ("<i>Las 10 mejores razones para aprender el español</i>") for learning Spanish.➤ Invite students to share an experience where they had to call on their Spanish language knowledge or skills.➤ Conduct an interview with students at the end of the semester in which students respond to the following questions: Why are you learning Spanish? Where do you see yourself using Spanish in the future?



SUGGESTIONS FOR ASSESSMENT	SUGGESTED LEARNING RESOURCES
<ul style="list-style-type: none"> ➤ Look for evidence that students demonstrate a willingness to participate in a typically Latin-American cultural situation. ➤ Look for evidence that students are able to identify ways in which their actions impact upon others. 	<p><i>¡Viva el Español!: ¡Hola! Resource and Activity Book</i></p> <p><i>¡Viva el Español!: ¿Qué tal? Resource and Activity Book</i></p> <p><i>¡Viva el Español!: ¡Adelante! Resource and Activity Book Culture Resource Book</i></p>
<ul style="list-style-type: none"> ➤ As students generate a list of reasons for studying Spanish, look for evidence that they <ul style="list-style-type: none"> • provide thoughtful suggestions • participate in the activity • understand some important reasons for studying another language such as Spanish 	
<ul style="list-style-type: none"> ➤ When students respond to questions about their reasons for learning Spanish and their future with Spanish, look for evidence that they <ul style="list-style-type: none"> • give thoughtful responses • are able to explain their reasons and responses adequately, with relevant detail 	



Notes

STRATEGIES
YEAR 2





Strategies

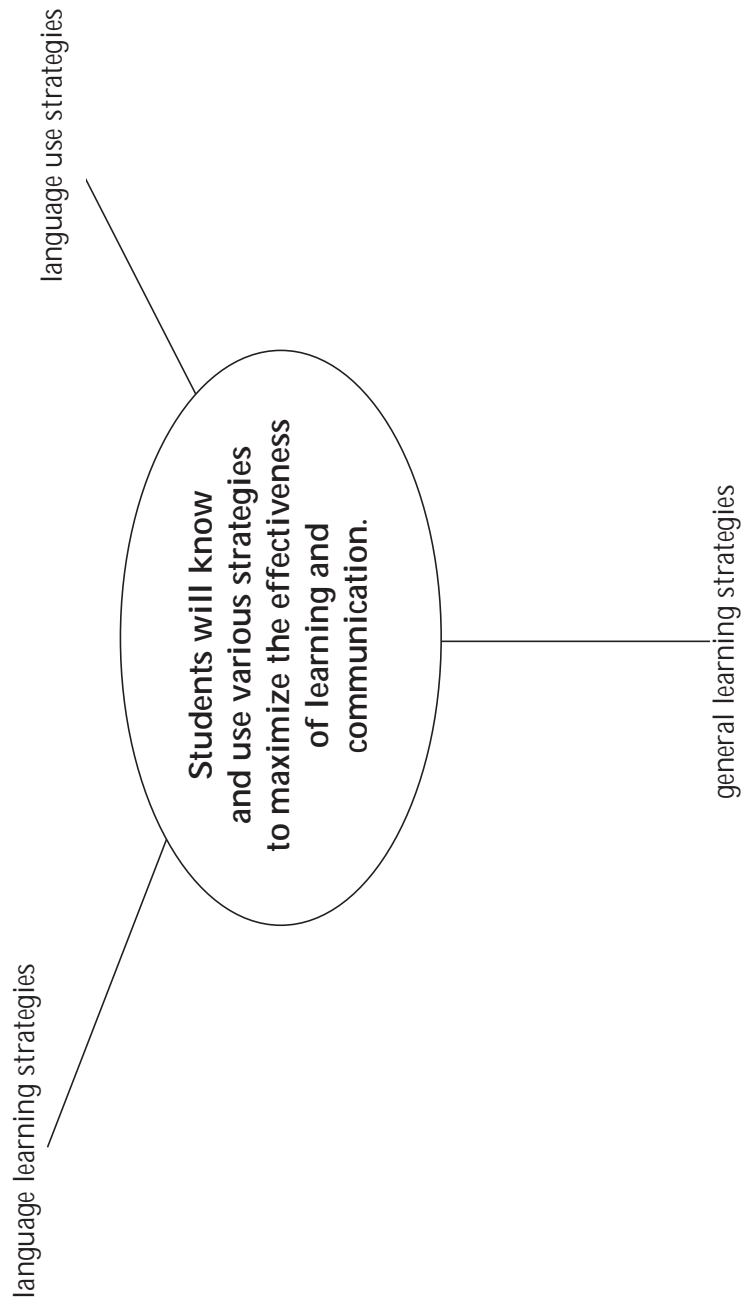



STRATEGIES

General Outcome 4: Students will know and use various strategies to maximize the effectiveness of learning and communication.

Under the Strategies heading are specific outcomes that will help students learn and communicate more effectively. Strategic competence has long been recognized as an important component of communicative competence. The outcomes that follow deal not only with compensation and repair strategies, important in the early stages of language learning when proficiency is low, but also with strategies for language learning, language use in a broad sense, as well as general learning strategies that help students acquire content. Although people may use strategies unconsciously, the outcomes deal only with the conscious use of strategies.

The strategies are grouped under three cluster headings—see the illustration on the preceding page. Under each of these headings there are several strands. Each strand deals with a specific category of strategy. Language learning and general learning strategies are categorized as cognitive, metacognitive, and social/affective. The language use strategies are organized by communicative mode: interactive, interpretive, and productive.

The strategies that students choose depend on the task they are engaged in as well as on other factors, such as their preferred learning style, personality, age, attitude, and cultural background. Strategies that work well for one person may not be effective for another person or may not be suitable in a different situation. For this reason it is not particularly useful to say that students should be aware of, or able to use, a specific strategy in a particular course. Consequently, the specific outcomes describe the students' knowledge of and ability to use general types of strategies. More specific strategies for each general category or type are included in the comprehensive list of strategies in Appendix E. The specific strategies provided in the comprehensive list are not prescriptive but are provided as an illustration of how the general strategies in the specific outcomes might be developed.

Teachers need to know and be able to demonstrate a broad range of strategies from which students are then able to choose in order to communicate effectively. Strategies of all kinds are best taught in the context of learning activities where students can apply them immediately and then reflect on their use.



PRESCRIBED OUTCOMES	SUGGESTIONS FOR INSTRUCTION						
<p>4.1 language learning strategies (continued)</p> <p>4.1.2 <i>Metacognitive</i></p> <ul style="list-style-type: none">❖ use a variety of simple metacognitive strategies, with guidance, to enhance language learning (e.g., rehearse or role-play language) <p>4.1.3 <i>Social/Affective</i></p> <ul style="list-style-type: none">❖ use a variety of simple social and affective strategies, with guidance, to enhance language learning (e.g., reread familiar self-chosen texts to enhance understanding and enjoyment)	<p>➤ Provide students with a plan to help them write a friendly letter. The plan could include the following:</p> <table><tr><td><i>Descripción física y personalidad</i></td><td><i>Mi Familia</i></td></tr><tr><td><i>Yo</i></td><td><i>Mis amigos</i></td></tr><tr><td><i>Voy a</i></td><td><i>Tengo que</i></td></tr></table> <p>➤ Encourage students to reflect on their learning style by generating a list of questions related to a previous activity. Questions might include the following:</p> <ul style="list-style-type: none">• What part of the activity did you find the most useful?• What strategies did you use to be successful in this activity?• What might have improved your language learning?• What aspects of your group work worked well? How could you change or improve your contribution to the group in further activities?• What can you learn from the mistakes you made during the activity?	<i>Descripción física y personalidad</i>	<i>Mi Familia</i>	<i>Yo</i>	<i>Mis amigos</i>	<i>Voy a</i>	<i>Tengo que</i>
<i>Descripción física y personalidad</i>	<i>Mi Familia</i>						
<i>Yo</i>	<i>Mis amigos</i>						
<i>Voy a</i>	<i>Tengo que</i>						



SUGGESTIONS FOR ASSESSMENT

- When students use a plan to help them write a friendly letter, look for evidence that
 - students used the plan to write the letter
 - students understood the value of making a plan in advance
 - each of the categories has relevant ideas and details
 - appropriate vocabulary and expressions are used

- When students respond to reflection questions in a learning log, look for evidence that they are
 - attempting to respond with clear ideas and relevant details
 - seeking to understand their individual learning
 - seeking to identify strategies that will help improve their individual learning

SUGGESTED LEARNING RESOURCES

¡Dime! Uno
Unidad 2, Lección 3

¡Buen Viaje! 1A
Capítulo 1, 6



PRESCRIBED OUTCOMES	SUGGESTIONS FOR INSTRUCTION
<p>4.2 language use strategies</p> <p>4.2.1 <i>Interactive</i></p> <ul style="list-style-type: none">❖ use a variety of simple interactive strategies, with guidance (e.g., ask for clarification or repetition when they do not understand) <p>4.2.2 <i>Interpretive</i></p> <ul style="list-style-type: none">❖ use a variety of simple interpretive strategies, with guidance (e.g., determine the purpose of listening, listen or look for key words) <p>4.2.3 <i>Productive</i></p> <ul style="list-style-type: none">❖ use a variety of simple productive strategies, with guidance (e.g., use illustrations to provide detail when producing their own texts)	<p>➤ Brainstorm with students ways in which they can maintain interaction in a conversation. Teach students some strategies to maintain interaction. Organize students into teams. Provide a scenario (e.g., at the shopping mall, at a restaurant, at home with the family, etc.).</p> <p>One team begins a conversation, based on the scenario that has been set. As many students as possible from the team should provide a line for the conversation in 30 to 60 seconds.</p> <p>Each student builds on the line provided by the preceding student.</p> <p>At the end of the allotted time, clap hands or ring a bell and provide another scene for the next team.</p> <p>➤ Have students listen to a song and note repeated words or phrases. Students determine what the message of the song is, based on the repeated words or phrases.</p> <p>➤ Provide students with strategies and behaviours that help promote active listening. For example, have students think about what they might hear in a text, listen for key words, or consider body language.</p> <p>➤ As students prepare a storybook, encourage them to use illustrations to provide detail they are not able to express verbally.</p>



SUGGESTIONS FOR ASSESSMENT

SUGGESTED LEARNING RESOURCES

- When students participate in spontaneous interactions such as group improvisation activities, look for evidence that they are able to
 - sustain the interactions using a variety of strategies (e.g., body language, repeating)
 - speak clearly and make themselves understood (language competence, attend to form)
 - use appropriate vocabulary (language competence, attend to form)
 - respond appropriately to questions and cues from others (applications)

- Have students demonstrate their understanding of the theme of a song by illustrating or creating a collage to represent the theme. Repeated phrases or words should be included as a part of the illustration/collage.

To verify understanding of key words or phrases, create a cloze activity that verifies the correct use of these important words or phrases.

- Create an observation checklist in order to verify the extent to which students have made an attempt to use a range of strategies and behaviours to help promote active listening.

- When students prepare illustrations for a storybook, look for evidence that
 - main ideas are clearly represented
 - details are clearly represented

¡Viva el Español!: ¡Hola!
Resource and Activity Book
Song Cassette (Music and Lyrics)

¡Viva el Español!: ¿Qué tal?
Resource and Activity Book
Song Cassette (Music and Lyrics)

¡Viva el Español!: ¡Adelante!
Resource and Activity Book
Song Cassette (Music and Lyrics)



PRESCRIBED OUTCOMES	SUGGESTIONS FOR INSTRUCTION
<p>4.3 general learning strategies</p> <p>4.3.1 <i>Cognitive</i></p> <ul style="list-style-type: none">❖ use simple cognitive strategies to enhance general learning (e.g., experiment with and concentrate on one thing at a time) <p>4.3.2 <i>Metacognitive</i></p> <ul style="list-style-type: none">❖ use simple metacognitive strategies to enhance general learning (e.g., decide in advance to attend to the learning task) <p>4.3.3 <i>Social/Affective</i></p> <ul style="list-style-type: none">❖ use simple social and affective strategies to enhance general learning (e.g., participate in cooperative group learning tasks)	<p>➤ When using audiovisual resources, show the resource with no sound the first time. Ask students to concentrate on what they see and to talk about one image that is dominant for them. After the activity, talk about how they remember things. Do they see a picture in their mind (visual), hear words or sounds (auditory), or feel physical sensations or movement (kinesthetic)?</p> <p>➤ When introducing a research project (e.g., Mayas, Incas, Aztecs), have students brainstorm about where they might find information. Provide students with a plan to help them organize their research and how they will divide the work. After the project, ask students to reflect on how effective their planning was.</p> <p>(See Ideas for Exhibitions and Projects in Classroom Assessment, pp. 24–25.)</p> <p>➤ When students are exploring artifacts from Spanish-speaking countries, encourage them to choose an artifact in which they are particularly interested and to use a form of representation in which they enjoy working. Provide students with the opportunity to propose other options if they have a particular interest.</p>



SUGGESTIONS FOR ASSESSMENT

- Look for evidence that students are able to
 - identify a variety of strategies to enhance general learning
 - identify one or two strategies that are particularly effective for them

- When students prepare a research project using a plan, look for evidence that they
 - make a plan
 - use a plan
 - see the value in a plan

- When students represent an artifact in a form of their choice, look for evidence that they are able to
 - choose an activity/form
 - represent the artifact effectively with the form chosen

SUGGESTED LEARNING RESOURCES

Imágenes de América Latina
Capítulo 3



Notes

YEAR 3

Applications	3
Language Competence	21
Global Citizenship	49
Strategies	67
Appendices	81

APPLICATIONS
YEAR 3



Applications

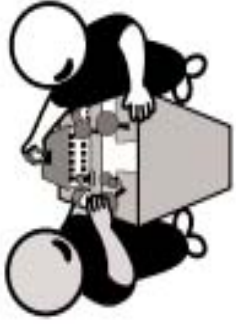

express emotions and personal perspectives

impart and receive information

get things done

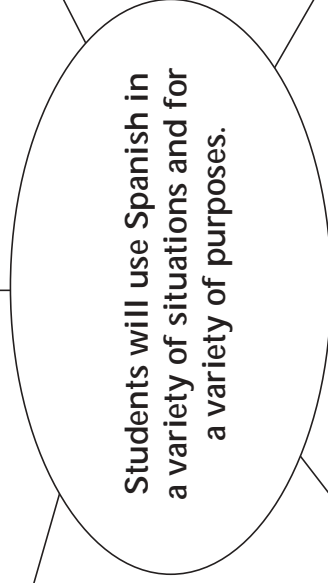

use the language for imaginative purposes and personal enjoyment

form, maintain, and change interpersonal relationships

extend their knowledge of the world



APPLICATIONS

General Outcome 1: Students will use Spanish in a variety of situations and for a variety of purposes.

The specific outcomes under the heading Applications deal with **what** the students will be able to do with the Spanish language, that is, the **functions** they will be able to perform and the **contexts** in which they will be able to operate. This functional competence, also called actional competence, is important for a content-based or task-based approach to language learning where students are constantly engaged in meaningful tasks (Celce-Murcia, Dörnyei, and Thurrell).

The functions are grouped under six cluster headings—see the illustration on the preceding page. Under each of these headings, there are one or more strands. Each strand deals with a specific language function (e.g., share factual information). Students at any grade level will be able to share factual information. Beginning learners will do this in very simple ways (e.g., “This is my dog.”). As students gain more knowledge and experience, they will broaden the range of subjects they can deal with, they will learn to share information in writing as well as orally, and they will be able to handle formal and informal situations.

Different models of communicative competence have organized language functions in a variety of ways. The organizational structure chosen here reflects the needs and interests of students in a classroom where activities are focused on meaning and are interactive. For example, the strand entitled **manage group actions** has been included to ensure that students acquire the language necessary to function independently in small groups, since this is an effective way of organizing second language classrooms. The strands under the cluster heading **to extend their knowledge of the world** will accommodate a content-based approach to language learning where students learn content from another subject area as they learn the Spanish language.

The level of linguistic, sociolinguistic, and discourse competence that students will exhibit when carrying out the functions is defined in the specific outcomes for Language Competence for each course. To know how well students will be able to perform the specific function, the Applications outcomes must be read in conjunction with the Language Competence outcomes.



PRESCRIBED OUTCOMES	SUGGESTIONS FOR INSTRUCTION
<p>General Outcome 1: Applications Students will use Spanish in a variety of situations and for a variety of purposes.</p> <p>1.1 impart and receive information</p> <p>1.1.1 <i>Share Factual Information</i></p> <ul style="list-style-type: none">❖ ask for and provide information on a range of familiar topics❖ describe people, places, things, and series or sequences of events or actions	<ul style="list-style-type: none">➤ Invite students to use a variety of sources (e.g., books, magazines, brochures, CD-ROM encyclopedia, Internet) to research travel in a Spanish-speaking country. Ask students to each collect and present ten helpful hints for travelling in that country. Possible topics might include: Things to see, Places to eat, or Where to stay. As an extension, the class could compile a master list of tips for travel in Spanish-speaking countries (BC <i>Resource Package</i>, 70).➤ Have each student choose a Spanish-speaking country or region of personal interest. Then ask students to form groups according to the regions they chose and research them, using a variety of sources (e.g., tourist brochures, magazine and newspaper articles, the Internet, etc.). Have groups develop oral, written, and visual presentations promoting their regions as tourist destinations. Ask groups to present their work at a class Travel Fair. As an extension, have each student select a new travel destination based on the presentations and record reasons for the choice (BC <i>Resource Package</i>, 70).➤ Have students prepare a skit—"A trip to the doctor's office"—using expressions with "<i>tener</i>" (<i>los estados físicos</i>).



SUGGESTIONS FOR ASSESSMENT

SUGGESTED LEARNING RESOURCES

- When students work on a research project look, for evidence that they present accurate and detailed information.

Planet@ 1
Tema 2, pp. 50–53

Internet

Chicos Chicas, Nivel 1
Unidad 8, Lección 15

- Work with students to develop criteria for their Travel Fair. Criteria might include the following:
 - provides information on at least three topics
 - includes accurate, relevant, and detailed information
 - uses clear and appropriate language (language competence, attend to form)
 - is logically organized (language competence)
 - takes risks to add interest and offer complex information (strategies)

Internet

¡Buen Viaje! 3
Capítulo 1 y
Capítulo 1 Video Activities
Machu Picchu

Planet@ 2
Tema 3

Chicos Chicas, Nivel 1
Al final de cada unidad

- Discuss criteria with students before they role-play “A Trip to the Doctor’s Office.” Criteria might include the following:
 - meaning is clear
 - appropriate details are included in questions and answers
 - vocabulary and expressions related to the topic are included (language competence, attend to form)
 - gestures and body language support communication (strategies)
 - pronunciation and intonation are generally accurate (language competence, attend to form)
 - interaction has some sense of fluency and spontaneity (language competence, interactive fluency)
 (See role-play criteria in Classroom Assessment, p. 11.)

¡En español! 2
Unidad 3, Etapa 3
No subjuntivo

¡Dime! Más
Unidad 7, Lección 2

¡Buen Viaje! 2
Capítulo 8 y Video Episode 8
Una emergencia médica

¡Buen Viaje! 3
Capítulo 7
pp. 301–306



PRESCRIBED OUTCOMES	SUGGESTIONS FOR INSTRUCTION
<p>1.2 express emotions and personal perspectives</p> <p>1.2.1 <i>Share Ideas, Thoughts, Opinions, Preferences</i></p> <ul style="list-style-type: none">❖ inquire about and express likes and dislikes (e.g., <i>prefiero leche</i>)❖ record and share thoughts and ideas with others (e.g., keep a journal of ideas for stories) <p>1.2.2 <i>Share Emotions, Feelings</i></p> <ul style="list-style-type: none">❖ inquire about and express emotions and feelings (e.g., <i>no me siento bien</i>)❖ record and share personal experiences involving an emotion or feeling (e.g., happiness, anger, embarrassment)	<p>➤ Present students with a variety of pictures depicting activities that can be done when travelling. Ask students which activities they prefer, using questions such as <i>¿Prefieres _____ o _____ ? ¿Qué prefieres hacer _____ o _____ ?</i></p> <p>➤ Have students prepare surveys related to a theme studied (e.g., favourite entertainment figures, favourite types of music, hobbies, etc.).</p> <p>➤ Have students do a survey to find a person with whom they would be suited to go on a trip, based on preferred activities in common. The survey could use simple questions such as <i>¿Te gusta _____ ? Prefieres _____ o _____ ?</i></p> <p>➤ Have students view a video of a medical emergency. Have students identify and respond to the emotions expressed. Ask students how they felt during and after watching the video.</p>



SUGGESTIONS FOR ASSESSMENT

SUGGESTED LEARNING RESOURCES

- When students respond to pictures/surveys by stating their preferences, look for evidence that students
 - are able to provide reasons for their preferences
 - use the correct forms of "*preferir*" (language competence, attend to form)
 - use appropriate vocabulary to describe activities (language competence, attend to form)

- When students survey classmates in order to find someone with whom they would be suited to go on a trip, observe that students
 - speak in Spanish throughout activity
 - speak to several classmates
 - identify a classmate with whom they could travel by identifying common preferred activities

¡En español! 2
Unidad 1, Etapa 1

¡Dime! Más
Unidad 6, Lección 1, 2

Planet@ 1
Tema 3, pp. 67–82

Chicos Chicas, Nivel 1
Unidad 7, Lección 14

¡Buen Viaje! 3
Capítulo 1

Planet@ 1
Tema 3, pp. 67–82

Chicos Chicas, Nivel 1
Unidad 7, Lección 14 y
Al final de cada unidad



PRESCRIBED OUTCOMES	SUGGESTIONS FOR INSTRUCTION
<p>1.3 get things done</p> <p>1.3.1 <i>Guide Actions of Others</i></p> <ul style="list-style-type: none">❖ relay simple messages❖ encourage or discourage others from a course of action❖ give and follow a simple sequence of instructions <p>1.3.2 <i>State Personal Actions</i></p> <ul style="list-style-type: none">❖ make an offer or an invitation, and respond to offers and invitations made by others❖ inquire about and express ability and inability to do something (e.g., <i>hablo español</i>)	<p>➤ Have students participate in a simple game such as “<i>Simón dice</i>,” “<i>Pato Pato</i>,” “<i>Ganso</i>,” or “<i>Teléfono</i>.” Then ask students to lead one of these games or teach an alternative game of their choice to the class.</p> <p>➤ Pair students and have them role-play a parent and a son or daughter who is going out on a first date. The parent should put forward advice encouraging certain behaviours and discouraging others. Emphasize date safety.</p> <p>➤ Brainstorm with students about the type of activities that they like to do on the weekend. Discuss with students the kind of questions/expressions they need in order to plan weekend activities with a friend. Provide students with an information gap activity with two different schedules and some common activities to organize (e.g., <i>¿Puedes ir al cine a las tres de la tarde? No, no puedo. Tengo que ir a la clase de piano. ¿Y a las siete de la noche? Sí, si puedo.</i>)</p> <p>Then have students organize their own weekend activities in pairs, using the key questions and expressions provided in the model dialogue.</p>



SUGGESTIONS FOR ASSESSMENT

SUGGESTED LEARNING RESOURCES

- When students present and participate in games, look for evidence that they
 - are prepared, with clear instructions
 - are able to respond to classmates' questions
 - encourage participation in the game and participate willingly themselves

- When students role-play, look for evidence that they are increasingly able to
 - make themselves understood in Spanish
 - use learned patterns and vocabulary (language competence, attend to form)
 - take risks to add details or unfamiliar language
 - use strategies such as non-verbal communication and visual props to support their messages (strategies)
 - be accurate

(See role-play assessment criteria in Classroom Assessment, p. 11.)

- While students organize weekend activities in pairs, look for evidence that they
 - invite (*querer, poder*)
 - accept, including key details about time and activities
 - decline, giving reasons (*tener que*)
 - use a logical sequence of events

¡Buen Viaje! 2
 Capítulo 5
 Vocabulario

¡Díme! Algo
 Unidad 3, Lección 3

¡Buen Viaje! 3
 Capítulo 3
 pp.103–121

Planet@ 1
 Tema 4

Chicos Chicas, Nivel 1
 Unidad 3, Lección 5



PRESCRIBED OUTCOMES	SUGGESTIONS FOR INSTRUCTION
<p>1.3 get things done (continued)</p> <p>1.3.3 <i>Manage Group Actions</i></p> <ul style="list-style-type: none">❖ encourage other group members to participate❖ assume a variety of roles and responsibilities as group members❖ negotiate in a simple way with peers in small-group tasks❖ offer to explain or clarify	<ul style="list-style-type: none">➤ When students are preparing a project in groups such as the Travel Fair (see page Year 3 – 4), assign specific roles to each member of the group. Practise some structures and vocabulary for each role (e.g., facilitator, recorder, timekeeper, summarizer/presenter). Rotate the roles within each group.
<p>1.4 extend their knowledge of the world</p> <p>1.4.1 <i>Discover and Explore</i></p> <ul style="list-style-type: none">❖ explore alternative classification systems and criteria for categories❖ discover relationships and patterns	<ul style="list-style-type: none">➤ Place the name of a profession on the back of each student in the class. Have students circulate in the class, asking each other questions in order to determine what their profession is. Alternatively, place the name of a profession on the back of one student, who comes to the front of the class. The student shows the tag with the profession to the other students in the class and then asks questions of the other students in order to determine what his/her profession is.➤ Have students play “Jeopardy” with categories being the themes studied in class (e.g., professions, weekend activities, health and safety, sports, etc.). Divide the students into teams. One team chooses a category, a definition or answer is given by the teacher, and the team must provide the appropriate question (e.g., Definition: <i>Ayuda las personas enfermas</i>. Question: <i>¿Eres enfermera?</i>)➤ Have students do a personal career questionnaire based upon careers for which they are best suited.



SUGGESTIONS FOR ASSESSMENT

- When students assume a variety of roles in groups, provide students with questions to assess self and group cooperation (see Appendices A and B).

- When students play “¿Quién soy yo?” with professions, note the extent to which
 - questions are varied and relevant
 - questions are understood by the class

- When students play games such as “Jeopardy,” look for evidence that they are able to ask questions to clarify understanding.

SUGGESTED LEARNING RESOURCES

¡En español! 2
 Unidad 6, Etapa 1
¡Buen Viaje! 2
 Capítulo 14



PRESCRIBED OUTCOMES	SUGGESTIONS FOR INSTRUCTION
<p>1.4 extend their knowledge of the world (continued)</p> <p>1.4.2 <i>Gather and Organize Information</i></p> <ul style="list-style-type: none">❖ compare and contrast items in simple ways❖ compose questions to guide research❖ identify sources of information❖ record observations <p>1.4.3 <i>Solve Problems</i></p> <ul style="list-style-type: none">❖ recognize and describe a problem, then propose solutions❖ understand and use the steps in the problem-solving process	<ul style="list-style-type: none">➤ Provide students with pictures of people involved in typical activities involving a daily routine (e.g., getting up, getting dressed, brushing teeth, having breakfast, etc.). Together or in groups, have students arrange photos into a logical sequence. Provide the appropriate reflexive verbs with the pictures or discuss these verbs as photos are arranged into sequence. As an extension, have students work in pairs to prepare a <i>sainete</i> entitled “<i>Un día en la vida de _____</i>.” Students create a day in the life of a famous person and present it to the class, with one person narrating and the other miming the actions.➤ Have students examine a resumé in Spanish, identifying the main categories given. Have students then prepare an imaginary resumé for a profession of their choice. <ul style="list-style-type: none">➤ Have students form groups and provide each group with a number of scenarios that involve a problem that requires a solution:<ul style="list-style-type: none">• A patient goes to see a doctor for an illness. As the doctor, what advice would you give?• You have been given a weekend curfew which you feel is too early and you have a particular activity planned which will go past your curfew. How do you resolve the problem?• Your parents have chosen a particular type of summer vacation. You would like a different type of vacation.➤ Have students develop a solution for the problem. As an extension, students could create a skit based on the scenario for which they have proposed a solution.



SUGGESTIONS FOR ASSESSMENT

SUGGESTED LEARNING RESOURCES

- As students work in pairs to sequence daily activities and then present them in the form of mime and narration, look for evidence that
 - students sequence the daily activities logically
 - actions performed by the “actor” correspond to the narration

- Provide students with a rubric, highlighting key points of a resumé. Assess resúmenes for
 - completeness—all appropriate detail is included
 - clarity—information is clear and easy to follow
 (See criteria for assessment of written material in Classroom Assessment, p. 12.)

- As students work in groups to find solutions for situational problems, look for evidence that they are able to
 - clearly identify the problem
 - propose a variety of solutions
 - choose one solution

¡Dime! Más
Unidad 8, Lección 1

¡Buen Viaje! 1B
Capítulo 12
Rutina diaria

¡Buen Viaje! 3
Capítulo 2, p.62–65

Planet@ 2
Tema 2, pp. 47–49



PRESCRIBED OUTCOMES	SUGGESTIONS FOR INSTRUCTION
<p>1.4 extend their knowledge of the world (continued)</p> <p>1.4.4 <i>Explore Opinions and Values</i></p> <ul style="list-style-type: none">❖ express their views on a variety of topics within their direct experience❖ gather opinions on a topic within their direct experience	<p>➤ As part of a discussion about professions/occupations, have students individually choose one profession that they feel would be ideal or the best job for them. Have them write three reasons why they have chosen that particular job. Then have students work in pairs or in groups of three or four to share the chosen professions and reasons for the choices. Have groups put their choices and main reasons on poster paper and display them in the class.</p>
<p>1.5 imaginative purposes and personal enjoyment</p> <p>1.5.1 <i>Humour/Fun</i></p> <ul style="list-style-type: none">❖ use the language for fun and to interpret humour (e.g., play a variety of sports and games, both indoors and out) <p>1.5.2 <i>Creative/Aesthetic Purposes</i></p> <ul style="list-style-type: none">❖ use the language creatively and for aesthetic purposes (e.g., write poems based on simple, repetitive, and modelled language)	<p>➤ Have students create a comic that depicts a humorous problem that might occur during a vacation, or have students create a humorous comic that represents a common misuse of a <i>falso amigo</i>-cognate (e.g., <i>Estoy embarazada</i>).</p> <p>➤ Have students create a collage or draw a picture of their favourite holiday activities or of their dream vacation spot.</p>



SUGGESTIONS FOR ASSESSMENT

SUGGESTED LEARNING RESOURCES

- As students work individually and then in groups to identify one ideal profession with three supporting reasons, look for evidence that students are able to
 - take turns, sharing chosen professions
 - provide three reasons for choice of profession
 - present chosen professions with reasons on poster paper in a clear, well-organized manner (language competence)
 - make reference to others' choices and reasons in comparison with their own

- Work with students to establish assessment criteria for a comic. Criteria might include the following:
 - cognate (*falso amigo*) is used in a humorous way
 - Spanish expression/vocabulary is used correctly (language competence, attend to form)
 - sentences are correctly constructed (language competence, attend to form)
 - spelling is accurate (language competence, attend to form)

- When students create a collage or draw a picture of their favourite holiday activities or of their dream vacation spot, look for evidence that they are able to
 - include pictures/illustrations
 - include words or phrases as labels

¡En español! 2
Video
Unidad 6, Etapa 1
En Contexto

¡Buen Viaje! 2
Capítulo 14
Profesiones y Oficios
pp. 398–401

¡Buen Viaje! 2
Video Episode 14
Profesiones y Oficios

Planet@ 2
Tema 2

Gessler Publishing Co. Inc.
New York
Comic Strips

Planet@ 1
pp. 30 and 102



PRESCRIBED OUTCOMES	SUGGESTIONS FOR INSTRUCTION
<p>1.5 imaginative purposes and personal enjoyment (continued)</p> <p>1.5.3 <i>Personal Enjoyment</i></p> <ul style="list-style-type: none">❖ use the language for personal enjoyment (e.g., listen to favourite songs in Spanish, view a music video, view a sports telecast in Spanish)	<ul style="list-style-type: none">➤ Have students do a personal project of their own choice (e.g., watch a movie in Spanish, find out about a favourite Spanish singer or soccer player). Have students submit a plan indicating what they expect to gain from the project, details, and timelines. Students keep a journal during the project.
<p>1.6 form, maintain, and change interpersonal relationships</p> <p>1.6.1 <i>Manage Personal Relationships</i></p> <ul style="list-style-type: none">❖ talk about themselves, and respond to the talk of others by showing attention or interest❖ make and break social engagements	<ul style="list-style-type: none">➤ Have students form two circles: an inner circle and an outer circle. Students begin by talking with the person opposite them. Discussion could be focused on weekend activities, daily routine, vacation plans, etc. <p>After students have spoken for two to three minutes, have members of the outer circle move clockwise. Students then begin a new discussion with a different partner.</p>



SUGGESTIONS FOR ASSESSMENT

**SUGGESTED LEARNING
RESOURCES**

- When students write a journal during the project, look for evidence that students are able to
 - express their impression on the cultural piece viewed or read
 - indicate what they have gained from it

- When students interact in casual exchanges with peers, look for evidence that they
 - speak Spanish
 - make an effort to speak during the whole time assigned



Notes

*LANGUAGE
COMPETENCE
YEAR 3*



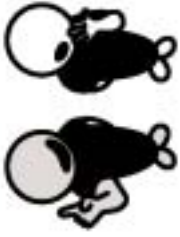

Language Competence

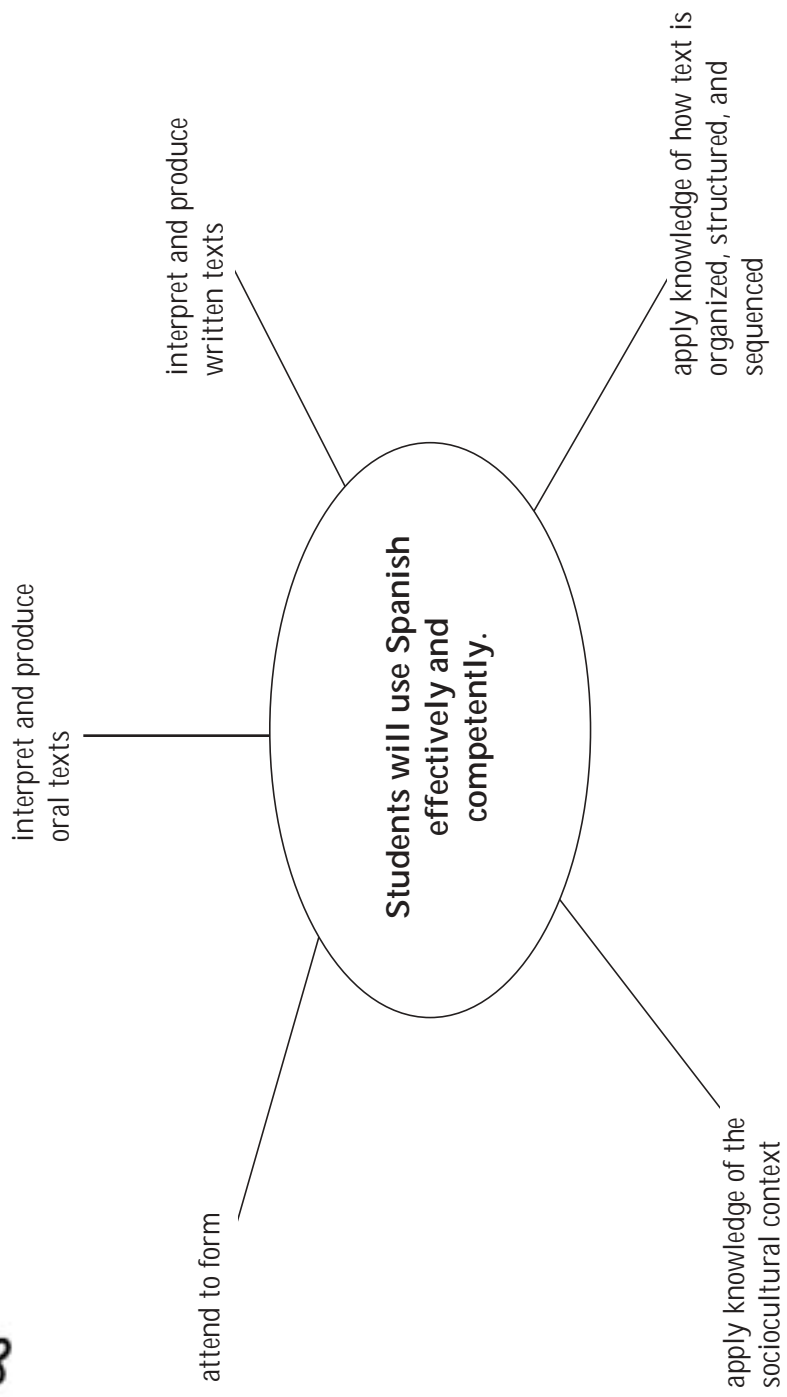



LANGUAGE COMPETENCE

General Outcome 2: Students will use Spanish effectively and competently.

Language competence is a broad term that includes linguistic or grammatical competence, discourse competence, sociolinguistic or sociocultural competence, and what might be called textual competence. The specific outcomes under Language Competence deal with knowledge of the Spanish language and the ability to use that knowledge to interpret and produce meaningful texts appropriate to the situation in which they are used. Language competence is best developed in the context of activities or tasks where the language is used for real purposes, in other words, in practical **applications**.

The various components of language competence are grouped under four cluster headings—see the illustration on the preceding page. Under each of these headings there are several strands. Each strand deals with a single aspect of language competence. For example, under the cluster heading **attend to form**, there is a strand for phonology (pronunciation, stress, intonation), orthography (spelling, mechanical features), lexicon (vocabulary words and phrases), and grammatical elements (syntax and morphology).

Although the outcomes isolate these individual aspects, language competence should be developed through learning activities that focus on meaningful uses of the Spanish language and on **language in context**. Tasks will be chosen based on the needs, interests, and experiences of students. The vocabulary, grammar structures, text forms, and social conventions necessary to carry out a task will be taught, practised, and assessed as students are involved in various aspects of the task itself, **not in isolation**.

Strategic competence is often closely associated with language competence, since students need to learn ways to compensate for low proficiency in the early stages of learning if they are to engage in authentic language use from the beginning. This component is included in the language use strategies in the Strategies section.



PRESCRIBED OUTCOMES	SUGGESTIONS FOR INSTRUCTION
<p>General Outcome 2: Language Competence Students will use Spanish effectively and competently.</p> <p>2.1 attend to form</p> <p>2.1.1 <i>Phonology</i></p> <ul style="list-style-type: none">❖ recognize some critical sound distinctions that are important for meaning (e.g., minimal pairs [<i>pero/perro, niño/niña</i>])❖ recognize some of the effects that intonation and stress have in different situations (e.g., <i>papa/papá</i>)❖ approximate the pronunciation of unfamiliar words <p>2.1.2 <i>Orthography</i></p> <ul style="list-style-type: none">❖ recognize and use some basic spelling patterns	<p>➤ First, model the use of specific sound distinctions in two sentences where meaning is changed as a result of pronunciation. Guide students to identify the differences. For example:</p> <p style="padding-left: 40px;"><i>El niño está enfermo.</i> <i>La niña está enferma.</i></p> <p style="padding-left: 40px;"><i>¿Por qué vas?</i> <i>Porque quiero.</i></p> <p style="padding-left: 40px;"><i>El perro va a la casa.</i> <i>Pero va a la casa.</i></p> <p>Then, provide a list of vocabulary to focus on the following critical sound distinctions: <i>e/i, g/j, ll, ñ, r, z</i>. Do some modelled drills and then ask students to use the vocabulary list in the following situations:</p> <ul style="list-style-type: none">• At the doctor’s office: A doctor’s visit in Spain, Argentina, Cuba, etc.• Social life: Role play an interview with an exchange student from Spain, Argentina, Mexico, etc. <p>➤ Students practice target vocabulary by playing games such as “Hangman” (“<i>El ahorcado</i>”), spelling bee, etc.</p>



SUGGESTIONS FOR ASSESSMENT

SUGGESTED LEARNING RESOURCES

- Prepare an observation checklist. Observe the students' ability to reproduce appropriately in context the following critical sound distinctions:
 - *i/e*
 - *g/j*
 - *ll*
 - *ñ*
 - *r*
 - *z*

- Look for evidence that students spell target vocabulary accurately in a variety of situations.

Colección tiempo: Para pronunciar



PRESCRIBED OUTCOMES	SUGGESTIONS FOR INSTRUCTION
<p>2.1 attend to form (continued)</p> <p>2.1.3 <i>Lexicon</i></p> <ul style="list-style-type: none">❖ use a repertoire of words and phrases in familiar contexts that meet the needs and interests of students, particularly within the following areas of experience:<ul style="list-style-type: none">— travel<ul style="list-style-type: none">✓ vacations✓ directions— social life— health and safety<ul style="list-style-type: none">✓ physical states✓ visits to the doctor— occupations and professions❖ experiment and use a variety of words and expressions in familiar contexts	<p>➤ Have students continue the use of a personal dictionary for each area of experience.</p>



SUGGESTIONS FOR ASSESSMENT

- Use student conferencing to discuss each student's dictionary with him/her.

SUGGESTED LEARNING RESOURCES

USO interactivo del vocabulario

Colección tiempo: Para pronunciar

Rosetta Stone I and II



PRESCRIBED OUTCOMES	SUGGESTIONS FOR INSTRUCTION
<p>2.1 attend to form (continued)</p> <p>2.1.4 <i>Grammatical Elements</i></p> <ul style="list-style-type: none">❖ use, in modelled situations, the following grammatical elements:<ul style="list-style-type: none">— commands—negative forms— commands—irregular verbs (<i>tú</i> form)— stem-changing verbs in the present tense— irregular verbs: <i>dar, poner, traer</i>— preterite tense (regular verbs)— perfect tense— direct object pronouns— reflexive verbs	<p>Modelled Situations: This term is used to describe learning situations where a model of specific grammatical elements is consistently provided and immediately available. Students in such situations will have an emerging awareness of the grammatical elements and be able to apply them in very limited situations. Limited fluency and confidence characterize student language.</p> <p>Example of a modelled situation:</p> <p>In preparation for a group project, students will keep a journal of their daily activities for a week. Students practise the structure “<i>tener que + infinitive</i>” using the sentence patterns provided. Each student asks five classmates, <i>¿Qué tienes que hacer después de clases hoy?</i> Students answer saying, <i>Tengo que . . .</i>, with an infinitive of their choice. Each person then summarizes the results of their mini survey, <i>Tres estudiantes tienen que estudiar</i>, and so on.</p>



SUGGESTIONS FOR ASSESSMENT

**SUGGESTED LEARNING
RESOURCES**

*USO de la gramática española:
Junior intermedio*
Rosetta Stone I and II



PRESCRIBED OUTCOMES	SUGGESTIONS FOR INSTRUCTION
<p>2.1 attend to form (continued)</p> <p>2.1.4 <i>Grammatical Elements (continued)</i></p> <ul style="list-style-type: none">❖ use, in structured situations, the following grammatical elements:<ul style="list-style-type: none">— <i>nos/les (os) gusta/an</i>— <i>caer bien/mal</i>— possessive adjectives and pronouns: <i>nuestro/a/os/as, vuestro/a/os/as</i>— irregular verbs: <i>poder, conocer, saber, venir, salir, decir, hacer, preferir</i>— commands—regular verbs (<i>tú</i> form)— commands for commonly used verbs (<i>usted, ustedes</i>)— present progressive (<i>estar + gerund</i>)— demonstrative adjectives and pronouns: <i>este/a, ese/a, aquel/la, estos/as, esos/as, aquellos/as</i>	<p>Structured Situations: This term is used to describe learning situations where a familiar context for the use of specific grammatical elements is provided and students are guided in their use. Students in such situations will have increased awareness and emerging control of the grammatical elements and be able to apply them in familiar contexts with teacher guidance. Student language is characterized by increasing fluency and confidence.</p> <p>Example of a structured situation:</p> <p>In preparation for a research project on typical activities of young people in selected Spanish-speaking countries, students listen to a rapid conversation where a Canadian student is talking to an exchange student from Mexico. The students check off, on a prepared answer sheet, what the exchange student does and does not do.</p>
<p>N.B.</p> <p>Ensure students are aware that <i>usted</i> is used throughout Latin America but <i>vosotros/as</i> is used in Spain. However, for general classroom practice choose to use one or the other and do so consistently.</p>	



SUGGESTIONS FOR ASSESSMENT

**SUGGESTED LEARNING
RESOURCES**

*Uso de la gramática española:
Junior intermedio*

Colección tiempo: Para pronunciar

Rosetta Stone I and II



PRESCRIBED OUTCOMES	SUGGESTIONS FOR INSTRUCTION
<p>2.1 attend to form (continued)</p> <p>2.1.4 <i>Grammatical Elements (continued)</i></p> <ul style="list-style-type: none">❖ use, in independent situations, the following grammatical elements:<ul style="list-style-type: none">— <i>me/te/le-gusta/an</i>— commonly used verbs: <i>ir, querer</i>— regular <i>ir</i> and <i>er</i> verbs in the present tense— <i>tener que</i> + infinitive— <i>ir + a</i> + infinitive— definite and indefinite articles: <i>el, la, lo, las, los, un, una, unas, unos</i>— possessive adjectives: <i>mi, tu, su, mis, tus, sus</i>	<p>Independent Situations: This term is used to describe learning situations where students use specific grammatical elements in a variety of contexts with limited teacher guidance. Students in such situations will have consistent control of the grammatical elements and be able to apply them in a variety of contexts with limited teacher guidance. Fluency and confidence characterize student language.</p> <p>Example of an independent situation: Students send a letter, an email message, or a recorded message to a Spanish-speaking pen pal explaining what they do regularly.</p>



SUGGESTIONS FOR ASSESSMENT

**SUGGESTED LEARNING
RESOURCES**

--



PRESCRIBED OUTCOMES	SUGGESTIONS FOR INSTRUCTION
<p>2.2 interpret and produce oral texts</p> <p><i>2.2.1 Aural Interpretation</i></p> <ul style="list-style-type: none">❖ understand short, simple texts in guided and unguided situations <p><i>2.2.2 Oral Production</i></p> <ul style="list-style-type: none">❖ produce short, simple texts in guided situations	<ul style="list-style-type: none">➤ Have students listen to radio ads for trips or vacation destinations. Individually, have students identify the main activities/positive characteristics, etc. of the destination. Then have students work in pairs to share information and represent the main points of the ad visually. ➤ Have students listen to an ad by a department store advertising shopping specials. Then have students work in pairs to identify the goods advertised and their prices. ➤ Have students prepare role plays, based on the themes studied:<ul style="list-style-type: none">• At the doctor’s office• Interview with a famous person about his/her daily routine• Parent and child negotiating acceptable activities and curfews for the weekend• Planning a date or an activity with a friend on the phone• Shopping for food or clothing.



SUGGESTIONS FOR ASSESSMENT

- As students listen to radio ads for vacation destinations, look for evidence that they are able to
 - identify main activities
 - provide relevant details
 - include key words and phrases as labels for visual interpretation (language competence, production)

- After students listen to an ad by a department store, check to see that prices of goods were accurately heard.

- Discuss criteria with students before they role-play a variety of situations related to themes studied. The teacher may wish to develop a checklist students can use for self and peer assessment. Criteria might include the following:
 - meaning is clear
 - appropriate details are included in questions and answers
 - gestures and body language support communication (language competence, sociocultural context)
 - pronunciation and intonation are generally accurate (language competence, attend to form)
 - interaction has some sense of fluency and spontaneity (language competence, interactive fluency) (strategies)

(See examples of role-play criteria in Classroom Assessment, p. 11.)

SUGGESTED LEARNING RESOURCES

--



PRESCRIBED OUTCOMES	SUGGESTIONS FOR INSTRUCTION
<p>2.2 interpret and produce oral texts (continued)</p> <p>2.2.3 <i>Interactive Fluency</i></p> <ul style="list-style-type: none">❖ engage in simple interactions ❖ manage simple, routine interactions without undue difficulty	<ul style="list-style-type: none">➤ Invite students to improvise social situations (e.g., greetings, family dinners, tourist behaviour, shopping). Students could pick a card that suggests situations to role-play that demonstrate behaviour that is culturally appropriate in Spanish-speaking countries. ➤ Suggest that students work in pairs to role-play telephone conversations in which they plan weekend activities. Partners should find activities both students would enjoy. Plans could include where they would go, who will go with them, when they will leave, and what they will take along (BC <i>Resource Package</i>, 74).
<p>2.3 interpret and produce written texts</p> <p>2.3.1 <i>Written Interpretation</i></p> <ul style="list-style-type: none">❖ understand short, simple texts in guided and unguided situations	<ul style="list-style-type: none">➤ Have students form groups of three or four. Provide each group with the written text of a postcard written by travellers to various Spanish-speaking countries. Have students read the text together and try to determine the country visited, based on information given.



SUGGESTIONS FOR ASSESSMENT

SUGGESTED LEARNING RESOURCES

- When students improvise/role-play social situations, look for evidence that they are able to
 - make themselves understood in Spanish
 - keep conversation going without long pauses
 - recognize and respond to familiar words and patterns
 - use learned patterns and vocabulary (language competence, attend to form)
 - take risks to add details or use unfamiliar language

- When students prepare telephone conversations to plan weekend activities, discuss criteria with students before they begin. Criteria might include the following:
 - who, what, where, and when (relevant details of plans) are clearly identified
 - questions and answers are clearly formulated

- As students work in groups with a postcard written by a traveller from a Spanish-speaking country, look for evidence that they are able to
 - select key information (words, expressions) to determine the visited country
 - make a logical choice of which country was visited, based on information provided

¡En español! 1
Unidad 3, Etapa 1

¡Dime! Uno
Video
Unidad 3, Lección1

Planet@ 1
Tema 4
pp. 94–96

¡En español! 2
Etapa preliminar, Unidad 1
Resource Book, pp. 2, 3



SUGGESTIONS FOR ASSESSMENT

- Work with students to develop a simple checklist they can use for self and peer assessment of their letters, postcards, or emails. The checklist might include items such as the following:
 - meaning is clear
 - greeting and closing are appropriate (language competence, discourse)
 - punctuation is appropriate (language competence, attend to form)
 - spelling, including accents, is correct (language competence, attend to form)

(See examples of checklist criteria in Classroom Assessment, p. 12.)

- When students prepare a report about a profession in which they are interested, provide them with a checklist for self and peer assessment. Criteria might include the following:
 - main topics/sections are clearly identified
 - relevant detail about each section is provided
 - sentence structure is accurate (language competence, attend to form)
 - spelling is accurate (language competence, attend to form)

- When students choose a photo of a vacation destination and vacation activities, look for evidence that they are able to
 - provide key information and relevant details to describe the chosen photo
 - provide relevant reasons for their choice of photo
 - interpret elements in the photo

SUGGESTED LEARNING RESOURCES

Internet
Chicos Chicas, Nivel 1
 p. 24
 <www.postales.com>

Planet@ 2
 Tema 2

¡Buen Viaje! 3
 Capítulo 1, pp. 1–7
 Photos
 Brochures from Travel Agencies

Planet@ 2
 Tema 4



PRESCRIBED OUTCOMES	SUGGESTIONS FOR INSTRUCTION
<p>2.3 interpret and produce written texts (continued)</p> <p>2.3.4 <i>Representation</i></p> <ul style="list-style-type: none">❖ express meaning through the use of visual elements in a variety of media in guided and unguided situations	<ul style="list-style-type: none">➤ Have students create a poster giving information about a particular disease. Information could include symptoms, remedies, where to get more information, etc. Have students use the imperative to provide preventative measures. ➤ Have students create a poster entitled "All about me." / " <i>Todo sobre mí.</i>" Information could include the following:<ul style="list-style-type: none">• Social activities that I enjoy / <i>Las actividades sociales que me gustan</i>• My daily routine / <i>Mi rutina diaria</i>• My favourite or dream vacations / <i>Mis vacaciones favoritas o soñadas</i>• My possible future profession(s) / <i>Mi(s) futura(s) profesión(es) posible(s)</i> ➤ Have students program a song or choreography entitled "yo."



SUGGESTIONS FOR ASSESSMENT

- When students prepare a poster giving information about a particular disease, discuss criteria with students before they begin. Criteria might include the following:
 - illustrations enhance the message of the text
 - name of disease and subtopics are clearly identified (language competence, written production)
 - relevant details are provided for each subtopic (language competence, written production)
 - imperative is used correctly to provide preventative measures (language competence, attend to form)
 - layout/design is neat and organized, with good use of space

- When students create a poster about themselves, discuss criteria with students before they begin. Criteria might include the following:
 - relevant information for each subtopic about oneself is provided
 - illustrations enhance the message of the text
 - layout/design is neat and organized, with good use of space
 - appropriate and accurate vocabulary is used

- When students perform a song or choreography, discuss criteria with students before they begin. Criteria might include the following:
 - lyrics convey the message about oneself
 - appropriate and accurate vocabulary is used
 - visual elements in the choreography correspond to the text

SUGGESTED LEARNING RESOURCES

Planet@ 2
 Tema 4
 pp. 110–117



PRESCRIBED OUTCOMES	SUGGESTIONS FOR INSTRUCTION
<p>2.4 apply knowledge of the sociocultural context</p> <p>2.4.1 <i>Register</i></p> <ul style="list-style-type: none">❖ experiment with and use formal and informal language in familiar situations <p>2.4.2 <i>Idiomatic Expressions</i></p> <ul style="list-style-type: none">❖ use learned idiomatic expressions in new contexts to enhance communication <p>2.4.3 <i>Variations in Language</i></p> <ul style="list-style-type: none">❖ identify some specific regional variations in language❖ experience a variety of accents and variations in speech <p>2.4.4 <i>Social Conventions</i></p> <ul style="list-style-type: none">❖ interpret and use important conventions in various social interactions <p>2.4.5 <i>Non-verbal Communication</i></p> <ul style="list-style-type: none">❖ recognize and use appropriate non-verbal behaviours in a variety of familiar contexts (e.g., eye contact, waving)❖ recognize and avoid using non-verbal behaviours that are considered impolite	<ul style="list-style-type: none">➤ As students prepare various role plays (e.g., at the doctor's office, planning an activity with a friend), review with students the appropriate level of formality in different situations. Provide students with expressions that would be appropriate in formal and informal situations.➤ As students prepare role plays about visiting the doctor's office, provide them with specific idiomatic expressions related to illness (e.g., <i>Me duele ...</i> + parts of body, <i>Estoy enfermo</i>, etc.).➤ As students research and prepare different Spanish-speaking countries as vacation destinations, discuss different expressions that are used in different countries to identify transportation methods (e.g., <i>autobús, guagua, camión, colectivo</i>).➤ Provide students with various social conventions (e.g., invitations, dating, going to movies, addressing elders, etc.). Then have students role-play social interactions.➤ Have students mime the various gestures that are associated with being ill (e.g., holding your head when you have a headache).



SUGGESTIONS FOR ASSESSMENT	SUGGESTED LEARNING RESOURCES
<ul style="list-style-type: none"> ➤ Look for evidence that students use formal and informal register appropriately in their role plays. 	<p><i>¡Dime! Uno</i> Unidad 7, Lección 2 Video, Unidad 7, Lección 2</p>
<ul style="list-style-type: none"> ➤ Look for evidence that students use provided simple idiomatic expressions accurately in their role play. 	<p><i>¡Buen Viaje! 1B</i> Capítulo 8</p>
<ul style="list-style-type: none"> ➤ Look for evidence that students identify some specific regional variations in language of the destination country. 	<p><i>Planet@ 2</i> Tema 4, pp. 110–117</p>
<ul style="list-style-type: none"> ➤ Look for evidence that students use conventions provided appropriately. 	<p><i>Planet@</i> Sección: Versión Mercosur</p>
<ul style="list-style-type: none"> ➤ Look for evidence that students use gestures accurately to convey their message. 	<p><i>¡Buen Viaje! 1B</i> Capítulo Diccionario de gestos</p>



PRESCRIBED OUTCOMES	SUGGESTIONS FOR INSTRUCTION
<p data-bbox="103 281 558 384">2.5 apply knowledge of how text is organized, structured, and sequenced</p> <p data-bbox="103 407 415 436">2.5.1 <i>Cohesion/Coherence</i></p> <ul data-bbox="175 464 506 564" style="list-style-type: none">❖ link several sentences coherently (e.g., on a single theme) <p data-bbox="103 947 318 976">2.5.2 <i>Text Forms</i></p> <ul data-bbox="175 1003 532 1245" style="list-style-type: none">❖ recognize and use a variety of text forms, in guided and unguided situations (e.g., travel brochures, personal letters, multimedia presentations)	<p data-bbox="605 464 1414 596">➤ As students establish the order of activities that are part of the daily routine, introduce important sequential markers such as <i>primero, después, luego, entonces, por último, más tarde</i>.</p> <p data-bbox="605 1003 1411 1140">➤ Provide students with a model of a haiku poem or a cinquain poem. Then have them create their own haiku or cinquain poem about a favourite social activity, a daily activity, an interesting profession, etc.</p> <ul data-bbox="659 1157 1382 1629" style="list-style-type: none">• <i>Haiku</i>: 5 syllables 7 syllables 5 syllables• <i>Cinquain</i>: Line 1—One word (noun)—Tells what poem is about Line 2—Two words (adjectives)—Describe the word in Line 1 Line 3—Three words (verbs)—Give action words (associated with Line 1) Line 4—Four words—Express feelings or thoughts (about line 1) Line 5—One word (noun)—Gives a synonym of the word in Line 1



SUGGESTIONS FOR ASSESSMENT

SUGGESTED LEARNING RESOURCES

- When students organize activities of a daily routine and use sequential markers, look for evidence that they are able to
 - organize daily activities into a chronological sequence
 - use appropriate sequential markers

- When students create their own poems based on models provided, discuss criteria with students before they begin. Criteria might include the following:
 - model has been followed
 - appropriate and accurate vocabulary is used (language competence, attend to form)

¡En español! 1
Unidad 5, Etapa 1

¡Dime! Más
Unidad 8, Lección 1

¡Dime! Uno
Video
Unidad 3, Lección 3

¡Buen Viaje! 1B
Capítulo 12

Planet@ 1
Tema 4

¡En español! 1
Unidad 3, Etapa 1

¡Dime! Uno
Unidad 3



PRESCRIBED OUTCOMES	SUGGESTIONS FOR INSTRUCTION
<p data-bbox="102 281 560 386">2.5 apply knowledge of how text is organized, structured, and sequenced (continued)</p> <p data-bbox="102 407 527 441"><i>2.5.3 Patterns of Social Interaction</i></p> <ul data-bbox="175 464 560 814" style="list-style-type: none"><li data-bbox="175 464 560 598">❖ use simple conventions to open and close conversations and to manage turn-taking<li data-bbox="175 604 560 814">❖ initiate interactions, and respond using a variety of social interaction patterns (e.g., social invitations, ordering food in restaurant)	<p data-bbox="605 464 1414 604">➤ Have students work in pairs to prepare an invitation to a special event that could be sent via email. If possible, have students send the message to another pair of students in the class, who must then respond to the invitation.</p>



SUGGESTIONS FOR ASSESSMENT

SUGGESTED LEARNING RESOURCES

- When students prepare an invitation to a special event, create a rubric or checklist to assess both the invitation and the response. Assessment criteria for the invitation might include the following:
 - key information is provided (who, what, where, when)
 - vocabulary and structures required to arrange meeting times and places are used correctly (language competence, attend to form)
 - sentence structure is accurate (language competence, attend to form)
 - spelling is accurate (language competence, attend to form)

(See examples of criteria to assess written material in Classroom Assessment, p. 12.)
- Assessment criteria for the response might include the following:
 - a clear response is given
 - sentence structure is accurate (language competence, attend to form)
 - vocabulary and structures required to arrange meeting times and places are used correctly (language competence, attend to form)
 - spelling is accurate (language competence, attend to form)

Internet
Chicos Chicas, Nivel 1
 <www.postales.com>



Notes

*GLOBAL
CITIZENSHIP
YEAR 3*



Global Citizenship



study historical and contemporary elements of Spanish-speaking cultures

affirm diversity

Students will acquire the knowledge, skills, and attitudes to be effective global citizens, through the exploration of the cultures of the Spanish-speaking world.

explore personal and career opportunities



GLOBAL CITIZENSHIP

General Outcome 3: Students will acquire the knowledge, skills, and attitudes to be effective global citizens, through the exploration of the cultures of the Spanish-speaking world.

The outcomes for Global Citizenship deal with a broad range of knowledge, skills, and attitudes needed to be effective global citizens—in other words, with the development of intercultural competence. The concept of global citizenship encompasses citizenship at all levels, from the local school and community to Canada and the world.

The various components of global citizenship are grouped under three cluster headings—see the illustration on the preceding page. Under each of these headings there are several strands. Each strand deals with a single aspect of intercultural competence. For example, under the cluster heading **study historical and contemporary elements of Spanish-speaking cultures**, there are strands for the processes and methods of acquiring knowledge about Spanish-speaking cultures, the cultural knowledge thus acquired, applications of that knowledge to aid comprehension and to communicate in appropriate ways, positive attitudes toward Spanish-speaking cultures, as well as knowledge of the diversity within those cultures.

Developing cultural knowledge and skills is a lifelong process. Knowledge of one's own culture is acquired over a lifetime. Cultures change over time. Within any national group, there may be a dominant culture or cultures and a number of minority cultures. Rather than try to develop an extensive bank of knowledge about the Spanish-speaking cultures, it is more important for students to learn the processes and methods of accessing and analyzing cultural practices. Students will gain cultural knowledge in the process of developing these skills. In this way, if they encounter elements of the Spanish-speaking cultures they have not learned about in class, they will have the skills and abilities to deal with them effectively and appropriately.

The **affirm diversity** heading covers knowledge, skills, and attitudes that are developed as a result of bringing other languages and cultures into relationship with one's own. There is a natural tendency, when learning a new language and culture, to compare it with what is familiar. Many students leave a second language learning experience with a heightened awareness and knowledge of their own language and culture. They will also be able to make some generalizations about languages and cultures based on their experiences and those of their classmates who may have a variety of cultural backgrounds. This will provide students with an understanding of diversity within both a global and a Canadian context.



PRESCRIBED OUTCOMES	SUGGESTIONS FOR INSTRUCTION
<p>General Outcome 3: Global Citizenship</p> <p>Students will acquire the knowledge, skills, and attitudes to be effective global citizens through the exploration of the cultures of the Spanish-speaking world.</p> <p>3.1 study historical and contemporary elements of Spanish-speaking cultures</p> <p>3.1.1 <i>Access/Analyze Cultural Knowledge</i></p> <ul style="list-style-type: none">❖ compare and make connections between some elements of Spanish-speaking cultures being studied and their own (e.g., geography and climate) <p>3.1.2 <i>Knowledge of Spanish-Speaking Cultures</i></p> <ul style="list-style-type: none">❖ identify some things they have in common with people their own age who live in Spanish-speaking nations❖ explore some elements of Spanish-speaking cultures (e.g., influence of the geography and climate on their way of life)	<p>➤ Brainstorm with students for a list of current popular Spanish-speaking entertainers, artists, politicians, athletes, etc. Then provide students with the names of several important historical Spanish-speaking figures. Have students choose one person of the past and one of the present and have them find basic biographical information on each. Based on the information found, have students imagine the daily routine/life of each person. Students either write a journal entry as each character or prepare a simple skit illustrating the daily routine of each character. Discuss with students differences in lifestyle of the past and of the present.</p> <p>➤ Brainstorm with students about the types of questions they would like to ask Spanish-speaking young people, if they had the opportunity (e.g., social life, friends, school, daily routine, opportunities for the future—careers, etc.). Give students the opportunity to pair up with a penpal either through the Internet or through the post. Have students write to Spanish-speaking youth to find the answers to their questions.</p>



SUGGESTIONS FOR ASSESSMENT

SUGGESTED LEARNING RESOURCES

- When students present the daily routine of a famous person of the past and of a contemporary figure, look for evidence that they are able to
 - incorporate key activities that are part of the daily routine of both individuals
 - identify differences and similarities in the daily activities, based on character and time period lived

- When students formulate questions, look for evidence that
 - questions are relevant and clear
 - resources are used effectively
 - analysis supports or refutes assumptions about Spanish-speaking cultures

Internet

¡Dime! Pasaporte al mundo 21



PRESCRIBED OUTCOMES	SUGGESTIONS FOR INSTRUCTION
<p>3.1 study historical and contemporary elements of Spanish-speaking cultures (continued)</p> <p>3.1.2 <i>Knowledge of Spanish-Speaking Cultures (continued)</i></p> <ul style="list-style-type: none">❖ identify some things they have in common with people their own age who live in Spanish-speaking nations❖ explore some elements of Spanish-speaking cultures (e.g., influence of the geography and climate on their way of life) <p>3.1.3 <i>Apply Cultural Knowledge</i></p> <ul style="list-style-type: none">❖ identify commonalities and differences between the Spanish-speaking cultures being studied and their own❖ apply knowledge of Spanish-speaking cultures to interpret similarities and differences between those cultures and their own (e.g., interpret stories, television, or films; interview a visitor)	<p>➤ Have students simulate being agents for an international Andean musician or musical group and plan an itinerary for a concert tour as well as the promotion of the tour. Divide the class into groups to research music in the Andean world (e.g., instruments, type of music, artists) in the present and past.</p> <p>Have students create a poster of their star, a cultural briefing for the star describing important cultural customs and musical contributions (e.g., instruments), a sound track, and the itinerary. Tasks can be distributed among groups.</p> <p><i>Variations:</i> Have students simulate being agents for a Spanish rock star or any other type of music of Spanish-speaking culture.</p> <p>Invite a local musical group from the Spanish-speaking world to do a concert and discuss their art.</p> <p>➤ Have students view Spanish game shows or movies. Have them identify cultural differences and similarities in the interactions between people.</p>



SUGGESTIONS FOR ASSESSMENT

SUGGESTED LEARNING RESOURCES

- When students simulate being agents for an international musician, look for evidence that they are able to
 - identify musical contributions of Spanish-speaking cultures
 - analyze musical contributions of Spanish-speaking cultures on global society

- As students view Spanish game shows and movies, look for evidence that they are able to
 - identify key differences
 - identify important similarities
 - present similarities and differences to the class

Local Spanish Television Channels



PRESCRIBED OUTCOMES	SUGGESTIONS FOR INSTRUCTION
<p>3.1 study historical and contemporary elements of Spanish-speaking cultures (continued)</p> <p>3.1.4 <i>Diversity of Spanish-Speaking Cultures</i></p> <ul style="list-style-type: none">❖ identify commonalities and differences among diverse Spanish-speaking groups❖ apply knowledge of Spanish-speaking cultures to interpret similarities and differences among diverse groups <p>3.1.5 <i>Value Spanish-Speaking Cultures</i></p> <ul style="list-style-type: none">❖ identify similarities between themselves and people of Spanish-speaking cultures being studied❖ express an interest in finding out about people their own age who speak Spanish	<p>➤ Have students work in groups to research the basic history of a Spanish-speaking country. Have students present their information in the form of a multimedia presentation.</p> <p>➤ Have students choose and research a topic that focuses on youth (e.g., dating, social activities/social life, etc.). Have students present their information through a video, multimedia presentation, magazine, etc. (This could be a part of the same research done for “Global Citizenship—identify some things they have in common with people their own age who live in Spanish-speaking nations, 3.1.2, pp. 3–52).</p>



SUGGESTIONS FOR ASSESSMENT

SUGGESTED LEARNING RESOURCES

- Provide students with a rubric outlining assessment criteria before they begin research project of a Spanish-speaking country's basic history.

Subtopics that might be included in the project could include the following:

- settlement
- colonization
- immigration
- government
- economy
- geography
- effects of world events
- important people

- When students present information about a topic that focuses on youth, look for evidence that
 - a clear understanding of cultural traditions for Spanish-speaking teens is evident
 - information is presented in an interesting and organized way
 - respect for diversity and differences in customs is maintained

¡Dime! Pasaporte al mundo 21
 In each unit, look for Sección:
 Del pasado al Presente

<www.e-thologies.com/>

Planet@ 1 and 2
 Sección: 350 millones



PRESCRIBED OUTCOMES	SUGGESTIONS FOR INSTRUCTION
<p>3.2 affirm diversity</p> <p>3.2.1 <i>Awareness of First Language</i></p> <ul style="list-style-type: none">❖ compare oral and written aspects of their first language and Spanish (e.g., grammatical structures)❖ identify some words in their first language that have been borrowed from other languages <p>3.2.2 <i>General Language Knowledge</i></p> <ul style="list-style-type: none">❖ recognize that languages can be grouped into families based on common origins❖ identify how and why languages borrow from one another <p>3.2.3 <i>Awareness of Own Culture</i></p> <ul style="list-style-type: none">❖ recognize and identify similarities and differences between their own culture and other cultures (e.g., occupations, seasonal activities)	<p>➤ Provide students with language structures they are learning in Spanish and language structures in their first language. Have students match the Spanish structure with a corresponding structure in their first language. Then have students compare and contrast the structures in both languages. Finally, have students complete a text in Spanish in which they must use the Spanish structures studied in the matching activity.</p> <p>➤ Have students view videos or films and listen to interviews or songs from different regions. After viewing or listening for the first time, have students work in pairs to identify the differences in pronunciation, vocabulary, etc. that they were able to note. Have them view or listen a second time, asking students to add to their original list. Discuss with the whole class which differences were noted. Have students prepare a written or oral summary of their findings.</p> <p>➤ Read several children’s stories from Spanish-speaking countries which depict a specific event (e.g., Christmas). Compare and contrast this event with the way in which different students celebrate the event. As an extension, students could create a story of their own celebration.</p>



SUGGESTIONS FOR ASSESSMENT

- When students compare structures in both languages, look for evidence that they
 - can identify differences and similarities between the two languages
 - use the Spanish structures studied

- As students view or listen to interviews or songs from different regions, look for evidence that they are adding an increasing number of details to their list of differences after each listening/viewing.

- Have students complete a *True/False* activity to ensure understanding of the celebration in their culture and in the Spanish-speaking countries.

SUGGESTED LEARNING RESOURCES

Internet /Website
 <www.caslt.org/research/musicsp.htm>

Hadaluna Lee website
 <www.andaluciaglobal.com>
 Imaginaria—Revista de Literatura Infantil y Juvenil
 <www.imaginaria.com.ar/>



PRESCRIBED OUTCOMES	SUGGESTIONS FOR INSTRUCTION
<p>3.2 affirm diversity (continued)</p> <p>3.2.4 <i>General Cultural Knowledge</i></p> <ul style="list-style-type: none">❖ recognize that speakers of the same language may come from different cultural backgrounds❖ recognize some of the factors that affect the culture of a particular region (e.g., geography, climate) <p>3.2.5 <i>Value Diversity</i></p> <ul style="list-style-type: none">❖ identify the limitations of adopting a single perspective	<p>➤ Have students complete a rural-urban study of a Spanish-speaking country (e.g., Buenos Aires vs. Patagonia).</p> <p>➤ Have students bring in an artifact, souvenir, postcard, etc. from a non-English or Spanish-speaking country that they have visited or would like to visit in the future. Have students present the artifact to the class.</p>



SUGGESTIONS FOR ASSESSMENT

- After students have completed a study about the differences in urban and rural life of a Spanish-speaking country, have students present their findings about cultural diversity within a country and have them complete a reflection journal. Questions for the journal might include the following:
 - What are some of the main differences you noted between urban and rural life?
 - What are some of the similarities you noted between urban and rural life?
 - What are some possible reasons for these differences?
 - Which lifestyle would you prefer and why?

- When students present an artifact, souvenir, or postcard, discuss assessment criteria before the presentation of the artifact. Look for evidence that
 - students present with enthusiasm
 - audience asks relevant questions
 - artifact is clearly named
 - use of artifact is clearly explained
 - origin of artifact is clearly explained
 - clear explanation is given of why this artifact is important
 - pronunciation and intonation are generally accurate

(Criteria 3-6 language competence, oral production, Criteria 7 language competence, attend to form)

SUGGESTED LEARNING RESOURCES

¡Buen Viaje! 2
 Capítulo 9
 Video, Episode 9

Planet@ 2
 Tema 1
 350 millones, p. 32



PRESCRIBED OUTCOMES	SUGGESTIONS FOR INSTRUCTION
<p>3.2 affirm diversity (continued)</p> <p>3.2.6 <i>Intercultural Skills</i></p> <ul style="list-style-type: none">❖ reflect on their actions and the consequences of their actions for others❖ explore how their perspective is shaped by a variety of factors	<p>➤ Invite students from a different grade level to view presentations (e.g., travel fair, role plays, explanation of games, etc.).</p>
<p>3.3 personal and career opportunities</p> <p>3.3.1 <i>Spanish Language and Spanish-Speaking Cultures</i></p> <ul style="list-style-type: none">❖ identify some careers for which knowledge of Spanish is useful❖ identify some places that they could visit where Spanish is spoken	<p>➤ Brainstorm with students the answers to the question “What careers require a knowledge of Spanish?” Have students work in pairs or small groups to prepare a poster and small informational brochure called “Careers and Spanish, what’s in it for you?”</p>



SUGGESTIONS FOR ASSESSMENT

- When students from other grade levels are invited to the class, look for evidence that the inviting students are
 - enthusiastic about their meeting with other students
 - speaking Spanish
 - asking questions of their guests and interested in the responses

- When students prepare a poster and brochure about careers that require a knowledge of Spanish, discuss assessment criteria before students begin. Provide students with guidelines of basic questions to which they must find the responses. Assessment criteria for brochure and poster might include the following:
 - information is accurate
 - relevant details are provided
 - appropriate vocabulary is used (language competence, attend to form)
 - spelling is accurate (language competence, attend to form)
 - brochure/poster is well-organized, with good use of space (language competence, representation)

SUGGESTED LEARNING RESOURCES

¡En español! 3
 Unidad 4, Etapa 2
 Vocabulary

¡Buen Viaje! 2
 Capítulo 14
 p. 414



PRESCRIBED OUTCOMES	SUGGESTIONS FOR INSTRUCTION
<p>3.3 personal and career opportunities (continued)</p> <p>3.3.2 <i>Cultural and Linguistic Diversity</i></p> <ul style="list-style-type: none">❖ identify some careers for which knowledge of different languages and cultures is useful❖ identify some countries where there is significant linguistic and cultural diversity	<p>➤ As students research professions that are of interest to them, have them also research one occupation/ profession that requires knowledge of another language and culture. Have students then create a classified ad for the job they researched. The ad should include job duties, requirements, salary, start date, hours of work, etc.</p>



SUGGESTIONS FOR ASSESSMENT

- When students prepare an ad for a job, provide students with a checklist for self and peer assessment. Criteria might include the following:
 - job duties are clearly defined
 - requirements are clearly outlined in relation to Spanish language and culture
 - salary is given
 - start date and hours of work are given

Upon completion of the ads, have students respond to the following questions in a reflection journal:

- Would you want this type of profession? Why or why not?
- What are the pros and cons of the job?
- What role does a second language play in this profession?

SUGGESTED LEARNING RESOURCES

¡Dime! Dos

Unidad 7, Lección 2
pp. 353, 363

¡Dime! Algo

Cuaderno de actividades
Unidad 4, Lección 2
¡A leer!
pp. 177–178

Recurso de profesor: Datos solamente

Imágenes de España

Capítulo 1
El crecimiento de la economía
pp. 11–13

Imágenes de América Latina

Capítulo 1
Unas economías en vías de desarrollo
pp. 12–13



Notes

STRATEGIES
YEAR 3





Strategies

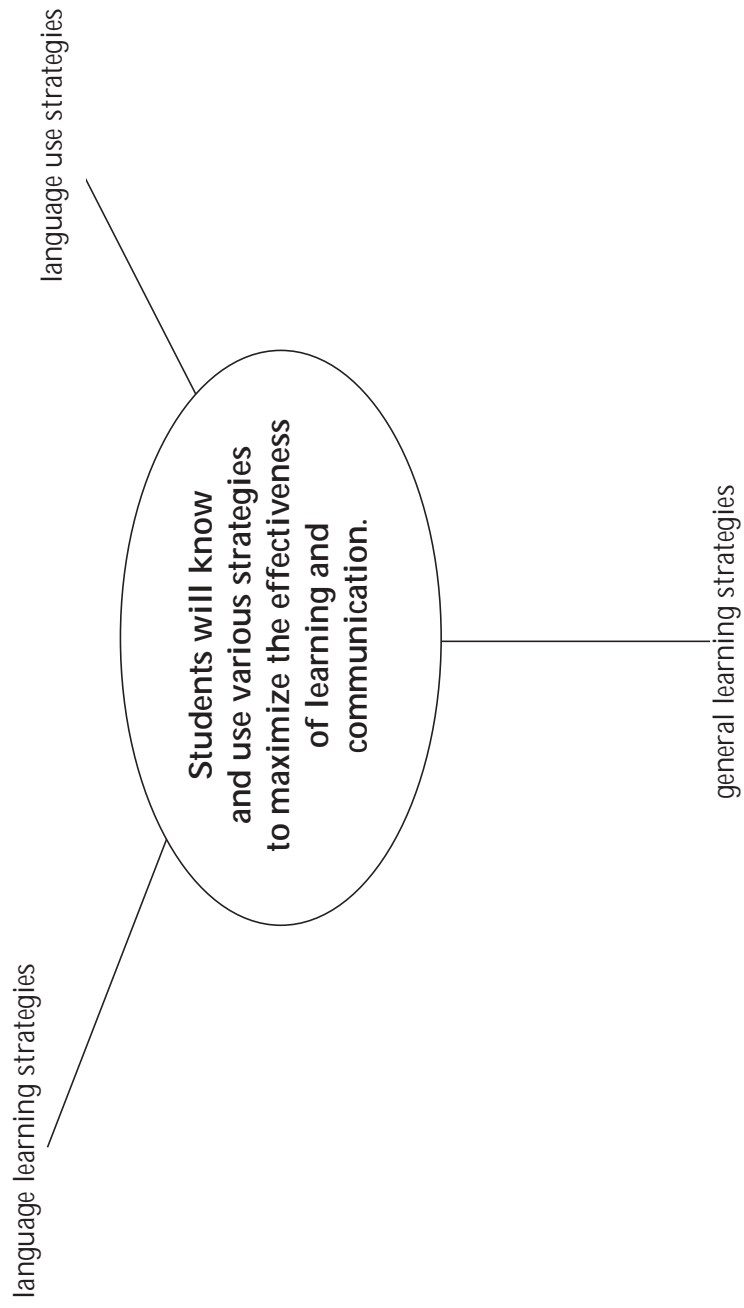



STRATEGIES

General Outcome 4: Students will know and use various strategies to maximize the effectiveness of learning and communication.

Under the Strategies heading are specific outcomes that will help students learn and communicate more effectively. Strategic competence has long been recognized as an important component of communicative competence. The outcomes that follow deal not only with compensation and repair strategies, important in the early stages of language learning when proficiency is low, but also with strategies for language learning, language use in a broad sense, as well as general learning strategies that help students acquire content. Although people may use strategies unconsciously, the outcomes deal only with the conscious use of strategies.

The strategies are grouped under three cluster headings—see the illustration on the preceding page. Under each of these headings there are several strands. Each strand deals with a specific category of strategy. Language learning and general learning strategies are categorized as cognitive, metacognitive, and social/affective. The language use strategies are organized by communicative mode: interactive, interpretive, and productive.

The strategies that students choose depend on the task they are engaged in as well as on other factors, such as their preferred learning style, personality, age, attitude, and cultural background. Strategies that work well for one person may not be effective for another person or may not be suitable in a different situation. For this reason it is not particularly useful to say that students should be aware of, or able to use, a specific strategy in a particular course. Consequently, the specific outcomes describe the students' knowledge of and ability to use general types of strategies. More specific strategies for each general category or type are included in the comprehensive list of strategies in Appendix E. The specific strategies provided in the comprehensive list are not prescriptive but are provided as an illustration of how the general strategies in the specific outcomes might be developed.

Teachers need to know and be able to demonstrate a broad range of strategies from which students are then able to choose in order to communicate effectively. Strategies of all kinds are best taught in the context of learning activities where students can apply them immediately and then reflect on their use.



PRESCRIBED OUTCOMES	SUGGESTIONS FOR INSTRUCTION
<p>General Outcome 4: Strategies Students will know and use various strategies to maximize the effectiveness of learning and communication.</p> <p>4.1 language learning strategies</p> <p>4.1.1 <i>Cognitive</i></p> <ul style="list-style-type: none">❖ identify and use a variety of cognitive strategies to enhance language learning (e.g., group together sets of things—vocabulary, structures—with similar characteristics, identify similarities and differences between aspects of Spanish and their own language)	<ul style="list-style-type: none">➤ Have students play VERBingo in order to better understand patterns in reflexive and other verbs. ➤ Divide students into two or three teams. Have each team stand in a line so that the first person is in front of the board. On the board, write all the pronoun subjects and a verb in the infinitive. Provide the first person in the line of each team with chalk or a marker. The first person in the line of each team runs to the board to conjugate the given verb with “yo,” runs back to his/her teammates and gives the marker to the next member on the team. This person runs to the board and conjugates the given verb with the subject “tú.” The game continues until the first team has completed the conjugation of the verb with all the subject pronouns. A point is awarded if the team correctly conjugates the verb.



SUGGESTIONS FOR ASSESSMENT

SUGGESTED LEARNING RESOURCES

- When students participate in games, look for evidence that they are able to
 - make connections between pictures and verb conjugations
 - listen actively to instructions
 - participate willingly and actively throughout game

Provide students with a test following the activity confirming their understanding of the verb conjugation patterns. Give unknown verbs that follow the same pattern to verify if students can apply the strategy.

- When students participate in a team verb conjugation game, look for evidence that students are able to
 - try conjugations individually first
 - solicit assistance from their team mates
 - identify mistakes
 - identify patterns in the verb conjugations

- Conference with students to review their ideas with them and to verify that they have an awareness of their learning, strengths, and weaknesses.

VERBingo



PRESCRIBED OUTCOMES	SUGGESTIONS FOR INSTRUCTION
<p>4.1 language learning strategies (continued)</p> <p>4.1.2 <i>Metacognitive</i></p> <ul style="list-style-type: none">❖ identify and use a variety of metacognitive strategies to enhance language learning (e.g., reflect on the listening, reading, and writing processes; check copied writing for accuracy) <p>4.1.3 <i>Social/Affective</i></p> <ul style="list-style-type: none">❖ identify and use a variety of social and affective strategies to enhance language learning (e.g., understand that making mistakes is a natural part of language learning, experiment with various forms of expression, note their acceptance or nonacceptance by more experienced speakers)	<ul style="list-style-type: none">➤ Post a simple text at the front of the room. Have students work in teams. Students take turns going to the front and reading a portion of the text, then returning to their team and reciting what they have read. A different team member records what has been recited after each portion. At the end of the text, a reporter is chosen to read what was recited and recorded by the group. Then provide students with the original text from the front of the room and have them compare it with their versions. Afterwards, discuss with students the different methods they used to remember the text.➤ At the beginning of the course or at the beginning of a unit, have students complete a survey asking them to identify some of their interests. This survey can be used to incorporate ideas and activities into the units planned throughout the course.➤ Throughout a unit, have students write a learning log that identifies the activities they liked best during the unit, what they feel they learned, and what they feel they still need to work on.➤ Before students prepare a poster about a particular disease, have them brainstorm and prepare a web as a pre-writing activity.



SUGGESTIONS FOR ASSESSMENT

SUGGESTED LEARNING RESOURCES

- Have students respond in a learning log to the following questions:
 - What methods did you use to remember the text?
 - What methods presented by other students would you try next time?

- Monitor students' logs throughout the year for evidence of the following:
 - regular use of log
 - continuity (Do students work on things they have previously identified?)
 - growth in the ability to reflect on their own needs and interests



PRESCRIBED OUTCOMES	SUGGESTIONS FOR INSTRUCTION
<p>4.2 language use strategies</p> <p>4.2.1 <i>Interactive</i></p> <ul style="list-style-type: none">❖ identify and use a variety of interactive strategies (e.g., assess feedback from a conversation partner to recognize when a message has not been understood) <p>4.2.2 <i>Interpretive</i></p> <ul style="list-style-type: none">❖ identify and use a variety of interpretive strategies (e.g., use knowledge of the sound-symbol system to aid reading comprehension) <p>4.2.3 <i>Productive</i></p> <ul style="list-style-type: none">❖ identify and use a variety of productive strategies (e.g., use knowledge of sentence patterns to form new sentences)	<p>➤ Have students form teams or small groups. Provide each group with several vocabulary words from themes studied. Ask a member of each team to describe the word. The other members of the team must guess what the word is, based on the description given. If the team guesses correctly, a point is awarded.</p> <p>➤ Instruct students to follow a procedure when they encounter unknown words:</p> <ol style="list-style-type: none">1. Read sentences before and after the unknown word.2. Find words or phrases that give clues to the word's meaning.3. Look at word parts (prefixes, suffixes, etc.).4. Think about words that are similar.5. Use a dictionary, glossary, etc. to verify meaning.6. Create a mental or visual picture to retain meaning. <p>➤ See <i>Ejemplo de un plan de búsqueda</i> (Year 3, pp. 85–86 or Planning, pp. 67–68).</p>



SUGGESTIONS FOR ASSESSMENT

SUGGESTED LEARNING RESOURCES

- As students work in teams to describe vocabulary words from themes studied, look for evidence that they are
 - speaking Spanish throughout activity
 - encouraging other team members
 - soliciting information from each other in a positive way

- Provide students with a checklist to monitor the extent to which they use an established procedure when encountering new words.

- When students are using an inquiry plan, look for evidence that they are able to
 - develop an inquiry plan
 - use it appropriately



PRESCRIBED OUTCOMES	SUGGESTIONS FOR INSTRUCTION
<p>4.3 general learning strategies</p> <p>4.3.1 <i>Cognitive</i></p> <ul style="list-style-type: none">❖ identify and use a variety of cognitive strategies to enhance general learning (e.g., write down key words and concepts in abbreviated form) <p>4.3.2 <i>Metacognitive</i></p> <ul style="list-style-type: none">❖ identify and use a variety of metacognitive strategies to enhance general learning (e.g., make a plan in advance about how to approach a task)	<p>➤ Provide students with language structures they are learning in Spanish and language structures in their first language. Have students match the Spanish structure with a corresponding structure in their first language. Then have students compare and contrast the structures in both languages. Finally, have students complete a text in Spanish in which they must use the Spanish structures studied in the matching activity.</p> <p>➤ Provide students with a list of choices/activities related to themes studied. Have students choose the type of activity they wish to complete in order to encourage learning based on individual learning styles (e.g., for the vacations theme, students might choose from the following types of activities: song, travel brochure, travel poster, promotional videoclip).</p> <p>Provide students with a reflections questionnaire. Questions might include the following:</p> <ul style="list-style-type: none">• Why and how did I choose my activity?• What did I understand about the work I did?• How did I relate what I already know with new information?• How have my ideas changed?• What did I not understand?• What questions do I still have?• How can I find the answers to my questions?



SUGGESTIONS FOR ASSESSMENT

- As students work with language structures in English and in Spanish, look for evidence they are able to
 - identify and compare patterns between the languages
 - use knowledge of two language structures in order to complete matching/fill in the blank activities correctly

- Collect students' reflection questionnaires and look for evidence that students respond thoughtfully and with appropriate detail.

SUGGESTED LEARNING RESOURCES

Side by Side, Spanish & English Grammar



PRESCRIBED OUTCOMES	SUGGESTIONS FOR INSTRUCTION
<p>4.3 general learning strategies (continued)</p> <p>4.3.3 <i>Social/Affective</i></p> <ul style="list-style-type: none">❖ identify and use a variety of social and affective strategies to enhance general learning (e.g., encourage themselves to try even though they might make mistakes)	<p>➤ Provide students with a procedure to support them in the group decision-making process/problem-solving process. A sample set of steps for group process problems/decisions follows (Manitoba Education and Training, <i>Grades 5 to 8 English Language Arts: A Foundation for Implementation</i>, Grade 5 – 430):</p> <ul style="list-style-type: none">• Define problem or task• Clarify ideas• Elaborate ideas• information• Brainstorm• Confirm ideas• Evaluate ideas• Find solutions



SUGGESTIONS FOR ASSESSMENT

SUGGESTED LEARNING RESOURCES

- Present students with a situation and have them work in groups, following the procedure discussed. Have students do a group evaluation after the activity in which they answer the following types of questions:
 - Did your group follow the steps? Why or why not?
 - Which activities were most useful? Less useful?
 - How did this procedure help you to come to a decision or solve a problem?



Notes

APPENDICES
YEAR 3

Appendix A

Cómo cooperamos en nuestro grupo de trabajo—Formulario A

Nombre _____ Fecha _____

Miembros del grupo _____

Piensa cómo se desempeñó tu grupo. Colorea la casilla apropiada.

1. Usamos el tiempo bien y nos ayudamos a mantenernos en la tarea.

SI EMPRE	A VECES	RARA VEZ	NUNCA
----------	---------	----------	-------

2. Escuchamos a cada uno.

SI EMPRE	A VECES	RARA VEZ	NUNCA
----------	---------	----------	-------

3. Nos motivamos.

SI EMPRE	A VECES	RARA VEZ	NUNCA
----------	---------	----------	-------

4. Contribuimos con nuestras ideas y opiniones.

SI EMPRE	A VECES	RARA VEZ	NUNCA
----------	---------	----------	-------

5. Ayudamos a todos los miembros del grupo a comprender la tarea.

SI EMPRE	A VECES	RARA VEZ	NUNCA
----------	---------	----------	-------

6. Compartimos la cantidad de trabajo.

SI EMPRE	A VECES	RARA VEZ	NUNCA
----------	---------	----------	-------

7. Nos ayudamos a concentrarnos en la tarea.

SI EMPRE	A VECES	RARA VEZ	NUNCA
----------	---------	----------	-------

Una dificultad que nuestro grupo tuvo fue

Para solucionar esta dificultad nosotros

Appendix B

¿Cómo fue el trabajo de mi grupo?

Nombre _____ Fecha _____

Miembros del grupo _____

Marca una Sí No

Aporté ideas.		
Escuché a otros.		
Hice preguntas.		
Motivé a otros.		
Discrepé cortésmente.		
Me mantuve en la tarea.		

En mi grupo, me fue muy bien en:

-
-
-
-

Mis objetivos para la próxima vez son:

-
-
-
-

Los pasos que debo seguir para alcanzar mis objetivos son:

-
-
-
-

Los recursos que necesito para lograr mis objetivos son:

-
-
-
-

Appendix C

Ejemplo de un plan de búsqueda

(Adapted from Linda Ross, as found in Manitoba Education and Training, *Grades 5 to 8 English Language Arts: A Foundation for Implementation*, Grade 8 – 184–185)

Nombre: _____ Fecha: _____

Etapa 1—Preparar un objetivo y un plan

Haz una lluvia de ideas e identifica algunos temas de investigación/búsqueda. Apunta tus ideas y preguntas de investigación aquí abajo.

Tema: _____

Conocimientos previos: ¿Qué sabes ya sobre este tema? Apunta lo que sabes en forma esquemática o en un organizador gráfico.

¿Qué quieres saber? Prepara preguntas relevantes sobre el tema para establecer un objetivo para tu búsqueda. Escribe tus preguntas aquí abajo.

Prepara y usa un plan.

Mi audiencia es

Mi resultado final será _____

Prepararé mis apuntes usando ... (Marca lo que usarás).

- | | | |
|--|--|---|
| <input type="checkbox"/> forma esquemática | <input type="checkbox"/> esquema | <input type="checkbox"/> Slim Jims |
| <input type="checkbox"/> tabla, gráfico | <input type="checkbox"/> organizador gráfico | <input type="checkbox"/> Web/internet/red |
| <input type="checkbox"/> Tabla SQA Plus* | <input type="checkbox"/> I-tabla | |

Etapa 2—Obtener información

Marca los recursos usados

- | | | | | |
|---|-------------------------------------|--------------------------------------|---|------------------------------------|
| <input type="checkbox"/> catálogos en línea | <input type="checkbox"/> periódicos | <input type="checkbox"/> entrevistas | <input type="checkbox"/> enciclopedias | <input type="checkbox"/> internet |
| <input type="checkbox"/> experimentos | <input type="checkbox"/> CD-Roms | <input type="checkbox"/> diagramas | <input type="checkbox"/> tablas, gráficos | <input type="checkbox"/> encuestas |
| <input type="checkbox"/> recursos humanos | <input type="checkbox"/> almanaques | <input type="checkbox"/> videos | <input type="checkbox"/> documentales | <input type="checkbox"/> foros |
| <input type="checkbox"/> biografías | <input type="checkbox"/> debates | <input type="checkbox"/> artefactos | <input type="checkbox"/> otros | |

* See Teaching and Learning, p. 59.

Mis referencias de información son:

Escribe: Nombre del autor, título de referencia, fecha de publicación, lugar de publicación y nombre del editor.

Recuerda lo siguiente:

- Evalúa la exactitud, la fluidez, utilidad, cantidad (suficiente) y fiabilidad de los materiales de referencia usados. Evalúa usando una lista de criterios preparada por la clase o por ti. Adjunta tu evaluación de información a este organizador.
- Prepara tus apuntes usando el método que indicaste en la Etapa 1. Adjunta tus apuntes a este organizador.

Revisa tus apuntes para determinar si la información en tus apuntes es actual, pertinente y completa. Haz las correcciones necesarias en tus apuntes.

Etapa 3—Información de proceso

Escribe tu borrador. Asegúrate de usar detalles para sustentar las ideas principales. Adjunta tu borrador a este plan.

- Revisa usando un color diferente para:
 - ◆ eliminar información no pertinente
 - ◆ indicar brechas en la información presentada
 - ◆ aclarar ideas e información
 - ◆ ordenar la secuencia de ideas e información
 - ◆ generar interés del lector: escribiendo frases de manera eficaz y que expresen claramente el contenido
- Corrige usando un color diferente para:
 - ◆ el uso apropiado de palabras de transición y de conectores
 - ◆ la ortografía exacta
 - ◆ la puntuación y el uso apropiado de la letra mayúscula
 - ◆ las oraciones completas
 - ◆ la variedad de frases
 - ◆ el vocabulario apropiado
 - ◆ la gramática: el tiempo verbal, sujeto/verbo y la concordancia del sustantivo/ pronombre personal, modificadores apropiados
 - ◆ el tono apropiado para la audiencia
- Primero, revisa y corrige tu trabajo. Luego, revísalo y corrígelo con un compañero o con un grupo. Finalmente, revísalo y corrígelo con tu profesor.

Etapa 4—Presentar el resultado final

Comparte el resultado final de tu búsqueda con tu audiencia.

Etapa 5—Autoevaluarse y Reflexionar

Piensa en lo que aprendiste durante este proceso de investigación. ¿Cómo te afectó? ¿Cuáles fueron tus habilidades durante esta búsqueda? Apúntalas. Prepara nuevos objetivos para tu próxima búsqueda. Escribe tus reflexiones aquí abajo.

YEAR 4

Applications	3
Language Competence	23
Global Citizenship	51
Strategies	69
Appendices	79

APPLICATIONS
YEAR 4



Applications

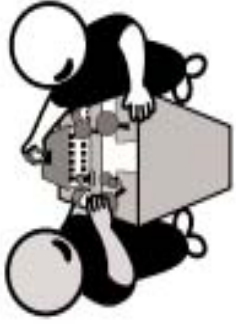

express emotions and personal perspectives

impart and receive information

get things done

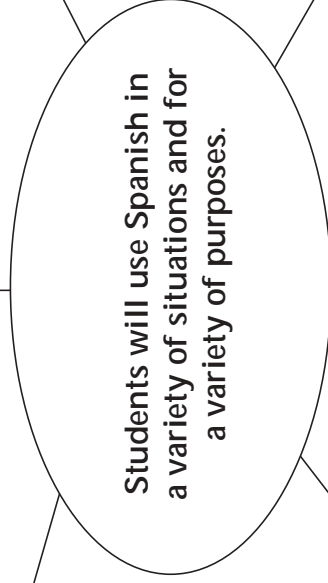

use the language for imaginative purposes and personal enjoyment

form, maintain, and change interpersonal relationships

extend their knowledge of the world



APPLICATIONS

General Outcome 1: Students will use Spanish in a variety of situations and for a variety of purposes.

The specific outcomes under the heading Applications deal with **what** the students will be able to do with the Spanish language, that is, the **functions** they will be able to perform and the **contexts** in which they will be able to operate. This functional competence, also called actional competence, is important for a content-based or task-based approach to language learning where students are constantly engaged in meaningful tasks (Celce-Murcia, Dörnyei, and Thurrell).

The functions are grouped under six cluster headings—see the illustration on the preceding page. Under each of these headings, there are one or more strands. Each strand deals with a specific language function (e.g., share factual information). Students at any grade level will be able to share factual information. Beginning learners will do this in very simple ways (e.g., “This is my dog.”). As students gain more knowledge and experience, they will broaden the range of subjects they can deal with, they will learn to share information in writing as well as orally, and they will be able to handle formal and informal situations.

Different models of communicative competence have organized language functions in a variety of ways. The organizational structure chosen here reflects the needs and interests of students in a classroom where activities are focused on meaning and are interactive. For example, the strand entitled **manage group actions** has been included to ensure that students acquire the language necessary to function independently in small groups, since this is an effective way of organizing second language classrooms. The strands under the cluster heading **to extend their knowledge of the world** will accommodate a content-based approach to language learning where students learn content from another subject area as they learn the Spanish language.

The level of linguistic, sociolinguistic, and discourse competence that students will exhibit when carrying out the functions is defined in the specific outcomes for Language Competence for each course. To know how well students will be able to perform the specific function, the Applications outcomes must be read in conjunction with the Language Competence outcomes.



PRESCRIBED OUTCOMES	SUGGESTIONS FOR INSTRUCTION
<p>General Outcome 1: Applications Students will use Spanish in a variety of situations and for a variety of purposes.</p> <p>1.1 impart and receive information</p> <p>1.1.1 <i>Share Factual Information</i></p> <ul style="list-style-type: none">❖ provide information on several aspects of a topic (e.g., give a simple report)❖ understand and use definitions, comparisons, examples	<p>➤ Have students research the life of a celebrity, artist, or musician, traditional or contemporary, of a Spanish-speaking country. Have students then present their findings to the class, without giving the name of the famous person. Classmates must guess who the person is. Have students use a biographical map to help them organize ideas:</p> <ul style="list-style-type: none">• Biography Title• Timelines or Milestones• Achievements• Personal Qualities• Important people in life <p>(BC <i>Resource Package</i>, 42; Manitoba Education and Training, <i>Grades 5 to 8 English Language Arts: A Foundation for Implementation</i>, Grade 5 – 354)</p> <p>➤ Ask students to explore various examples of people whose accomplishments they admire. List them on the board and discuss. Then have students think of events in their own lives of which they feel personally proud. Suggest that students prepare a presentation to the class describing their personal chosen event or accomplishment and explaining why it is important to them (e.g., how the student has changed as a result) (BC <i>Resource Package</i>, 60).</p>



SUGGESTIONS FOR ASSESSMENT

SUGGESTED LEARNING RESOURCES

- As students present information they have researched about a famous person of a Spanish-speaking country, look for evidence that they
 - present accurate and detailed information
 - show appreciation for the importance or relevance of the individual's contributions
 - avoid stereotyping or overgeneralizing (global citizenship, affirming diversity)
 - are developing increased understanding of and insights into Hispanic culture and society (global citizenship, affirming diversity)

- When students narrate events orally or in writing, provide prompts or questions to help them elaborate. Note the extent to which students
 - enhance their descriptions with details of time, place, and people involved
 - comment on circumstances surrounding events, as well as on the events themselves
 - use verb tenses appropriately to sequence events and differentiate between circumstances and isolated events (language competence, attend to form)
 - use appropriate verb tenses to differentiate between past and present (language competence, attend to form)
 - speak clearly, using pronunciation and intonation to support and convey meaning (language competence, attend to form)
 - describe and narrate events in comprehensible way (language competence, oral production)

¡Dime! Pasaporte al mundo 21
 Unidad 3, Lección 1
 Gente del Mundo
 pp. 121, 126, 127

¡En español! 2
 Unidad 2, Etapa 2

Imágenes de España
Imágenes de América Latina
 <www.buscabiografias.com>

¡Dime! Pasaporte al mundo 21
 Unidad 3, Lección 1
 Gente del Mundo,
 pp. 121, 126, 127

¡En español! 2
 Unidad 2, Etapa 2

Imágenes de España
Imágenes de América Latina
 <www.buscabiografias.com>



PRESCRIBED OUTCOMES	SUGGESTIONS FOR INSTRUCTION
<p>1.1 impart and receive information (continued)</p> <p>1.1.1 <i>Share Factual Information (continued)</i></p> <ul style="list-style-type: none">❖ provide information on several aspects of a topic (e.g., give a simple report)❖ understand and use definitions, comparisons, examples	<p>➤ Have students prepare a television or movie review, using the following guidelines:</p> <ol style="list-style-type: none">1. Tell the name of the movie or TV program.2. Tell the name of the characters in it.3. Tell what kind of show it is.4. Tell some interesting, funny, or exciting things that happened in it.5. Tell what you liked or did not like about it.6. Rate it from 1-5 (Top Rating) and explain your rating.7. Tell who you think would enjoy the show or movie and why you think they would enjoy it (Manitoba Education and Training, <i>Grades 5 to 8 English Language Arts: A Foundation for Implementation, Grade 5 – 28</i>).
<p>1.2 express emotions and personal perspectives</p> <p>1.2.1 <i>Share Ideas, Thoughts, Opinions, Preferences</i></p> <ul style="list-style-type: none">❖ inquire about and express agreement and disagreement, approval and disapproval, satisfaction and dissatisfaction, interest and lack of interest	<p>➤ Have students prepare surveys related to a theme studied (e.g., favourite entertainment figures, favourite types of music, hobbies, etc.).</p>



SUGGESTIONS FOR ASSESSMENT

SUGGESTED LEARNING RESOURCES

- When students prepare a TV or movie review, provide them with a checklist for self or peer assessment, based on the guidelines given for the review.

¡En español! 3
Unidad 6, Etapa 1

- Work with students to prepare assessment criteria for surveys. Criteria might include the following:
 - clear formulation of questions
 - questions are relevant to the chosen topic
 - use of varied and appropriate vocabulary (language competence, attend to form)
 - correct spelling (language competence, attend to form)
 - evidence of risk-taking by attempting to go beyond vocabulary and structures practised in class (strategies)

Internet
¡En español! 2
Etapa preliminar and
Unidad 1
Resource Book, p. 57
Survey



PRESCRIBED OUTCOMES	SUGGESTIONS FOR INSTRUCTION
<p>1.2 express emotions and personal perspectives (continued)</p> <p>1.2.1 <i>Share Ideas, Thoughts, Opinions, Preferences (continued)</i></p> <ul style="list-style-type: none">❖ inquire about and express agreement and disagreement, approval and disapproval, satisfaction and dissatisfaction, interest and lack of interest <p>1.2.2 <i>Share Emotions, Feelings</i></p> <ul style="list-style-type: none">❖ inquire about and express emotions and feelings in a variety of familiar contexts❖ compare the expression of emotions and feelings in a variety of informal situations	<p>➤ <i>Fortune Cookie Activity</i>—From a container, have students draw papers with their fortunes, in the style of the fortune cookie. Students must agree or disagree with the fortune they have drawn. As an extension, students could write a story related to the fortune they have drawn.</p> <p>➤ Have students write a poem regarding friendship, hobbies, etc., using a chart of emotions and corresponding faces as a guide. Each stanza of the poem would have one picture to represent it. Have students present their poems in small groups. Display poems in the classroom.</p> <p>➤ Have students prepare a number of role plays based on situations related to driving:</p> <ul style="list-style-type: none">• Getting a driver’s licence• Being stopped by a police officer• Getting permission to use the family car• Getting into an accident <p>Preparation of the role plays should focus on the emotions and feelings involved and the level of formality.</p>



SUGGESTIONS FOR ASSESSMENT

SUGGESTED LEARNING RESOURCES

- As students work in groups to discuss fortunes, look for evidence that students are able to
 - take turns to participate
 - clearly express their agreement or disagreement with fortune drawn
 - respond appropriately to questions and cues from others
 - speak Spanish throughout the activity

- Provide students with criteria for assessment of poem before students begin. Criteria might include the following:
 - appropriate selection from “emotions chart” to match the poem’s tone
 - poem should have two stanzas of four lines each (language competence, discourse)
 - appropriate use of vocabulary and expressions (language competence, attend to form)

- When students present the poem, look for evidence that they are able to
 - use body language and facial expression to convey the emotion of the poem (language competence, sociocultural context)
 - listen to peers attentively (strategies)
 - accept peer feedback (strategies)

- When students prepare role plays, look for evidence that they
 - effectively communicate the emotion/s
 - use appropriate level of formality for the context
 (See role-play assessment criteria in Classroom Assessment, p. 11.)

The Evolving Multicultural Classroom

Teacher’s Discovery
 <www.teachersdiscovery.com>
 A number of resources are available on this website that may be useful.

Planet@ 2
 pp. 60, 150

Teacher’s Discovery
 <www.teachersdiscovery.com>
 A number of resources are available on this website that may be useful.



SUGGESTIONS FOR ASSESSMENT

- Discuss criteria with students before they prepare role play situations. The teacher may wish to develop a checklist students can use for self and peer assessment. Criteria might include the following:
 - level of formality is appropriate for the context
 - meaning is clear
 - appropriate details are included in questions and answers

Language Competence Criteria:

 - gestures and body language support communication
 - pronunciation and intonation are generally accurate
 - interaction has some sense of fluency and spontaneity
 - props and visual aids are used to support communication

(See role-play assessment criteria in Classroom Assessment, p. 11.)

- As students interact to complete a seven day agenda of activities, look for evidence that they are able to
 - invite/accept/decline using patterns and structures learned
 - speak Spanish throughout the activity
 - interact with a variety of peers throughout the activity

SUGGESTED LEARNING RESOURCES

¡Dime! Más
Unidad 5, Lección 2

Para jugar. Juegos comunicativos.
Español lengua extranjera.

¡Dime! Uno
Unidad 3

Planet@ 1
Tema 4

Chicos Chicas, Nivel 1
Unidad 3, Lección 5



PRESCRIBED OUTCOMES	SUGGESTIONS FOR INSTRUCTION
<p>1.3 get things done (continued)</p> <p>1.3.3 <i>Manage Group Actions</i></p> <ul style="list-style-type: none">❖ check for agreement and understanding❖ express disagreement in an appropriate way❖ express appreciation, enthusiasm, support, and respect for contributions of others	<p>➤ With a partner or in groups, have students create a children’s game and determine the rules and procedures. Through the creation process, students agree or disagree with the set rules and procedures. Each group then explains the game to the class. The class can then suggest a modification or change to the rules.</p> <p><i>Extension activity:</i> The students can present their game to another audience.</p>
<p>1.4 extend their knowledge of the world</p> <p>1.4.1 <i>Discover and Explore</i></p> <ul style="list-style-type: none">❖ ask questions to gain knowledge and clarify understanding❖ explore meaning in a variety of ways (e.g., by drawing a diagram, making a model, rephrasing)	<p>➤ Provide a variety of contemporary and traditional music and visual art from the Spanish-speaking world. Ask students to illustrate their personal responses to these works by creating a poster, collage, or magazine cover that represents three different songs, musicians, or artists the students particularly enjoyed. Students could include captions that reflect their thoughts and feelings about these works (BC <i>Resource Package</i>, 40).</p>



SUGGESTIONS FOR ASSESSMENT

- As students explain the rules of a simple game, look for evidence that they are able to
 - express agreement and disagreement
 - play the game/rules of game are clear
 - speak Spanish throughout the presentation
 - use the imperative with "tú" correctly (language competence, attend to form)
 - use appropriate vocabulary to explain game (language competence, attend to form)

- As students plan the presentation of a game to another class or to elementary students, provide students with criteria before they begin. Criteria might include the following:
 - appropriate choice of game for audience
 - correct use of imperative with "tú"
 - clear and simple instructions
 - good effort to interact and invite participation

- Look at the posters, collages, or magazine covers that students create in response to creative works for evidence that they are able to offer unique personal perspectives or impressions combining visual elements and words.

SUGGESTED LEARNING RESOURCES

- ¡En español! 2*
Unidad 2, Etapa 1
- ¡Buen Viaje! 2*
Capítulo 5
- ¡Viva el español!: ¡Hola!*
Resource and Activity Book
Culture Resource Book
- ¡Viva el español!: ¿Qué Tal?*
Resource and Activity Book
Culture Resource Book
- ¡Viva el español!: ¡Adelante!*
Resource and Activity Book
Culture Resource Book
-
- ¡Buen Viaje! 2*
Capítulo 13, Conexiones
- ¡En español! 3*
Unidad 5, Etapa 1
- Teaching Spanish through Music
<www.caslt.org/research/musicsp.htm>
- ¡Dime! Pasaporte al mundo 21*
Unidad 2, Lección 2
pp. 90, 91, 102–105
- ¡Buen Viaje! 2*
Capítulo 13
pp. 390, 391



PRESCRIBED OUTCOMES	SUGGESTIONS FOR INSTRUCTION
<p>1.4 extend their knowledge of the world (continued)</p> <p>1.4.2 <i>Gather and Organize Information</i></p> <ul style="list-style-type: none">❖ gather information from a variety of resources (e.g., print, human, multimedia)❖ organize and manipulate information (e.g., transform information from texts into other forms, such as tables, diagrams, story maps)	<p>➤ Brainstorm with students about what they know about fairytales. Have students put information into a web. Present students with a fairytale. Have students complete the following chart after reading the fairytale.</p> <ul style="list-style-type: none">• Setting• Characters• Problem• Magic• Events• Ending <p>As an extension, have students write their own version of the original fairytale studied. Have students then compare the original version with another student's version.</p>
<p>1.4.3 <i>Solve Problems</i></p> <ul style="list-style-type: none">❖ describe and analyze a problem, then propose solutions❖ generate and evaluate alternative solutions to problems	<p>➤ Use the topic of driving to identify a problem and solve in small groups (e.g., car sharing, infringing upon rules re driving).</p> <p>➤ Have students identify problems that are evident in current events and have them consider possible solutions.</p>



SUGGESTIONS FOR ASSESSMENT	SUGGESTED LEARNING RESOURCES
<p>➤ As students brainstorm and create webs, look for evidence that they are able to</p> <ul style="list-style-type: none"> • identify key ideas • organize categories • draw from past experiences • take risks putting forward their ideas • ask questions to clarify information <p>➤ As students examine fairytales, look for evidence that they are able to</p> <ul style="list-style-type: none"> • identify the main characteristics of fairytales • identify similarities and differences in different versions of a fairytale 	<p><i>Planet@ 1</i> Tema 5</p> <p>Hadaluna Lee <http://pagina.de/hadaluna></p> <p>Imaginaria—Revista de Literatura Infantil y Juvenil <www.imaginaria.com.ar/> <www.sedl.org/loteced/scenarios/spanish_legends.html></p> <p><i>Planet@ 2</i> Tema 1: Recuerda</p>
<p>➤ As students work in groups to identify a problem and consider solutions, look for evidence that students are able to</p> <ul style="list-style-type: none"> • state and describe the problem • list possible solutions • use target vocabulary and expressions (language competence, attend to form) • speak Spanish during group activity 	<p><i>¡Buen Viaje! 2</i> Capítulo 11</p> <p><i>Planet@ 1</i> p. 114</p> <p><i>Planet@ 1</i> p. 131, #4 Modify accordingly</p>



PRESCRIBED OUTCOMES	SUGGESTIONS FOR INSTRUCTION
<p>1.4 extend their knowledge of the world (continued)</p> <p>1.4.4 <i>Explore Opinions and Values</i></p> <ul style="list-style-type: none">❖ explore how values influence behaviour (e.g., describe characters and their motivations in a story)❖ provide reasons for their position on an issue	<ul style="list-style-type: none">➤ Have students choose a character from a fairytale. Students then examine an issue or another character from this character's point of view➤ Have students tell a traditional fairytale from the point of view of a different character (e.g., Red Riding Hood as told by the wolf).
<p>1.5 imaginative purposes and personal enjoyment</p> <p>1.5.1 <i>Humour/Fun</i></p> <ul style="list-style-type: none">❖ participate in class excursions, field trips, or twinning projects❖ interpret songs and stories	<ul style="list-style-type: none">➤ Provide students with comic strips with the conversation in the bubbles whited out. Students complete the comic strips with their own versions of the conversation.➤ Provides students with one part of comic strip. Each student must find the other half of his/her comic strip by checking with classmates. When students have found their partner with the other half of the comic strip, have them role play the scene for the class or create an alternative dialogue.
<p>1.5.2 <i>Creative/Aesthetic Purposes</i></p> <ul style="list-style-type: none">❖ use the language creatively and for aesthetic purposes (e.g., experiment with the sounds and rhythms of the language)	<ul style="list-style-type: none">➤ Have students impersonate a famous artist, designer, poet, or musician. Students must explain how the famous person created his/her work of art. This may be created by the students or researched before presentation.➤ Have students impersonate a character within a painting by a Spanish-speaking artist that they have viewed. Invite students to explain what they are doing in the painting and what is happening.



SUGGESTIONS FOR ASSESSMENT

SUGGESTED LEARNING RESOURCES

- As students examine an issue from a particular character's point of view, look for evidence that they are able to
 - take risks putting forward their ideas
 - state opinions clearly
 - include details, reasons, and examples to support opinions
 - use a range of appropriate vocabulary and structures (language competence, attend to form)
 - adjust language to reflect the perspective of the chosen character

- As students complete comic strips with their own versions of the conversation, look for evidence that they are able to
 - use language in humorous ways
 - take risks to go beyond vocabulary and structures learned in class

- Discuss criteria for the impersonation of a famous artist, designer, poet, musician, or character within a painting. Criteria might include the following:
 - relevant information is provided
 - pronunciation and intonation are generally accurate (language competence, attend to form)
 - props and visual aids are used to support communication (language competence, representation)

Hadaluna Lee
 <www.andaluciaglobal.com>

Imaginaria—Revista de Literatura Infantil y Juvenil
 <www.imaginaria.com.ar/>

<www.sedl.org/loteced/scenarios/spanish_legends.html>

<www.turning-pages.com/mafalda/mafaldaes.htm>

<www.quino.com.ar>

Gessler Publishing Co. Inc.
 New York
 Garfield Comic

Ediciones de la Flor S.R.L.
 Colombia
 Mafalda

¡En español! 2
 Unidad 4, Etapa 1
 p. 264 (Review)

¡En español! 3
 Unidad 1, Etapa 3, p. 92 (El legendario rey del mambo)

¡Dime! Pasaporte al mundo 21
 Sección: Gente del mundo
 Ventanas al mundo



PRESCRIBED OUTCOMES	SUGGESTIONS FOR INSTRUCTION
<p>1.5 imaginative purposes and personal enjoyment (continued)</p> <p>1.5.3 <i>Personal Enjoyment</i></p> <ul style="list-style-type: none">❖ use the language for personal enjoyment (e.g., find a personal pen pal and exchange letters)	<ul style="list-style-type: none">➤ Invite students to work in groups to choose their favourite selections from a variety of CDs in Spanish and put together music awards ceremonies for the class. Ask groups to select categories (e.g., “best male singer,” “best group,” etc.) and present nominations and winners in Spanish, giving as much background information as possible (BC <i>Resource Package</i>, 56).
<p>1.6 form, maintain, and change interpersonal relationships</p> <p>1.6.1 <i>Manage Personal Relationships</i></p> <ul style="list-style-type: none">❖ initiate and participate in casual exchanges with classmates❖ use routine means of interpersonal communications (e.g., telephone calls, personal notes, email messages)	<ul style="list-style-type: none">➤ Have students prepare a profile of themselves in order to solicit a pen pal. Have students include name, age, physical/personal traits, favourite pastimes, and hobbies. Send profiles via mail or email to another Spanish class and have students continue exchange of information throughout the course.



SUGGESTIONS FOR ASSESSMENT

SUGGESTED LEARNING RESOURCES

- Observe that students are participating actively.

- Have students participate in a peer writing assessment activity after completing the tasks. Adapt the Peer Writing Assessment found on page Year 4 – 83.



Notes

*LANGUAGE
COMPETENCE
YEAR 4*



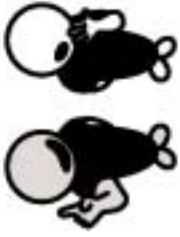

Language Competence

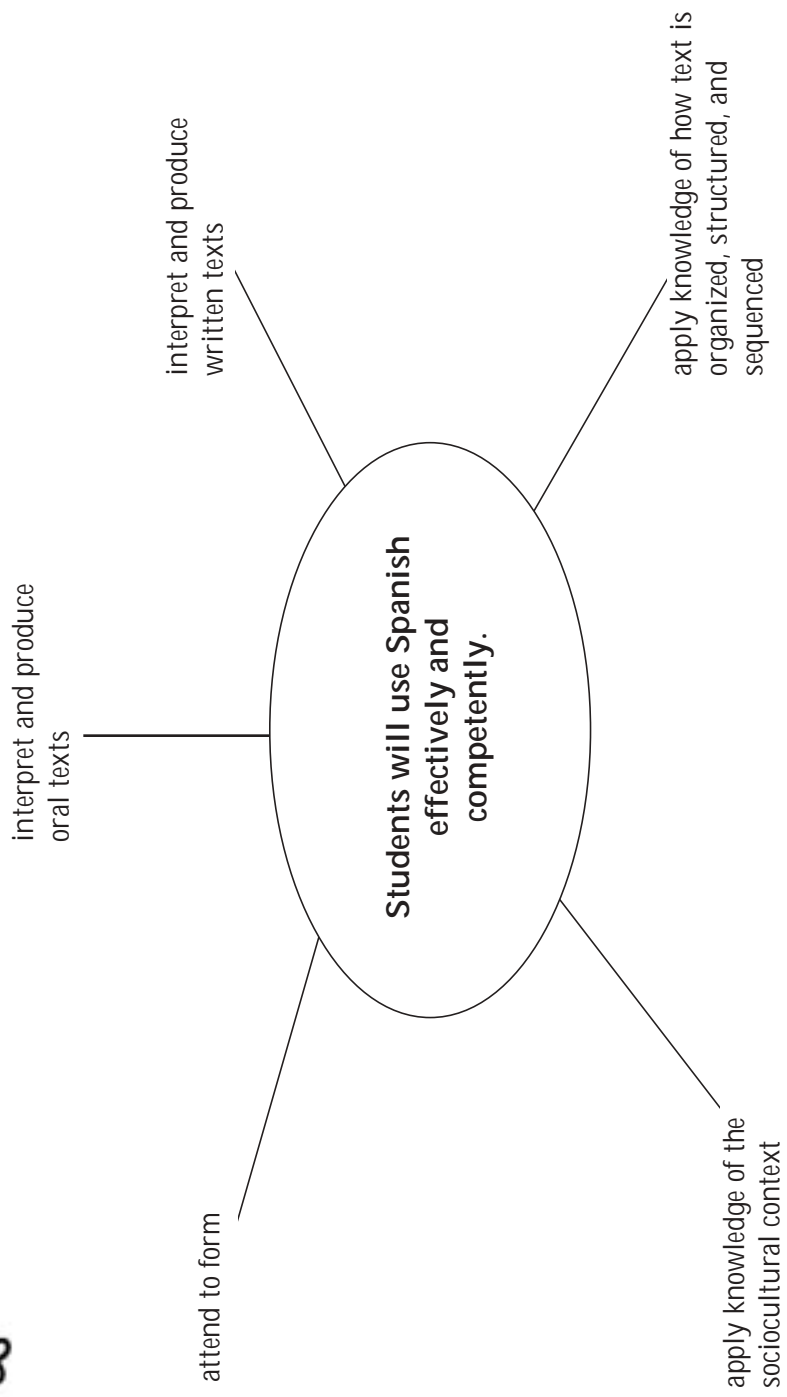



LANGUAGE COMPETENCE

General Outcome 2: Students will use Spanish effectively and competently.

Language competence is a broad term that includes linguistic or grammatical competence, discourse competence, sociolinguistic or sociocultural competence, and what might be called textual competence. The specific outcomes under Language Competence deal with knowledge of the Spanish language and the ability to use that knowledge to interpret and produce meaningful texts appropriate to the situation in which they are used. Language competence is best developed in the context of activities or tasks where the language is used for real purposes, in other words, in practical **applications**.

The various components of language competence are grouped under four cluster headings—see the illustration on the preceding page. Under each of these headings there are several strands. Each strand deals with a single aspect of language competence. For example, under the cluster heading **attend to form**, there is a strand for phonology (pronunciation, stress, intonation), orthography (spelling, mechanical features), lexicon (vocabulary words and phrases), and grammatical elements (syntax and morphology).

Although the outcomes isolate these individual aspects, language competence should be developed through learning activities that focus on meaningful uses of the Spanish language and on **language in context**. Tasks will be chosen based on the needs, interests, and experiences of students. The vocabulary, grammar structures, text forms, and social conventions necessary to carry out a task will be taught, practised, and assessed as students are involved in various aspects of the task itself, **not in isolation**.

Strategic competence is often closely associated with language competence, since students need to learn ways to compensate for low proficiency in the early stages of learning if they are to engage in authentic language use from the beginning. This component is included in the language use strategies in the Strategies section.



PRESCRIBED OUTCOMES	SUGGESTIONS FOR INSTRUCTION
<p>General Outcome 2: Language Competence Students will use Spanish effectively and competently.</p> <p>2.1 attend to form</p> <p>2.1.1 <i>Phonology</i></p> <ul style="list-style-type: none">❖ identify and reproduce some critical sound distinctions that are important for meaning <p>2.1.2 <i>Orthography</i></p> <ul style="list-style-type: none">❖ apply some common spelling rules❖ consistently use basic spelling patterns in writing familiar words and phrases	<ul style="list-style-type: none">➤ When preparing a fashion show, ask students to prepare short texts to present the models and/or clothing they are wearing, using correct stress and intonation patterns of the Spanish language. ➤ Provide students with opportunities to self and peer edit written work in order to verify basic rules and mechanical conventions.



SUGGESTIONS FOR ASSESSMENT

**SUGGESTED LEARNING
RESOURCES**

- Look for evidence that students spell target vocabulary accurately in a variety of situations.

Colección tiempo: Para pronunciar
Rosetta Stone I and II



PRESCRIBED OUTCOMES
<p>2.1 attend to form (continued)</p> <p>2.1.3 <i>Lexicon</i></p> <ul style="list-style-type: none">❖ use a repertoire of words and phrases in familiar contexts that meet the needs and interests of students, particularly within the following areas of experience:<ul style="list-style-type: none">— arts and entertainment<ul style="list-style-type: none">✓ music— relationships<ul style="list-style-type: none">✓ friends✓ clubs✓ activities✓ sports✓ hobbies— celebration<ul style="list-style-type: none">✓ cultural— fashions and fads— driving— folk tales/legends— daily routines❖ recognize that one word may have multiple meanings, depending on the context, and that various words and expressions may express the same idea

SUGGESTIONS FOR INSTRUCTION



SUGGESTIONS FOR ASSESSMENT

**SUGGESTED LEARNING
RESOURCES**

USO interactivo del vocabulario

Rosetta Stone I and II



PRESCRIBED OUTCOMES	SUGGESTIONS FOR INSTRUCTION
<p>2.1 attend to form (continued)</p> <p>2.1.4 <i>Grammatical Elements</i></p> <ul style="list-style-type: none">❖ use, in modelled situations, the following grammatical elements:<ul style="list-style-type: none">— possessive pronouns: <i>mío, tuyo, suyo, míos, tuyos, suyos</i>— indirect object pronouns— double object pronouns— impersonal verb form with <i>se</i>— preterite tense (irregular verbs)— preterite vs. imperfect tense— comparative, superlative, and diminutive	<p>Modelled Situations: This term is used to describe learning situations where a model of specific grammatical elements is consistently provided and immediately available. Students in such situations will have an emerging awareness of the grammatical elements and be able to apply them in very limited situations. Limited fluency and confidence characterize student language.</p> <p>Example of a modelled situation:</p> <p>In preparation for a group project, students will keep a journal of their daily activities for a week. Students practise the structure “<i>tener que + infinitive</i>” using the sentence patterns provided. Each student asks five classmates, <i>¿Qué tienes que hacer después de clases hoy?</i> Students answer saying, <i>Tengo que . . .</i>, with an infinitive of their choice. Each person then summarizes the results of their mini survey, <i>Tres estudiantes tienen que estudiar</i>, and so on.</p>



SUGGESTIONS FOR ASSESSMENT

**SUGGESTED LEARNING
RESOURCES**

*USO de la gramática española: Junior
intermedio*

Rosetta Stone I and II



PRESCRIBED OUTCOMES	SUGGESTIONS FOR INSTRUCTION
<p>2.1 attend to form (continued)</p> <p>2.1.4 <i>Grammatical Elements (continued)</i></p> <ul style="list-style-type: none">❖ use, in structured situations, the following grammatical elements:<ul style="list-style-type: none">— commands—negative forms— commands—irregular verbs (<i>tú</i> form)— stem-changing verbs in the present tense— irregular verbs: <i>dar, poner, traer</i>— preterite tense (regular verbs)— perfect tense— direct object pronouns— reflexive verbs	<p>Structured Situations: This term is used to describe learning situations where a familiar context for the use of specific grammatical elements is provided and students are guided in their use. Students in such situations will have increased awareness and emerging control of the grammatical elements and be able to apply them in familiar contexts with teacher guidance. Student language is characterized by increasing fluency and confidence.</p> <p>Example of a structured situation:</p> <p>In preparation for a research project on typical activities of young people in selected Spanish-speaking countries, students listen to a rapid conversation where a Canadian student is talking to an exchange student from Mexico. The students check off, on a prepared answer sheet, what the exchange student does and does not do.</p>



SUGGESTIONS FOR ASSESSMENT

**SUGGESTED LEARNING
RESOURCES**

SUGGESTIONS FOR ASSESSMENT	SUGGESTED LEARNING RESOURCES



PRESCRIBED OUTCOMES	SUGGESTIONS FOR INSTRUCTION
<p>2.1 attend to form (continued)</p> <p>2.1.4 <i>Grammatical Elements (continued)</i></p> <ul style="list-style-type: none">❖ use, in independent situations, the following grammatical elements:<ul style="list-style-type: none">— <i>nos/les (os), gusta/gustan</i>— possessive adjectives and pronouns: <i>nuestro/a/os/as, vuestro/a/os/as</i>— irregular verbs: <i>poder, conocer, saber, venir, salir, decir, hacer, preferir</i>— commands—regular verbs (<i>tú</i> form)— commands for commonly used verbs (e.g., <i>usted, ustedes</i>)— present progressive (<i>estar + gerund</i>)	<p>Independent Situations: This term is used to describe learning situations where students use specific grammatical elements in a variety of contexts with limited teacher guidance. Students in such situations will have consistent control of the grammatical elements and be able to apply them in a variety of contexts with limited teacher guidance. Fluency and confidence characterize student language.</p> <p>Example of an independent situation: Students send a letter, an email message, or a recorded message to a Spanish-speaking pen pal explaining what they do regularly.</p>



SUGGESTIONS FOR ASSESSMENT

**SUGGESTED LEARNING
RESOURCES**

USO de la gramática española

Rosetta Stone I and II



SUGGESTIONS FOR ASSESSMENT

SUGGESTED LEARNING RESOURCES

- When students prepare a skit of the middle portion of a fable, discuss criteria before students begin. Criteria might include the following:
 - meaning is clear
 - events are sequenced to create a coherent story
 - appropriate conventions and traditions are incorporated
 - interesting and relevant details are incorporated
 - gestures and body language support communication (language competence, non-verbal communication)
 - pronunciation and intonation are generally accurate (language competence, attend to form)

- When students prepare a fashion show on a particular theme, discuss criteria before students begin. Criteria might include the following:
 - appropriate vocabulary related to clothing and fashion is used
 - present progressive and present tense are used appropriately (*ella está llevando*, etc.) (language competence, attend to form)
 - comparative is used appropriately (language competence, attend to form)
 - pronunciation and intonation are generally accurate (language competence, attend to form)
 - props are used to support the presentation

Fábulas de Esopo
 en Educación y Desarrollo
 para Todos
 <[www.edyd.com/fabulas/
 esopa](http://www.edyd.com/fabulas/esopa)>

¡Dime! Dos
 In each unit, sección:
 Para Empezar

¡En español! 2
 Unidad 4, Etapa 3
 Vocabulary and Ideas,
 not subjunctive

¡Buen Viaje! 2
 Capítulo 4, pp. 86–89
 Vocabulary



PRESCRIBED OUTCOMES	SUGGESTIONS FOR INSTRUCTION
<p>2.2 interpret and produce oral texts (continued)</p> <p>2.2.3 <i>Interactive Fluency</i></p> <ul style="list-style-type: none">❖ manage short interactions with ease, with pauses for planning and repair	<ul style="list-style-type: none">➤ After students have examined several advertisements for movies, have them role-play planning to attend one. Their choices should reflect the information acquired from the advertisements (e.g., movie titles, locations, times, actors, critic's ratings, etc.). Students might also refer to their favourite genres (BC <i>Resource Package</i>, 46). Alternatively, students could work in groups in which each person presents a movie he/she has seen, with discussion following.
<p>2.3 interpret and produce written texts</p> <p>2.3.1 <i>Written Interpretation</i></p> <ul style="list-style-type: none">❖ understand short texts on unfamiliar topics in guided situations	<ul style="list-style-type: none">➤ Have students read a fairytale or fable. Have them develop a semantic map or web to identify the main and supporting details.



PRESCRIBED OUTCOMES	SUGGESTIONS FOR INSTRUCTION
<p>2.3 interpret and produce written texts (continued)</p> <p>2.3.2 <i>Written Production</i></p> <ul style="list-style-type: none">❖ produce short, simple texts in guided and unguided situations <p>2.3.3 <i>Visual Interpretation</i></p> <ul style="list-style-type: none">❖ derive meaning from multiple visual elements in a variety of media in guided situations	<ul style="list-style-type: none">➤ Have students write a fan letter to an entertainer, singer, musician, etc.➤ Have students write their own simple fairytale or have them rewrite a common fairytale in modern setting. Provide students with a story writing planner to help organize their ideas. Story models should also be provided or discussed prior to this activity.➤ Show students several music videos from Spanish-speaking countries and ask them to note titles of songs, names of artists, personal preferences, and other relevant information. Have students create promotional posters for their favourite videos or DVDs. Using the posters as props, students could then role-play a panel of critics discussing the music (BC <i>Resource Package</i>, 56).➤ Have students watch a Spanish music video without the sound. Then ask students to read the lyrics of two different songs. Students try to determine which lyrics would best match the scene presented in the video. Watch the music video again, with the song audible to the students. Discuss which are the correct lyrics and whether or not they feel the scene for the music video is appropriate for the lyrics.➤ Show students a program similar to <i>Fashion File</i>. As students view, have them note preferences in style, colours of the season, etc. Have students also examine the message that the program is trying to convey. After viewing, have students work in groups to discuss their observations and compare what they viewed to current teen fashion.



SUGGESTIONS FOR ASSESSMENT

SUGGESTED LEARNING RESOURCES

- When students write their own fairytale, provide them with writing self and peer assessment tools as well as a writing planner to help them organize their ideas. Use these tools as a basis for final assessment.

(See example of story assessments in Classroom Assessment, pp. 18–19.)
- Discuss criteria for posters before students begin. Criteria might include the following:
 - artist’s name and song title are clear
 - visual interpretation, vocabulary, and expressions are appropriate
- As students watch a Spanish music video and attempt to interpret the lyrics, look for evidence that they are able to
 - listen attentively
 - interpret images to match lyrics
- As students view a fashion program and then discuss in groups, look for evidence that they
 - make relevant comments
 - use varied and appropriate vocabulary
 - express personal opinions clearly

Local Spanish TV Channels

Local Spanish TV Channels

¡Buen Viaje! 2
pp. 86, 89



PRESCRIBED OUTCOMES	SUGGESTIONS FOR INSTRUCTION
<p>2.3 interpret and produce written texts (continued)</p> <p>2.3.4 <i>Representation</i></p> <ul style="list-style-type: none">❖ express meaning through the use of multiple visual elements in a variety of media in guided situations	<ul style="list-style-type: none">➤ After students have become familiar with the storyline of a fairytale with large illustrations and simple text, have them each create a poster promoting the book, using visual information and some key Spanish words.➤ Have students listen to a Spanish song, read a poem, or watch a video. Then form small groups and invite them to create banners or posters to represent their interpretations of the work presented. As an extension activity, ask the groups to come up with possible titles for their works (BC <i>Resource Package</i>, 16). Provide students with the lyrics to the songs.➤ Present a Spanish song or video and invite each student to create a CD cover or video case to promote it. Display and discuss students' work in class (BC <i>Resource Package</i>, 40).
<p>2.4 apply knowledge of the sociocultural context</p> <p>2.4.1 <i>Register</i></p> <ul style="list-style-type: none">❖ identify socially appropriate language in specific situations❖ explore formal and informal uses of language in a variety of contexts <p>2.4.2 <i>Idiomatic Expressions</i></p> <ul style="list-style-type: none">❖ use learned idiomatic expressions in a variety of contexts	<ul style="list-style-type: none">➤ Have students role-play a situation in which a police officer stops a driver for speeding and focus on the use of the formal register. Then have students develop a role-play in which they are describing the experience of being stopped by the police to a friend. Have students focus on the informal register in this dialogue.➤ Provide students with idiomatic expressions in context. Have students guess what they think they mean. Then provide the actual meanings. Have students then choose one or two idiomatic expressions and represent them visually.



SUGGESTIONS FOR ASSESSMENT	SUGGESTED LEARNING RESOURCES
<ul style="list-style-type: none"> ➤ When students create banners or posters based on creative works they have experienced, note evidence that they are <ul style="list-style-type: none"> • offering personal views or responses • using their knowledge about Spanish works to create something new • incorporating some of the features they have seen in Spanish works • interested in the traditions involved ➤ When students create CD covers or video cases, ask each student to decide on three or four criteria to use for self and peer assessment. Provide opportunities to hear others' ideas before making the final selection of criteria. 	<p><i>¡Dime! Dos</i> Unidad 6, Lección 3 pp. 327–329</p> <p><i>¡Buen Viaje! 2</i> Literatura: La Muralla pp. 436, 437</p> <p><i>Ventanas tres</i></p> <p><i>Planet@ 2</i> Tema 5 p. 131</p>
<ul style="list-style-type: none"> ➤ When students prepare role plays using the formal and informal registers, note the extent to which they are able to <ul style="list-style-type: none"> • use formal and informal register in the appropriate situations • provide clear messages • use intonation, gestures, and body language to support communication • speak clearly and smoothly, with pronunciation being generally accurate 	
<ul style="list-style-type: none"> ➤ When students represent idiomatic expressions visually, look for evidence that <ul style="list-style-type: none"> • the representation corresponds with the idiomatic expression • the representation expresses the main idea of the idiomatic expression 	<p><i>101 Spanish Idioms</i></p> <p><i>2001 Spanish and English Idioms</i></p>



PRESCRIBED OUTCOMES	SUGGESTIONS FOR INSTRUCTION
<p>2.4 apply knowledge of the sociocultural context (continued)</p> <p>2.4.3 <i>Variations in Language</i></p> <ul style="list-style-type: none">❖ recognize influences resulting in variations in language (e.g., age, social class, geographical region) <p>2.4.4 <i>Social Conventions</i></p> <ul style="list-style-type: none">❖ explore and identify variations in social conventions (e.g., regional, situational) <p>2.4.5 <i>Non-verbal Communication</i></p> <ul style="list-style-type: none">❖ interpret and use appropriate non-verbal behaviours in a variety of familiar contexts	<ul style="list-style-type: none">➤ Provide students with teenage slang. Have students use the expressions in a dialogue related to a theme studied (e.g., relationships, entertainment). Alternatively, have students view a segment of a TV show or movie and have them note expressions.➤ Discuss with students variations in social conventions according to age. How do young people act during specific cultural celebrations compared to their parents? Their grandparents? Watch a Spanish TV or movie segment and identify social conventions for young people in the segment.➤ Brainstorm with students several ways in which we communicate non-verbally in North American culture. Then present students with common gestures from Spanish-speaking countries, using drawings to support gestures. As an extension, students could work in groups to prepare a scenario in which one or more of the gestures would be used.



SUGGESTIONS FOR ASSESSMENT

SUGGESTED LEARNING RESOURCES

- As students examine teen slang and social conventions for young people, look for evidence that they are able to identify variations related to age.

Paso a Paso 2
 La Catrina
¡Buen Viaje! 3
 Video
 La boda cubana
 La quinceañera

- Look for evidence that students are able to
 - identify gestures and interpret the meaning when viewing texts
 - use gestures in role plays

Diccionario de gestos



PRESCRIBED OUTCOMES	SUGGESTIONS FOR INSTRUCTION
<p>2.5 apply knowledge of how text is organized, structured, and sequenced</p> <p>2.5.1 <i>Cohesion/Coherence</i></p> <ul style="list-style-type: none">❖ organize texts, using common patterns (e.g., cause and effect, straightforward time sequencing, steps in a procedure)❖ interpret simple references within texts (e.g., pronouns, demonstratives) <p>2.5.2 <i>Text Forms</i></p> <ul style="list-style-type: none">❖ recognize and use a variety of text forms delivered through a variety of media (e.g., videotaped instructions, reports with visuals)❖ analyze and identify the organizational structure of a variety of text forms (e.g., folk tales/fables, newspaper articles, instructions for a game)	<p>➤ Provide students with a form letter as a model for writing a fan letter to a musician, entertainer, actor, etc.</p> <p>➤ Provide students with a cloze activity, using a letter. Have students complete the letter, looking for references.</p> <p>➤ Have students complete a concept overview to identify the key characteristics of fairytales and fables. A sample concept overview could include the following (Manitoba Education and Training, <i>Grades 5 to 8 English Language Arts: A Foundation for Implementation</i>, Grade 5 – 128):</p> <ul style="list-style-type: none">• Key word or concept• Write an explanation or definition in your own words.• Draw a figurative representation.• List 5 facts/characteristics• Write down two questions about the concept. <p>➤ Have students work in groups to examine different sections of the newspaper (e.g., entertainment, sports, fashion). Have students analyze the organization, content, and vocabulary. Students then choose one section and create their own mini-newspaper. Magazines could be used instead of newspapers for this activity.</p>



SUGGESTIONS FOR ASSESSMENT	SUGGESTED LEARNING RESOURCES
<p>➤ Work with students to develop a simple checklist they can use for self and peer assessment of a fan letter. The checklist might include items such as the following:</p> <ul style="list-style-type: none"> • meaning is clear • interesting details are included • questions are appropriate and polite • greeting and closing are appropriate • punctuation is appropriate • spelling, including accents, is correct 	<p><i>Dos Mundos</i> Student Edition</p>
<p>➤ Work with students to develop appropriate criteria for the preparation of a mini-newspaper or magazine. Criteria might include the following:</p> <ul style="list-style-type: none"> • organization and layout is appropriate for a newspaper or magazine • information provided is relevant • interesting details are provided • vocabulary is used which is relevant for section of newspaper or magazine chosen 	<p><i>¡En español! 2</i> Unidad 1, Etapa 3 Video: En contexto En vivo</p>



PRESCRIBED OUTCOMES	SUGGESTIONS FOR INSTRUCTION
<p data-bbox="103 281 561 386">2.5 apply knowledge of how text is organized, structured, and sequenced (continued)</p> <p data-bbox="103 407 526 441"><i>2.5.3 Patterns of Social Interaction</i></p> <ul data-bbox="175 462 542 638" style="list-style-type: none">❖ initiate interactions, and respond using a variety of social interaction patterns (e.g., routine telephone calls)	<ul data-bbox="607 533 1403 827" style="list-style-type: none">➤ Using situations related to driving, provide students with a social interaction pattern:<ul data-bbox="656 617 1321 827" style="list-style-type: none">• Request to use family car• Request granted—Thanks• Request denied—repeated requests with reasons• Request granted—Thanks• Request denied again—Anger expressed



SUGGESTIONS FOR ASSESSMENT

**SUGGESTED LEARNING
RESOURCES**

- When students prepare role plays, using specific social interactions, look for evidence that they are able to combine simple social interaction patterns.



Notes

*GLOBAL
CITIZENSHIP
YEAR 4*



Global Citizenship



study historical and contemporary elements of Spanish-speaking cultures

affirm diversity

Students will acquire the knowledge, skills, and attitudes to be effective global citizens, through the exploration of the cultures of the Spanish-speaking world.

explore personal and career opportunities



GLOBAL CITIZENSHIP

General Outcome 3: Students will acquire the knowledge, skills, and attitudes to be effective global citizens, through the exploration of the cultures of the Spanish-speaking world.

The outcomes for Global Citizenship deal with a broad range of knowledge, skills, and attitudes needed to be effective global citizens—in other words, with the development of intercultural competence. The concept of global citizenship encompasses citizenship at all levels, from the local school and community to Canada and the world.

The various components of global citizenship are grouped under three cluster headings—see the illustration on the preceding page. Under each of these headings there are several strands. Each strand deals with a single aspect of intercultural competence. For example, under the cluster heading **study historical and contemporary elements of Spanish-speaking cultures**, there are strands for the processes and methods of acquiring knowledge about Spanish-speaking cultures, the cultural knowledge thus acquired, applications of that knowledge to aid comprehension and to communicate in appropriate ways, positive attitudes toward Spanish-speaking cultures, as well as knowledge of the diversity within those cultures.

Developing cultural knowledge and skills is a lifelong process. Knowledge of one's own culture is acquired over a lifetime. Cultures change over time. Within any national group, there may be a dominant culture or cultures and a number of minority cultures. Rather than try to develop an extensive bank of knowledge about the Spanish-speaking cultures, it is more important for students to learn the processes and methods of accessing and analyzing cultural practices. Students will gain cultural knowledge in the process of developing these skills. In this way, if they encounter elements of the Spanish-speaking cultures they have not learned about in class, they will have the skills and abilities to deal with them effectively and appropriately.

The **affirm diversity** heading covers knowledge, skills, and attitudes that are developed as a result of bringing other languages and cultures into relationship with one's own. There is a natural tendency, when learning a new language and culture, to compare it with what is familiar. Many students leave a second language learning experience with a heightened awareness and knowledge of their own language and culture. They will also be able to make some generalizations about languages and cultures based on their experiences and those of their classmates who may have a variety of cultural backgrounds. This will provide students with an understanding of diversity within both a global and a Canadian context.



PRESCRIBED OUTCOMES	SUGGESTIONS FOR INSTRUCTION
<p>General Outcome 3: Global Citizenship</p> <p>Students will acquire the knowledge, skills, and attitudes to be effective global citizens through the exploration of the cultures of the Spanish-speaking world.</p> <p>3.1 study historical and contemporary elements of Spanish-speaking cultures</p> <p>3.1.1 <i>Access/Analyze Cultural Knowledge</i></p> <ul style="list-style-type: none">❖ formulate questions about elements of Spanish-speaking cultures (e.g., patterns of behaviour or interaction typical of people their own age)❖ use basic research skills to find out about Spanish-speaking cultures	<p>➤ Present a demonstration or video of a dance style from a Spanish-speaking culture (e.g., tango, merengue, salsa, cumbia, flamenco). Invite students to participate by trying a few basic steps. Then ask them to list their favourite dance styles and add these to a class chart (<i>BC Resource Package</i>, 16).</p> <p>➤ Have students view a series of videos or DVDs about cultural celebrations in Spanish-speaking countries. Students choose one of the celebrations and prepare a "Special Occasion/Celebration Web" ("<i>Página web de una ocasión/celebración especial</i>"). The web consists of the main ideas presented in the video or DVD represented within an illustration that symbolizes an aspect of the celebration.</p> <p>➤ Have students examine relationships and dating in Latin America. Have students view a Spanish telenovela and discuss what they found in relationship patterns, roles, and communication. Then have students compare and contrast this with Canadian relationship values and patterns. Students could then prepare two short scenes for a soap opera, one that would illustrate relationships in Latin America and the other which would illustrate relationships in Canada.</p>



SUGGESTIONS FOR ASSESSMENT	SUGGESTED LEARNING RESOURCES
<p>➤ As students watch and then participate in Spanish dances, look for evidence that they</p> <ul style="list-style-type: none"> • are taking risks to dance and participate • show openness and interest • are able to identify some traditional Spanish dances <p>➤ As students prepare a Special Occasion Web, look for evidence that</p> <ul style="list-style-type: none"> • the main aspects of the celebration are represented • the illustration corresponds with an important aspect of the celebration • appropriate vocabulary is used 	<p><i>¡Buen Viaje! 3</i> Capítulo 3 Video Activities Tango</p> <p><i>¡Buen Viaje! 2</i> Capítulo 13</p> <p><i>¡Buen Viaje! 3</i> Capítulo 4 Video Activities La quinceañera, La boda cubana</p> <p><i>¡Dime! Uno</i> Unidad 4, Lección 1, 2, 3 El cumpleaños, La boda</p>
<p>➤ As students examine relationships and dating, look for evidence that they</p> <ul style="list-style-type: none"> • present views clearly • present relevant details about relationship patterns in Spanish-speaking countries and Canada • draw on their own experiences and observations • try to identify stereotypes 	<p><i>Paso a Paso 2</i> La Catrina video series</p>



PRESCRIBED OUTCOMES	SUGGESTIONS FOR INSTRUCTION
<p>3.1 study historical and contemporary elements of Spanish-speaking cultures (continued)</p> <p>3.1.1 <i>Access/Analyze Cultural Knowledge</i></p> <ul style="list-style-type: none">❖ formulate questions about elements of Spanish-speaking cultures (e.g., patterns of behaviour or interaction typical of people their own age)❖ use basic research skills to find out about Spanish-speaking cultures <p>3.1.2 <i>Knowledge of Spanish-Speaking Cultures</i></p> <ul style="list-style-type: none">❖ explore and identify some elements of Spanish-speaking cultures (e.g., key historical events and their influence on contemporary ways of life and cultural values)	<p>➤ Provide students with a text on the celebration of <i>Carnaval</i> in Latin America. Discuss the text with students and then have them work in groups of three in order to research <i>Carnaval</i> in a specific Hispanic country. Have students prepare a poster which depicts the main aspects of the celebration of carnival in the Hispanic country they have chosen.</p> <p>➤ Have students prepare a list of questions/hypotheses about Spanish-speaking cultures. Then have students use a variety of resources such as the Internet, Hispanic associations, books, etc. in order to test their hypotheses (e.g., “Are Peruvians more nationalistic than Canadians?”—Students might examine the way in which Independence Day is celebrated and compare/contrast to Canadian way of celebrating Canada Day.).</p>



SUGGESTIONS FOR ASSESSMENT

- Discuss criteria for the poster and presentation of the poster describing *Carnaval* in a Spanish-speaking country. Criteria might include the following:
 - main ideas are clearly represented
 - key words and phrases are included as labels
 - good use of space/layout
 - presentation of poster is organized, accurate, creative
 - pronunciation and intonation is generally accurate throughout presentation

(See poster assessment in Planning, p. 86.)

- When students make and test hypotheses about Spanish-speaking cultures, look for evidence that they
 - take risks to express opinions
 - are willing to research to test the hypotheses
 - provide accurate and relevant information
 - are sensitive to differences among Spanish-speaking cultures
 - show increasing awareness of differences in the Spanish-speaking world
 - use a variety of resources
 - use sources of information from within the culture

SUGGESTED LEARNING RESOURCES

TECLA—Birkbeck
 College and the Consejería de Educación of the Spanish Embassy in London
www.sgi.mec.es/uk/pub/tecla.html/
 “Los carnavales”—edición de Marzo, 2000
 “El Carnaval”—edición de 1 de marzo 1999

¡Buen Viaje! 3
 Capítulo 3 and Video Carnaval de Oruro

¡Dime! Pasaporte al mundo 21
 Unidad 1, Lección 2
 p. 49
 El Desfile puertorriqueño de Nueva York

¡Buen Viaje! 2
 Capítulo 13



PRESCRIBED OUTCOMES	SUGGESTIONS FOR INSTRUCTION
<p>3.1 study historical and contemporary elements of Spanish-speaking cultures (continued)</p> <p>3.1.3 <i>Apply Cultural Knowledge</i></p> <ul style="list-style-type: none">❖ apply knowledge of elements of Spanish-speaking cultures to interpret cultural behaviour that is different from their own❖ apply knowledge of elements of Spanish-speaking cultures in interactions with people and texts (e.g., interpret historical references) <p>3.1.4 <i>Diversity of Spanish-Speaking Cultures</i></p> <ul style="list-style-type: none">❖ apply knowledge of diverse elements of Spanish-speaking cultures in interactions with people and text (e.g., ethnic or religious minorities) <p>3.1.5 <i>Value Spanish-Speaking Cultures</i></p> <ul style="list-style-type: none">❖ express empathy for those whose cultural behaviour is different from their own❖ choose to participate in and contribute to activities and experiences that reflect Spanish-speaking cultures	<p>➤ Have students use their understanding of relationships when communicating with penpals.</p> <p>➤ Provide students with a calendar from a Spanish-speaking country. Have students examine it and identify holidays and other important dates. Students then compare holiday patterns and dates with those on a Canadian calendar. Discuss with students how the calendar year affects daily life. Have students incorporate discussion of an important holiday into a letter or email with a penpal or have a member of the Spanish-speaking community discuss a particular celebration with the class.</p> <p>➤ Invite a community member of Spanish-language heritage to speak to the class about his or her culture and its contributions to Canada. Before the visit, encourage students to prepare questions for the guest.</p>



SUGGESTIONS FOR ASSESSMENT

SUGGESTED LEARNING RESOURCES

- Look for evidence that students are able to
 - apply knowledge of Hispanic holidays to letter or email to penpal
 - apply knowledge of Hispanic holidays in the preparation of questions for guest speaker

- Provide prompts to encourage students to reflect upon what they have learned about contributions of Spanish-speaking cultures to our global society. Prompts could include the following:
 - Three things I have learned are _____
 - The contribution that I admire most is _____ because _____
 - I still am not clear about _____



PRESCRIBED OUTCOMES	SUGGESTIONS FOR INSTRUCTION
<p>3.2 affirm diversity</p> <p>3.2.1 <i>Awareness of First Language</i></p> <ul style="list-style-type: none">❖ identify some regional variations in their first language <p>3.2.2 <i>General Language Knowledge</i></p> <ul style="list-style-type: none">❖ recognize that languages may have regional differences in pronunciation, vocabulary, or structure	<ul style="list-style-type: none">➤ Have students examine how gender is reflected in the Spanish and English languages. Have students work in groups to discuss similarities and differences of gender roles. Discuss with students how language evolves to reflect changes in people’s attitudes and compare English and Spanish (e.g., English tends to look for a gender neutral term like “police officer” to replace a masculine term like “policeman”. Romance languages tend to use both masculine and feminine terms.). ➤ Have students listen to contemporary Latin rock. Have students study the lyrics and identify words that have been borrowed from English or have them look for Spanish words that English has borrowed (e.g., fiesta, taco, etc.). ➤ Distribute two copies of a short text, one text in old Spanish and the other in modern Spanish. Have students compare the texts and the Spanish used. Have them identify the differences and discuss how the language has evolved.



SUGGESTIONS FOR ASSESSMENT

- When students examine gender roles in language, look for evidence that they
 - are able to identify similarities and differences between Spanish and English
 - are able to relate differences to the nature of the language
 - express their views clearly and accurately on how gender is used
 - contribute to the discussion

- When students analyze the use of Spanish or English words in the lyrics of songs, look for evidence that they are able to
 - identify relevant examples of words borrowed from English or Spanish
 - give hypotheses for the reasons why these words have been borrowed

- When students analyze texts in old and modern Spanish, look for evidence that they are able to
 - identify some key differences between the two versions
 - give hypotheses about the evolution of the language

SUGGESTED LEARNING RESOURCES

TECLA—Birkbeck College and the Consejería de Educación of the Spanish Embassy in London
 <www.sgci.mec.es/uk/pub/tecla.html>
 “Uso no sexista del lenguaje”
 Edición de 28 de octubre 1996

Local Spanish TV Channels

¡Dime! Pasaporte al mundo 21
 Unidad 2, Lección 1
 pp. 83–88



PRESCRIBED
OUTCOMES

3.2 affirm diversity (continued)

3.2.3 Awareness of Own Culture

- ❖ identify some influences on the development of their personal identity
- ❖ identify shared references and the different connotations attached to them in their own culture and Spanish-speaking cultures

SUGGESTIONS FOR INSTRUCTION

- After students have viewed videos about Spanish holidays and celebrations, form groups and have each group complete a Venn diagram showing similarities and differences between these celebrations and Canadian ones. As an extension activity, students could create illustrated calendars indicating holidays and Santos days significant in the Spanish-speaking world (BC *Resource Package*, 18).

*Los feriados que
yo celebro*

*Los feriados que
se celebran en el
mundo de habla hispana*

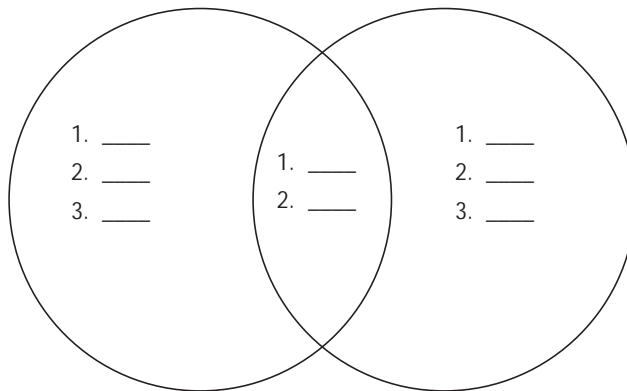

As a class, discuss important celebrations of the Spanish-speaking world (e.g., *Semana Santa*, *el Día de los muertos*, *Navidad*, *Carnaval*). Invite each student to choose one of these celebrations for in-depth study and give a presentation to the class, noting differences and similarities between it and the student's own cultural celebrations (BC *Resource Package*, 58).



SUGGESTIONS FOR ASSESSMENT

- When students draw comparisons based on their understanding of celebrations in the Spanish-speaking world, look for evidence that
 - the information is accurate and relevant
 - relevant details and examples are included to illustrate key points

Provide prompts such as the following to encourage students to reflect on what they have learned about culture:

- Three features that seem common to many cultures are _____
- Something that often varies among different cultures is _____
- Two views I have that are strongly influenced by my culture are _____

SUGGESTED LEARNING RESOURCES

- ¡Buen Viaje! 3*
Capítulo 4
Video Activities
La quinceañera, La boda cubana
- ¡Dime! Uno*
Unidad 4, Lección 1, 2, 3
El cumpleaños, La boda
- ¡Buen Viaje! 2*
- ¡En español! 3*
Unidad 3, Etapa 2
El año Nuevo



PRESCRIBED OUTCOMES	SUGGESTIONS FOR INSTRUCTION
<p>3.2 affirm diversity (continued)</p> <p>3.2.4 <i>General Cultural Knowledge</i></p> <ul style="list-style-type: none">❖ recognize that within any culture there are important differences in the way people speak and behave❖ recognize some of the factors that affect the culture of a particular region <p>3.2.5 <i>Value Diversity</i></p> <ul style="list-style-type: none">❖ demonstrate curiosity about other languages and cultures❖ recognize and acknowledge different perspectives	<p>➤ Have students view a movie set in a Spanish-speaking country in the 1800s to 1950s. Have students first note individually what they feel has changed or is different from modern society. Have students then work in pairs or in small groups to discuss the changes and why they feel these changes have occurred (e.g., <i>Zorro</i>, <i>Don Quixote</i>).</p> <p>➤ As an alternative, students view two contemporary movies set in different Spanish-speaking countries or regions. Have students identify differences in the language spoken in each country or region featured in the movies and the possible reasons for those differences.</p> <p>➤ Using the entertainment theme, have students examine how technology has influenced the way in which people entertain themselves.</p> <p>➤ Have students use the Internet, magazines, or newspapers to find two articles on a cultural topic (e.g., bullfights, violence in sports/soccer, sexism in fashion and advertisements, American influence on music and fashion, etc.). Have students identify the main opinions expressed in the articles (Manitoba Education and Training, <i>Success for All Learners</i>, 6.115). Then have students choose the position that they favour and explain the reasons for their positions. This could be done in the form of an oral presentation or in written form.</p>



PRESCRIBED OUTCOMES	SUGGESTIONS FOR INSTRUCTION
<p>3.2 affirm diversity (continued)</p> <p>3.2.6 <i>Intercultural Skills</i></p> <ul style="list-style-type: none">❖ explore representations of their own culture as seen from the outside❖ identify and make use of public and private institutions that facilitate contact with other countries and cultures	<ul style="list-style-type: none">➤ Have students work in groups. One or two groups design a brochure for exchange students from Hispanic countries. Information could include what they need to know about Western Canada and young people here. Another group designs a corresponding brochure for host families and students here.
<p>3.3 personal and career opportunities</p> <p>3.3.1 <i>Spanish Language and Spanish-Speaking Cultures</i></p> <ul style="list-style-type: none">❖ identify aspects of the history, literature, arts and crafts of Spanish-speaking cultures that are of personal interest❖ identify some careers that require or would value a knowledge of Spanish and Spanish-speaking cultures	<ul style="list-style-type: none">➤ Have students choose a career that they are interested in. Students then use the Internet and newspapers to do a search of this career. Based on information found, have students determine whether or not knowledge of Spanish, Spanish-speaking cultures, or knowledge of additional languages could be applied. Students then work in groups or as a whole class to list all careers in which knowledge of Spanish or another language would be useful.
<p>3.3.2 <i>Cultural and Linguistic Diversity</i></p> <ul style="list-style-type: none">❖ identify aspects of the history, literature, arts, and crafts of different cultures that are of personal interest❖ identify some careers that use knowledge of international languages and cultures, and intercultural skills	<ul style="list-style-type: none">➤ Have students research which countries offer bursaries for students to study in their country. Have students share their findings and choose the country where they would be most interested in studying.



SUGGESTIONS FOR ASSESSMENT

- When students design a brochure for exchange students and host families and students, develop criteria that students can use to guide their work. For example, to what extent does the brochure demonstrate
 - accurate and detailed information about Canada or about a specific province, according to the sections outlined
 - awareness of cultural differences that might affect relationships
 - appropriate vocabulary and structures (including verb tenses) (language competence, attend to form)
 - good organization and a clear layout

- When students search for information about careers in which knowledge of Spanish or another language could be applied, look for evidence that they
 - use a variety of sources to find career information
 - find and record relevant details
 - participate in class and group discussions in which career options are discussed

SUGGESTED LEARNING RESOURCES

¡En español! 2
 Unidad 6, Etapa 1
 Video: En contexto

¡Dime! Dos
 Unidad 7, Lección 2, 3

¡Buen Viaje! 2
 Capítulo 14
 pp. 398–405
 pp. 412–415

Internet



Notes

STRATEGIES
YEAR 4





Strategies

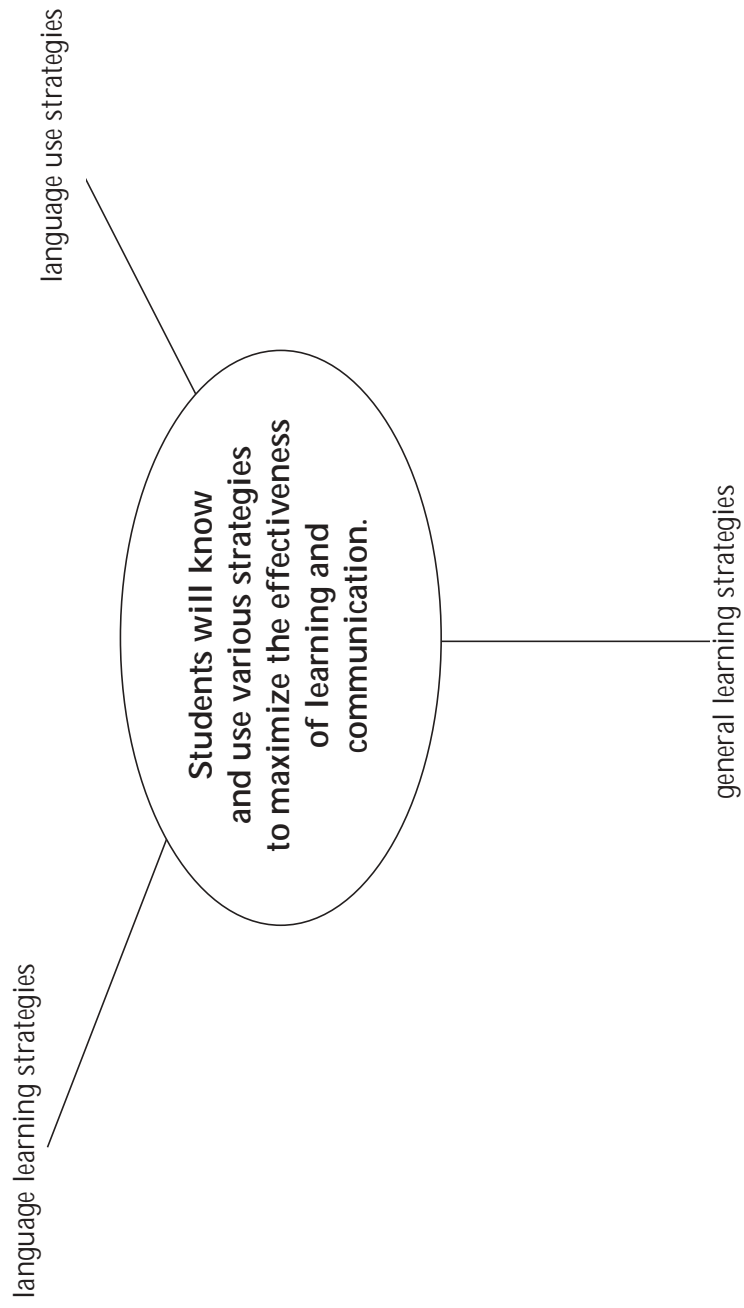



STRATEGIES

General Outcome 4: Students will know and use various strategies to maximize the effectiveness of learning and communication.

Under the Strategies heading are specific outcomes that will help students learn and communicate more effectively. Strategic competence has long been recognized as an important component of communicative competence. The outcomes that follow deal not only with compensation and repair strategies, important in the early stages of language learning when proficiency is low, but also with strategies for language learning, language use in a broad sense, as well as general learning strategies that help students acquire content. Although people may use strategies unconsciously, the outcomes deal only with the conscious use of strategies.

The strategies are grouped under three cluster headings—see the illustration on the preceding page. Under each of these headings there are several strands. Each strand deals with a specific category of strategy. Language learning and general learning strategies are categorized as cognitive, metacognitive, and social/affective. The language use strategies are organized by communicative mode: interactive, interpretive, and productive.

The strategies that students choose depend on the task they are engaged in as well as on other factors, such as their preferred learning style, personality, age, attitude, and cultural background. Strategies that work well for one person may not be effective for another person or may not be suitable in a different situation. For this reason it is not particularly useful to say that students should be aware of, or able to use, a specific strategy in a particular course. Consequently, the specific outcomes describe the students' knowledge of and ability to use general types of strategies. More specific strategies for each general category or type are included in the comprehensive list of strategies in Appendix E. The specific strategies provided in the comprehensive list are not prescriptive but are provided as an illustration of how the general strategies in the specific outcomes might be developed.

Teachers need to know and be able to demonstrate a broad range of strategies from which students are then able to choose in order to communicate effectively. Strategies of all kinds are best taught in the context of learning activities where students can apply them immediately and then reflect on their use.



PRESCRIBED OUTCOMES	SUGGESTIONS FOR INSTRUCTION
<p>General Outcome 4: Strategies Students will know and use various strategies to maximize the effectiveness of learning and communication.</p> <p>4.1 language learning strategies</p> <p>4.1.1 <i>Cognitive</i></p> <ul style="list-style-type: none">❖ select and use a variety of cognitive strategies to enhance language learning (e.g., associate new words or expressions with familiar ones, either in Spanish or in their own language) <p>4.1.2 <i>Metacognitive</i></p> <ul style="list-style-type: none">❖ select and use a variety of metacognitive strategies to enhance language learning (e.g., evaluate their own performance or comprehension at the end of a task, keep a learning log) <p>4.1.3 <i>Social/Affective</i></p> <ul style="list-style-type: none">❖ select and use a variety of social and affective strategies to enhance language learning (e.g., use self-talk to make themselves feel competent to do the task)	<p>➤ Have students work in groups and provide each group with a fable. Within the fable, highlight words they do not know and have groups find synonyms for the selected words.</p> <p>➤ Have students keep a learning log to reflect on their learning.</p> <p>➤ Using a text, model strategies to students re: comprehension of text. After the modelling of the metacognitive strategies, discuss with students what they observed. Provide a second text to students and have them use one or more strategies to create meaning from the text.</p> <p>➤ Have students use self-talk in order to help them prepare and feel competent to do a task.</p>



SUGGESTIONS FOR ASSESSMENT

SUGGESTED LEARNING RESOURCES

- As students work to find synonyms for selected words within a fable, look for evidence that they are able to
 - associate new words with familiar words
 - take risks to guess meanings
 - use resources to find definitions and appropriate synonyms

- Have students reflect on what they are learning. Possible questions to which they might respond include the following:
 - Which strategies were presented?
 - Which of the strategies presented did you recognize or have you used before?
 - Why do you think these strategies work for you?
 - Which strategies will be most helpful to you?

- As students prepare a task, provide opportunities for them to reflect on the task and how they will best be successful. Questions might include the following:
 - What is my role and what do I need to do to complete the task?
 - What are the obstacles I need to overcome and how can I overcome them?
 - Who can I ask to help me accomplish my task? How can that person help me?

Fábulas de Esopo

<www.edyd.com/fabulas/esopo>

<www.gate.com/ruhig/esopo.html>

Success for all Learners

Learning Log, pp. 6.56, 6.57

Senior 2 Spanish: A Course for Distance Learning, 1997

Introducción

Guía para el estudiante,

Estrategias para la lectura



PRESCRIBED OUTCOMES	SUGGESTIONS FOR INSTRUCTION
<p>4.2 language use strategies</p> <p>4.2.1 <i>Interactive</i></p> <ul style="list-style-type: none">❖ select and use a variety of interactive strategies (e.g., invite others into the discussion, ask for confirmation that a form used is correct) <p>4.2.2 <i>Interpretive</i></p> <ul style="list-style-type: none">❖ select and use a variety of interpretive strategies (e.g., prepare questions or a guide to note down information found in a text) <p>4.2.3 <i>Productive</i></p> <ul style="list-style-type: none">❖ select and use a variety of productive strategies (e.g., use resources to increase vocabulary)	<ul style="list-style-type: none">➤ During games and activities, have groups invite others to participate in the game. The organizers of the game present the rules, then have participants confirm their understanding of the rules. Allow students the opportunity to engage in the game.➤ Prior to preparing a poster for <i>Carnaval</i> in Latin America, have students use webs, charts, graphic organizers, etc. to note down and organize information found through texts during their research.➤ When students are doing research projects and are able to gather information from Spanish language resources, encourage them to use these resources to develop key vocabulary related to the topic. Students can then use this vocabulary to produce their own texts.



SUGGESTIONS FOR ASSESSMENT	SUGGESTED LEARNING RESOURCES
<p>➤ As students participate in interactive activities, look for evidence that they are able to</p> <ul style="list-style-type: none"> • confirm their understanding of the game/activity • participate actively with others • participate fairly by following rules <p>➤ When students prepare charts, webs, graphic organizers, etc., look for evidence that they are able to</p> <ul style="list-style-type: none"> • organize ideas into logical categories • make logical connections • ask relevant questions • use appropriate vocabulary • better understand the text because of graphic organizer <p>➤ As students participate in productive activities for specific communicative situations, look for evidence that they are able to</p> <ul style="list-style-type: none"> • use the new vocabulary found in resources • organize information • create something new, rather than replicating 	<p><i>¡En español! 2</i> Unidad 2, Etapa 1</p> <p><i>¡Buen Viaje! 2</i> Capítulo 5 pp. 124–127 pp. 142–143</p> <p>Internet</p>



PRESCRIBED OUTCOMES	SUGGESTIONS FOR INSTRUCTION
<p>4.3 general learning strategies</p> <p>4.3.1 <i>Cognitive</i></p> <ul style="list-style-type: none">❖ select and use a variety of cognitive strategies to enhance general learning (e.g., use mental images to remember new information) <p>4.3.2 <i>Metacognitive</i></p> <ul style="list-style-type: none">❖ select and use a variety of metacognitive strategies to enhance general learning (e.g., manage the physical environment in which they have to work) <p>4.3.3 <i>Social/Affective</i></p> <ul style="list-style-type: none">❖ select and use a variety of social and affective strategies to enhance general learning (e.g., use support strategies to help peers persevere at learning tasks)	<ul style="list-style-type: none">➤ Have students prepare and use acronyms in order to enhance learning. Have them use numbers and letter codes. ➤ Have students consider the management of their physical environment by asking them to consider the role of the following in their learning:<ul style="list-style-type: none">• seating arrangement• classroom décor• classroom setting ➤ Have students work in small groups in order to properly put together the pieces of a puzzle. After the activity, discuss with the class the role and importance of cooperation in order to complete the task.



SUGGESTIONS FOR ASSESSMENT

- Look for evidence that students are able to
 - use strategies such as acronyms in order to enhance understanding
 - use strategies in new, specific situations

- In a reflection journal, have students consider the role of seating arrangement, classroom décor, and classroom setting in their learning.

- Look for evidence that students are able to
 - identify the role of cooperation in order to complete a task
 - select and use appropriate affective strategies

SUGGESTED LEARNING RESOURCES

Global Understandings: A Framework for Teaching and Learning
pp. 98–103



Notes

APPENDICES
YEAR 4

Appendix A

Autoevaluación para la escritura

Nombre _____ Fecha _____

Selección para la escritura _____

Marca la casilla apropiada.

1er borrador

borrador final

Marca una respuesta “sí” o “no” para cada pregunta. La respuesta “no” indica las áreas que necesitan atención. Elige por lo menos dos áreas de CONTENIDO y de GRAMÁTICA Y ORTOGRAFÍA, respectivamente, que necesitan atención. Completa la sección tres, ESTABLECIMIENTO DE OBJETIVOS.

SECTION ONE: CONTENT

1. ¿Mi escritura tiene sentido?
2. ¿Mis ideas son claras?
3. ¿Digo lo que quiero decir?
4. ¿Mi oración introductoria atrae la atención del lector?
5. ¿Mis oraciones de apoyo son detalladas y pertinentes?
6. ¿Me mantengo en el tema?
7. ¿Mis ideas están en orden?
8. ¿Completo cada idea?
9. ¿Uso una variedad de palabras y una variedad de oraciones?
10. ¿Tengo una oración eficaz para concluir?

sí	no

CONTENT:/CONTENIDO:

Áreas en las que hay que trabajar:

Autoevaluación para la escritura (continuación)

Nombre _____ Fecha _____

Selección para la escritura _____

SECCIÓN DOS: GRAMÁTICA Y ORTOGRAFÍA

1. ¿He verificado si hay errores de ortografía?
2. ¿Usé recursos de ortografía /vocabulario (diccionario, tesauro, corrector de ortografía) para ayudarme con la ortografía correcta?
3. ¿He usado correctamente la puntuación final, las comas, las comillas y los dos puntos?
4. ¿Usé las letras mayúsculas dónde era necesario?
5. ¿Verifiqué la concordancia de sujeto /verbo?
6. ¿Usé el formato apropiado para este género de escritura?

sí	no

GRAMÁTICA Y ORTOGRAFÍA

<p>Áreas en las que hay que trabajar:</p>

SECCIÓN TRES: ESTABLECIMIENTO DE OBJETIVOS

1. Objetivos para el Contenido:	Plan de acción:	Indicador de éxito:
2. Objetivos para la Gramática y la Ortografía:	Plan de acción:	Indicador de éxito:

Evaluación de la escritura del compañero/de la compañera

Nombre del estudiante _____

Forma o género del trabajo escrito _____

Compañero(a) editor(a) _____

Fecha _____

A. Después de leer tu trabajo escrito, quisiera felicitarte por lo siguiente:

B. Los siguientes rubros que están “marcados,” son las áreas de tu trabajo escrito que necesitan atención:

- | | |
|------------------------------------|------------------------------------|
| ____ oración introductoria | ____ ortografía |
| ____ oraciones detalladas de apoyo | ____ uso de mayúsculas |
| ____ organización de las ideas | ____ puntuación |
| ____ orden de las ideas | ____ concordancia de sujeto/verbo |
| ____ claridad de las ideas | ____ estructura de la oración |
| ____ oración para concluir | ____ frases/palabras de transición |

C. Comentarios/Recomendaciones:

Primer borrador del diseño para la escritura

Nombre _____ Tema/Tarea _____
Fecha _____ Formato de pre-escritura _____

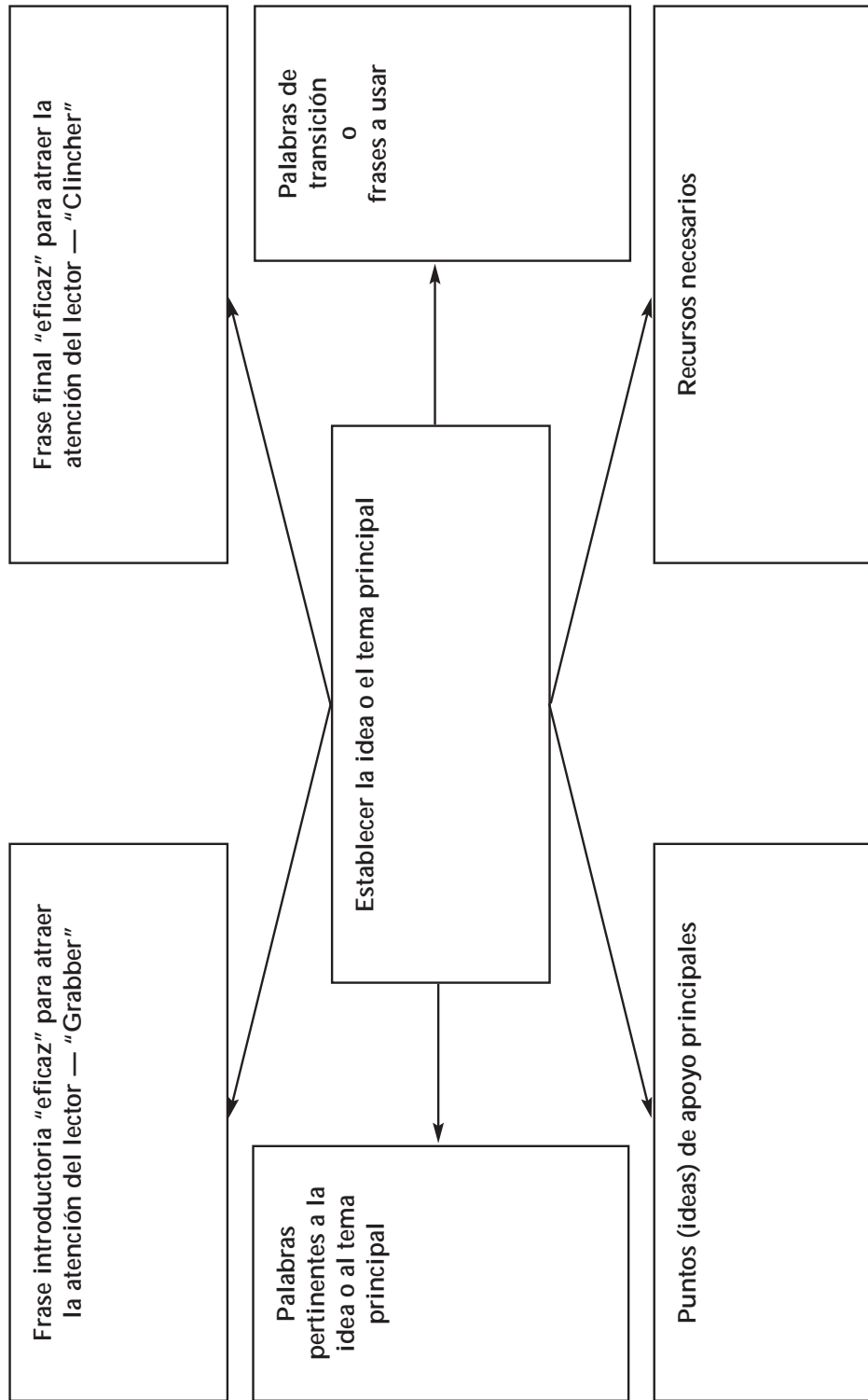

YEAR 5

Applications	3
Language Competence	21
Global Citizenship	53
Strategies	69

APPLICATIONS
YEAR 5



Applications

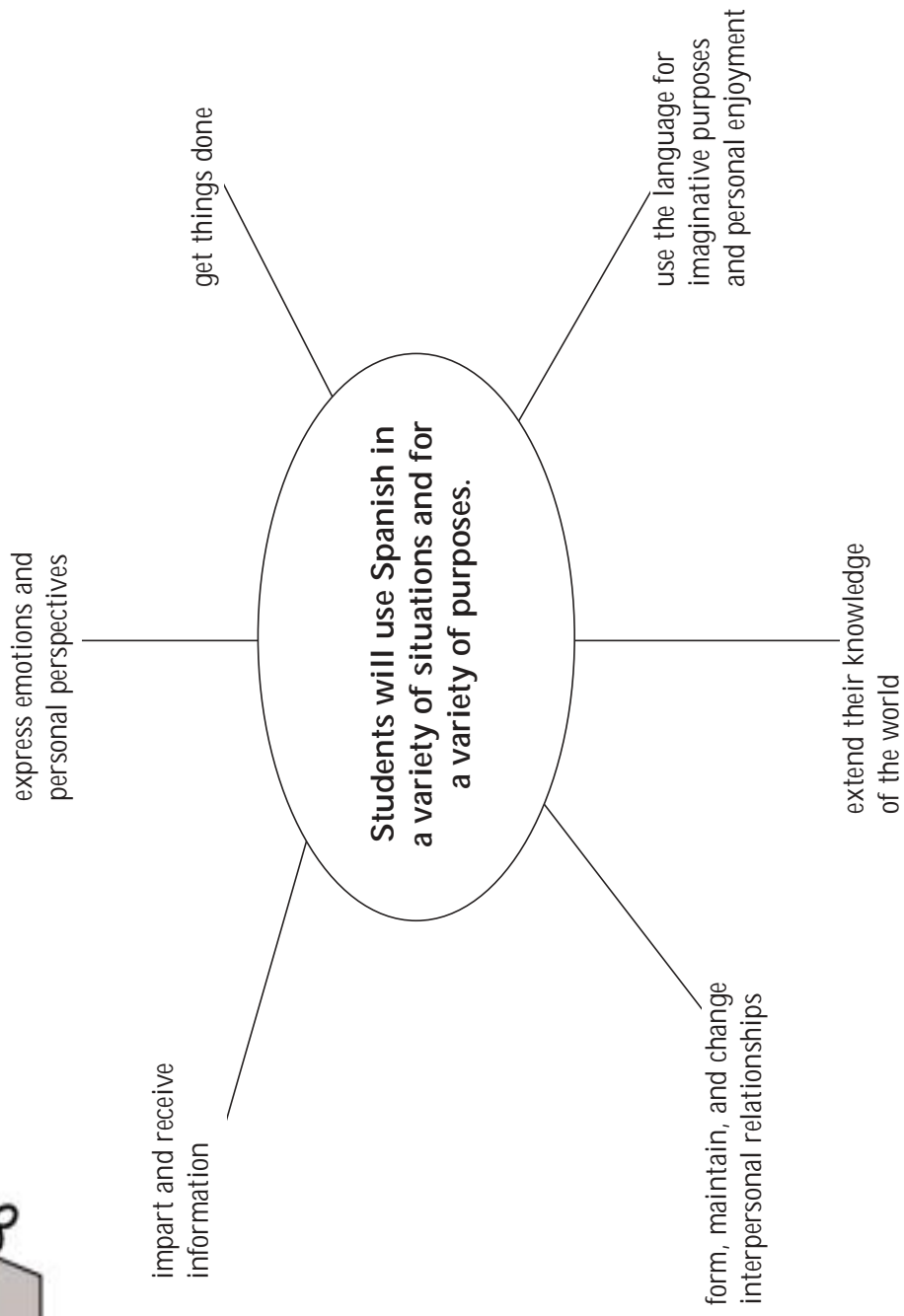
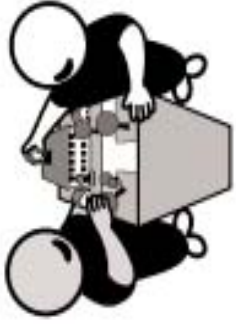



APPLICATIONS

General Outcome 1: Students will use Spanish in a variety of situations and for a variety of purposes.

The specific outcomes under the heading Applications deal with **what** the students will be able to do with the Spanish language, that is, the **functions** they will be able to perform and the **contexts** in which they will be able to operate. This functional competence, also called actional competence, is important for a content-based or task-based approach to language learning where students are constantly engaged in meaningful tasks (Celce-Murcia, Dörnyei, and Thurrell).

The functions are grouped under six cluster headings—see the illustration on the preceding page. Under each of these headings, there are one or more strands. Each strand deals with a specific language function (e.g., share factual information). Students at any grade level will be able to share factual information. Beginning learners will do this in very simple ways (e.g., “This is my dog.”). As students gain more knowledge and experience, they will broaden the range of subjects they can deal with, they will learn to share information in writing as well as orally, and they will be able to handle formal and informal situations.

Different models of communicative competence have organized language functions in a variety of ways. The organizational structure chosen here reflects the needs and interests of students in a classroom where activities are focused on meaning and are interactive. For example, the strand entitled **manage group actions** has been included to ensure that students acquire the language necessary to function independently in small groups, since this is an effective way of organizing second language classrooms. The strands under the cluster heading **to extend their knowledge of the world** will accommodate a content-based approach to language learning where students learn content from another subject area as they learn the Spanish language.

The level of linguistic, sociolinguistic, and discourse competence that students will exhibit when carrying out the functions is defined in the specific outcomes for Language Competence for each course. To know how well students will be able to perform the specific function, the Applications outcomes must be read in conjunction with the Language Competence outcomes.



PRESCRIBED OUTCOMES	SUGGESTIONS FOR INSTRUCTION
<p>General Outcome 1: Applications Students will use Spanish in a variety of situations and for a variety of purposes.</p> <p>1.1 impart and receive information</p> <p>1.1.1 <i>Share Factual Information</i></p> <ul style="list-style-type: none">❖ share facts about events that took place in the past or that may take place in the future <p>1.2 express emotions and perspectives</p> <p>1.2.1 <i>Share Ideas, Thoughts, Opinions, Preferences</i></p> <ul style="list-style-type: none">❖ inquire about and express probability and certainty	<p>➤ Have students work in groups of four. Provide each group with a different article on the same topic written in Spanish from magazines, newspapers, radio or TV programs, or documentaries. Have each group generate four questions based on key information. Then have students regroup so that each member of the group has a different article, with four questions (Jigsaw). Have students then pool their information and ask each other the generated questions in order to get a complete picture of the topic.</p> <p>➤ Construct an anticipation guide that consists of three to eight short statements that reflect major ideas around the themes of the media and its impact or around a current event. Present the statements to the students and ask them to either agree or disagree, justifying their choice based on their current information or knowledge. Have students read, view, or listen to the materials on the topics of the impact of the media or a current event. Then have students return to their anticipation guides to determine whether their thinking has altered by the exposure to the new content, and to identify ideas that have been confirmed (Manitoba Education and Training, <i>Grades 5 to 8 English Language Arts: A Foundation for Implementation</i>, Grade 6 – 11).</p>



SUGGESTIONS FOR ASSESSMENT

SUGGESTED LEARNING RESOURCES

- When students work with magazine or newspaper articles, look for evidence that they are able to ask appropriate questions to find key information.

Language Use Strategies Outcomes:

- predict meaning by interpreting graphics and pictures
- locate familiar words/focus on key words
- use the context to support inferences about the information
- focus on finding the key information they need

¡En español! 2
 Etapa 3
 p. 71A Teacher’s Resource
 p. 71 Student’s Book

¡Buen Viaje! 3
 Sección periodismo

- When students work with anticipation guides, look for evidence that they are able to
 - express an opinion/preference using support data/justification
 - use information found in materials which they have viewed or listened to in order to support/refute opinions
 - speak with comfort and confidence about opinions and preferences (language competence, interactive fluency)

¡Buen Viaje! 3
 Capítulo 2, pp. 80–83
 Capítulo 5
 Sección periodismo
 Capítulo 7
 Sección periodismo



PRESCRIBED OUTCOMES	SUGGESTIONS FOR INSTRUCTION
<p>1.2 express emotions and perspectives (continued)</p> <p>1.2.2 <i>Share Emotions, Feelings</i></p> <ul style="list-style-type: none">❖ express emotions and feelings in formal situations (e.g., make a complaint in a store, restaurant)	<ul style="list-style-type: none">➤ Display several paintings from the Spanish-speaking world. Encourage student to identify feelings the paintings evoke, giving reasons for these responses.
<p>1.3 get things done</p> <p>1.3.1 <i>Guide Actions of Others</i></p> <ul style="list-style-type: none">❖ make and respond to suggestions or requests in formal situations (e.g., in a public library, post office, travel agency)	<ul style="list-style-type: none">➤ Have students role-play several situations related to travel (e.g., booking a trip at the travel agency, ordering in a restaurant, booking a room in a hotel, etc.).



SUGGESTIONS FOR ASSESSMENT

- When students express feelings evoked by paintings, look for evidence that they are able to
 - provide a relevant overall impression or interpretation
 - offer a personal perspective or reaction
 - make connections with other experiences

SUGGESTED LEARNING RESOURCES

¡En español 2
 Etapa 2
 Chicago' pp. 50, 53, 66, 67

¡En español 3
 Unidad 3, Etapa 2
 pp. 212, 213

¡En español! 2
 Video
 En Colores: El arte latino de Chicago

¡Dime! Pasaporte al mundo 21
 Unidad 2, Lección 1
 pp. 90,91
 Unidad 2, Lección 2
 pp. 100–106

¡Dime! Uno
 Unidad 6, Lección 2
 p. 287
 Unidad 6, Lección 3
 pp. 300, 301

¡Buen Viaje! 2
 Capítulo 13, pp. 390, 391



PRESCRIBED OUTCOMES	SUGGESTIONS FOR INSTRUCTION
<p>1.3 get things done (continued)</p> <p>1.3.2 <i>State Personal Actions</i></p> <ul style="list-style-type: none">❖ accept or decline an offer or invitation with explanations	<ul style="list-style-type: none">➤ Provide students with a model dialogue in which someone is inviting someone else to do an activity during a trip to a Spanish-speaking country.
<p>1.3.3 <i>Manage Group Actions</i></p> <ul style="list-style-type: none">❖ paraphrase, elaborate on, and clarify another member's contribution	<ul style="list-style-type: none">➤ Have students prepare questions of classmates about their dream trip destination or itinerary. Students ask these questions and provide responses to elaborate and clarify information provided in the itineraries and visual interpretations of dream trips. Have the class then select one travel destination, based on visual interpretations and possible itineraries of dream trips provided.



SUGGESTIONS FOR ASSESSMENT

**SUGGESTED LEARNING
RESOURCES**

- When students question classmates about visual interpretation and itinerary, look for evidence that they
 - ask pertinent questions to clarify and obtain additional information
 - add relevant comments to enhance information

Planet@ 2
Tema 3



PRESCRIBED OUTCOMES	SUGGESTIONS FOR INSTRUCTION
<p>1.4 extend their knowledge of the world</p> <p>1.4.1 <i>Discover and Explore</i></p> <ul style="list-style-type: none">❖ explore and express the meaning of what they are doing (e.g., what they will learn from a particular activity) <p>1.4.2 <i>Gather and Organize Information</i></p> <ul style="list-style-type: none">❖ gather information, using a prepared format (e.g., interview people, using prepared questions)	<p>➤ Have students read a legend in Spanish (e.g., <i>“La tortuga y la liebre”</i>). Then have students compare this legend to the English version or try to find an equivalent in the Canadian context. Discuss with students the relevance of the legend in the present time, making connections between the legend and present day life.</p> <p>➤ Divide the class into groups and give each group a different section of the same magazine article. Have each group analyze and paraphrase its section. Then ask students to form new groups to share the main ideas of all sections and arrange them in logical sequences. Have these groups represent their collaborative understanding of the article in series of cartoon panels or illustrations (BC <i>Resource Package</i>, 38).</p>



SUGGESTIONS FOR ASSESSMENT

SUGGESTED LEARNING RESOURCES

- When students read and discuss legends, look for evidence that they are able to
 - offer a personal perspective or reaction when making connections with present day life
 - provide the main ideas of both legends
 - provide a relevant interpretation of the common meaning of the legend

- When students work in groups with magazine articles, look for evidence that they
 - ask appropriate questions to find information and details needed
 - focus on key words and phrases
 - make logical inferences based on language/vocabulary used to organize the article into logical sequence

¡En español! 2
 Unidad 2, Etapa 3
 pp. 116, 117
 El monte de nuestro Alimento

¡En español! 2
 Unidad 5, Etapa 3
 pp. 376, 377
 La cascade de la novia

<www.andaluciaglobal.com>

¡Buen Viaje! 1A
 pp. 228, 233

¡Buen Viaje! 1B
 pp. 448–453

¡Buen Viaje! 2
 pp. 440, 441

¡Dime! Dos



PRESCRIBED OUTCOMES	SUGGESTIONS FOR INSTRUCTION
<p>1.4 extend their knowledge of the world (continued)</p> <p>1.4.2 <i>Gather and Organize Information (continued)</i></p> <ul style="list-style-type: none">❖ gather information, using a prepared format (e.g., interview people, using prepared questions) <p>1.4.3 <i>Solve Problems</i></p> <ul style="list-style-type: none">❖ use information collected from various sources to solve problems <p>1.4.4 <i>Explore Opinions and Values</i></p> <ul style="list-style-type: none">❖ distinguish fact from opinion	<p>➤ Invite each student to choose an article from a magazine, newspaper, or the Internet and to note interesting facts. Students prepare a simple summary of the article, using the following basic rules of summarization:</p> <ol style="list-style-type: none">1. Delete trivial and repetitious information.2. Collapse lists—group them into broader categories.3. Use the topic sentence.4. Integrate information—use key ideas and topic sentences to write a summary. <p>Have students present their findings to the class or small groups. As a follow-up, students could write or email letters to the editor (Manitoba Education and Training, <i>Grades 5 to 8 English Language Arts: A Foundation for Implementation</i>, Grade 6 – 80).</p> <p>➤ Present a situation from world/current events (e.g., conflicts between countries, sports matters, etc.). In groups of three, have students elaborate three possible solutions. Discuss solutions with the class and together choose the three best possible solutions.</p> <p>➤ Using the Internet or actual newspapers, have students compare the press in North America and Spanish-speaking countries (e.g., differences in characteristics, content, coverage of world events).</p>



SUGGESTIONS FOR ASSESSMENT

SUGGESTED LEARNING RESOURCES

- When students prepare summaries of articles, provide students with a checklist based on the rules of summarization provided. Look for evidence that, in the summary, students are able to
 - identify the topic sentence
 - focus on key words and phrases
 - include only relevant information, without trivial and repetitious information
 - present summaries clearly, with generally accurate pronunciation and intonation (language competence, attend to form)

- When students work in groups to find solutions to situations in world/current events, look for evidence that students
 - suggest solutions that are logical and relate to the problem
 - allow each student to provide possible solutions

- When students compare the press in North America and in Spanish-speaking countries, look for evidence that they
 - give specific examples of differences in characteristics, content, and coverage of world events
 - suggest possible reasons for differences

¡Buen Viaje! 3
Sección periodismo

Planet@ 4
Tema 2, p. 46



PRESCRIBED OUTCOMES	SUGGESTIONS FOR INSTRUCTION
<p>1.5 imaginative purposes and personal enjoyment</p> <p>1.5.1 <i>Humour/Fun</i></p> <ul style="list-style-type: none">❖ use the language for fun and to interpret and express humour (e.g., learn and perform songs, dances, short plays) <p>1.5.2 <i>Creative/Aesthetic Purposes</i></p> <ul style="list-style-type: none">❖ use the language creatively and for aesthetic purposes (e.g., create a multimedia presentation on a familiar topic)	<p>➤ Present students with several editorial cartoons. In groups or in pairs, have students interpret the cartoons. Discuss the interpretations with the class and establish some of the main characteristics of editorial cartoons. Have students then draw an editorial cartoon related to a current event and present their cartoon to the class.</p> <p>➤ Have students read simple myths or legends from the Spanish-speaking world and present them through media of their choice (e.g., skits, puppet shows) (<i>BC Resource Package</i>, 48).</p> <p>(See Ideas for Exhibitions and Projects in Classroom Assessment, pp. 24–25.)</p>



SUGGESTIONS FOR ASSESSMENT

- When students interpret and the create their own editorial cartoons, look for evidence that students are able to
 - identify the current event to which the cartoon refers
 - identify the main characteristics as well as the element of humour in editorial cartoons
 - explain any cultural references in the cartoon
 - use knowledge of characteristics of an editorial cartoon to create their own humorous cartoon (language competence, discourse)

- Work with students to develop criteria for their dramatic presentations of myths or legends from Spanish-speaking regions. Criteria might include the following:
 - develops a clear feeling, theme, or message that is consistent with the original
 - sequences events to create a coherent story
 - reflect key qualities of the characters
 - incorporates conventions and traditions
 - uses interesting and unusual detail to create a unique perspective or interpretation that engages the audience

SUGGESTED LEARNING RESOURCES

- ¡En español! 3*
Unidad 1, Etapa 3
pp. 76,77
- ¡Dime! Pasaporte al mundo 21*
pp. 392, 393
-
- ¡Dime! Dos*
Sección: Cultura
All units
- ¡Dime! Pasaporte al mundo 21*
Unidad 5, Lección 1
pp. 221-227
Unidad 7, Lección 1
pp. 329–335
- ¡Buen Viaje! 1A*
pp. 228–233
- ¡Buen Viaje! 1B*
pp. 448–453
- ¡Buen Viaje! 2*
pp. 440, 441
- Planet@ 3*
Tema 5
pp. 136–137



PRESCRIBED OUTCOMES	SUGGESTIONS FOR INSTRUCTION
<p>1.5 imaginative purposes and personal enjoyment (continued)</p> <p>1.5.3 <i>Personal Enjoyment</i></p> <ul style="list-style-type: none">❖ use the language for personal enjoyment (e.g., use the Internet to explore the culture being studied)	<p>➤ Have students watch a movie or cartoon of their choice in Spanish and encourage them to express their impressions of it.</p>
<p>1.6 form, maintain, and change interpersonal relationships</p> <p>1.6.1 <i>Manage Personal Relationships</i></p> <ul style="list-style-type: none">❖ give and respond to compliments, and explain actions	<p>➤ Have students work in pairs in order to read a news article. Have students then determine how they could best communicate the information found in the article to another pair. Students then move into groups of four, with each pair presenting the information found in their news article in a unique way. Have students then discuss the strengths of another pair's presentation, using appropriate compliments.</p>



SUGGESTIONS FOR ASSESSMENT

SUGGESTED LEARNING RESOURCES

- When students watch a Spanish movie or cartoon, look for evidence that they show interest and listen actively.

¡En español! 3
 Unidad 5, Etapa 3
 pp. 380, 381
 En colores
 Tres directores

¡Dime! Pasaporte al mundo 21
 Unidad 8, Lección 1
 pp. 392–393

- When students work in pairs and then in groups of four to interpret information about a news article, look for evidence that they are able to
 - interpret information in article accurately
 - present information to another pair effectively: gestures used, expression used, message clear
 - use appropriate vocabulary to express compliments and strengths of presentations

¡En español! 2
 p. 71

¡Buen Viaje! 3
 Sección periodismo

Planet@ 4
 Tema 2
 p. 46



Notes

*LANGUAGE
COMPETENCE
YEAR 5*



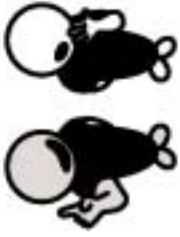

Language Competence

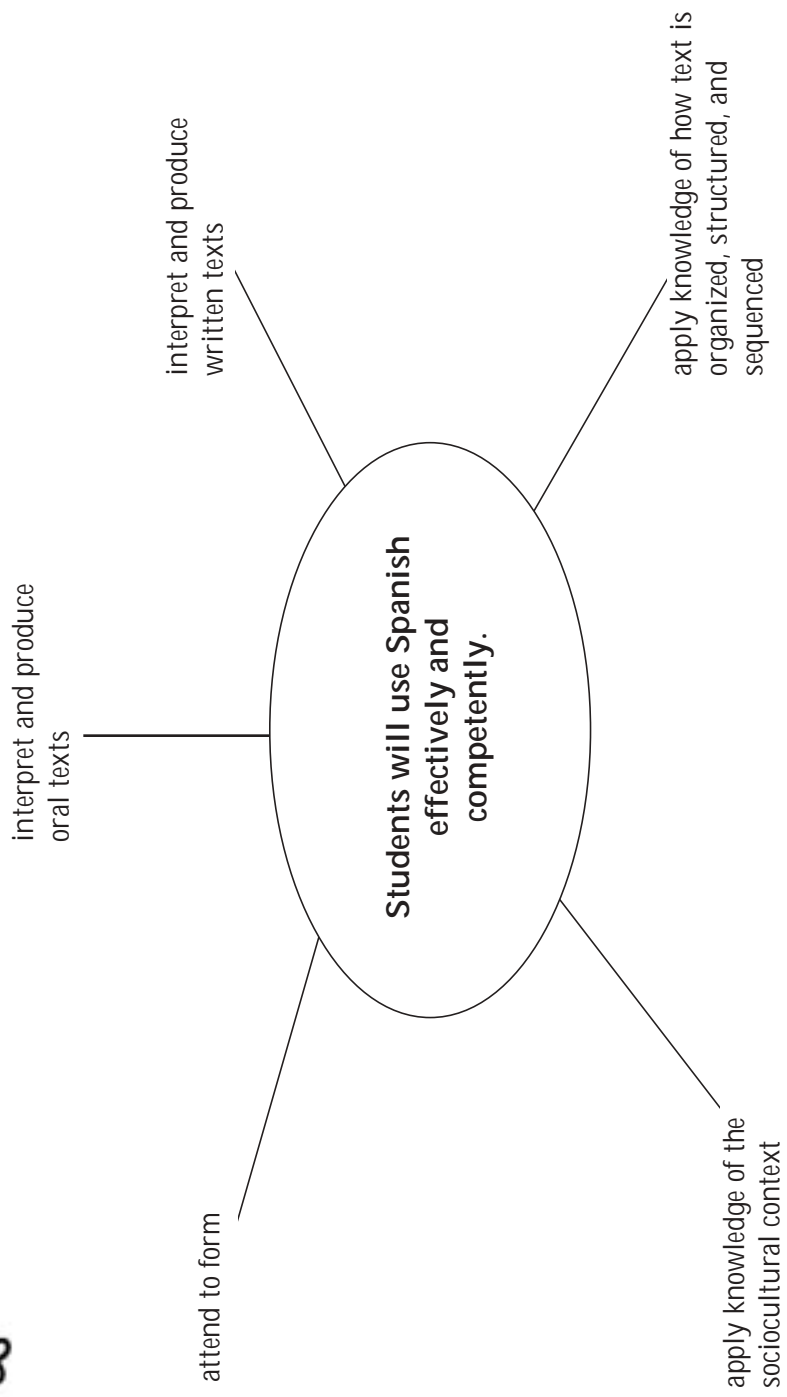



LANGUAGE COMPETENCE

General Outcome 2: Students will use Spanish effectively and competently.

Language competence is a broad term that includes linguistic or grammatical competence, discourse competence, sociolinguistic or sociocultural competence, and what might be called textual competence. The specific outcomes under Language Competence deal with knowledge of the Spanish language and the ability to use that knowledge to interpret and produce meaningful texts appropriate to the situation in which they are used. Language competence is best developed in the context of activities or tasks where the language is used for real purposes, in other words, in practical **applications**.

The various components of language competence are grouped under four cluster headings—see the illustration on the preceding page. Under each of these headings there are several strands. Each strand deals with a single aspect of language competence. For example, under the cluster heading **attend to form**, there is a strand for phonology (pronunciation, stress, intonation), orthography (spelling, mechanical features), lexicon (vocabulary words and phrases), and grammatical elements (syntax and morphology).

Although the outcomes isolate these individual aspects, language competence should be developed through learning activities that focus on meaningful uses of the Spanish language and on **language in context**. Tasks will be chosen based on the needs, interests, and experiences of students. The vocabulary, grammar structures, text forms, and social conventions necessary to carry out a task will be taught, practised, and assessed as students are involved in various aspects of the task itself, **not in isolation**.

Strategic competence is often closely associated with language competence, since students need to learn ways to compensate for low proficiency in the early stages of learning if they are to engage in authentic language use from the beginning. This component is included in the language use strategies in the Strategies section.



PRESCRIBED OUTCOMES	SUGGESTIONS FOR INSTRUCTION
<p>General Outcome 2: Language Competence Students will use Spanish effectively and competently.</p> <p>2.1 attend to form</p> <p>2.1.1 <i>Phonology</i></p> <ul style="list-style-type: none">❖ use intonation, stress, and rhythm appropriately in familiar situations <p>2.1.2 <i>Orthography</i></p> <ul style="list-style-type: none">❖ use basic mechanical conventions (e.g., capitalization, punctuation)❖ use basic spelling patterns in writing unfamiliar words and phrases	<p>➤ Have students recite poems or tongue twisters in order to practice the production of essential sounds, stress, rhythm, and intonation patterns of Spanish.</p> <p>➤ Have students independently edit and peer edit their work.</p>



SUGGESTIONS FOR ASSESSMENT

**SUGGESTED LEARNING
RESOURCES**

- Look for evidence that students spell target vocabulary accurately in a variety of situations.

Colección tiempo: Para pronunciar

Rosetta Stone II and III

Planet@ 3 and 4

Sección: Ruta literaria



PRESCRIBED OUTCOMES
<p>2.1 attend to form (continued)</p> <p>2.1.3 <i>Lexicon</i></p> <ul style="list-style-type: none">❖ use a repertoire of words and phrases in familiar contexts that meet the needs and interests of students, particularly within the following areas of experience:<ul style="list-style-type: none">— fine arts— legends and myths— communications technology and media<ul style="list-style-type: none">✓ power and impact of media and advertising— travel— world/current events<ul style="list-style-type: none">✓ differences in media coverage of events in different nations❖ use a small range of vocabulary to convey shades of meaning

SUGGESTIONS FOR INSTRUCTION



SUGGESTIONS FOR ASSESSMENT

**SUGGESTED LEARNING
RESOURCES**

USO interactivo del vocabulario

Imágenes de España

Material de prácticas

Imágenes de América Latina

Material de prácticas

Rosetta Stone II and III



PRESCRIBED OUTCOMES	SUGGESTIONS FOR INSTRUCTION
<p>2.1 attend to form (continued)</p> <p>2.1.4 <i>Grammatical Elements</i></p> <ul style="list-style-type: none">❖ use, in modelled situations, the following grammatical elements:<ul style="list-style-type: none">— future tense— conditional mood— subjunctive mood— present subjunctive:<ul style="list-style-type: none">✓ to express wishes and hope: <i>Ojalá que ..., quiero que</i>✓ to express emotion: <i>alegrarse, sentir ...</i>✓ to express persuasion: <i>aconsejar, decir, desear, pedir</i>✓ after impersonal expressions: <i>es una lástima que ..., es necesario que ...</i>✓ after <i>cuando</i> and <i>aunque</i>✓ to express doubt— gerund with imperfect of <i>estar</i>— impersonal verb form with <i>se</i>	<p>Modelled Situations: This term is used to describe learning situations where a model of specific grammatical elements is consistently provided and immediately available. Students in such situations will have an emerging awareness of the grammatical elements and be able to apply them in very limited situations. Limited fluency and confidence characterize student language.</p> <p>Example of a modelled situation:</p> <p>In preparation for a group project, students will keep a journal of their daily activities for a week. Students practise the structure “<i>tener que + infinitive</i>” using the sentence patterns provided. Each student asks five classmates, <i>¿Qué tienes que hacer después de clases hoy?</i> Students answer saying, <i>Tengo que . . .</i>, with an infinitive of their choice. Each person then summarizes the results of their mini survey, <i>Tres estudiantes tienen que estudiar</i>, and so on.</p>



SUGGESTIONS FOR ASSESSMENT

**SUGGESTED LEARNING
RESOURCES**

Colección tiempo: Para conjugar
Rosetta Stone II and III



PRESCRIBED OUTCOMES	SUGGESTIONS FOR INSTRUCTION
<p>2.1 attend to form (continued)</p> <p>2.1.4 <i>Grammatical Elements (continued)</i></p> <ul style="list-style-type: none">❖ use, in structured situations, the following grammatical elements:<ul style="list-style-type: none">— possessive pronouns: <i>mío, tuyo, suyo, míos, tuyos, suyos</i>— indirect object pronouns— double object pronouns— preterite tense (irregular verbs)— imperfect tense— preterite tense vs. imperfect tense— comparative, superlative, and diminutive	<p>Structured Situations: This term is used to describe learning situations where a familiar context for the use of specific grammatical elements is provided and students are guided in their use. Students in such situations will have increased awareness and emerging control of the grammatical elements and be able to apply them in familiar contexts with teacher guidance. Student language is characterized by increasing fluency and confidence.</p> <p>Example of a structured situation:</p> <p>In preparation for a research project on typical activities of young people in selected Spanish-speaking countries, students listen to a rapid conversation where a Canadian student is talking to an exchange student from Mexico. The students check off, on a prepared answer sheet, what the exchange student does and does not do.</p>



SUGGESTIONS FOR ASSESSMENT

**SUGGESTED LEARNING
RESOURCES**

Colección tiempo: Para conjugar
Rosetta Stone II and III



PRESCRIBED OUTCOMES	SUGGESTIONS FOR INSTRUCTION
<p>2.1 attend to form (continued)</p> <p>2.1.4 <i>Grammatical Elements (continued)</i></p> <ul style="list-style-type: none">❖ use, in independent situations, the following grammatical elements:<ul style="list-style-type: none">— commands—negative forms— commands—irregular verbs (<i>tú</i> form)— stem-changing verbs in the present tense— irregular verbs: <i>dar, poner, traer</i>— preterite tense (regular verbs)— perfect tense— direct object pronouns— reflexive verbs	<p>Independent Situations: This term is used to describe learning situations where students use specific grammatical elements in a variety of contexts with limited teacher guidance. Students in such situations will have consistent control of the grammatical elements and be able to apply them in a variety of contexts with limited teacher guidance. Fluency and confidence characterize student language.</p> <p>Example of an independent situation: Students send a letter, an email message, or a recorded message to a Spanish-speaking pen pal explaining what they do regularly.</p>



SUGGESTIONS FOR ASSESSMENT

**SUGGESTED LEARNING
RESOURCES**

SUGGESTIONS FOR ASSESSMENT	SUGGESTED LEARNING RESOURCES



PRESCRIBED OUTCOMES	SUGGESTIONS FOR INSTRUCTION
<p>2.2 interpret and produce oral texts</p> <p><i>2.2.1 Aural Interpretation</i></p> <ul style="list-style-type: none">❖ understand a variety of short texts on unfamiliar topics in guided situations <p><i>2.2.2 Oral Production</i></p> <ul style="list-style-type: none">❖ produce a variety of short, simple texts in guided and unguided situations	<ul style="list-style-type: none">➤ Have students listen to a radio ad or view a TV ad. In pairs or in small groups, have students identify the product, some details about the product, the slogan, and the target audience.➤ Show students a Spanish commercial, cutting off the message at the end of the commercial. Students must then guess what the message is, based on what they saw and heard in the first part of the message. Discuss students' ideas for the message and then play the whole commercial.➤ On a monthly basis, assign students in groups to take turns presenting a classroom bulletin board that focuses on the Spanish-speaking world. Suggest that groups display short newspaper and magazine articles that they collect. At the end of each month, have the assigned group present an oral synopsis of the posted items (<i>BC Resource Package</i>, 340).➤ On a monthly or weekly basis, assign students in groups one section of the newspaper (e.g., front page, arts and entertainment, etc.). Suggest that students collect samples from Spanish newspapers that represent the section that they have been assigned and then have them give an oral summary of the characteristics of that section and the information found.



SUGGESTIONS FOR ASSESSMENT

- When students view Spanish commercials, look for evidence that they
 - identify the message
 - have used specific details in their interpretation
 - are open to considering a variety of views and interpretations

- Establish expectations and criteria for bulletin-board displays and synopses through discussion with students. Criteria might include the following:
 - synopses are accurate, focus on key events or stories, and include interesting details to support the main point
 - information comes from a variety of sources
 - display is organized around a common theme (main point)
 - a variety of topics and Spanish-speaking cultures are included

SUGGESTED LEARNING RESOURCES

Colección tiempo: Para comprender

¡En español! 2
Unidad 1, Etapa 3

¡Buen Viaje! 3
Capítulo 5
p. 223



PRESCRIBED OUTCOMES	SUGGESTIONS FOR INSTRUCTION
<p>2.2 interpret and produce oral texts (continued)</p> <p>2.2.3 <i>Interactive Fluency</i></p> <ul style="list-style-type: none">❖ manage simple, routine interactions without undue difficulty, asking for repetition or clarification when necessary	<ul style="list-style-type: none">➤ Have students role-play a situation that involves preparation for a travel destination (e.g., call a travel agent for travel arrangements, arrival at the airport and interaction with the ticket agent and/or customs official, on the plane, arrival at the hotel).
<p>2.3 interpret and produce written texts</p> <p>2.3.1 <i>Written Interpretation</i></p> <ul style="list-style-type: none">❖ understand a variety of short texts on unfamiliar topics in guided situations	<ul style="list-style-type: none">➤ Select a legend or myth that has three or four logical stopping points in the story. Have students examine the title, author, and illustrations. Ask students questions to develop predictions about the characters, setting, and plot. Using a Before-During-After Reading Map, record, students' predictions beside B under each of the story elements. Have students read the first segment of the story silently to check predictions. Discuss with students whether or not their predictions were correct and ask them to make predictions about the next segment of reading. Record these predictions in the D (during) section of the map. Continue the predicting-reading-proving cycle until the selection is completed. Record any new information in the A section of the map (Manitoba Education and Training, <i>Grades 5 to 8 English Language Arts: A Foundation for Implementation</i>, Strategies – 146–147).



SUGGESTIONS FOR ASSESSMENT

- As students prepare role plays, discuss assessment criteria with students before they begin. Criteria might include the following:
 - students keep interaction going
 - students are able to handle unexpected events by using short pauses to plan what to say
 - students are able to identify breakdowns in communication and find ways to get meaning across
 - meaning is clear
 - appropriate details are included in questions and answers
 - gestures and body language support communication (strategies)
 - pronunciation and intonation are generally accurate (language competence, attend to form)

(See role-play assessment criteria in Classroom Assessment, p. 11.)

- As students use the Before-During-After Reading Map for the reading of legends or myths, look for evidence that students are able to
 - identify the key elements of the story
 - focus on key words, phrases, and ideas
 - make logical inferences based on the title, author, and illustrations (strategies)

Have students retell the story in written or oral form.

SUGGESTED LEARNING RESOURCES

- ¡Buen Viaje! 2*
Capítulo 1, 6, 7
- ¡Buen Viaje! 3*
Capítulo 1
- Primer plano 2*
Episodios 1 y 2
- Planet@ 2*
Tema 3

- ¡En español! 3*
Unidad 6, Etapa 1
pp. 390–411
- ¡En español! 2*
Unidad 2, Etapa 2
pp. 116, 117
Unidad 5, Etapa 3
pp. 376, 377
- Hadaluna Lee
<www.andaluciagobal.com>
- Planet@ 3 and 4*
Sección: Ruta literaria



PRESCRIBED OUTCOMES	SUGGESTIONS FOR INSTRUCTION
<p>2.3 interpret and produce written texts (continued)</p> <p>2.3.1 <i>Written Interpretation (continued)</i></p> <ul style="list-style-type: none">❖ understand a variety of short texts on unfamiliar topics in guided situations <p>2.3.2 <i>Written Production</i></p> <ul style="list-style-type: none">❖ produce a variety of short, simple texts in guided and unguided situations	<ul style="list-style-type: none">➤ Have students read a review of a movie, TV show, performance, or music CD. Students must identify the main points of the review, as well as some supporting details. ➤ Provide students with examples of Spanish legends and myths. Read these together or in groups, with students taking turns to read out loud. Discuss and reflect on the story, characters, and author’s intent or theme. Have groups choose a legend/myth and rewrite it into a script. Students then present the script in Reader’s Theatre style, using voice projection, intonation, vocal and facial expression, and gestures. Note that in Reader’s Theatre narrators often stand and characters sit.



SUGGESTIONS FOR ASSESSMENT

SUGGESTED LEARNING RESOURCES

- As students work with reviews, look for evidence that they are able to
 - identify the main points
 - provide details
 - use cognates and contextual clues to derive meaning

- When students prepare and present a script of a Spanish legend or myth in Reader’s Theatre style, discuss assessment criteria with students before they begin. Criteria might include the following:
 - main ideas and supporting details are evident in storyline
 - appropriate vocal and facial expressions as well as gestures are used (strategies)

Language Competence Outcomes:

 - appropriate language structures and verb tenses are used
 - voice is projected with appropriate intonation
 - pronunciation is generally accurate

¡En español! 3
 Unidad 5
 pp. 386, 387

¡Buen Viaje! 1A
 pp. 228–233

¡Buen Viaje! 1B
 pp. 448–453

¡Buen Viaje! 2
 pp. 440, 441

Planet@ 2 and 3
 Sección: Ruta literaria



PRESCRIBED OUTCOMES
<p>2.3 interpret and produce written texts (continued)</p> <p>2.3.2 <i>Written Production (continued)</i></p> <ul style="list-style-type: none">❖ produce a variety of short, simple texts in guided and unguided situations
<p>2.3.3 <i>Visual Interpretation</i></p> <ul style="list-style-type: none">❖ derive meaning from multiple visual elements in a variety of media in guided and unguided situations

SUGGESTIONS FOR INSTRUCTION

➤ Have students prepare a magazine, newsletter, or newspaper on either a variety of topics or one specific topic (e.g., sports, current events/issues, famous people etc.).

- Invite students to examine cartoons or comic strips written in Spanish and to note common expressions. Have students pay particular attention to the visual. Have students think about what meaning is communicated visually and how it is done.
- Have students view a variety of Spanish commercials and have them identify the specific purpose, intended audience, and message of each. Have students consider how the visual component of the commercial contributes to the interpretation.



SUGGESTIONS FOR ASSESSMENT

SUGGESTED LEARNING RESOURCES

- When students prepare a magazine, newsletter, or newspaper, discuss assessment criteria with students before they begin. Criteria might include the following:
 - thoughts, ideas, and feelings are clearly communicated
 - a front page or cover page tells what the document is about
 - visuals support the ideas in the articles
 - accurate and detailed information supports the main point

Language Competence, Attend to Form Outcomes:

- language structures and verb tenses are used appropriately
- spelling is correct
- punctuation is correct

- When students analyze Spanish-language cartoons or comic strips, look for evidence that they are able to interpret the visual to derive additional meaning.
- When students view Spanish commercials, look for evidence that they
 - use visual clues to help identify purpose, intended audience, and message
 - focus on key vocabulary and expressions to help identify purpose, intended audience, and message

¡Buen Viaje! 3
 Capítulo 5
 p. 223

¡Buen Viaje! 3
 Sección periodismo
 Todos los capítulos

¡En español! 2
 Unidad 1



PRESCRIBED OUTCOMES	SUGGESTIONS FOR INSTRUCTION
<p>2.3 interpret and produce written texts (continued)</p> <p>2.3.4 <i>Representation</i></p> <ul style="list-style-type: none">❖ express meaning through the use of multiple visual elements in a variety of media in guided and unguided situations	<ul style="list-style-type: none">➤ Have students use a selection of age-appropriate Spanish-language resources (e.g., magazine articles, videos, Internet) to research a topic (e.g., fashion, sport, music). Form groups and ask each group to create and present a visual display (e.g., collage, chart, poster, brochure, mobile) based on the research (BC <i>Resource Package</i>, 22). ➤ Ask each student to choose and practise a simple Spanish poem and to create a visual that represents the work's main ideas. Students can then read their poems and present their creative works to the class (BC <i>Resource Package</i>, 48). ➤ Have each student select a short article from a newspaper in Spanish, identify three interesting facts in it, and report them to the class. Ask students to present their information in visual formats, with some key words in Spanish added, or exchange visual displays and articles with classmates (BC <i>Resource Package</i>, 30).



SUGGESTIONS FOR ASSESSMENT

- When students create visual displays after exploring articles and reference materials, look for evidence that they are able to
 - communicate thoughts, ideas, and feelings clearly
 - represent the main topics and information accurately
 - include key words or phrases as labels
 - identify their intended audience
 - identify their purpose (what they are trying to communicate)
 - use a variety of visual media
 - work in unguided situations

- When students work with newspaper articles and convey interesting facts to the class, look for evidence that they are able to
 - communicate thoughts, ideas, and feelings clearly
 - use key words and phrases

SUGGESTED LEARNING RESOURCES

- ¡En español! 2*
pp. 448, 449
- ¡En español! 2*
Unidad 1, Etapa 3
- ¡En español! 3*
Unidad 3, Etapa 1
pp. 190, 191
Unidad 3, Etapa 3
pp. 234, 235
- ¡Dime! Dos*
Unidad 1, Lección 2
p. 35
Unidad 3, Lección 2
p. 147
Unidad 8, Lección 3
pp. 437–441
- ¡Buen Viaje! 3*
Capítulo 1, pp. 44–51
Capítulo 2, pp. 92–95
Capítulo 3, pp. 140–144
Capítulo 4, pp. 194–199
Capítulo 5, pp. 236–243
Capítulo 8, pp. 395–407
- Planet@ 2 and 3*
Sección: Ruta literaria



PRESCRIBED OUTCOMES	SUGGESTIONS FOR INSTRUCTION
<p>2.4 apply knowledge of the sociocultural context</p> <p>2.4.1 <i>Register</i></p> <ul style="list-style-type: none">❖ use suitable, simple formal language in a variety of contexts	<ul style="list-style-type: none">➤ Provide students with examples of letters or postcards that were written to describe experiences during travel to various destinations. Discuss with students the type of language used in a familiar writing context such as a postcard. Identify specific vocabulary, language structures, etc. that correspond to a formal or informal register. Have students write a letter or a postcard to a friend, teacher, or family member. The letter or postcard would describe the student’s experiences during a trip to a Spanish-speaking country.➤ Form groups and provide each group with a different Letter to the Editor. Have students read the letter together, examining the organization, sentence structure, and vocabulary used in such a letter. Discuss the audience and purpose of a Letter to the Editor and establish the relationship between the audience, purpose, and language. Have students then write a Letter to the Editor on a current issue that interests them.
<p>2.4.2 <i>Idiomatic Expressions</i></p> <ul style="list-style-type: none">❖ examine the role of idiomatic expressions in culture	<ul style="list-style-type: none">➤ Have students view Spanish commercials and have students work in small groups to identify popular, contemporary expressions (e.g., “Got Milk?”—English).



SUGGESTIONS FOR ASSESSMENT

- Work with students to develop a checklist they can use for self and peer assessment of their letters or postcards. The checklist might include items such as the following:
 - vocabulary and sentence structure suit audience and purpose
 - greeting and closing suit audience and purpose
 - meaning is clear
 - punctuation is correct (language competence, attend to form)
 - spelling is correct (language competence, attend to form)

(See criteria for written material assessment in Classroom Assessment, p. 12.)

- Work with students to develop a checklist they can use for self and peer assessment of their Letter to the Editor. The checklist might include items such as the following:
 - audience and purpose are clear
 - sentence structure and vocabulary are appropriate to audience and purpose
 - organization and form is appropriate to a Letter to the Editor
 - formal register is used
 - punctuation is correct (language competence, attend to form)
 - spelling is correct (language competence, attend to form)

- When students watch Spanish commercials, look for evidence that they are able to
 - identify key vocabulary in order to decipher/ understand idiomatic expressions
 - use visual clues to help provide context

SUGGESTED LEARNING RESOURCES

¡En español! 2
 Unidad 3, Etapa 2
 pp. 213, 214

¡Dime! Dos
 Unidad 8, Lección 3
 pp. 428–430

Internet

Teacher’s Discovery
 <www.teachersdiscovery.com>
 A number of resources are available on this website that may be useful.



PRESCRIBED OUTCOMES	SUGGESTIONS FOR INSTRUCTION
<p data-bbox="103 281 500 386">2.4 apply knowledge of the sociocultural context (continued)</p> <p data-bbox="103 407 461 441">2.4.3 <i>Variations in Language</i></p> <ul data-bbox="175 462 516 533" style="list-style-type: none">❖ experiment with some variations in language <p data-bbox="103 785 409 819">2.4.4 <i>Social Conventions</i></p> <ul data-bbox="175 840 503 1016" style="list-style-type: none">❖ interpret and use a variety of formal and informal social conventions, with guidance <p data-bbox="103 1197 513 1230">2.4.5 <i>Non-verbal Communication</i></p> <ul data-bbox="175 1251 500 1394" style="list-style-type: none">❖ interpret and use a variety of non-verbal behaviours with guidance	<ul data-bbox="607 462 1422 1394" style="list-style-type: none">➤ Have students view a portion of a taped news broadcast (e.g., CNN <i>en español</i>) featuring interviews with ordinary people. Have students identify variations in language (e.g., differences in vocabulary and pronunciation used by the newscaster and by people interviewed). Have students prepare an interview in which they incorporate some identified differences in language. ➤ Have students work in small groups and create skits in which they have to use varying social conventions (e.g., addressing customs officer or a friend during a trip). ➤ Show students clip of a video/film. Ask students to note gestures that are similar and different from gestures of North American culture. Suggest that students try to incorporate gestures into their skits.



SUGGESTIONS FOR ASSESSMENT	SUGGESTED LEARNING RESOURCES
<p>➤ When students view a newscast, look for evidence that they are able to</p> <ul style="list-style-type: none"> • identify expressions/vocabulary that vary from one speaker to another • suggest reasons for differences • identify differences in pronunciation or intonation 	<p><i>¡En español! 2</i> Unidad 1 Local TV Channels</p>
<p>➤ When students prepare a skit using varying social conventions, look for evidence that they are able to</p> <ul style="list-style-type: none"> • apply social conventions • use <i>usted</i> or <i>tú</i> appropriately • speak clearly, with appropriate pronunciation and intonation (language competence, attend to form) • use gestures to help support communication (strategies) 	<p><i>¡Dime! Dos</i> Unidad 2, Lección 2 p. 89 Unidad 6, Lección 2 pp. 310, 311 Unidad 8, Lección 2 p. 423 <i>¡Buen Viaje! 2</i> Capítulo 6,7</p>
<p>➤ When students view films, look for evidence that they are able to</p> <ul style="list-style-type: none"> • identify forms of non-verbal communication such as shaking hands, kissing, hugging, gestures • compare findings with their own culture 	<p><i>Senior 1 Spanish: A Course for Distance Learning</i> Diccionario de gestos</p>



PRESCRIBED OUTCOMES	SUGGESTIONS FOR INSTRUCTION
<p>2.5 apply knowledge of how text is organized, structured, and sequenced</p> <p>2.5.1 <i>Cohesion/Coherence</i></p> <ul style="list-style-type: none">❖ use a variety of conventions to structure texts (e.g., titles, paragraphs, letter forms)❖ interpret and use references within texts (e.g., pronouns, demonstratives) <p>2.5.2 <i>Text Forms</i></p> <ul style="list-style-type: none">❖ use a variety of familiar text forms and media in their own productions (e.g., recipes, comic strips, letters, radio or television reports, articles, tickets, time tables, itinerary)	<ul style="list-style-type: none">➤ Provide students with segments of a cartoon or legend/myth. Either in pairs or small groups, have students place the text in sequential order. Have students identify the words or expressions that helped them recreate the text in the correct order. As an extension, have students retell the story. ➤ Provide students with a variety of texts on the same topic (e.g., TV, radio, and magazine advertisements, letters to the editor, news articles, political propaganda, etc.). Each group may receive a different type of text. Have each group analyze verb tenses used, connecting words, points of view, target audience, and text organization. Each group presents its findings to the class. Have students then choose one type and produce their own text, using the information presented in class as a guideline. ➤ Have students survey informational text to determine how authors present and organize information. Discuss how authors highlight significant information through the use of typographical features such as bold print, italics, shading, icons, and fonts. Students work in pairs or small groups to create questions using key words which are found in headings, sub-headings, bold print, or italics. Students then read the text in order to answer their questions or the questions of another pair/group (Manitoba Education and Training, <i>Grades 5 to 8 English Language Arts: A Foundation for Implementation, Grade 5 – 234</i>).



SUGGESTIONS FOR ASSESSMENT

SUGGESTED LEARNING RESOURCES

- As students reorganize a cartoon/legend/myth into sequential order, look for evidence that they are able to
 - use visual clues to help create context
 - identify words/expressions that help create sequence
 - retell story, reflecting the main ideas
 - retell the story, using words/expressions that help create sequence (sequential markers)

- As students analyze different types of text, look for evidence that they are able to
 - ask appropriate questions to find the necessary information
 - identify the target audience and purpose of text
 - explain how text is organized and give possible reasons for organization
 - identify verb tenses and connecting words that are common in text

- When students analyze informational texts and prepare questions based on headings, sub-headings, bold print, or italics, look for evidence that students are able to
 - identify typographical features of the text and give possible reasons for their use
 - use key words in headings, etc. in order to create questions
 - find answers to questions with the help of headings, key words, and phrases

¡En español! 2
 Unidad 2
 pp. 168, 169
 <www.turning-pages.com/mafalda/>
 <www.quino.com.ar>
¿Qué tal? (Revista)
Planet@ 4
 p. 60
Planet@ 3 and 4
 Sección: Ruta literaria

¡Buen Viaje! 2
 Sección Lecturas Culturales

¡Buen Viaje! 3
 Sección periodismo

¡Dime! Pasaporte al mundo 21
 Section: Ventana al mundo 21

¡Dime! Dos
 Sección: Impacto cultural
 Leamos ahora

¡Dime! Dos
 Unidad 3, Lección 3
 pp. 164, 165

Planet@ 3 and 4
 Sección: Ruta literaria



PRESCRIBED OUTCOMES	SUGGESTIONS FOR INSTRUCTION
<p data-bbox="103 281 558 386">2.5 apply knowledge of how text is organized, structured, and sequenced (continued)</p> <p data-bbox="103 407 318 438">2.5.2 <i>Text Forms</i></p> <ul data-bbox="175 464 537 741" style="list-style-type: none">❖ use a variety of familiar text forms and media in their own productions (e.g., recipes, comic strips, letters, radio or television reports, articles, tickets, time tables, itinerary) <p data-bbox="103 1073 526 1104">2.5.3 <i>Patterns of Social Interaction</i></p> <ul data-bbox="103 1129 542 1339" style="list-style-type: none">❖ combine simple social interaction patterns to perform transactions and interactions (e.g., invitation-acceptance/refusal with explanation)	<p data-bbox="605 506 1403 783">➤ After having reviewed a variety of newspaper and magazine articles, invite students to create their own article. Have students use a news story planner to help organize their ideas. The planner could include <i>Headline; Lead; Who? What? Where? When? Why? How? Ending; Quotable Quote</i> (Manitoba Education and Training, <i>Grades 5 to 8 English Language Arts: A Foundation for Implementation</i>, Grade 8 – 286).</p> <p data-bbox="605 1136 1403 1199">➤ Have students prepare a debate or formal discussion on a current event or issue.</p> <p data-bbox="605 1608 1403 1703">➤ Provide students with a scenario and instructions. Have students prepare role plays around travel situations such as haggling to buy something in a market.</p>



SUGGESTIONS FOR ASSESSMENT

SUGGESTED LEARNING RESOURCES

- When students write their own newspaper or magazine article, provide them with a checklist for self and peer assessment. Criteria might include the following:
 - specific purpose and audience are evident
 - headline is evident, clear
 - lead relates to main point and draws reader in
 - 6 W questions provide details to support main point
 - appropriate ending

Language Competence, Attend to Form Outcomes:

- verb tenses are used correctly, agreement of verbs/adjectives is correct
- spelling is correct

- When students prepare a debate, provide students with assessment criteria before they begin. Criteria might include the following:
 - clear message/opinion is given
 - opinions are supported with reasons/proof/details
 - language structures related to giving opinions are used effectively and appropriately (applications)
 - debate conforms to the standard structure

(See an example of debate assessment criteria in Planning, p. 94.)
- When students prepare role plays around travel situations, look for evidence that they are able to use interaction patterns typical for the context.

¡Dime! Dos
Unidad 3, Lección 3
pp. 164, 165

¡En español! 2
Unidad 2, Etapa 2

¡Buen Viaje! 2
Sección: Lecturas culturales

Planet@ 4
p. 46



Notes

*GLOBAL
CITIZENSHIP
YEAR 5*



Global Citizenship



study historical and contemporary elements of Spanish-speaking cultures

affirm diversity

Students will acquire the knowledge, skills, and attitudes to be effective global citizens, through the exploration of the cultures of the Spanish-speaking world.

explore personal and career opportunities



GLOBAL CITIZENSHIP

General Outcome 3: Students will acquire the knowledge, skills, and attitudes to be effective global citizens, through the exploration of the cultures of the Spanish-speaking world.

The outcomes for Global Citizenship deal with a broad range of knowledge, skills, and attitudes needed to be effective global citizens—in other words, with the development of intercultural competence. The concept of global citizenship encompasses citizenship at all levels, from the local school and community to Canada and the world.

The various components of global citizenship are grouped under three cluster headings—see the illustration on the preceding page. Under each of these headings there are several strands. Each strand deals with a single aspect of intercultural competence. For example, under the cluster heading **study historical and contemporary elements of Spanish-speaking cultures**, there are strands for the processes and methods of acquiring knowledge about Spanish-speaking cultures, the cultural knowledge thus acquired, applications of that knowledge to aid comprehension and to communicate in appropriate ways, positive attitudes toward Spanish-speaking cultures, as well as knowledge of the diversity within those cultures.

Developing cultural knowledge and skills is a lifelong process. Knowledge of one's own culture is acquired over a lifetime. Cultures change over time. Within any national group, there may be a dominant culture or cultures and a number of minority cultures. Rather than try to develop an extensive bank of knowledge about the Spanish-speaking cultures, it is more important for students to learn the processes and methods of accessing and analyzing cultural practices. Students will gain cultural knowledge in the process of developing these skills. In this way, if they encounter elements of the Spanish-speaking cultures they have not learned about in class, they will have the skills and abilities to deal with them effectively and appropriately.

The **affirm diversity** heading covers knowledge, skills, and attitudes that are developed as a result of bringing other languages and cultures into relationship with one's own. There is a natural tendency, when learning a new language and culture, to compare it with what is familiar. Many students leave a second language learning experience with a heightened awareness and knowledge of their own language and culture. They will also be able to make some generalizations about languages and cultures based on their experiences and those of their classmates who may have a variety of cultural backgrounds. This will provide students with an understanding of diversity within both a global and a Canadian context.



PRESCRIBED OUTCOMES	SUGGESTIONS FOR INSTRUCTION
<p>General Outcome 3: Global Citizenship</p> <p>Students will acquire the knowledge, skills, and attitudes to be effective global citizens through the exploration of the cultures of the Spanish-speaking world.</p> <p>3.1 study historical and contemporary elements of Spanish-speaking cultures</p> <p>3.1.1 <i>Access/Analyze Cultural Knowledge</i></p> <ul style="list-style-type: none">❖ make and test hypotheses about Spanish-speaking cultures❖ identify and use a variety of sources of information to find out about Spanish-speaking cultures <p>3.1.2 <i>Knowledge of Spanish-Speaking Cultures</i></p> <ul style="list-style-type: none">❖ explore and identify some elements of Spanish-speaking cultures (e.g., cultural values, attitudes and interests of people their own age from Spanish-speaking cultures)	<p>➤ Suggest that students work in groups to research famous artists from the Spanish-speaking world, using various sources to gather information (e.g., the Internet, CD-ROMs, books, newspaper and magazine articles). Have students highlight the characteristic styles and the historical contexts that may have influenced these artists. Ask students to collect this information in folders and share it with the class (<i>BC Resource Package, 64</i>).</p> <p>➤ Have students work in groups to report on media from the Spanish-speaking world (radio, TV, newspapers, magazines). Have students examine media reports from several countries on the same event and compare them to see</p> <ul style="list-style-type: none">• what information is included and what is left out• how media techniques are used to give a particular “slant” to a story (e.g., visuals, deadlines, emotionally loaded words, etc.)• what political affiliations might be influencing how the story is told, etc.



SUGGESTIONS FOR ASSESSMENT

SUGGESTED LEARNING RESOURCES

- Look for evidence that students are able to
 - identify and describe characteristic style or styles
 - identify historical elements that influenced the famous artist
 - explain how the historical elements influenced the life and works of the artist

- As students analyze media from the Spanish-speaking world, look for evidence that students
 - use a variety of sources and understand why this is necessary
 - identify similarities and differences between North American media and Hispanic media
 - identify key characteristics apparent in the media form studied (language competence, discourse)

¡En español! 2
pp. 282, 283

¡En español! 3
Unidad 1, Etapa 3, p. 92

¡Dime! Pasaporte al mundo 21
Unidad 1, Lección 3
Unidad 2, Lección 2
pp. 100, 101

¡Dime! Dos
Unidad 3, Lección 2
pp. 145–147
Unidad 5, Lección 3
pp. 269–273

¡Buen Viaje! 2
Capítulo 13, pp. 390, 391

Planet@ 3 and 4
Sección: Ruta literaria

¡En español! 2
Unidad 1, Etapa 3

¡Dime! Dos
Unidad 3, Lección 1, 2

¡Buen Viaje! 3
Capítulo 5, Periodismo



PRESCRIBED OUTCOMES	SUGGESTIONS FOR INSTRUCTION
<p>3.1 study historical and contemporary elements of Spanish-speaking cultures (continued)</p> <p>3.1.3 <i>Apply Cultural Knowledge</i></p> <ul style="list-style-type: none">❖ identify different perspectives on Spanish-speaking cultures and speculate on their origins (e.g., stereotypes of Spanish-speaking cultures present in their own community)	<ul style="list-style-type: none">➤ Provide students with examples of advertising from Spanish Internet sites, magazines, and/or TV commercials. In groups of four, have students identify the key meaning and terms for each example. Ask students to use what they know about the culture of the country of origin of the advertisement to interpret its meaning, using both the images and the words. Then ask students to compare their findings with similar advertising in Canada (e.g., clothing, soft drinks, automobiles, etc.). Each group then presents their analysis of the differences/similarities of significant terms in media and advertising between Canada and Spanish-speaking countries.
<p>3.1.4 <i>Diversity of Spanish-Speaking Cultures</i></p> <ul style="list-style-type: none">❖ identify different perspectives on diverse elements of Spanish-speaking cultures, and speculate on their origins (e.g., stereotypes within Spanish-speaking cultures)	<ul style="list-style-type: none">➤ Have students discuss influence of Spanish-speaking countries on North American music, food, literature, art, and architecture, and in their own community (BC <i>Resource Package</i>, 42).➤ Have students examine a world/current event in a Spanish-speaking country through several sources that represent different points of view and different groups in society.



SUGGESTIONS FOR ASSESSMENT

➤ When students analyze advertising, provide prompts to encourage students to reflect upon the meaning of culturally significant terms or images. Prompts could include the following:

- Key words used are _____
- Examples of the text reflecting the image(s) is _____
- Similarities with Canadian ads are _____
- Differences from Canadian ads are _____

Look for evidence that students are able to interpret the advertisement

- on a literal basis
- using connotations of words
- using images that would be suggestive to native speakers
- using idiomatic expressions

➤ When students discuss influence of Spanish-speaking countries on North American culture, look for evidence that students are able to

- identify elements of Spanish culture in North American culture
- draw a parallel between the two cultures
- understand/show awareness of similarities and differences

SUGGESTED LEARNING RESOURCES

¡En español! 3
p. T48

¡Dime! Dos
Unidad 3, Lección 2
pp. 130, 131, 135–137

¡Buen Viaje! 2
Capítulo 6
pp. 167, 171, 175

¡En español! 2
Unidad 1, pp. 90, 91
Unidad 2, p. 162
Unidad 5, p. 178

¡En español! 3
Unidad 1, Etapa 3, pp. 86, 92
Unidad 5, p.356

¡Dime! Dos
Sección: Impacto cultural
Leamos ahora

¡Buen Viaje! 2
Capítulo 2, 10

Imágenes de España
Imágenes de América Latina
Planet@ 3 and 4



PRESCRIBED OUTCOMES
<p>3.1 study historical and contemporary elements of Spanish-speaking cultures (continued)</p> <p>3.1.5 <i>Value Spanish-Speaking Cultures</i></p> <ul style="list-style-type: none">❖ examine their own perception of the language and culture, including stereotypes

SUGGESTIONS FOR INSTRUCTION

- Invite students to use maps and other relevant sources to identify the impact of Spanish exploration and immigration in North America. Then have them each select a topic for further research (e.g., food, religion, architecture). Encourage students to interview people who have travelled to this part of North America or to contact travel agents to gather information that would add to their presentations. Have students present reports in a variety of media and formats (BC *Resource Package*, 66).

- Brainstorm with the class a list of famous Spanish-speaking people (e.g. activists, athletes, artists, writers, etc.) and ask each student to select one person to research and then report to the class (BC *Resource Package*, 74).



SUGGESTIONS FOR ASSESSMENT

SUGGESTED LEARNING RESOURCES

- When students investigate and report on aspects of early Spanish exploration and immigration in North America, discuss assessment criteria before they begin their projects. Assessment criteria might include the following:
 - offers some insight and thoughtful speculation about contributions of Spanish-speaking cultures
 - bases conclusions and generalizations about contributions logically on the information presented
 - takes an open and objective stance that suggests respect for diversity
 - shows awareness of the complexity of cultural impact (e.g., avoids stereotyping)
 - provides thorough, relevant details and examples to add interest and illustrate key points

- Before students prepare reports on the contributions of Spanish-speaking individuals to their own countries and the world, discuss criteria such as the following:
 - focuses on the individual's accomplishments and contributions
 - shows insight into the context and importance of the contribution
 - information is accurate
 - uses relevant visual materials, music, or other features to elaborate the topic

- ¡En español! 3*
 Unidad 1, Etapa 1
 pp. 46, 47
- ¡Dime! Pasaporte al mundo 21*
 Sección: Del pasado al presente
- ¡Dime! Dos*
 Sección: Impacto cultural
- ¡Buen Viaje! 3*
 Capítulo 5, 8
- Imágenes de España*
Imágenes de América Latina
-
- ¡Dime! Pasaporte al mundo 21*
 Sección: Gente del mundo 21
- ¡Buen Viaje! 2, 3*
 Sección Literatura
- Imágenes de España*
Imágenes de América Latina



PRESCRIBED OUTCOMES	SUGGESTIONS FOR INSTRUCTION
<p>3.2 affirm diversity</p> <p>3.2.1 <i>Awareness of First Language</i></p> <ul style="list-style-type: none">❖ identify aspects of their personal style in both speech and writing <p>3.2.2 <i>General Language Knowledge</i></p> <ul style="list-style-type: none">❖ describe ways languages evolve over time and the reasons for their evolution <p>3.2.3 <i>Awareness of Own Culture</i></p> <ul style="list-style-type: none">❖ identify some of the past and present relationships between Spanish-speaking cultures being studied and their own (e.g., immigration, war) <p>3.2.4 <i>General Cultural Knowledge</i></p> <ul style="list-style-type: none">❖ recognize that different cultures may have different interpretations of texts, cultural practices, or products	<p>➤ Have students work in groups to analyze Spanish texts from media. Have them look for cognates, verb structures, proverbs, and idioms. Then have students make comparisons to their first language as well as to their own personal speaking and writing style.</p> <p>➤ Distribute two copies of a short text, one text in old Spanish and the other in modern Spanish. Have students compare the texts and the Spanish used. Have them identify the differences and discuss how the language has evolved.</p> <p>➤ Brainstorm with students a variety of elements that help define culture (e.g., clothing, sports, music, recreational activities, education, government, etc.). Have students work in small groups and choose one element of culture. Students identify ways in which their own culture and Spanish-speaking cultures are similar, based on their own knowledge and experience. Have students then research the cultural element they have chosen in order to support or refute their ideas.</p> <p>Students present their information in a visual and oral format, specifically identifying ways in which their own culture and Spanish-speaking cultures are similar.</p>



SUGGESTIONS FOR ASSESSMENT

SUGGESTED LEARNING RESOURCES

- As students analyze a variety of texts from the media, look for evidence that they are able to
 - identify cognates and common verb tenses used
 - make inferences about the meaning of idiomatic expression and/or proverbs
 - identify differences and similarities with the language of media in their own language

- When students analyze texts in old and modern Spanish, look for evidence that they are able to describe some key differences between the two versions.

- When students examine one element of culture in detail, discuss assessment criteria before they begin. Criteria might include the following:
 - similarities with own culture clearly identified
 - respect for diversity and differences in customs is evident
 - accurate and detailed information presented
 - information presented in an interesting/original manner
 - pronunciation and intonation are generally accurate (language competence, attend to form)

¡En español! 2
Unidad 1, Etapa 3

Planet@ 3 and 4
Sección: Glosario

¡Dime! Pasaporte al mundo 21
Unidad 2, Lección 1
pp. 83–88

¡Dime! Uno
Unidad 5, Lección 2

¡Dime! Dos
Unidad 1, Lección 2
Unidad 2, Lección 2
Unidad 8, Lección 1

¡Buen Viaje! 2, 3



PRESCRIBED OUTCOMES	SUGGESTIONS FOR INSTRUCTION												
<p>3.2 affirm diversity (continued)</p> <p>3.2.5 <i>Value Diversity</i></p> <ul style="list-style-type: none">❖ recognize and acknowledge the value of different perspectives <p>3.2.6 <i>Intercultural Skills</i></p> <ul style="list-style-type: none">❖ recognize stereotypical thinking	<p>➤ Have students research national heroes, writers, sports people, politicians, and/or artists. Have students identify their specific contributions to global society (e.g., Diego Rivera—Mexico, Salvador Dali—Spain, etc.).</p> <p>➤ Engage students in a brainstorming activity in which they identify words that they associate with or feel describe the people and their culture. For example:</p> <table data-bbox="698 997 1169 1260"><thead><tr><th>Mexicans</th><th>Canadians</th></tr></thead><tbody><tr><td><i>bajos</i></td><td><i>altos</i></td></tr><tr><td><i>morenos</i></td><td><i>rubios</i></td></tr><tr><td><i>amigables</i></td><td><i>muy amigables</i></td></tr><tr><td><i>prejuiciosos</i></td><td><i>indecisos</i></td></tr><tr><td><i>lentos</i></td><td><i>apurados</i></td></tr></tbody></table> <p>Have students discuss whether these are accurate descriptions or reflect stereotypes.</p>	Mexicans	Canadians	<i>bajos</i>	<i>altos</i>	<i>morenos</i>	<i>rubios</i>	<i>amigables</i>	<i>muy amigables</i>	<i>prejuiciosos</i>	<i>indecisos</i>	<i>lentos</i>	<i>apurados</i>
Mexicans	Canadians												
<i>bajos</i>	<i>altos</i>												
<i>morenos</i>	<i>rubios</i>												
<i>amigables</i>	<i>muy amigables</i>												
<i>prejuiciosos</i>	<i>indecisos</i>												
<i>lentos</i>	<i>apurados</i>												



SUGGESTIONS FOR ASSESSMENT

- When students research a specific Spanish-speaking figure and present his/her contributions to society, discuss criteria with students before they begin. Criteria might include the following:
 - individual's contributions to global society clearly identified
 - accurate and detailed information presented
 - appropriate vocabulary, verb tenses, and language structures used (language competence, attend to form)

- Observe students as they participate in the classroom. Identify which students are able to see the influences of stereotypes in the list created.

SUGGESTED LEARNING RESOURCES

¡Dime! Pasaporte al mundo 21
 Sección: Gente del mundo 21

¡Buen Viaje! 2, 3

Imágenes de España

Imágenes de América Latina

Planet@ 3 and 4



PRESCRIBED OUTCOMES	SUGGESTIONS FOR INSTRUCTION
<p>3.3 personal and career opportunities</p> <p>3.3.1 <i>Spanish Language and Spanish-Speaking Cultures</i></p> <ul style="list-style-type: none">❖ explore personal reasons for learning Spanish <p>3.3.2 <i>Cultural and Linguistic Diversity</i></p> <ul style="list-style-type: none">❖ explore personal reasons for learning additional languages and experiencing other cultures	<ul style="list-style-type: none">➤ Have students brainstorm professions, jobs, or activities in Canada for which a knowledge of Spanish would be relevant or useful. Following the brainstorming activity, in small groups, have students discuss their personal reasons for studying Spanish. ➤ Discuss with students ways in which they can use another language in the global marketplace. Examples might include telephone conversations, meetings, email, fax, etc. Provide students with opportunities to simulate business situations in which a second language would be necessary. Alternatively, have students make connections with world businesses via the Internet in order to apply their knowledge of a another language in a real setting.



SUGGESTIONS FOR ASSESSMENT

- Create an oral observation rubric appropriate for this task and record your assessment of individual students.
(See examples of oral observation criteria in Classroom Assessment, pp. 11 and 14.)

- Create an oral observation rubric appropriate for this task and record your assessment of individual students.
(See examples of oral observation criteria in Classroom Assessment, pp. 11 and 14.)

SUGGESTED LEARNING RESOURCES

¡En español! 2
Unidad 6, Etapa 1

¡Dime! Dos
Unidad 7, Lección 2, 3

Planet@ 3
Tema 1
Órbita 2
pp. 25–31



Notes

STRATEGIES
YEAR 5





Strategies

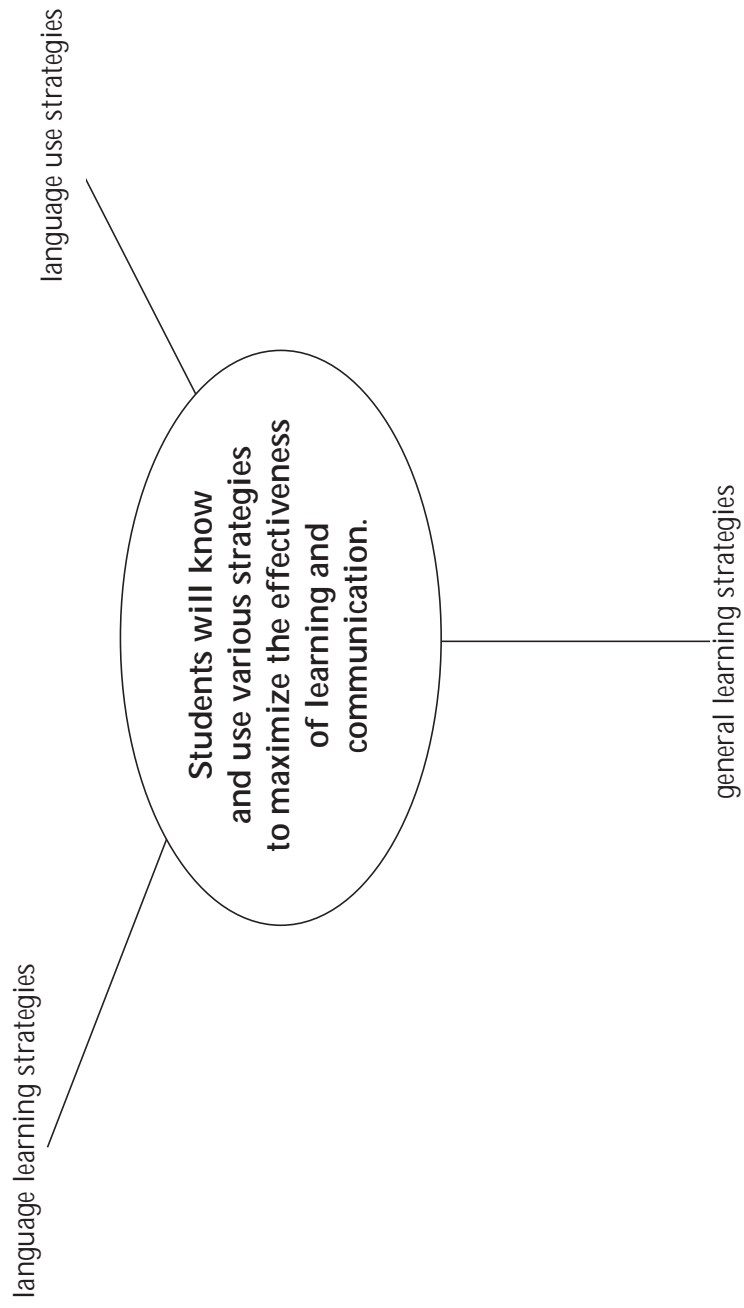



STRATEGIES

General Outcome 4: Students will know and use various strategies to maximize the effectiveness of learning and communication.

Under the Strategies heading are specific outcomes that will help students learn and communicate more effectively. Strategic competence has long been recognized as an important component of communicative competence. The outcomes that follow deal not only with compensation and repair strategies, important in the early stages of language learning when proficiency is low, but also with strategies for language learning, language use in a broad sense, as well as general learning strategies that help students acquire content. Although people may use strategies unconsciously, the outcomes deal only with the conscious use of strategies.

The strategies are grouped under three cluster headings—see the illustration on the preceding page. Under each of these headings there are several strands. Each strand deals with a specific category of strategy. Language learning and general learning strategies are categorized as cognitive, metacognitive, and social/affective. The language use strategies are organized by communicative mode: interactive, interpretive, and productive.

The strategies that students choose depend on the task they are engaged in as well as on other factors, such as their preferred learning style, personality, age, attitude, and cultural background. Strategies that work well for one person may not be effective for another person or may not be suitable in a different situation. For this reason it is not particularly useful to say that students should be aware of, or able to use, a specific strategy in a particular course. Consequently, the specific outcomes describe the students' knowledge of and ability to use general types of strategies. More specific strategies for each general category or type are included in the comprehensive list of strategies in Appendix E. The specific strategies provided in the comprehensive list are not prescriptive but are provided as an illustration of how the general strategies in the specific outcomes might be developed.

Teachers need to know and be able to demonstrate a broad range of strategies from which students are then able to choose in order to communicate effectively. Strategies of all kinds are best taught in the context of learning activities where students can apply them immediately and then reflect on their use.



PRESCRIBED OUTCOMES	SUGGESTIONS FOR INSTRUCTION
<p>General Outcome 4: Strategies Students will know and use various strategies to maximize the effectiveness of learning and communication.</p> <p>4.1 language learning strategies</p> <p>4.1.1 <i>Cognitive</i></p> <ul style="list-style-type: none">❖ select and use appropriate cognitive strategies to enhance language learning in a variety of situations (e.g., use word maps, mind maps, diagrams, charts, or other graphic representations to make information easier to understand and remember; find information using reference materials such as dictionaries, textbooks, and grammar references) <p>4.1.2 <i>Metacognitive</i></p> <ul style="list-style-type: none">❖ select and use appropriate metacognitive strategies to enhance language learning in a variety of situations (e.g., be aware of the potential of learning through direct exposure to the language, know how strategies may enable them to cope with texts containing unknown elements)	<p>➤ Before beginning a project, provide students with the opportunity to examine different reference materials. Have students work in groups. Provide each group with a different source of information to work with (e.g., dictionaries, textbooks, grammars, computer programs, etc.).</p> <p>Have each group respond to specific questions about the reference material to help students focus on the particular uses of the material. Then have each group prepare a poster which outlines the organization/specific uses of the reference material with which they worked. Students then report their findings to the class.</p> <p>➤ Provide students with a checklist of language acquisition strategies. Have students check the ones they have used and identify those they have found particularly useful (e.g., use visual clues to create context, listen for key words in a dialogue/conversation, watch gestures and body language to help decipher meaning, illustrate new vocabulary in a personal dictionary, use acronyms to help remember specific grammatical rules/structures, etc.).</p>



SUGGESTIONS FOR ASSESSMENT

SUGGESTED LEARNING RESOURCES

- When students work in groups to examine different resource materials, look for evidence that they are able to
 - explain how the material is organized
 - provide specific uses for material
 - suggest ways in which material can be used for specific projects
 - use a variety of reference materials when working on projects
 - use reference materials independently

- Have students write a learning log after they have completed the checklist. The learning log should identify methods that are useful to the students and why, as well as a new method that the student will try in the future.



PRESCRIBED OUTCOMES	SUGGESTIONS FOR INSTRUCTION
<p>4.1 language learning strategies (continued)</p> <p>4.1.3 <i>Social/Affective</i></p> <ul style="list-style-type: none">❖ select and use appropriate social and affective strategies to enhance language learning in a variety of situations (e.g., repeat new words and expressions that occur in conversations in which they participate, make use of them as soon as appropriate)	<p>➤ Have students work in groups of three to prepare a skit about studying abroad and looking for an apartment. Three scenes could be included:</p> <ol style="list-style-type: none">1. Preparing for a trip abroad2. Registration, getting familiarized3. Looking for an apartment <p>Have students pretend that one person in the presentation has trouble with Spanish and have students repeat important expressions several times throughout the presentation. Have students in the audience note the repeated expressions.</p> <p>Have students then discuss the effectiveness of repetition of expressions as a communication strategy.</p>
<p>4.2 language use strategies</p> <p>4.2.1 <i>Interactive</i></p> <ul style="list-style-type: none">❖ select and use appropriate interactive strategies in a variety of situations (e.g., repeat part of what someone has said to confirm mutual understanding)	<p>➤ Show students a TV interview. Have them note and then interpret the fillers, hesitation devices, etc. used during the interview. Then have students each prepare five questions that they could ask a classmate about a current event or issue. Students then work in pairs to interview each other, paying special attention to fillers, hesitation devices, and circumlocution used. Alternatively, two students at a time could be asked to interview each other in front of the class.</p>



SUGGESTIONS FOR ASSESSMENT

SUGGESTED LEARNING RESOURCES

- When students prepare skits about studying abroad, provide assessment criteria before they begin. Look for evidence that they are able to
 - use and emphasize new vocabulary and structures
 - sustain interactions using a variety of strategies (e.g., body language, rephrasing or repeating information, asking questions)
 - respond appropriately to questions and cues from others

- As students prepare questions and interview a classmate, look for evidence that they are able to
 - formulate appropriate questions
 - use fillers and hesitation devices during interview
 - speak clearly, with accurate pronunciation and intonation (language competence, attend to form)

¡En español! 2
 Unidad 4, Etapa 1, p. 244
 Unidad 4, Etapa 2, p. 266

¡Dime! Pasaporte al mundo 21
 Unidad 1, Lección 3
 pp. 66, 69

¡Dime! Dos
 Unidad 3, Lección 1
 pp. 112, 113, 117–120



PRESCRIBED OUTCOMES	SUGGESTIONS FOR INSTRUCTION
<p>4.2 language use strategies (continued)</p> <p>4.2.2 <i>Interpretive</i></p> <ul style="list-style-type: none">❖ select and use appropriate interpretive strategies in a variety of situations (e.g., reread several times to understand complex ideas) <p>4.2.3 <i>Productive</i></p> <ul style="list-style-type: none">❖ select and use appropriate productive strategies in a variety of situations (e.g., use a variety of resources to correct texts)	<p>➤ Provide students with a guide to help them in skimming of non-fiction material encountered during study of the media (Manitoba Education and Training, <i>Grades 5 to 8 English Language Arts: A Foundation for Implementation</i>, Grade 5 – 244):</p> <ol style="list-style-type: none">1. Read the title and the first paragraph, and last paragraph or summary.2. Read all the bold print headings, sub-headings, and captions.3. Read the first sentence of each paragraph.4. If the first sentence does not have the main idea, quickly move your eyes to the end of the paragraph and read the last sentence.5. Reread the heading, then move through the paragraph looking for bold print, italics, names, dates, or key words on the topic.6. After skimming all the paragraphs in the selection, read the last paragraph of the selection again. <p>➤ Have students work in pairs. One student reads a portion of an article out loud while the other student takes notes. Have students then change roles, continuing the reading-note-taking cycle until the article is completed. Have students rewrite the article and then verify their article with the original article for accuracy.</p> <p>Have students first review their own texts with the help of Spanish dictionaries and verb books. Then have a classmate edit the text. Students then correct their texts and either submit them to another classmate or the teacher for a final editing. Students then prepare the final copy of their text.</p>



SUGGESTIONS FOR ASSESSMENT

SUGGESTED LEARNING RESOURCES

- Provide students with a checklist for self assessment of skimming strategies, based on guideline provided. Look for evidence that students are able to
 - focus on key words, phrases
 - use bold print, italics, etc. to find information

¡En español! 2
Unidad 1, Etapa 3

¡Dime! Pasaporte al mundo 21
Sección: Ventana al mundo 21

¡Buen Viaje! 3
Sección periodismo

- As students work in pairs to take notes based on an article, look for evidence that they are able to
 - focus on key words and phrases
 - listen attentively/actively to partner
 - make accurate modifications to notes during verification
 - use their notes to reproduce article accurately in written form
- As students edit their work, look for evidence that they are
 - using a variety of resources
 - editing with increasing frequency and ease

¡En español! 2
Unidad 1, Etapa 3

¡Dime! Pasaporte al mundo 21
Sección: Ventanas al mundo 21

¡Buen Viaje! 3
Sección periodismo

Planet@ 3 and 4
Sección: Ruta literaria



PRESCRIBED OUTCOMES	SUGGESTIONS FOR INSTRUCTION
<p>4.3 general learning strategies</p> <p>4.3.1 <i>Cognitive</i></p> <ul style="list-style-type: none">❖ select and use a variety of cognitive strategies to enhance general learning (e.g., formulate key questions to guide research) <p>4.3.2 <i>Metacognitive</i></p> <ul style="list-style-type: none">❖ select and use a variety of metacognitive strategies to enhance general learning (e.g., keep a learning journal such as a diary or a log) <p>4.3.3 <i>Social/Affective</i></p> <ul style="list-style-type: none">❖ select and use a variety of social and affective strategies to enhance general learning (e.g., take part in group problem-solving processes)	<p>➤ Provide students with a planning guide to help them formulate key questions/ideas for a research project. A sample guide could include the following (Manitoba Education and Training, <i>Grades 5 to 8 English Language Arts: A Foundation for Implementation</i>, Grade 8 – 182):</p> <ul style="list-style-type: none">• Name, Date, Topic• What questions do I want to answer?• In what resources am I likely to find information?• How will I record my information?• How will I give credit to my sources?• How will I share my findings with the class?• How will I assess my work? <p>(See an example of a planning guide in Planning, p. 67.)</p> <p>➤ Have students keep a learning log. Provide students with questions such as the following (Manitoba Education and Training, <i>Grades 5 to 8 English Language Arts: A Foundation for Implementation</i>, Grade 8 – 38):</p> <ul style="list-style-type: none">• What did I understand about the work I did today?• How did I relate what I already knew with new information?• How have my ideas changed?• What did I not understand?• What questions do I still have?• How could I find answers to my questions? <p>(See an example of questions for a reflective log in Planning, p. 89.)</p> <p>➤ As students work in groups to prepare projects, have them identify different ways in which problems can be solved. Have students solve a problem based on one or more ways chosen by the group.</p>



Notes

YEAR 6

Applications	3
Language Competence	21
Global Citizenship	49
Strategies	65

APPLICATIONS
YEAR 6



Applications

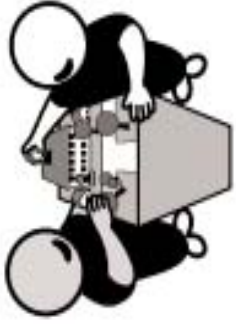

express emotions and personal perspectives

impart and receive information

get things done

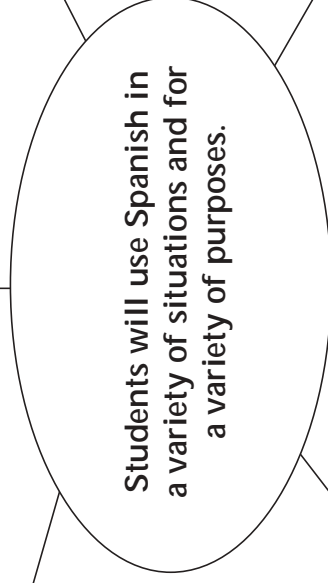

use the language for imaginative purposes and personal enjoyment

form, maintain, and change interpersonal relationships

extend their knowledge of the world



APPLICATIONS

General Outcome 1: Students will use Spanish in a variety of situations and for a variety of purposes.

The specific outcomes under the heading Applications deal with **what** the students will be able to do with the Spanish language, that is, the **functions** they will be able to perform and the **contexts** in which they will be able to operate. This functional competence, also called actional competence, is important for a content-based or task-based approach to language learning where students are constantly engaged in meaningful tasks (Celce-Murcia, Dörnyei, and Thurrell).

The functions are grouped under six cluster headings—see the illustration on the preceding page. Under each of these headings, there are one or more strands. Each strand deals with a specific language function (e.g., share factual information). Students at any grade level will be able to share factual information. Beginning learners will do this in very simple ways (e.g., “This is my dog.”). As students gain more knowledge and experience, they will broaden the range of subjects they can deal with, they will learn to share information in writing as well as orally, and they will be able to handle formal and informal situations.

Different models of communicative competence have organized language functions in a variety of ways. The organizational structure chosen here reflects the needs and interests of students in a classroom where activities are focused on meaning and are interactive. For example, the strand entitled **manage group actions** has been included to ensure that students acquire the language necessary to function independently in small groups, since this is an effective way of organizing second language classrooms. The strands under the cluster heading **to extend their knowledge of the world** will accommodate a content-based approach to language learning where students learn content from another subject area as they learn the Spanish language.

The level of linguistic, sociolinguistic, and discourse competence that students will exhibit when carrying out the functions is defined in the specific outcomes for Language Competence for each course. To know how well students will be able to perform the specific function, the Applications outcomes must be read in conjunction with the Language Competence outcomes.



PRESCRIBED OUTCOMES	SUGGESTIONS FOR INSTRUCTION
<p>General Outcome 1: Applications Students will use Spanish in a variety of situations and for a variety of purposes.</p> <p>1.1 impart and receive information</p> <p>1.1.1 <i>Share Factual Information</i></p> <ul style="list-style-type: none">❖ share detailed information on a specific topic (e.g., a report or biography)	<ul style="list-style-type: none">➤ Have students in small groups identify ways they could help improve the environment by assessing their own lifestyles and actions. Ask groups to share their ideas and incorporate them into a letter-writing campaign (perhaps to one institution) aimed at promoting a healthy environment. Students could send their letter by email, fax, or mail (<i>BC Resource Package, 68</i>).<p><i>Variation:</i> Instead of writing a letter to an institution, do a letter exchange with peers, either Spanish-speaking or other Spanish learners. Or, write a letter to a Spanish editor of a Spanish magazine or newspaper.</p> <ul style="list-style-type: none">➤ Suggest that students examine employment advertisements in Spanish-language newspapers as well as look at various publications designed to help young people find part-time and summer employment. Using information from these sources and a class discussion about part-time jobs, students could then work to identify the information they need to find and secure part-time employment (<i>BC Resource Package, 54</i>).➤ Ask students to set up budgets for the first year after grade 12. Then have them form groups and discuss how they allocated money for expenses such as tuition, rent, groceries, furnishings, and transportation. Alternatively, have students prepare a budget for studying abroad, taking into consideration expenses such as flight, tuition, accommodations, groceries, transportation, books, etc. (<i>BC Resource Package, 68</i>).



SUGGESTIONS FOR ASSESSMENT

SUGGESTED LEARNING RESOURCES

- When students examine issues such as the environment, look for evidence of the extent to which they
 - take positions and make their views clear
 - give relevant reasons and examples to support their arguments
 - listen actively and attempt to respond to or build on others' ideas

- When students look at job opportunities, look for evidence that they are able to
 - locate factual information
 - discuss information and identify key information

- When students prepare budgets and then discuss in groups, look for evidence that they
 - express their opinions clearly and justify them with examples
 - exchange ideas with peers
 - listen actively to peers
 - use target vocabulary and expressions appropriately

¡En español! 2
Unidad 5, Etapa 1, 2, 3

¡Buen Viaje! 2
pp. 322, 323

¡Buen Viaje! 3
pp. 322–326

<www.usuarios.lycos.es/medam20/>

¡En español! 2
Unidad 6, Etapa 1
p. 338

¡Dime! Dos
Unidad 7, Lección 2, 3

¡Buen Viaje! 2
Capítulo 14

¡En español! 3
Unidad 3, Etapa 1
p. 174



PRESCRIBED OUTCOMES	SUGGESTIONS FOR INSTRUCTION
<p>1.2 express emotions and personal perspectives</p> <p>1.2.1 <i>Share Ideas, Thoughts, Opinions, Preferences</i></p> <ul style="list-style-type: none">❖ express opinions❖ support their own opinions	<ul style="list-style-type: none">➤ Have students prepare a debate on topics such as ONU, NAFTA. Possible key questions might include <i>¿Cómo será el mundo?</i>➤ Have students form two groups and prepare a debate on the following question: <i>¿El mundo será mejor o peor en 100 años?</i> <p>One group would defend the notion that the world will be a better place and one group would defend the notion that the world will be a worse place to live in 100 years.</p>
<p>1.2.2 <i>Share Emotions, Feelings</i></p> <ul style="list-style-type: none">❖ compare the expression of emotions and feelings in formal and informal situations	<ul style="list-style-type: none">➤ Have students read several poems. Students then choose two poems that reflect contrasting emotions and recite them in small groups. Students should use gestures and facial expressions which express the emotions evoked in the poems.
<p>1.3 get things done</p> <p>1.3.1 <i>Guide Actions of Others</i></p> <ul style="list-style-type: none">❖ lodge a complaint❖ persuade others to take a course of action	<ul style="list-style-type: none">➤ Have students work in groups to prepare two role plays. Each group will have a leader to oversee the conversations. <p>Role Play #1—Each group member is the member of a family that is discussing the son's/daughter's plans after graduation (informal).</p> <p>Role Play #2—The son/daughter is at a formal interview. Each group member is a part of the interview process (formal).</p> <p><i>Alternative:</i> Stay in a hotel. Something is wrong with your room. Complain to the desk clerk (formal).</p>



SUGGESTIONS FOR ASSESSMENT

SUGGESTED LEARNING RESOURCES

- When students prepare a debate, discuss assessment criteria before they begin. Criteria might include the following:
 - accurate and detailed information is presented
 - appropriate use of formal language/register (language competence, sociocultural context)
 - language structures (vocabulary/expressions) are used appropriately (language competence, attend to form)
 - pronunciation and intonation are generally accurate (language competence, attend to form)
 (See criteria for debate assessment in Planning, pp. 94–95.)

- Look for evidence that students are able to guide their conversation and actions in both a formal and informal situation.

(See role-play assessment criteria in Classroom Assessment, p. 11.)

¡En español! 2
Unidad 6, Etapa 1

¡Dime! Dos
Unidad 7, Lección 2, 3

¡Buen Viaje! 2
Capítulo 14



PRESCRIBED OUTCOMES	SUGGESTIONS FOR INSTRUCTION
<p>1.3 get things done (continued)</p> <p>1.3.2 <i>State Personal Actions</i></p> <ul style="list-style-type: none">❖ express possibility in relation to their own actions and plans <p>1.3.3 <i>Manage Group Actions</i></p> <ul style="list-style-type: none">❖ take on a leadership role in small group projects	<ul style="list-style-type: none">➤ Have students prepare a list of career interests and have them consider the following key questions: <i>¿Dónde estarás en 5 años? ¿Que cumplirás en 5 años?</i> <ul style="list-style-type: none">➤ Have students prepare a mock UN conference. Have students form groups or work in pairs, with each group representing a different Spanish-speaking country. Each group presents the problems/concerns of its countries and together the whole group finds solutions. <ul style="list-style-type: none">➤ Have students prepare a mock parliament session in which current issues related to Spanish-speaking countries would be discussed (e.g., NAFTA, relations with Spanish-speaking countries, etc.).



SUGGESTIONS FOR ASSESSMENT

- As students consider their futures in the context of career interests, look for evidence that they
 - express their plans and ideas with ease
 - explain their predictions
 - use future tense appropriately (language competence, attend to form)

Look for evidence that students show leadership skills when presenting their concerns on behalf of their countries, such as the following:

- presenting on behalf of their group
- keeping the group on task
- participation, collaboration, and interaction are clearly evident throughout activity

- When students prepare a mock UN conference, discuss assessment criteria before they begin. Criteria might include the following:
 - accurate and detailed information is presented
 - language structures (vocabulary and expressions) are used appropriately (language competence, attend to form)
 - pronunciation and intonation are generally accurate throughout presentation (language competence, attend to form)
- When students prepare a mock parliament, use same criteria as that of UN conference.

SUGGESTED LEARNING RESOURCES

¡En español! 2

Unidad 5, Etapa 1
Etapa 3, pp. 376, 377

¡Dime! Pasaporte al mundo 21

Sección: Pasado al presente

¡Buen Viaje! 2

Capítulo 5, pp. 213–215
Capítulo 8, p. 365

¡En español! 2

Unidad 5, Etapa 1
Etapa 3, pp. 376, 377

¡En español! 2

Unidad 5, Etapa 1, 3

¡En español! 3

Unidad 2, Etapa 1



PRESCRIBED OUTCOMES	SUGGESTIONS FOR INSTRUCTION
<p>1.4 extend their knowledge of the world</p> <p>1.4.1 <i>Discover and Explore</i></p> <ul style="list-style-type: none">❖ explore connections and gain new insights into familiar topics (e.g., using analogy, brainstorming) <p>1.4.2 <i>Gather and Organize Information</i></p> <ul style="list-style-type: none">❖ identify key ideas, summarize, and paraphrase <p>1.4.3 <i>Solve Problems</i></p> <ul style="list-style-type: none">❖ apply problem-solving skills to the resolution of a real-life problem <p>1.4.4 <i>Explore Opinions and Values</i></p> <ul style="list-style-type: none">❖ understand the concept of stereotype, and recognize stereotyping in a variety of situations	<p>➤ As an introduction to current issues, brainstorm a list of current issues. Have students choose an issue and create a web of their knowledge of the issue. Then have students work in groups to compare their understanding of the issue with that of classmates.</p> <p>➤ In preparation for a debate, have students find information about their topic/issue from a variety of sources. Have students evaluate the usefulness and reliability of the sources and incorporate relevant information into the debate.</p> <p>➤ Brainstorm or provide students with a list of conflicts/problems they may encounter in looking for a job or in looking for accommodations while living abroad. Have students work in pairs to role-play one of these problems and offer a solution.</p> <p>➤ Have students examine a current issue such as world pollution. Have students work in groups to each gather information about a different Spanish-speaking country and the current problems related to pollution that exist in that country. Invite students to also include the consequences of these problems as well as possible solutions.</p> <p>A key question to include might be <i>¿Cómo será el mundo? Si— _____</i>. Have students work with the <i>Si</i> clause in relation to this topic. As an extension, students could prepare an ad campaign/commercial promoting recycling or other solutions to problems of pollution.</p> <p>➤ Have students review a Spanish newspaper, magazine, or website. Ask them to look for evidence of stereotypes in the articles, visuals, or advertisements. In a large group setting, ask students to share their findings.</p>



SUGGESTIONS FOR ASSESSMENT

SUGGESTED LEARNING RESOURCES

- Look for evidence that students are able to
 - express their understanding
 - compare their insights with those of classmates

- Look for evidence that students are able to
 - locate information from a variety of sources
 - choose information from sources that are useful and relevant

- Look for evidence that students are able to
 - clearly identify a problem
 - develop a logical solution

- When students examine current issues such as world pollution, look for evidence that they
 - present accurate information
 - present problems and their reasons/consequences
 - use *si* clause with conditional correctly (language competence, attend to form)

- Look for evidence that students are able to identify at least one or two relevant examples.

¡En español! 2
Unidad 5, Etapa 3
p. 360

¡En español! 3
Unidad 2, Etapa 2
p. 126

¡Buen Viaje! 2
pp. 322, 323

¡Buen Viaje! 3
pp. 322–326



PRESCRIBED OUTCOMES
<p>1.5 imaginative purposes and personal enjoyment</p> <p>1.5.1 <i>Humour/Fun</i></p> <ul style="list-style-type: none">❖ use language for fun and to interpret and express humour (e.g., humourous or editorial cartoons, stories, poems) <p>1.5.2 <i>Creative/Aesthetic Purposes</i></p> <ul style="list-style-type: none">❖ use the language creatively and for aesthetic purposes (e.g., write new words to a known melody or create a rap)

SUGGESTIONS FOR INSTRUCTION

- Provide students with an editorial cartoon related to a current or social issue. Have students create a short skit that illustrates their understanding/interpretation of the cartoon. Have students include some idiomatic expressions in their skit.

- Provide students with a literary piece (play, poem, story) and have them rewrite it in the form of script and dramatize it.

- Ask students to listen to poems in Spanish and then represent them in dramatizations or illustrations (BC *Resource Package*, 24).



SUGGESTIONS FOR ASSESSMENT

SUGGESTED LEARNING RESOURCES

- When students create a short skit based on an editorial cartoon, look for evidence that they
 - understand and interpret the humour of the cartoon appropriately
 - use vocabulary and idiomatic expressions correctly
 - use good oral expression (clarity, pronunciation, fluency) (language competence, attend to form)

- When students re-create plays, look for evidence that they are able to
 - interpret the feelings, ideas, and themes of the original work
 - create appropriate dialogue
 - incorporate detail to engage the audience
 - show evidence of practice and rehearsal (fluency, sense of ease) in their presentations (language competence, attend to form)

- When students dramatize or illustrate poems, look for evidence that they are
 - trying to interpret the mood of the poem
 - engaged in the task
 - interested in sharing their work with others

Internet

¡Dime! Pasaporte al mundo 21

¡Dime! Uno
Unidad 5, Lección 3

¡En español! 2
Unidad 5, Etapa 3
pp. 376, 377

¡Buen Viaje! 2
Literatura, pp. 430–447

¡Buen Viaje! 3
Sección de literatura
Cada capítulo

¡En español! 2
Unidad 6, Etapa 3, pp. 448, 449

¡En español! 3
Unidad 3, Etapa 1, pp. 190, 191
Unidad 3, Etapa 3, pp. 234, 235

¡Buen Viaje! 3
Capítulo 1, pp. 44–51
Capítulo 2, pp. 92–95
Capítulo 3, pp. 140–144
Capítulo 4, pp. 194–199
Capítulo 5, pp. 239–243
Capítulo 8, pp. 395–397
pp. 404–407



PRESCRIBED OUTCOMES	SUGGESTIONS FOR INSTRUCTION
<p>1.5 imaginative purposes and personal enjoyment (continued)</p> <p>1.5.3 <i>Personal Enjoyment</i></p> <ul style="list-style-type: none">❖ use the language for personal enjoyment (e.g., keep a personal journal)	<ul style="list-style-type: none">➤ Have students participate in improvisation with the vocabulary, verbs, and themes studied. Students work in pairs or in groups of three. Provide each group with a theme, three key vocabulary words, and three important verbs encountered in the theme. Each group receives different vocabulary and verbs. Students then have 15 minutes to prepare a situation related to the theme given and integrating the vocabulary and verbs into the situation. ➤ Have students play a variety of games similar to the following:<ul style="list-style-type: none">• “Jeopardy”—Questions are related to the themes studied.• “Trivia”—¿<i>Quién quiere ser millonario?</i> (Categories: history, current issues, literature, etc.) Let students create a name for their game.



SUGGESTIONS FOR ASSESSMENT

**SUGGESTED LEARNING
RESOURCES**

- When students participate in improvisation activities with vocabulary and verbs studied, look for evidence that
 - participation and interaction is evident, with students adding to/building on ideas of others
 - audience is engaged
 - vocabulary and verbs are used appropriately (language competence, attend to form)
 - interaction has some sense of spontaneity and fluency (language competence, interactive fluency)

- When students participate in games or improvisation, look for evidence that they are able to participate willingly.



PRESCRIBED OUTCOMES	SUGGESTIONS FOR INSTRUCTION
<p>1.6 form, maintain, and change interpersonal relationships</p> <p>1.6.1 <i>Manage Personal Relationships</i></p> <ul style="list-style-type: none">❖ offer and respond to congratulations, and express sympathy or regret	<ul style="list-style-type: none">➤ Have students take turns in acting as the emcee or moderator for classroom presentations, debates, or guest speakers. ➤ When working in small groups, take time before the activity to focus on collaborative skills. Have students complete a checklist, evaluating their group members' contributions. A discussion will follow where group members offer suggestions and clarify misunderstanding, as well as offer and respond to congratulations.



SUGGESTIONS FOR ASSESSMENT

- After the activity or event has ended, ask the student acting as moderator or emcee to reflect on their performance and record their thoughts in their learning log or journal.
- Observe that students are able to suggest ideas and clarify misunderstandings to handle conflict situations.

SUGGESTED LEARNING RESOURCES

--



Notes

*LANGUAGE
COMPETENCE
YEAR 6*



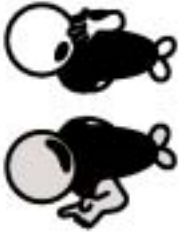

Language Competence

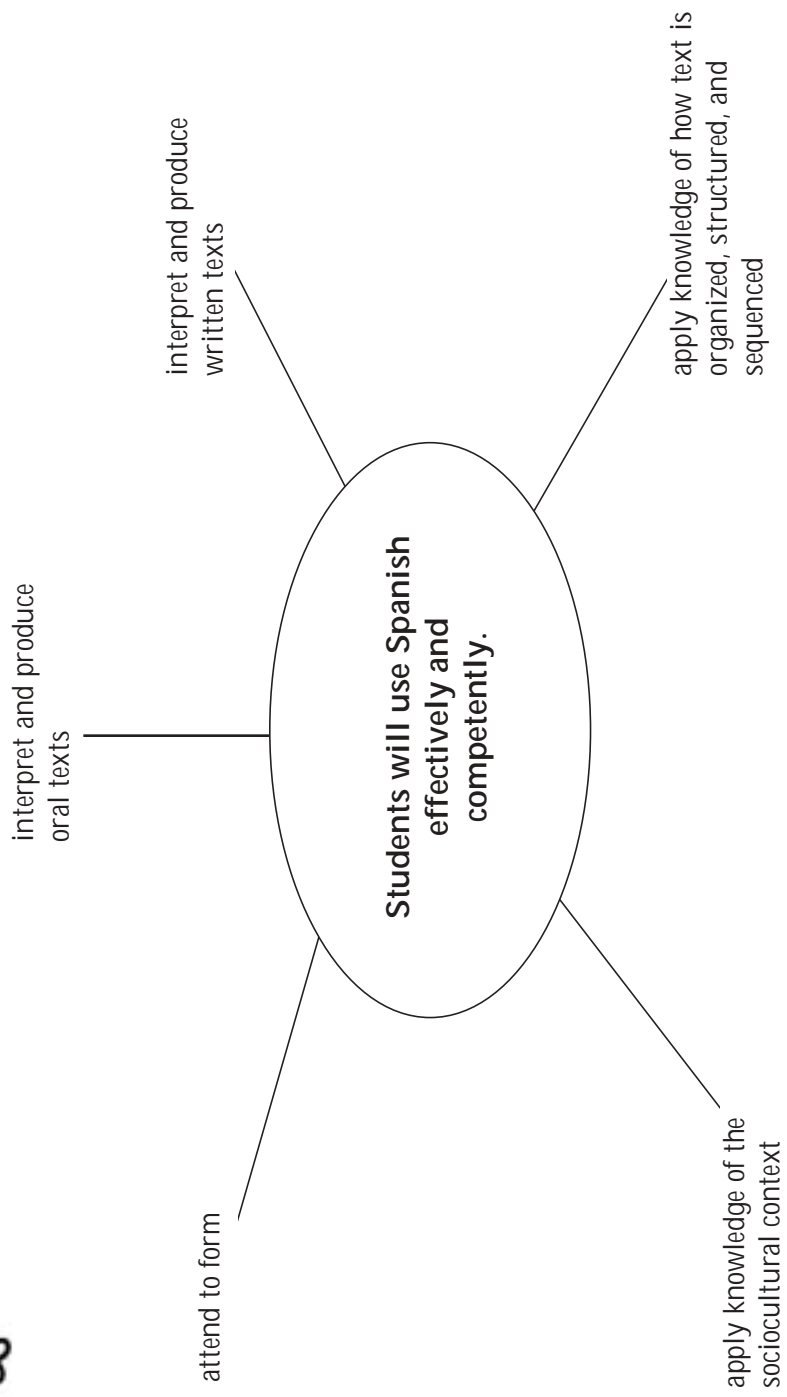



LANGUAGE COMPETENCE

General Outcome 2: Students will use Spanish effectively and competently.

Language competence is a broad term that includes linguistic or grammatical competence, discourse competence, sociolinguistic or sociocultural competence, and what might be called textual competence. The specific outcomes under Language Competence deal with knowledge of the Spanish language and the ability to use that knowledge to interpret and produce meaningful texts appropriate to the situation in which they are used. Language competence is best developed in the context of activities or tasks where the language is used for real purposes, in other words, in practical **applications**.

The various components of language competence are grouped under four cluster headings—see the illustration on the preceding page. Under each of these headings there are several strands. Each strand deals with a single aspect of language competence. For example, under the cluster heading **attend to form**, there is a strand for phonology (pronunciation, stress, intonation), orthography (spelling, mechanical features), lexicon (vocabulary words and phrases), and grammatical elements (syntax and morphology).

Although the outcomes isolate these individual aspects, language competence should be developed through learning activities that focus on meaningful uses of the Spanish language and on **language in context**. Tasks will be chosen based on the needs, interests, and experiences of students. The vocabulary, grammar structures, text forms, and social conventions necessary to carry out a task will be taught, practised, and assessed as students are involved in various aspects of the task itself, **not in isolation**.

Strategic competence is often closely associated with language competence, since students need to learn ways to compensate for low proficiency in the early stages of learning if they are to engage in authentic language use from the beginning. This component is included in the language use strategies in the Strategies section.



PRESCRIBED OUTCOMES	SUGGESTIONS FOR INSTRUCTION
<p>General Outcome 2: Language Competence Students will use Spanish effectively and competently.</p> <p>2.1 attend to form</p> <p>2.1.1 <i>Phonology</i></p> <ul style="list-style-type: none">❖ speak clearly and intelligibly in a variety of situations <p>2.1.2 <i>Orthography</i></p> <ul style="list-style-type: none">❖ recognize and correctly spell familiar words (e.g., sight words)❖ apply basic spelling rules consistently and use mechanical conventions with reasonable accuracy	<ul style="list-style-type: none">➤ Model correct pronunciation with every oral activity.➤ Provide students with many opportunities to practice their oral production in pairs or in small groups. ➤ Provide students with opportunities to independently edit and peer edit written work.



SUGGESTIONS FOR ASSESSMENT

**SUGGESTED LEARNING
RESOURCES**

- Observe that students produce the sounds, stress, rhythm, and intonation patterns of Spanish on a regular basis.

- Look for evidence that students' spelling and punctuation are accurate in a variety of texts.



PRESCRIBED OUTCOMES
<p>2.1 attend to form (continued)</p> <p>2.1.3 <i>Lexicon</i></p> <ul style="list-style-type: none">❖ use a repertoire of words and phrases in familiar contexts that meet the needs and interests of students, particularly within the following areas of experience:<ul style="list-style-type: none">— literature<ul style="list-style-type: none">✓ poetry✓ contemporary Spanish writers— future plans— careers— studying/living abroad<ul style="list-style-type: none">✓ accommodations— looking for an apartment— history— current issues— globalization/globalism❖ select vocabulary and expressions from within their repertoire to fulfill a variety of purposes in a variety of contexts

SUGGESTIONS FOR INSTRUCTION



SUGGESTIONS FOR ASSESSMENT

**SUGGESTED LEARNING
RESOURCES**

--	--



PRESCRIBED OUTCOMES	SUGGESTIONS FOR INSTRUCTION
<p>2.1 attend to form (continued)</p> <p>2.1.4 <i>Grammatical Elements</i></p> <ul style="list-style-type: none">❖ use, in modelled situations, the following grammatical elements:<ul style="list-style-type: none">— pluperfect tense— passive voice— indicative or subjunctive with relative pronouns, for example:<ul style="list-style-type: none">✓ <i>Conozco a alguien que habla español.</i>✓ <i>Busca a alguien que hable español.</i>— imperfect subjunctive + conditional (<i>si</i> clauses)	<p>Modelled Situations: This term is used to describe learning situations where a model of specific grammatical elements is consistently provided and immediately available. Students in such situations will have an emerging awareness of the grammatical elements and be able to apply them in very limited situations. Limited fluency and confidence characterize student language.</p> <p>Example of a modelled situation:</p> <p>In preparation for a group project, students will keep a journal of their daily activities for a week. Students practise the structure " <i>tener que</i> + infinitive " using the sentence patterns provided. Each student asks five classmates, <i>¿Qué tienes que hacer después de clases hoy?</i> Students answer saying, <i>Tengo que . . .</i>, with an infinitive of their choice. Each person then summarizes the results of their mini survey, <i>Tres estudiantes tienen que estudiar</i>, and so on.</p>



SUGGESTIONS FOR ASSESSMENT

**SUGGESTED LEARNING
RESOURCES**

SUGGESTIONS FOR ASSESSMENT	SUGGESTED LEARNING RESOURCES



PRESCRIBED OUTCOMES	SUGGESTIONS FOR INSTRUCTION
<p>2.1 attend to form (continued)</p> <p>2.1.4 <i>Grammatical Elements</i></p> <ul style="list-style-type: none">❖ use, in structured situations, the following grammatical elements:<ul style="list-style-type: none">— future tense— conditional mood— subjunctive mood— present subjunctive:<ul style="list-style-type: none">✓ to express wishes and hope: <i>Ojalá que ..., quiero que</i>✓ to express emotion: <i>alegrarse, sentir ...</i>✓ to express persuasion: <i>aconsejar, decir, desear, pedir</i>✓ after impersonal expressions: <i>es una lástima que ..., es necesario que ...</i>✓ to express doubt✓ after <i>cuando</i> and <i>aunque</i>— impersonal verb form with <i>se</i>	<p>Structured Situations: This term is used to describe learning situations where a familiar context for the use of specific grammatical elements is provided and students are guided in their use. Students in such situations will have increased awareness and emerging control of the grammatical elements and be able to apply them in familiar contexts with teacher guidance. Student language is characterized by increasing fluency and confidence.</p> <p>Example of a structured situation:</p> <p>In preparation for a research project on typical activities of young people in selected Spanish-speaking countries, students listen to a rapid conversation where a Canadian student is talking to an exchange student from Mexico. The students check off, on a prepared answer sheet, what the exchange student does and does not do.</p>



SUGGESTIONS FOR ASSESSMENT

**SUGGESTED LEARNING
RESOURCES**

SUGGESTIONS FOR ASSESSMENT	SUGGESTED LEARNING RESOURCES



PRESCRIBED OUTCOMES	SUGGESTIONS FOR INSTRUCTION
<p>2.1 attend to form (continued)</p> <p>2.1.4 <i>Grammatical Elements (continued)</i></p> <ul style="list-style-type: none">❖ use, in independent situations, the following grammatical elements:<ul style="list-style-type: none">— possessive pronouns: <i>mío, tuyo, suyo, míos, tuyos, suyos</i>— indirect object pronouns— double object pronouns— preterite tense (irregular verbs)— imperfect tense— preterite tense vs. imperfect tense— comparative, superlative, and diminutive	<p>Independent Situations: This term is used to describe learning situations where students use specific grammatical elements in a variety of contexts with limited teacher guidance. Students in such situations will have consistent control of the grammatical elements and be able to apply them in a variety of contexts with limited teacher guidance. Fluency and confidence characterize student language.</p> <p>Example of an independent situation: Students send a letter, an email message, or a recorded message to a Spanish-speaking pen pal explaining what they do regularly.</p>



SUGGESTIONS FOR ASSESSMENT

**SUGGESTED LEARNING
RESOURCES**

--	--



PRESCRIBED OUTCOMES	SUGGESTIONS FOR INSTRUCTION
<p>2.2 interpret and produce oral texts</p> <p><i>2.2.1 Aural Interpretation</i></p> <ul style="list-style-type: none">❖ understand the main point and some supporting details of lengthy texts on familiar topics in guided situations <p><i>2.2.2 Oral Production</i></p> <ul style="list-style-type: none">❖ produce short texts on unfamiliar topics in guided situations	<ul style="list-style-type: none">➤ Present a video of a movie in Spanish, then ask students, working in small groups, to mindmap the main ideas. Prior to viewing, give students opportunities to become familiar with the important issues, setting, characters, and plot (BC <i>Resource Package</i>, 72).➤ Provide students with the lyrics of a song, with certain target vocabulary/expressions whited out. Have students listen to the song and complete the lyrics as they listen.➤ Ask students to listen to poems in Spanish and then represent them in dramatizations or illustrations (BC <i>Resource Package</i>, 24).➤ Have students prepare a TV or radio newscast, using programs such as CNN <i>en español</i> as a model. Students could include various segments such as sports, news, entertainment, and weather.



SUGGESTIONS FOR ASSESSMENT

- As students mindmap the main ideas of a Spanish movie, look for evidence that
 - main ideas are relevant and clear
 - issues, setting, plot, and characters are identified
 - ideas are shared and elaborated in groups

- When students complete the lyrics of a song that they have listened to, look for evidence that they are able to
 - understand the main points of the song
 - identify key words and expressions

- When students prepare a TV or radio newscast, discuss criteria with students before they begin. Criteria might include the following:
 - relevant information with interesting details
 - appropriate format
 - clear organization of ideas
 - appropriate oral expression (fluency, clarity, pronunciation) (language competence, attend to form)
 - appropriate use of target vocabulary and expressions (language competence, attend to form)
 - collaboration/participation/engagement in preparation of task (strategies)

SUGGESTED LEARNING RESOURCES

¡Dime! Pasaporte al mundo 21

¡En español! 2
Unidad 1, Etapa 3

¡En español! 3
Unidad 6, Etapa 1

Spanish 10G: ¡Bienvenido!
¡Bienvenida!
Video



PRESCRIBED OUTCOMES	SUGGESTIONS FOR INSTRUCTION
<p>2.2 interpret and produce oral texts (continued)</p> <p>2.2.3 <i>Interactive Fluency</i></p> <ul style="list-style-type: none">❖ manage simple, routine interactions without undue difficulty	<ul style="list-style-type: none">➤ As a class, brainstorm possible interview questions. Then have students work with pairs to role-play job interviews. Encourage candidates to answer in terms of interests, qualities, and work and volunteer experiences (BC <i>Resource Package</i>, 52). ➤ Divide the class into groups of three. Ask two students in each group to interview the third as a candidate for the ideal housemate. Before the interviews, have groups prepare lists of possible questions. Encourage students to ask additional questions while conducting the interviews (BC <i>Resource Package</i>, 68).➤ Invite a Spanish-speaking guest from the community who is familiar with/specializes in a particular theme studied. Examples include the following:<ul style="list-style-type: none">• Job/career opportunities in Spanish• Current issues• Exchange students/exchange programs
<p>2.3 interpret and produce written texts</p> <p>2.3.1 <i>Written Interpretation</i></p> <ul style="list-style-type: none">❖ understand the main point and some supporting details of lengthy texts on familiar topics in guided situations	<ul style="list-style-type: none">➤ Facilitate students' reading of a short story in Spanish by providing focus questions, background information, and vocabulary development. Have students create a web to organize the main ideas of the short story (Manitoba Education and Training, <i>Grades 5 to 8 English Language Arts: A Foundation for Implementation</i>, Grade 6 – 132–133).



SUGGESTIONS FOR ASSESSMENT

- Assessment criteria for simulated interviews should focus on the extent to which students
 - present clear, complete, and appropriate messages
 - interact with growing spontaneity
 - sustain interaction with an easy flow of language
 - use vocabulary and idioms effectively (language competence, attend to form)
 - avoid serious errors in tense and structure that obscure communication (language competence, attend to form)

SUGGESTED LEARNING RESOURCES

¡En español! 2
 Unidad 6, Etapa 3
 p. 410

¡En español! 3
 Unidad 1, Etapa 3
 pp. 78, 79, 81, 84, 85

¡Buen Viaje! 2
 Literatura, pp. 430–447

¡Buen Viaje! 3
 Sección de literatura de
 cada capítulo

¡Buen Viaje! 2
 Capítulo 14



PRESCRIBED OUTCOMES	SUGGESTIONS FOR INSTRUCTION
<p>2.3 interpret and produce written texts (continued)</p> <p>2.3.2 <i>Written Production</i></p> <ul style="list-style-type: none">❖ produce short texts on unfamiliar topics in guided situations <p>2.3.3 <i>Visual Interpretation</i></p> <ul style="list-style-type: none">❖ propose several interpretations of the visual elements of a variety of media in guided situations	<ul style="list-style-type: none">➤ Provide students with advertisements for part-time jobs that require knowledge of Spanish. Have each student choose a job and prepare a resume. Ask students to exchange resumes with partners and give reasons why they chose the jobs they did (<i>BC Resource Package, 60</i>).➤ After participating in a gallery walk or virtual tour of artwork by famous Spanish-speaking artists, have students each choose one artist and research the history of the artist and his/her work. Have students use their research to produce an informational text about the artist for a gallery catalogue.➤ Have students participate in a gallery walk of artwork by various famous Spanish-speaking artists. Have students identify the feelings and emotions the art evokes as well as the techniques used to create the mood/emotions of the piece. Alternatively, have students participate in a virtual tour of a museum via the Internet.➤ Have students form groups and identify a current issue that is prevalent in the media. Have each student find a visual representation of the issue (e.g., a picture or editorial cartoon from a newspaper, a newspaper or magazine ad, a TV commercial, etc.). Then have students work in their groups to identify the techniques used in order to send a particular message to the public. Have students present their findings to the class.



SUGGESTIONS FOR ASSESSMENT

SUGGESTED LEARNING RESOURCES

- Work with students to develop criteria for their resumes:
 - accurate and relevant information is included
 - format is appropriate
 - target vocabulary and expressions are used correctly (language competence, attend to form)
 - layout is clear and organized

- When students research the history of an artist and his/her work, discuss criteria with students before they begin. Criteria might include the following:
 - appropriate format
 - detailed and accurate information is provided
 - language structures, vocabulary, and verb tenses are used correctly (language competence, attend to form)

- As students react to artwork by famous Spanish-speaking artists, look for evidence that they are able to
 - describe techniques and conventions used by artist
 - explain/interpret artist’s work
 - identify feelings and emotions evoked by artwork
 - use target language pertaining to art and expressing opinions

- As students analyze visual interpretations of current issues in the media, look for evidence that they are able to
 - identify techniques and explain their effectiveness
 - work collaboratively with group members (strategies)
 - present techniques to class clearly, with appropriate pronunciation, fluency, and intonation (language competence, attend to form)

¡En español!
Unidad 6, Etapa 1, 2, 3

¡Buen Viaje! 2
Capítulo 14

Internet

Destinos: An Introduction to Spanish
Video Series

¡Dime! Pasaporte al mundo 21

¡Dime! Pasaporte al mundo 21

Destinos: An Introduction to Spanish
Video Series
Museo El Prado

Internet

¡En español! 2
Unidad 1, Etapa 3,
p. 72

¡En español! 3
Unidad 6, Etapa 1
p. 390

¡Buen Viaje! 3
Capítulo 5
pp. 223–229



PRESCRIBED OUTCOMES	SUGGESTIONS FOR INSTRUCTION
<p>2.3 interpret and produce written texts (continued)</p> <p>2.3.4 <i>Representation</i></p> <ul style="list-style-type: none">❖ explore a variety of ways that meaning can be expressed through the visual elements of a variety of media in guided situations	<ul style="list-style-type: none">➤ Invite students to research a current issue that interests them (e.g., the environment, child poverty) using brochures, articles, videos, or films as resources. Then ask them to organize awareness campaigns for the class. Campaigns could be carried out using posters, public announcements, leaflets, and fundraising activities (BC <i>Resource Package</i>, 62). ➤ After students have become familiar with the main aspects of a short story in Spanish, have students form groups and have each group select a part of the story to re-create in a chosen visual medium. Ask students to present and display their work for peer responses (BC <i>Resource Package</i>, 72). ➤ Invite students to view examples of stelae (carved Mayan stone pillars commemorating important people and events in Mayan history). Then have them create their own stelae, each representing at least four important events in the student's life (e.g., a special birthday). Have each student share his or her stela with a partner and explain what it represents or symbolizes. As an extension, suggest that students compare Mayan stelae with First Nations totem poles (e.g., similarities, differences, material used, decorative style, and symbolism) (BC <i>Resource Package</i>, 32).



SUGGESTIONS FOR ASSESSMENT	SUGGESTED LEARNING RESOURCES
<p>➤ Work with students to develop criteria for their awareness campaigns on current issues. Criteria could include the following:</p> <ul style="list-style-type: none"> • information is accurate and relevant • includes appropriate details designed to appeal or convince the audience • a variety of visual techniques are used • visual techniques are effective in conveying the message • presentation is clear and easy to follow • vocabulary, expressions, and structure are appropriate and add to the effect 	<p><i>¡En español! 2</i> Unidad 5, Etapa 1, 2, 3</p> <p><i>¡En español! 3</i> Unidad 5, Etapa 3</p> <p><i>¡Dime! Pasaporte al mundo 21</i></p> <p><i>¡Buen Viaje! 2</i> Capítulo 8, p. 237 Capítulo 11, p. 322, 323</p> <p><i>¡Buen Viaje! 3</i> Capítulo 7 pp. 322–326</p>
<p>➤ When students re-create short stories, look for evidence that they are able to</p> <ul style="list-style-type: none"> • identify and explain techniques and conventions used to express meaning • interpret the feeling, ideas, and themes of the original work • incorporate detail to engage the audience 	<p><i>¡Dime! Pasaporte al mundo 21</i></p> <p><i>¡Buen Viaje! 2</i> Literatura</p> <p><i>¡Buen Viaje! 3</i> Literatura</p>
<p>➤ Before students make their own stelae, work with them to develop criteria such as the following:</p> <ul style="list-style-type: none"> • techniques and conventions used in the creation of stelae are identified • required information is included (four events with dates) • symbols presents (glyphs) for important events • dates written in Mayan number system • attention to detail of the Mayan samples 	<p><i>¡En español! 3</i> Unidad 5, Etapa 2 pp. 360, 361</p> <p><i>¡Dime! Pasaporte al mundo 21</i> Unidad 3, Lección 1 pp. 134, 135</p> <p><i>¡Buen Viaje! 3</i> Capítulo 8 pp. 371–377</p>



PRESCRIBED OUTCOMES	SUGGESTIONS FOR INSTRUCTION
<p>2.4 apply knowledge of the sociocultural context</p> <p>2.4.1 <i>Register</i></p> <ul style="list-style-type: none">❖ explore differences in register between spoken and written texts <p>2.4.2 <i>Idiomatic Expressions</i></p> <ul style="list-style-type: none">❖ identify influences on idiomatic expressions (e.g., region, age, occupation) <p>2.4.3 <i>Variations in Language</i></p> <ul style="list-style-type: none">❖ experiment with and adapt to some variations in language	<ul style="list-style-type: none">➤ As students prepare job interviews, participate in debates, and engage in conversations with peers about studying abroad, provide them with expressions appropriate for each of these situations. ➤ Provide students with idiomatic expressions that are specific to different Spanish-speaking countries. Choose expressions that have the same meaning, but, of course, the expression is different for each country. Have students work in groups and provide each group with a different expression from a different country, but all with the same meaning. Have students prepare a short dialogue using the expression they have been given. After students have presented their dialogues, review the variety of expressions that exist in different countries to represent the same meaning. ➤ Provide students with a text geared for adults (e.g., an article) and provide them with a second text geared for children (e.g., fable, legend, modern children’s literature). Then have students work in pairs or small groups to identify how language is used differently in each text (e.g., length of sentences, vocabulary, illustrations, etc.). Have students create their own text in both child and adult forms, taking into consideration difference/variations in language.



SUGGESTIONS FOR ASSESSMENT	SUGGESTED LEARNING RESOURCES
<p>➤ When students prepare activities with varying degrees of formality, look for evidence that they</p> <ul style="list-style-type: none"> • use formal (<i>usted</i>) and informal (<i>tú</i>) appropriately • use vocabulary and expressions appropriate to formal and informal situations 	<p><i>¡En español! 2</i> Unidad 6, Etapa 2 p. 410</p> <p><i>¡En español! 3</i> Unidad 2, Etapa 1 pp. 106, 107</p> <p><i>¡Buen Viaje! 2</i> Capítulo 14</p>
<p>➤ As students interpret idiomatic expressions through dialogues, look for evidence that</p> <ul style="list-style-type: none"> • idiomatic expression is appropriately interpreted (dialogue and idiomatic expression correspond) • appropriate oral expression (pronunciation, intonation, fluency) is used (language competence, attend to form) 	<p><i>101 Spanish Idioms</i></p> <p><i>¡En español! 2, 3</i> Refrán</p>
<p>➤ As students examine texts for adults and children, look for evidence that they are able to</p> <ul style="list-style-type: none"> • identify key differences in sentence structure, vocabulary, and illustrations • create texts geared towards children and adults with variations evident 	<p><i>¡En español! 3</i> Unidad 3, Etapa 3 pp. 234, 235</p>



PRESCRIBED OUTCOMES	SUGGESTIONS FOR INSTRUCTION
<p>2.4 apply knowledge of the sociocultural context (continued)</p> <p>2.4.4 <i>Social Conventions</i></p> <ul style="list-style-type: none">❖ use politeness conventions in a variety of contexts <p>2.4.5 <i>Non-verbal Communication</i></p> <ul style="list-style-type: none">❖ interpret and use a variety of non-verbal behaviours in a variety of contexts	<ul style="list-style-type: none">➤ Give students social situations and ask them to improvise the situation, using appropriate formal and informal social conventions. Have some groups present in a very formal manner and others in a less formal manner.➤ Have students work in groups of three or four. Students prepare a short skit in which one person narrates the scene and the other members of the group use only actions and gestures to tell the story.
<p>2.5 apply knowledge of how text is organized, structured, and sequenced</p> <p>2.5.1 <i>Cohesion/Coherence</i></p> <ul style="list-style-type: none">❖ use appropriate words or phrases to show relationships in texts (e.g., <i>por tanto, por lo tanto, además, pero, de una manera</i>)	<ul style="list-style-type: none">➤ Provide students with a newspaper or magazine article on a current issue. Have students first read the text individually and highlight transition words, connectors, and words that help establish a sequence. <p>Students then work with a partner to review the words each person found. Discuss the findings as a whole class and put the key words on posters.</p>



SUGGESTIONS FOR ASSESSMENT

SUGGESTED LEARNING RESOURCES

- When students improvise social situations, assessment criteria might include the following:
 - social conventions are applied appropriately
 - language is understandable and appropriate to the context

- When students prepare a skit in which one person narrates and the others use actions and gestures, look for evidence that
 - gestures correspond with narrator’s story
 - actions are clear
 - narrator’s language use is appropriate (verb tenses, vocabulary, and expressions) (language competence, attend to form)
 - participation and interaction within group is evident (strategies)

- As students examine texts for transition words, connectors, and words that help create sequence, look for evidence that they are able to
 - identify key words that establish sequence and transition
 - organize key words logically for poster

Diccionario de gestos

¡Buen Viaje! 2
 Capítulo 5, pp. 213–215
 Capítulo 8, p. 365



PRESCRIBED OUTCOMES	SUGGESTIONS FOR INSTRUCTION
<p data-bbox="103 281 558 386">2.5 apply knowledge of how text is organized, structured, and sequenced (continued)</p> <p data-bbox="103 407 318 436">2.5.2 <i>Text Forms</i></p> <ul data-bbox="175 466 539 667" style="list-style-type: none">❖ use a variety of familiar text forms and media in their own productions (e.g., poetry, stories, media articles, websites, reports) <p data-bbox="103 877 526 907">2.5.3 <i>Patterns of Social Interaction</i></p> <ul data-bbox="175 936 552 1138" style="list-style-type: none">❖ combine simple social interaction patterns to perform complex transactions and interactions (e.g., request goods/services)	<p data-bbox="604 466 1419 634">➤ Have students prepare a comparison chart of different types of poetry or short stories (e.g., choose same author—two different pieces, or one theme—two different authors). Have students write a poem similar to the poems analyzed.</p> <p data-bbox="604 928 1419 1033">➤ Provide students with the opportunities to use a wide range of social interaction patterns within the themes studied. Examples include the following:</p> <ol data-bbox="652 1045 1419 1642" style="list-style-type: none">1. Planning to study abroad<ul data-bbox="695 1087 1419 1234" style="list-style-type: none">• Have students write letters or send emails to various institutions where they might study.• Have students invite an exchange student to speak to the class (via phone or letter).2. Current Issues<ul data-bbox="695 1297 1419 1444" style="list-style-type: none">• Have students write a Letter to the Editor regarding an issue.• Have students write letters to officials of other nations.3. Looking for an apartment<ul data-bbox="695 1507 1419 1642" style="list-style-type: none">• Have students read an ad and role-play phoning to ask for additional information.• Have students negotiate conditions for apartment (cost, utilities, damage deposit, etc.).



SUGGESTIONS FOR ASSESSMENT

- As students compare different types of poetry or short stories, look for evidence that they are able to
 - express their opinions and conclusions
 - provide examples
 - identify key features of the text form
 - use target vocabulary and expressions for comparison
 - organize chart clearly and accurately
 - produce a poem which follows format studied

- When students use social interaction patterns in the context of themes studied, consider the following criteria:
 - language use is appropriate to the situation (formality, vocabulary, and expressions)
 - appropriate format is used for the situation
 - accurate and relevant information is provided

Look for evidence that students are able to

 - use previously learned patterns in new situations
 - combine previously learned patterns to extend interactions
 - handle non-routine situations

SUGGESTED LEARNING RESOURCES

Ventanas tres

Internet

¡Buen Viaje! 2
Literatura

¡Buen Viaje! 3
Literatura

¡En español! 2
Unidad 6, Etapa 1, p. 388
Unidad 6, Etapa 2, p. 426

¡Buen Viaje! 2
Capítulo 8, p. 237
Capítulo 11 pp. 322, 323

¡Buen Viaje! 3
Capítulo 5, pp. 213–215
Capítulo 6, pp. 262–264
Capítulo 8, p. 365



Notes

*GLOBAL
CITIZENSHIP
YEAR 6*



Global Citizenship



study historical and contemporary elements of Spanish-speaking cultures

affirm diversity

Students will acquire the knowledge, skills, and attitudes to be effective global citizens, through the exploration of the cultures of the Spanish-speaking world.

explore personal and career opportunities



GLOBAL CITIZENSHIP

General Outcome 3: Students will acquire the knowledge, skills, and attitudes to be effective global citizens, through the exploration of the cultures of the Spanish-speaking world.

The outcomes for Global Citizenship deal with a broad range of knowledge, skills, and attitudes needed to be effective global citizens—in other words, with the development of intercultural competence. The concept of global citizenship encompasses citizenship at all levels, from the local school and community to Canada and the world.

The various components of global citizenship are grouped under three cluster headings—see the illustration on the preceding page. Under each of these headings there are several strands. Each strand deals with a single aspect of intercultural competence. For example, under the cluster heading **study historical and contemporary elements of Spanish-speaking cultures**, there are strands for the processes and methods of acquiring knowledge about Spanish-speaking cultures, the cultural knowledge thus acquired, applications of that knowledge to aid comprehension and to communicate in appropriate ways, positive attitudes toward Spanish-speaking cultures, as well as knowledge of the diversity within those cultures.

Developing cultural knowledge and skills is a lifelong process. Knowledge of one's own culture is acquired over a lifetime. Cultures change over time. Within any national group, there may be a dominant culture or cultures and a number of minority cultures. Rather than try to develop an extensive bank of knowledge about the Spanish-speaking cultures, it is more important for students to learn the processes and methods of accessing and analyzing cultural practices. Students will gain cultural knowledge in the process of developing these skills. In this way, if they encounter elements of the Spanish-speaking cultures they have not learned about in class, they will have the skills and abilities to deal with them effectively and appropriately.

The **affirm diversity** heading covers knowledge, skills, and attitudes that are developed as a result of bringing other languages and cultures into relationship with one's own. There is a natural tendency, when learning a new language and culture, to compare it with what is familiar. Many students leave a second language learning experience with a heightened awareness and knowledge of their own language and culture. They will also be able to make some generalizations about languages and cultures based on their experiences and those of their classmates who may have a variety of cultural backgrounds. This will provide students with an understanding of diversity within both a global and a Canadian context.



PRESCRIBED OUTCOMES	SUGGESTIONS FOR INSTRUCTION
<p>General Outcome 3: Global Citizenship</p> <p>Students will acquire the knowledge, skills, and attitudes to be effective global citizens through the exploration of the cultures of the Spanish-speaking world.</p> <p>3.1 study historical and contemporary elements of Spanish-speaking cultures</p> <p>3.1.1 <i>Access/Analyze Cultural Knowledge</i></p> <ul style="list-style-type: none">❖ organize and represent information about elements of Spanish-speaking cultures in a variety of ways <p>3.1.2 <i>Knowledge of Spanish-Speaking Cultures</i></p> <ul style="list-style-type: none">❖ explore and identify some elements of Spanish-speaking cultures (e.g., major current events as a reflection of contemporary ways of life and cultural values)	<p>➤ As a class, brainstorm the impact of the Spanish arrival on indigenous peoples in various regions of Central and South America. Have students each select a region and research its development from the Conquest to the present day. Students could focus on topics such as resistance to the Spanish, the colonial era, independence movements, and current political situations. Ask the students to present their findings orally and in writing (BC <i>Resource Package</i>, 74).</p> <p>➤ Have students investigate past and present gender roles in the Spanish-speaking world. Information could be collected from sources such as videos, stories, songs, and guest speakers. Have students identify traditional values in areas relating to dating customs, the work force, marriage, and relationships. As a class, discuss the extent to which these values have changed (BC <i>Resource Package</i>, 66).</p>



SUGGESTIONS FOR ASSESSMENT

SUGGESTED LEARNING RESOURCES

- When students prepare research on an indigenous people and the impact of the Spanish arrival, provide students with criteria before they begin. Criteria might include the following:
 - the impact of the Spanish arrival on indigenous people is clearly identified
 - shows insight into the context and the impact on indigenous peoples
 - information is accurate (applications)
 - interesting details are provided (applications)

- When students investigate gender roles, look for evidence that they are able to
 - seek out valid and credible information and evaluate it
 - go beyond surface features to deal with subtle and complex aspects
 - pose thoughtful questions about culture and lifestyle
 - use personal experiences

¡En español! 2
Unidad 2, Etapa 3
pp. 160, 161

¡En español! 3
Etapa preliminar
pp. 18, 19
Unidad 4, Etapa 3
pp.308, 309
Unidad 5, Etapa 2

¡Dime! Pasaporte al mundo 21
Unidad 3, Lección 1
p. 12
Unidad 3, Lección 3
pp. 154–157

¡Buen Viaje! 3
Capítulo 8

¡Buen viaje! 3
Capítulo 4, 6

¡Buen Viaje! 3
Video



SUGGESTIONS FOR ASSESSMENT

SUGGESTED LEARNING RESOURCES

- When students prepare a biography of a contemporary author, artist, or painter, provide students with assessment criteria before they begin. Criteria might include the following:
 - importance/influence/role of person in and on Spanish-speaking cultures and global society is clearly identified
 - information is accurate (applications)
 - interesting details are included (applications)
 - well organized paragraphs (language competence, written production)
 - appropriate use of verb tenses, vocabulary , and other language structures (language competence, attend to form)
 - correct spelling and punctuation (language competence, attend to form)

- When students present one aspect of contemporary culture, provide them with criteria before they begin. Criteria might include the following:

- detailed knowledge of cultural characteristics
- awareness and use of a variety of current resources

Language Competence Outcomes:

- appropriate use of verb tenses, vocabulary, and other language structures
- correct spelling and punctuation
- pronunciation and intonation are accurate

Internet

¡Dime! Pasaporte al mundo 21

¡En español! 2

Sección: En Voces

¡Buen Viaje! 2, 3

Literatura

¡En español! 2

Unidad 6, Etapa 3
pp. 450, 451

¡En español! 3

Unidad 1, Etapa 3
pp. 92, 93

Unidad 3, Etapa 2
pp. 212, 213

Unidad 5, Etapa 1
pp. 320, 321

¡Dime! Pasaporte al mundo 21



PRESCRIBED OUTCOMES	SUGGESTIONS FOR INSTRUCTION
<p>3.1 study historical and contemporary elements of Spanish-speaking cultures (continued)</p> <p>3.1.5 <i>Value Spanish-Speaking Cultures</i></p> <ul style="list-style-type: none">❖ seek out and use opportunities to enter into contact with members of Spanish-speaking cultures (e.g., exchange letters with a pen pal)	<ul style="list-style-type: none">➤ Have students work in pairs to research one Spanish-speaking country. Have students prepare a kiosk in the class or in the gymnasium that provides information about the country as well as a sample of a food dish popular in the country. Have students invite a person of Spanish-speaking background to participate in your display. After the presentations/kiosks, have students discuss the value of Spanish-speaking cultures for themselves and for the global society.
<p>3.2 affirm diversity</p> <p>3.2.1 <i>Awareness of First Language</i></p> <ul style="list-style-type: none">❖ analyze the ways in which their first language and Spanish are similar and ways that they are different	<ul style="list-style-type: none">➤ Ask students to look through Spanish magazines and cut clippings/pictures/ads that use Spanish. Then have students do the same with magazines in English. Have students prepare a collage/poster that shows similarities and differences in vocabulary and sentence structure.



SUGGESTIONS FOR ASSESSMENT

SUGGESTED LEARNING RESOURCES

- When students prepare a kiosk about a Spanish-speaking country, provide students with assessment criteria before they begin. Criteria might include the following:
 - students are able to suggest why Spanish-speaking cultures are valuable for themselves and the global society
 - information is clear and pertinent (applications)
 - collaboration and interaction during preparation of kiosk is evident (strategies)

- When students create a collage or poster showing similarities and differences in vocabulary and sentence structure, look for evidence that students are able to
 - clearly identify similarities and differences
 - provide examples of similarities and differences
 - create an organized poster, with appropriate layout

(See criteria for poster assessment in Planning, p. 86.)

¡Dime! Pasaporte al mundo 21

Internet

¡Buen Viaje! 2, 3



PRESCRIBED OUTCOMES	SUGGESTIONS FOR INSTRUCTION
<p data-bbox="103 281 552 317">3.2 affirm diversity (continued)</p> <p data-bbox="103 333 521 369">3.2.4 <i>General Cultural Knowledge</i></p> <ul data-bbox="175 390 545 636" style="list-style-type: none">❖ describe some causes of breakdown in communication and of misunderstanding when communicating with people from an unfamiliar culture <p data-bbox="103 743 370 779">3.2.5 <i>Value Diversity</i></p> <ul data-bbox="175 800 552 1079" style="list-style-type: none">❖ seek out opportunities to interact with people from various cultures that have an interest in the Spanish language and/or Spanish-speaking cultures being studied <p data-bbox="103 1272 407 1308">3.2.6 <i>Intercultural Skills</i></p> <ul data-bbox="175 1329 537 1717" style="list-style-type: none">❖ use a variety of strategies for dealing with breakdowns in communication and misunderstandings when encountering an unfamiliar culture❖ identify ethnocentric perspectives in a document or event, and explain their origins	<p data-bbox="605 390 1414 674">➤ Brainstorm with students the main aspects that are important in functioning in a Spanish-speaking country (daily life situations). Have students then work in pairs, choose a Spanish-speaking country, and make contacts with people from the community, visit embassies, and use guide books and the Internet in order to find information about these daily life situations in each country (e.g., bank procedures, shopping customs, etc.).</p> <p data-bbox="605 800 1377 869">➤ Invite recent landed immigrants to class and have them share their experiences with students.</p> <p data-bbox="605 1329 1422 1465">➤ Have students participate in a sharing circle with the invited guests in which each person has the opportunity to give his/her opinion of the theme chosen as well as ask for clarification.</p>



SUGGESTIONS FOR ASSESSMENT

SUGGESTED LEARNING RESOURCES

- Look for evidence that students are able to identify the important factors involved in intercultural competence, in daily life situations.

- When students participate in discussions with recent landed immigrants, look for evidence that students
 - have gained an appreciation for linguistic and cultural diversity for themselves and global society
 - pose questions that are well prepared and pertinent
 - listen to others; interact
 - add to and build on ideas of others
 - participate in Spanish

(See a guest observation assessment tool in Planning, p. 73.)

- Look for evidence that students are able to communicate effectively with guests.



PRESCRIBED OUTCOMES	SUGGESTIONS FOR INSTRUCTION
<p>3.3 personal and career opportunities</p> <p>3.3.1 <i>Spanish Language and Spanish-Speaking Cultures</i></p> <ul style="list-style-type: none">❖ explore opportunities for further education related to Spanish and Spanish-speaking cultures <p>3.3.2 <i>Cultural and Linguistic Diversity</i></p> <ul style="list-style-type: none">❖ explore opportunities for further education related to languages and cultures	<p>➤ Have students examine classified ads from Spanish-speaking countries and have them identify jobs that are in high demand.</p> <p>➤ Have students research job opportunities through the Spanish or Mexican embassy.</p> <p>➤ Suggest that students review programs of study from various postsecondary institutions in Spanish-speaking countries. On the basis of the information provided, each student decides which institution he/she would like to attend, fills out the application forms, prepares a resume, and composes a cover letter stating reasons for wanting to enroll at that institution (BC <i>Resource Package</i>, 70).</p> <p>➤ Invite guests who work with the language to talk about job opportunities in their field, how they use the language, what their job entails, and what the prerequisites for the job are (e.g., a translator, a flight attendant, etc.).</p>



SUGGESTIONS FOR ASSESSMENT

- Look for evidence that students research a variety of sources to inform themselves on how knowledge of Spanish and Spanish-speaking cultures is applicable and useful in the global workplace/marketplace.

- Assess students' application forms, resumes, and covering letters for the following:
 - completeness—all appropriate detail is included
 - clarity—information is clear and easy to follow
 - persuasiveness—relevant details and examples effectively support the applications
 - presentation—language and structures are accurate and show a relatively high degree of sophistication and complexity (language competence, attend to form)

SUGGESTED LEARNING RESOURCES

¡Dime! Dos
 Unidad 7, Lección 2,



Notes

STRATEGIES
YEAR 6





Strategies

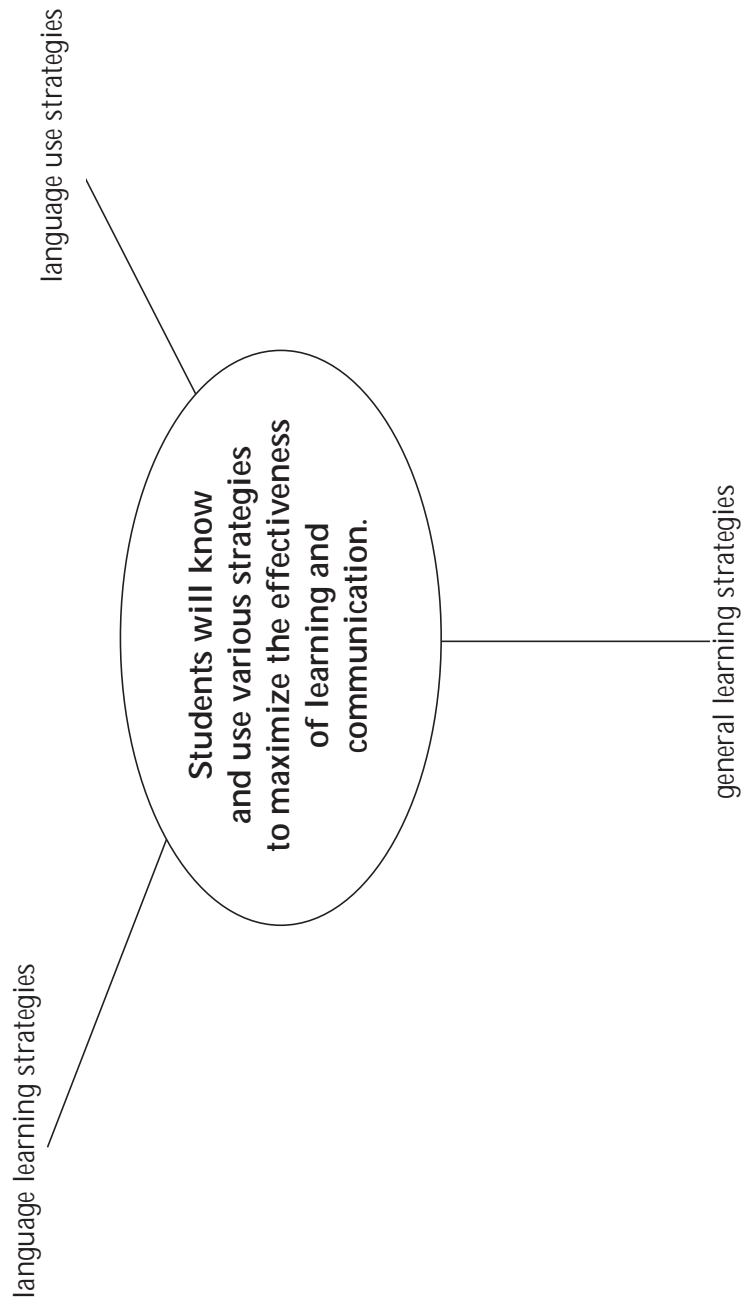



PRESCRIBED OUTCOMES	SUGGESTIONS FOR INSTRUCTION
<p>General Outcome 4: Strategies Students will know and use various strategies to maximize the effectiveness of learning and communication.</p> <p>4.1 language learning strategies</p> <p>4.1.1 <i>Cognitive</i></p> <ul style="list-style-type: none">❖ evaluate the success of their use of a variety of cognitive strategies to enhance language learning <p>4.1.2 <i>Metacognitive</i></p> <ul style="list-style-type: none">❖ evaluate the success of their use of a variety of metacognitive strategies to enhance language learning	<p>➤ Read aloud a section of a text (short story, poem, etc.). Allow students two to three minutes to sketch following the reading. Have students share their sketches with a partner, discussing the main ideas and their representation. Have students write the big ideas revealed in the section of the text beside the sketch. Continue the reading of the selection, repeating the sketch-share process. Have students use the sketches and big ideas to complete a summary of the material heard (Manitoba Education and Training, <i>Grades 5 to 8 English Language Arts: A Foundation for Implementation</i>, Strategies – 206). In a learning log, have students discuss how the strategies used helped them better understand the text.</p> <p>➤ Have students prepare a vocabulary dictionary during each theme studied—<i>Tema, Verbos, Nombres, Adjetivos, Expresiones</i>.</p> <p>A part of the dictionary could also be devoted to idiomatic expressions from various Spanish-speaking countries and important transitional and sequential words.</p> <p>➤ As students work with a variety of texts, encourage them to reflect on and assess their strategies for acquiring meaning. Questions might include the following:</p> <ul style="list-style-type: none">• What are some of the helpful things you learned about Spanish words and patterns?• How can you use this knowledge to help you with new materials?• What strategies did you use to help you understand the text?



SUGGESTIONS FOR ASSESSMENT

SUGGESTED LEARNING RESOURCES

- As students sketch, pair, and share, look for evidence that they are able to
 - identify main ideas
 - create sketches that correlate with main ideas

- Review students' vocabulary dictionaries for evidence that students are able to
 - record appropriate meanings for the words and phrases they include
 - organize words and phrases in a logical way
 - extend their dictionaries as they encounter new words and expressions

- Assess students' reflection journals for evidence that they are able to
 - articulate the strategies that they used
 - give reasons/explanations of why certain strategies were more useful to them

¡En español! 2
 Unidad 5, Etapa 3
 pp. 376, 377
 Unidad 6, Etapa 1
 pp.404, 405

¡En español! 2
 Unidad 2, Etapa 3
 pp.162, 163
¡Buen Viaje! 2, 3
 Literatura

¡Buen Viaje! 3
 Capítulo 5, pp. 213–215
 Capítulo 8, p. 365



PRESCRIBED OUTCOMES	SUGGESTIONS FOR INSTRUCTION
<p>4.1 language learning strategies (continued)</p> <p>4.1.3 <i>Social/Affective</i></p> <ul style="list-style-type: none">❖ evaluate the success of their use of a variety of social and affective strategies to enhance language learning	<ul style="list-style-type: none">➤ When students participate in a student exchange, an interview, or other communicative tasks with Spanish-speaking individuals, ask them to do a reflective journal piece on their use of social and affective strategies. Encourage them to contemplate how they could use a greater variety or use specific strategies more effectively.
<p>4.2 language use strategies</p> <p>4.2.1 <i>Interactive</i></p> <ul style="list-style-type: none">❖ evaluate the success of their use of a variety of interactive strategies to deal with specific communicative situations (e.g., use a range of fillers, hesitation devices, and gambits to sustain conversations; use circumlocution to compensate for lack of vocabulary)	<ul style="list-style-type: none">➤ Have students participate in an inside/outside circle activity and provide students with paraphrasing expressions/vocabulary in order to better maintain the flow of the conversation. <p>Inside/outside circle activity: Arrange students in two circles where they are facing each other. Ask students in the outside circle to rotate in one direction and the students in the inside circle to rotate in the opposite direction. At a given time, ask students to stop moving. Each student will converse with the person he/she is facing.</p> <p>Have students then evaluate how successfully they were able to use interactive strategies in order to maintain communication.</p>



SUGGESTIONS FOR ASSESSMENT

SUGGESTED LEARNING RESOURCES

- Have students hand in their journals. Look for evidence of the following:
 - identification of specific strategies used
 - discussion of the effectiveness of the strategies used
 - consideration of additional strategies or a more effective use of the strategies already used

- As students participate in an inside/outside circle activity, look for evidence that they are
 - interacting with partners
 - attempting paraphrasing techniques to ensure understanding and maintain flow of the conversation

Success for All Learners
¡Buen Viaje! 3
 p. 365



PRESCRIBED OUTCOMES	SUGGESTIONS FOR INSTRUCTION
<p>4.2 language use strategies (continued)</p> <p>4.2.2 <i>Interpretive</i></p> <ul style="list-style-type: none">❖ evaluate the success of their use of a variety of interpretative strategies to deal with specific communicative situations (e.g., use key content words or discourse markers to follow extended text) <p>4.2.3 <i>Productive</i></p> <ul style="list-style-type: none">❖ evaluate the success of their use of a variety of productive strategies to deal with specific communicative situations (e.g., take notes when reading or listening to assist in producing personal texts)	<p>➤ Provide students with an article about a current issue. First have them read the article individually. Then ask students to work in pairs and to re-read the article out loud. In pairs, have students then complete an analysis of an issue-based article (Manitoba Education and Training, <i>Success for All Learners</i>, 6.117, Annex 22). In a learning log, have students then evaluate whether or not the use of the analysis of an issue-based article was effective/useful in helping them understand the article.</p> <p>(See form for analysis of an issue-based article in Planning, p. 84.)</p> <p>➤ Have students individually read the lyrics to a song or a poem. Then have students work in small groups to determine the meaning and message, using key words to help them determine meaning.</p> <p>➤ Provide students with examples of Spanish legends and myths. Read together or in groups, with students taking turns to read out loud. Have students take notes or visually represent what they hear and then discuss and reflect on the story, characters, and author's intent or theme. Have groups choose a legend/myth and review it into a script. In a learning log, have students reflect on the effectiveness of taking notes or visually representing the story in order to better understand it.</p>



SUGGESTIONS FOR ASSESSMENT

- When students complete an analysis of an issue-based article or determine the meaning and message of a song, look for evidence that students
 - attempt to infer meaning through re-reading
 - use a variety of interpretive strategies to understand the text
 - select strategies that are appropriate to the type of text and reading task

(See a current issue reflection log in Planning, p. 89.)

- As students work in pairs to take notes based on an article, look for evidence that they are able to
 - focus on key words and phrases
 - listen attentively/actively to partner
 - make accurate modifications to notes during verification
 - use their notes to reproduce article accurately in written form

SUGGESTED LEARNING RESOURCES

Success for All Learners
p. 6.117, Annex 22

Ventanas tres

¡Dime! Pasaporte al mundo 21

¡Buen Viaje! 2

Capítulo 8, p. 237

Capítulo 11, pp. 322, 323

¡Buen Viaje! 3

Capítulo 7, pp. 322–326

¡Buen Viaje! 3

Capítulo 1, pp. 44–51

Capítulo 2, pp. 92–95

Capítulo 3, pp. 140–144

Capítulo 5, pp. 239–243

Capítulo 8 pp. 395–397; 404–407

¡En español! 3

Unidad 3, Etapa 1,
pp 190, 191

Unidad 3, Etapa 3
pp. 234, 235

¡En español! 2

Unidad 1, Etapa 3

¡Dime! Pasaporte al mundo 21

Sección: Ventanas al
mundo 21

¡Buen Viaje! 3

Sección periodismo

Planet@ 3 and 4

Sección: Ruta literaria



PRESCRIBED OUTCOMES	SUGGESTIONS FOR INSTRUCTION
<p>4.3 general learning strategies</p> <p>4.3.1 <i>Cognitive</i></p> <ul style="list-style-type: none">❖ select and use appropriate cognitive strategies to enhance general learning in a variety of situations (e.g., make inferences, identify and justify the evidence on which their inferences are based) <p>4.3.2 <i>Metacognitive</i></p> <ul style="list-style-type: none">❖ select and use appropriate metacognitive strategies to enhance general learning in a variety of situations (e.g., work with others to monitor their own learning) <p>4.3.3 <i>Social/Affective</i></p> <ul style="list-style-type: none">❖ select and use appropriate social and affective strategies to enhance general learning in a variety of situations (e.g., take risks, try unfamiliar tasks and approaches)	<p>➤ Have students view a video on a target theme and have them prepare a mind map of the purpose/intent of the video as well as evidence on which they base their opinion. Students then work with a partner to examine the combined ideas of both people, and finally, students share their information with the class.</p> <p>➤ Have students list current issues. Then in pairs have them focus on one current event. For two weeks, students must gather information about their particular issue. In the third week, have students give a summary of the two weeks' news in the form of a news broadcast. During this assignment, have students keep a reflection journal in which they examine their learning process, how working with a partner helped them, and what they found challenging.</p> <p>(See questions for reflection log in Planning, p. 89.)</p> <p>➤ Author's Chair—After studying a literary piece or genre, ask students to write a poem or short story based on the literary piece studied. Have students present to the class and have classmates ask students questions on the students' writing. As an extension, put all pieces together and create a class anthology, with each student receiving a copy.</p> <p>➤ Ask students to brainstorm situations outside of school in which they can use Spanish, either in person, by telephone, in writing, or via the Internet. Have students work in pairs to apply their Spanish skills in out-of-school situations.</p>



SUGGESTIONS FOR ASSESSMENT	SUGGESTED LEARNING RESOURCES
<p>➤ As students prepare mindmaps of the purpose/intent of a video, look for evidence that</p> <ul style="list-style-type: none"> • ideas are relevant • examples/evidence for opinions is given • interaction and collaboration with partner is evident 	<p><i>¡Buen Viaje! 3</i> Video</p>
<p>➤ When students complete a reflection journal of their experiences during partner work, look for evidence that students are able to</p> <ul style="list-style-type: none"> • express/explain aspects of their learning • explain the effectiveness and challenges of working in pairs • suggest areas of improvement for future tasks 	<p><i>¡En español! 3</i> Unidad 2, Etapa 1, 2, 3</p> <p><i>¡Buen Viaje! 2</i> Capítulo 8, p. 237 Capítulo 11 pp. 322, 323</p> <p><i>¡Buen Viaje! 3</i> Capítulo 7 pp. 322–326</p>
<p>➤ As students participate in an Author’s Chair activity, look for evidence that students are able to</p> <ul style="list-style-type: none"> • take risks to ask and respond to questions thoughtfully • interact and participate in the discussion 	<p><i>Ventanas tres</i></p> <p><i>¡Dime! Pasaporte al mundo 21</i> Sección: Gente del mundo</p> <p><i>¡Buen Viaje! 2, 3</i> Literatura</p>



Notes

TEACHING AND LEARNING SPANISH LANGUAGE AND CULTURE

The Philosophy and Principles of Teaching and
Learning Spanish Language and Culture 3

Teaching and Learning in the Spanish Classroom 45

Combined Grades in the Second Language Classroom 105

TEACHING AND LEARNING SPANISH LANGUAGE AND CULTURE

The Philosophy and Principles of Teaching and Learning Spanish Language and Culture

Second Language Teaching Methodologies*

Theodore Rodgers argues that methodology in second language teaching has been characterized in a variety of ways. A somewhat classical formulation suggests that methodology is that which links theory and practice. Theory statements would include theories of what language is and how language is learned or, more specifically, theories of second language acquisition (SLA). Such theories are linked to various design features of language instruction. These design features might include stated objectives, syllabus specifications, types of activities, roles of teachers and learners, materials, and so forth. Design features in turn are linked to actual teaching and learning practices as observed in the environments where language teaching and learning take place. This whole complex of elements defines language teaching methodology.

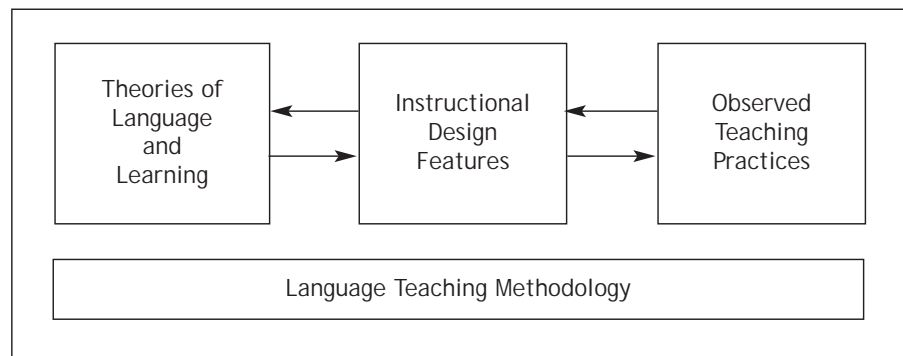

Figure 1. Language Teaching Methodology

(From: *Language Teaching Methodology* by Theodore S. Rodgers, Professor Emeritus, University of Hawaii)

Schools of Language Teaching Methodology

Within methodology a distinction is often made between methods and approaches. Methods are held to be fixed teaching systems with prescribed techniques and practices, whereas approaches represent language teaching philosophies that can be interpreted and applied

* Adapted from *Language Teaching Methodology* by Theodore S. Rodgers, Professor Emeritus, University of Hawaii.

in a variety of different ways in the classroom. This distinction is probably most usefully seen as defining a continuum of entities ranging from highly prescribed methods to loosely described approaches.

The period from the 1950s to the 1980s has often been referred to as “The Age of Methods,” during which a number of quite detailed prescriptions for language teaching were proposed. Situational Language Teaching evolved in the United Kingdom while a parallel method, Audio-Lingualism, emerged in the United States. In the middle-methods period, a variety of methods were proclaimed as successors to the then prevailing Situational Language Teaching and Audio-Lingual methods. These alternatives were promoted under such titles as Silent Way, Suggestopedia, Community Language Learning, and Total Physical Response. In the 1980s, these methods in turn came to be overshadowed by more interactive views of language teaching, which collectively came to be known as Communicative Language Teaching (CLT). Communicative Language Teaching advocates subscribed to a broad set of principles such as these:

- Learners learn a language through using it to communicate.
- Authentic and meaningful communication should be the goal of classroom activities.
- Fluency is an important dimension of communication.
- Communication involves the integration of different language skills.
- Learning is a process of creative construction and involves trial and error.

However, CLT advocates avoided prescribing the set of practices through which these principles could best be realized, thus putting CLT clearly on the approach rather than the method end of the spectrum.

Communicative Language Teaching has spawned a number of off-shoots that share the same basic set of principles, but which spell out philosophical details or envision instructional practices in somewhat diverse ways. These CLT spin-off approaches include The Natural Approach, Cooperative Language Learning, Content-Based Teaching, and Task-Based Teaching.

It is difficult to describe these various methods briefly and yet fairly, and such a task is well beyond the scope of this document. However, several up-to-date texts are available that do detail differences and similarities among the many different approaches and methods that have been proposed. (See Larsen-Freeman, and Richards and Rodgers.) Perhaps it is possible to get a sense of the range of method proposals by looking at a synoptic view of the roles defined for teachers and learners within various methods. Such a synoptic (perhaps scanty) view can be seen in the following chart.

Teaching Methods and Teacher and Learner Roles		
Method	Teacher Roles	Learner Roles
Situational Language Teaching	Context Setter Error Corrector	Imitator Memorizer
Audio-lingualism	Language Modeller Drill Leader	Pattern Practicer Accuracy Enthusiast
Communicative Language Teaching	Needs Analyst Task Designer	Improviser Negotiator
Total Physical Response	Commander Action Monitor	Order Taker Performer
Community Language Learning	Counsellor Paraphraser	Collaborator Whole Person
The Natural Approach	Actor Props User	Guesser Immerser

Figure 2. Methods and Teacher and Learner Roles

(From: *Language Teaching Methodology* by Theodore S. Rodgers, Professor Emeritus, University of Hawaii)

The **Total Physical Response (TPR)** teaching method is one in which students respond with physical activity to an increasingly complex set of commands. The students' physical activity responses signal their comprehension of the command. This is ideally suited for beginning language students, but can be adapted and made more complex for higher level students.

The **Natural Approach (NA)** promotes communicative proficiency by providing real-world, authentic experiences, and language experiences with meaningful contexts.

As suggested in the chart, some schools of methodology see the teacher as an ideal language model and commander of classroom activity, whereas others see the teacher as a background facilitator and classroom colleague to learners.

There are other global issues to which spokespersons for the various methods and approaches respond in alternative ways. For example, should second language learning by adults be modelled on first language learning by children? One set of schools (e.g., Total Physical Response, Natural Approach) notes that first language acquisition is the only universally successful model of language learning we have, and thus that second language pedagogy must necessarily model itself on first language acquisition. An opposed view (e.g., Silent Way, Suggestopedia) observes that adults have different brains, interests, timing constraints, and learning environments than do children, and

that adult classroom learning therefore has to be fashioned in a way quite dissimilar to the way in which nature fashions how first languages are learned by children.

Another key distinction turns on the role of perception versus production in early stages of language learning. One school of thought proposes that learners should begin to communicate, to use a new language actively, on first contact (e.g., Audio-Lingual Method, Silent Way, Community Language Learning), while the other school of thought states that an initial and prolonged period of reception (listening, reading) should precede any attempts at production (e.g., Natural Approach).

A Post-communicative Approach to Teaching and Learning International Languages

The diversity of methods and approaches that were described above may seem to suggest that what makes for good practice is a contested area. However, one finds that there is an increasing integration of ideas as to what constitutes effective and meaningful second language teaching and learning. Krashen's theory that second language learners "acquire" language skills in many of the same ways that first language learners develop linguistic knowledge has had an enormous influence on second language/international language theory and practice. Proponents of communicative approaches have had an equally powerful influence. In many ways, the contemporary international language teacher reflects a "post-communicative" approach to teaching. That is, their understanding of the teaching and learning draws significantly on communicative theory but incorporates other theoretical perspectives, such as multiple intelligences and constructivist theories.

Communicative Language Teaching*

Renate Schulz provides a historical background and description of Communicative Language Teaching (CLT). In the 1970s and 1980s, second/international language instruction moved away from an almost exclusive focus on the components of language—grammar, vocabulary, and pronunciation—to a focus on the development of communicative proficiency—the ability to communicate in the target language (language being studied) in real-life contexts. Communicative language teaching builds on the understanding that language use is governed not only by phonological and grammatical rules, but also by sociolinguistic and discourse rules (Canale and Swain). In other words, natural language use is a complex, creative activity that takes different

* Adapted from "Foreign Language Education in the United States: Trends and Challenges" by Renate A. Schulz.

forms depending on a variety of factors, including the context in which the interaction occurs, the characteristics of the speaker or writer (e.g., age, gender, social status, level of education, and geographic origin), the characteristics of the listener or reader, and the purpose of the interaction (Hymes).

Whereas previous second/international language teaching methods—such as the grammar translation and audio-lingual methods—focused predominantly on grammatical form within a sentence-level context (or sometimes without any meaningful context), communicative language teaching focuses on the meaning of a message within a given situation, realizing that different cultures may have different ways to perform different speech acts in different contexts. It is the context that determines what is said, how it is said, to whom it is said, and why it is said. Thus communicative language teaching often uses language functions or speech acts (e.g., asking questions, apologizing, complimenting, reporting, giving directions, and making requests), rather than specific grammatical structures, as its organizing principles.

With the communicative language teaching approach, teachers and students use the target language extensively, if not exclusively. Students are given information-exchange tasks that they can complete by working in pairs or small groups. This interactive, situational language practice requires learners “to interpret, express, and negotiate meaning in the new language” (Lee and VanPatten 1).

Communicative language teaching also advocates the use of culturally authentic texts written by native speakers for native speakers instead of simplified or edited texts developed expressly for second/international language learners. Effective use of authentic texts includes having the learners perform interesting and level-appropriate tasks after or while seeing, hearing, or viewing culturally authentic materials. For example, it would be inappropriate to give beginning learners a newspaper editorial and ask them to translate or summarize its content. However, even beginning learners can find dates and names of persons or places and can often get the general sense of what is being said.

Although discrete-point grammar instruction, mechanical pattern practice, and instant and direct error correction—which dominated second/international language instruction in the past—are generally frowned upon in the communicative classroom, attention to grammatical patterns continues to play an important role. This is true particularly for adolescent and adult learners, who are often intrigued by—and find it helpful to understand—structural differences between their own and the target language. The role of grammar is to support the exchange of meaning, the informational contents, and the communicative purposes dealt with in the classroom.

Constructivist Theory

Constructivist theory emphasizes the importance of the learner's active construction of knowledge and the interplay between new knowledge and the learner's prior knowledge. Effective international language instruction will provide opportunities for students to construct and create their own understanding of how to make meaning from what they hear and read, and how they use their understanding to construct and create their own meanings in speech and writing. Myriam Met ("Middle Schools") describes a constructivist approach to the learning of international languages in the text that follows:

In order to construct knowledge of a new language, students need exposure to the target language. This exposure makes the transmission of meaning in second languages accessible and understandable to students. Internalizing the relationship between meaning and the forms used to convey it is essential for production; students cannot spontaneously produce language they do not understand. In the first phase of internalization, students learn to understand what is heard by matching meaning with language. Learners need to notice features in the input (vocabulary, syntax, discourse markers) to which they can assign meanings. Through a carefully implemented sequence of instructional activities, students can be assisted to move through the construction of meaning. Students should be provided with comprehensible examples of new structures as used in authentic situations and extended spoken and written texts, as well as many opportunities to hear, understand, and match language with meaning.

Characteristics of Effective Programs

It is well known that almost all young children acquire their first language naturally in the course of normal development and that they can acquire a second language simultaneously if their second language environment is similar to that of their first language environment. Numerous research studies have shown that adolescents and young adults can be quite efficient language learners (again with the exception of acquiring native-like pronunciation) in situations in which exposure to the language is limited to a classroom setting. As Swain and Lapkin ("Canadian Immersion") point out, "Older learners may not only exhibit as much success in learning certain aspects of a second language as younger learners, but they can also accomplish this learning in a shorter period of time" (150).

There are several factors or characteristics of effective second/ international language programs. In a review of the international literature on effective languages programming, Pufahl, Rhodes, and Christian (*Other Countries*) identified and summarized a number of additional factors or characteristics of successful program models.

An Early Start

As can be expected, time is a factor. Many international respondents reported that beginning language study early promotes achievement of higher levels of language proficiency. Seven of the countries that were studied have widespread or compulsory education in second/international languages by age eight, and another eight countries introduce second/international languages in the upper elementary grades. In many cases, a second second/international language is offered or required in the elementary grades. What is essential for the development of a lasting and usable competence in a second/international language is a lengthy, well-articulated, high-quality instructional sequence. This means that if language proficiency is the major goal of instruction, then the length of formal language study needs to be four years or more.

A Well-Articulated Framework

Instruction must be well-articulated in a continuous, sequentially planned and executed curriculum through which students progress without interruption from the beginning of their second/international language study to high school graduation. Several respondents noted the importance of a well-articulated curriculum framework that motivates and guides the development of an effective system of second/international language education. Many European countries have adapted their second/international language teaching at the national level to the frameworks and standards articulated by the Council of Europe's language policy and activities. *A Common European Framework of Reference for Languages*, developed and revised over the past decade, has had high impact. The *Framework* is a planning instrument that provides a common basis and terminology for describing objectives, methods and approaches, skills, practices, and assessments in language teaching, and it is used for planning syllabuses, examinations, teaching materials, and teacher training programs throughout Europe.

Similar developments have emerged in Canada and the United States. *The Western Canadian Protocol, Common Curriculum Framework for International Languages* (2000) was an attempt to improve the effectiveness of international language education in western Canada by providing a common well-articulated framework for the development of language-specific curriculum.

Rigorous Teacher Education

One of the most often cited factors related to excellence in second/international language education is a well-trained teaching corps.

Comprehensive Use of Technology

Innovative technologies and media are frequently cited as a way to increase access to information and entertainment in a second/international language, provide interaction with speakers of other languages, and improve second/international language teaching in the classroom.

Access to Information and Entertainment

Most respondents, in particular those from Canada, Denmark, and Thailand, highlighted the importance of the Internet and specialized databases for information retrieval. In smaller countries, many television shows are broadcast in a second/international language and subtitled rather than dubbed. In Denmark, where English is omnipresent through the many American and British television programs, films, computer games, and music videos, teachers have developed successful strategies for integrating students' informal second/international language exposure into classroom teaching.

Interaction and Collaboration with Speakers of Other Languages

Access to information on the World Wide Web and the use of new information technologies, especially networked computers, has contributed to increased communication among second/international language teachers and students in many countries. Through email, mailing lists, discussion groups, and chat rooms, the Internet has increased access to and communication in the second/international language with both native and non-native speakers.

In addition, improvements in travel and reduced costs have made it possible for increased direct contact through tourism, education, and business/work-related activities. Satellite communication and improvements in telecommunication have brought the "world" into homes throughout the world, no matter how remote. Multilingual television channels have increased the linguistic diversity in every nation.

Effective Teaching Strategies

Respondents mentioned several innovative methods for language instruction, which fall roughly into the categories highlighted below.

Integration of Language and Content Learning

Learning content-area subjects through the medium of a second/international language has become increasingly popular in many of the responding countries. In some cases, a second/international language is used as the medium of instruction in non-language subjects, frequently at the secondary school level when students have acquired sufficient proficiency in the second/international language. In Luxembourg, for example, both German and French are used as a medium of instruction throughout students' school careers to support simultaneous learning of both languages. In immersion programs, called "bilingual programs" in Europe, primary school children are taught subject matter almost exclusively in a second or international language. Similar bilingual and French immersion programs in Canada have demonstrated the possibilities and effectiveness of each model.

Communicative Teaching Methods

In Denmark, Germany, the Netherlands, New Zealand, Peru, and Spain, a focus on communicative and intercultural learning has not only stimulated a productive discussion of teaching objectives, methods, and underlying rationales that are now reflected in curricula and textbooks, but has also resulted in increased oral and written proficiency for their students.

Focus on Language Learning Strategies

Several respondents reported that a recent focus on how to learn a second/international language has been important to the success of language education in their countries. In Denmark, for example, teachers focus on raising students' awareness of various communication strategies, including strategies to bridge vocabulary gaps, reading and listening strategies, and general language learning strategies.

Building on the First or Subsequent Languages

There is increasing awareness and knowledge of the importance of the students' first language on second language learning. Successful approaches consider students' first languages as a foundation upon which to build second language proficiency. In Luxembourg, several projects demonstrate that acknowledging the sociocultural context and the already developed competencies of children in their first language will boost learning of subsequent languages.

Other Characteristics of Successful Programs

Other notable methods include the sole use of the second/ international language in the classroom; a modular approach to teaching in which students are grouped according to proficiency level rather than age or grade level; and project-oriented learning that emphasizes the use of authentic materials through technology and integrates learning about culture and nations with language and content learning.

The Influence of Contemporary Theory and Practice on the WNCP

The research summarized in the preceding section has informed the development of the WNCP *Spanish Language and Culture, Six-Year Junior/Senior High School Program: Implementation Manual*. In developing this document, developing communicative competence has been at the forefront of the enterprise. Both the curriculum framework and the suggestions for instruction and assessment included in this manual demonstrate an acute awareness of the importance of meaningful and relevant learning experiences and tasks, which provide a context for acquiring and using Spanish.

Four Components

Communicative competence is represented by four interrelated and interdependent components. The “Applications” component deals with what the students will be able to do in Spanish, the functions they will be able to perform, and the contexts in which they will be able to operate. “Language Competence” addresses the students’ knowledge of the Spanish language and their ability to use that knowledge to interpret and produce meaningful **texts*** appropriate to the situation in which they are used. “Global Citizenship” aims to develop intercultural competence with a particular focus on Spanish cultures. The “Strategies” component helps students learn and communicate more effectively and more efficiently. Each of these components is described more in the *The Common Curriculum Framework for Spanish Language and Culture, Six-Year Junior/Senior High School Program* and also in this document.

Modes of Communication

Because of the focus on using language to communicate in specific contexts, with a particular purpose or task in mind, three modes of communication are used to organize some of the specific outcomes rather than the traditional language arts (reading, writing, listening, speaking, viewing, representing).

* See Appendix A: Glossary for definitions of terms.

Interaction is most often direct, face-to-face oral communication. It can also take the form of written communication between individuals using a medium such as email where the exchange of information is fairly immediate. It is characterized principally by the opportunity to negotiate meaning actively. Negotiating meaning involves working to make oneself understood and to understand others. Interactive communication generally requires more speed but less accuracy than the other two modes.

Interpretation is receptive communication of oral and written messages in contexts where the listener or reader is not in direct contact with the creator of the message. While there is no opportunity to ask for clarification, there is sometimes the possibility of rereading or listening again, consulting references, or figuring out meaning in other ways. Reading and listening will sometimes involve viewing and interpreting visual elements such as illustrations in books or moving images in television and film. Interpretation goes beyond a literal comprehension to include an understanding of some of the unspoken or unwritten meaning intended by the author or speaker.

Production is communication of oral and written messages in contexts where the audience is not in personal contact with the speaker or writer, or in situations of one-to-many communication (e.g., a lecture or a performance where there is no opportunity for the listener to interact with the speaker). Oral and written presentations will sometimes be enhanced by representing the meaning visually, using pictures, diagrams, models, drama techniques, or other non-verbal forms of communication. Greater knowledge of the language and culture is required to ensure that communication is successful because the participants cannot directly negotiate meaning.

Viewing and Representing

It is common in Canada to conceptualize language arts as comprising six elements (reading, writing, speaking, listening, viewing, and representing). While the six language arts cannot be separated in a real sense in the classroom, viewing and representing are discussed separately here because they have been formally identified as language arts in this curriculum.

Many students are avid and sophisticated consumers of visual media, and their familiarity with visual forms may facilitate literacy with other forms. Teachers can make use of this knowledge by creating links between conventions in visual media and similar conventions in written texts.

Viewing and representing are language arts in their own right. Students need to learn the techniques and conventions of visual language to become more conscious, critical, and appreciative readers of visual media, and more effective creators of visual products.

Films and video productions increase students' experiences, much as written texts do, and they offer similar opportunities for discussion. Films also provide rich opportunities to explore the similarities and differences between visual and written language. Students may enhance their own products and presentations by using visuals with written text and/or sound.

Students may use visual representation for both informal and formal expression. Drawing or sketching may, in fact, be the first and most natural way for some students to clarify thinking and generate ideas. They may also use tools such as frames, maps, webs, and other graphic organizers to comprehend parts and their relationships. Visual tools are especially useful because they can represent the non-linear nature of thought and show relationships among ideas. For beginning learners of Spanish Language and Culture, visual tools may be an effective way to facilitate and demonstrate comprehension.

Students may use representation to express their mental constructs of the ideas, theories, or scenes in written texts. Events, ideas, and information may be depicted in graphic organizers, storyboards, murals, comic strips, or collages. After studying visual media, students make informed use of design elements in developing charts, slides, posters, and booklets. Other creative forms of expression, such as music, drama, dance, or mathematics, can be a means of representing students' understanding of a topic or a concept. The inclusion of representing as a language art extends the means by which students can communicate and demonstrate their learning in authentic ways.

Three Types of Language Learning

As students actively use the language arts, they engage in three kinds of language learning:

- Students learn language: Language learning is a social process that begins in infancy and continues through life. Language-rich environments enhance and accelerate the learning process.
- Students learn through language: As students listen, read, or view, they focus primarily on making meaning. Students use language to increase their knowledge of the world.
- Students learn about language: Knowledge of how language works is a subject and a discipline in itself and is fundamental to effective communication.

These three kinds of language learning are integrated in the classroom. Students may engage in learning tasks principally to make sense of the world. In the process of learning through language, however, their facility with language and their knowledge about language increases.

Developing Language Competence

Language competence is a broad term which includes not only knowledge about the language, but also the ability to use that knowledge to interpret and produce meaningful texts appropriate to the situation in which they are used. Language competence is best developed in the context of activities or tasks where the language is used for real purposes, in other words, in practical applications. Tasks involve students in understanding, manipulating, producing, or interacting in Spanish while their attention is principally focused on meaning rather than form. Activities or tasks will be chosen based on the needs, interests, and experiences of students. The vocabulary, grammar structures, text forms, and social conventions necessary to carry out the task will be taught, practised, and assessed as students are involved in various aspects of the task itself, not in isolation.

Teaching the Form of the Language

Teaching the form of a second language has been the topic of much discussion but there is still a need for more research to clarify many issues that remain unresolved. However, we can make the following observations with some certainty:

- Exposing students to the language without explicitly teaching its structures and formal properties is not enough to enable most students to become fluent.
- Teaching grammar through exercises that are unrelated to meaningful communication will not help students improve their language competence.
- Activities or tasks which focus on the form of the language should take up a relatively small part of the overall class time. The majority of classroom time should be spent on communicative activities, in other words, on activities where the focus is on meaning.
- Students cannot be expected to master a particular structure after a single lesson on it. They need to be exposed to the structure repeatedly, in a variety of situations, and have the opportunity to use it over an extended period of time before it will be learned.

How does the teacher decide when to introduce specific structures or forms? In programming that takes a task-based or content-based approach, the choice of grammar structures or forms to work on explicitly is based on the immediate needs of the students. In other words, students learn about the structures and forms they will need to use in order to carry out the task that is the focus of the unit. This way

of ordering the teaching of grammar requires a careful analysis of the tasks the students will work on to determine which structures are essential and in which context they will be used. With careful planning, the teacher can ensure that specific points are revisited regularly in a variety of contexts.

An effective method of raising the students' consciousness of particular structures or rules is to help them discover the rule themselves. Once they are aware of the structure, they will be more likely to notice it in texts they are working with and thus have their learning reinforced. Grammatical problem-solving activities (see page 68) can be used to help students discover patterns from a number of examples of correct and incorrect sentences. If students work in pairs or small groups and are able to do the activity in Spanish, they will also be getting an opportunity to use the language in an authentic situation, in this case to learn something new. Even if students do the activity in English and are guided by the teacher, they will still benefit from the analysis.

Structural exercises can be effective tools for teaching grammar provided they meet certain criteria:

- Sentences used for the exercises should be taken directly from students' own productions or from texts they are using in their communicative activities.
- Understanding the meaning of the sentence should be necessary in order to do the exercise.
- Students should have the opportunity to use the structure they have just analyzed to accomplish the task that is the focus of the unit.

See the section on Instructional Methods for more specific details and examples of structural exercises (page 51).

Teaching Aural Interpretation

Stephen Krashen's theory of second language acquisition (*Principles and Practice*) emphasizes the importance of comprehensible input. Students must hear the language spoken in situations which help them understand what is being said if they are to acquire the language. They may go through a "silent period" before being willing to try to use the language themselves, but this does not mean that they are not learning.

To maximize acquisition of the Spanish language, especially in the very early stages, input should have the following characteristics:

- Texts are as authentic as possible. (Authentic means they were produced for speakers of Spanish and not for second language learners.)
- Speech is slower and more clearly articulated, although not distorted.

- Syntax is simple, sentences short.
- High frequency vocabulary is used.
- The meaning is clarified by the use of gestures, facial expressions, visuals, or concrete objects.
- The topic is familiar to the student.
- The content is interesting and/or relevant to the student.

As students become more proficient, the language to which they are exposed can more closely resemble the normal speech of a native speaker and the non-verbal supports can be reduced. In order for students to continue to learn, input should always be just a little beyond their current capabilities.

Since the Spanish classroom may be the only place students are exposed to the language, it is important that Spanish be used as much as possible. Students can gradually be taught the vocabulary and structures needed to carry out classroom routines in Spanish, until the whole class is taking place in the second language.

Teaching Oral Production

Oral production activities are distinct from activities where there is interaction (and the possibility of negotiation of meaning) between individuals. Even though they are not interactive, they must still be communicative. This means that they will have the following characteristics:

- The topic is interesting and/or relevant to the students.
- The student producing the text has a **real** purpose (e.g., sharing factual information, expressing a personal opinion).
- The text is presented to a **real** audience (a person or persons other than a teacher who is listening for the sole purpose of teaching and assessing the student).
- **Real** communication takes place; in other words, the audience does not already know what the speaker is telling them.
- The students presenting the text usually have an opportunity to plan and prepare what they are going to say beforehand and to rehearse their presentation. For this reason, greater accuracy, better pronunciation and intonation, and greater fluency can be expected than in interactive situations.

Developing Interactive Fluency

Research has shown that students need more than comprehensible input to learn a second language. They also need output; in other words, they need opportunities to interact with others and to try to make themselves understood, if they are to develop accuracy and fluency. Producing language helps learners to notice gaps in their knowledge and then to try to find the correct form, in order to be understood.

Studies have also shown that nearly two-thirds of the talking that goes on in classrooms is done by the teacher. This is rather alarming when we know that interaction is essential for learning a language. If the teacher controls dialogue by asking questions of one student at a time, each individual student will have very little opportunity to try out new vocabulary and structures. Students must have the opportunity to interact in Spanish in authentic situations as much as possible.

Face-to-face interaction is different from other situations (e.g., reading a story, writing a letter, listening to a song, speaking to a group) in that negotiation of meaning is possible. The speaker knows more or less immediately whether or not the message has been understood. The conversational partner may indicate lack of understanding, ask for clarification, or simply respond, thinking they have understood. This back and forth process continues until a mutual understanding has been reached.

However, interactive activities, if they are to be effective, cannot be left to chance. They must be carefully planned and structured. Here are some suggestions:

- By using cooperative mixed-level groups, the teacher provides students with many opportunities to express themselves, to use the language in communicative situations, and to test their ability to get their message across. It is important to teach and assess cooperative skills related to using the Spanish language in cooperative groups. A more detailed description of cooperative learning can be found in the section on instructional methods (page 72).
- Students can be taught strategies for making themselves understood, without having recourse to English, when they don't know or cannot remember a word or phrase. Strategies include using gestures, synonyms, paraphrasing, looking at word lists posted in the classroom, and so on. See the list of interactive strategies in Appendix E, page Appendices – 35.

- Students often need to be encouraged to be a little more precise, a little more accurate. However, in interactive activities the focus should remain on the meaning the student is trying to convey. It is possible to respond to the message and yet push students to improve their language. If they are using a general word, for example, respond to what they are saying while at the same time using a more precise word. If they make a mistake in grammar or pronunciation, respond to the content (the meaning) of their message, but incorporate the correct structure or pronunciation into your response. If the idea is vague or very general, ask students to provide more details, justify their opinion, or be more precise.
- Students can learn to use similar techniques in their interactions with their fellow students. This involves strategies like asking questions to get more information or a clearer answer, indicating when one has not understood, or repeating what was said in a different way to check for understanding.
- None of these suggestions will work unless the classroom provides a safe environment for students, an environment where they know they can make mistakes without being ridiculed or punished. Students need to understand that taking risks (trying out new vocabulary and structures, using language that they are not quite sure of, trying to say things they want to say but have not yet learned fully) and making the inevitable mistakes are part of the process of effective language learning.

Teaching Written Interpretation

Students learning to read Spanish at the middle or secondary level have the advantage that they already know how to read in their first language and can transfer many of their skills and strategies to the task of reading Spanish, their second or additional language. The alphabet is the same. Students already understand that a written text has a message and that it is made up of individual words. They know that they don't always have to understand every word, they can read ahead and come back, or they can just guess at the meaning of words they don't know, and so on.

Since written language is a source of comprehensible input in the same way that oral language is, much of what was said about aural interpretation above is true of written interpretation as well. Written texts used in the early stages of learning Spanish should have the following characteristics:

- They are as authentic as possible. (Authentic means they were written for speakers of Spanish and not for second language learners.)

- Syntax is simple, sentences are short, texts are also short or made up of short sections.
- High frequency vocabulary is used.
- The meaning is clarified by the use of illustrations and other contextual clues.
- The topic is familiar to the student.
- The content is interesting and/or relevant to the student.

As students become more proficient, the written texts to which they are exposed can more closely resemble the normal language of a native speaker with fewer visual supports. In order for students to continue to learn, input should always be just a little beyond their current capabilities.

The term “written interpretation” is a reminder that the objective of reading is to interpret the meaning of the text. Activities such as reading aloud, while they have their place in the second language classroom, are more suited to practising good pronunciation or learning the correlation between sounds and spelling than to developing comprehension. For beginning readers of Spanish it is difficult to attend to the meaning of a text at the same time as the sound-symbol system.

Teaching Written Production

Research on teaching writing shows that student achievement is higher when the teaching approach emphasizes writing as a **process**, rather than writing as a **product**.

In the traditional **product-oriented approach**, form and correctness are the focus of attention. The teacher provides drills on specific skills, makes many of the major decisions for the students (e.g., topic, length, what form the text will take), and is the only audience. Students are asked to concentrate on following rules, to work alone, and to constantly pay attention to technical matters such as grammar and spelling. They usually write only one version of the text, which the teacher corrects. Because no one else will read the writing, students often pay little attention to the teacher’s comments.

Research has clearly shown that a concentration on grammar actually slows students’ development as writers because the insistence on correctness reduces their willingness to experiment and invent. Grammar instruction that relates directly to students’ writing, and is in response to their needs, is effective in improving writing.

The experience of classroom teachers and research conducted during recent years shows that a **process-oriented approach** to teaching writing is more successful. In this approach, students are led through a series of stages in their writing and gradually learn to use this process independently.

Strategic Learning in Spanish Language and Culture

Fostering strategic learning in the Spanish Language and Culture classroom is essential for ensuring effective and lifelong learning. To develop high levels of language skills, including literacy, students need instruction in the strategies that skillful learners use in approaching language tasks. Students need to be taught learning strategies through demonstration, explicit instruction, guided practice, and independent practice with feedback and support. Therefore, students in the WNCP Spanish Language and Culture Four-Year High School Program are encouraged to acquire and apply a wide range of strategies to enhance their learning and their ability to communicate effectively.

Strategies are systematic and conscious plans, actions, and thoughts that learners select and adapt to each task. Strategies are often described as knowing what to do, how to do it, when to do it, and why it is useful. The Spanish Language and Culture Program of Studies includes clusters of specific outcomes designed to promote three types of strategic learning in the Spanish Language and Culture classroom: language learning strategies, language use strategies, and general learning strategies.

Language learning strategies refer to actions taken by learners to enhance their own language learning. These strategies are subdivided into three categories: *cognitive*, *metacognitive*, and *social/affective*.

Cognitive language learning strategies operate directly on the language. These include such strategies as using different techniques for remembering new words and phrases, deducing grammar rules or applying previously-learned rules, guessing at the meaning of unknown words, and using a variety of ways to organize new information and link the new information to previously-learned language.

Metacognitive language learning strategies are higher order skills that students use to manage their own learning. These include planning for their language learning, monitoring their own language learning, and evaluating their success in language learning.

Social language learning strategies are actions learners take that involve interactions with native speakers of the Spanish language or interactions with other learners of Spanish in order to assist or enhance their own language learning. For example, asking another student for help to understand a text written in Spanish, or asking a native speaker for an unknown vocabulary item would be social language learning strategies.

Affective language learning strategies are methods students use to regulate their emotions, motivation, and attitudes to make themselves more conducive to learning.

Language use strategies are actions taken to enhance communication. These strategies are often used with no intention of trying to acquire language, but instead with the intention of improving communication. The language use strategies in *The Common Curriculum Framework for Spanish Language and Culture, Six-Year Junior/Senior High School Program* are organized according to the three communicative modes: *interaction, interpretation, and production*.

General learning strategies refer to actions taken by learners to enhance their own general learning. As with language learning strategies, general learning strategies are divided into three sub-categories: *cognitive, metacognitive, and social/affective*. There is a distinctive similarity between language learning strategies and general learning strategies; the determining difference, however, is whether the purpose of the application of the specific strategy is the learning of the language or of other concepts. Often, the other concepts include subject-area concepts, such as social studies or health concepts.

The strategies that students choose depend on the task they are engaged in as well as on other factors, such as their preferred learning style, personality, age, attitude, and cultural background. Strategies that work well for one person may not be effective for another person or may not be suitable in a different situation. For this reason it is not particularly useful to say that students should be able to use specific strategies at a particular grade level. The goal is to help students become more active, more self-directed, more autonomous, and more expert in choosing the strategies that work best for them. Effective language learners tend to use more strategies and to apply them in a more appropriate fashion than less effective learners. A global list of strategies that will benefit students can be found in Appendix E of this document.

Strategies should be introduced as they are needed. When strategies are introduced and explained in terms of their value to the learner and are demonstrated and practised over time, they can produce long-lasting, significant improvements in the students' ability to construct meaning, acquire language, and achieve the Spanish Language and Culture outcomes. All students benefit from strategic instruction, but individual students need varying degrees of support in learning and using strategies.

Inclusive Teaching Approaches

Every classroom is a diverse classroom. Students bring with them a rich array of cultural backgrounds, learning styles, personal interests, and characteristics. It is important for teachers to consider the needs of all the learners in the classroom. The charts that follow provide an overview of points to consider and useful strategies for adapting instruction for diverse students.

Balanced Instruction in Spanish Language and Culture

Planning for balance while ensuring sufficient instruction and practice in all the outcomes defined for a particular grade is a particularly challenging task. Teachers strive to incorporate a variety of instructional strategies and teaching and learning activities in their classrooms. This includes varying instructional groupings and methods to meet the learning needs of a wide range of students.

Teachers also strive to ensure balance in their delivery of the curricular outcomes. They are attentive to the need for integrating the Application, Language Competence, Strategies, and Global Citizenship outcomes to achieve balanced instruction. They are careful to provide instruction in linguistic elements, such as grammar or vocabulary, within the context of concrete applications.

Themes, integrated units, and learning sequences provide opportunities for explicit instruction in many outcomes. Instructional activities such as mini-lessons are necessary to introduce, develop, or reinforce particular skills. In every planning decision, reflective teachers ask:

- What is an appropriate balance for my students?
- Am I achieving that balance in my classroom, both in the short term and the long term?
- Is my instruction helping students to achieve the appropriate outcomes of the Spanish Language and Culture Program of Studies?

Teachers strive for balance in their classrooms. A communicative approach requires the teacher to be a guide and a language model. One of the main functions of the teacher is to discover or invent ways of encouraging students to communicate meaningfully with each other. Instead of actively directing and controlling all activities, the teacher will set up conditions for meaningful practice, and then take on roles such as observer, facilitator, resource person, catalyst, challenger, and encourager.

Teachers also endeavour to provide a range of learning materials and resources. It is important to provide many opportunities for students to interact with a wide range of oral, literary, and media texts, from varied sources. See Sample List of Text Forms in Appendix B.

A balance between classroom-centred experiences and real-life, authentic applications of the Spanish language focused outside the classroom is essential in preparing Spanish Language and Culture students for the world beyond the Spanish classroom. This can be achieved through a wide range of activities, such as interactions with guest speakers and other visitors from outside of the school community, pen pal experiences, exploring Internet sites, viewing Spanish television or film productions, etc. Similarly, students must be provided with a wide range of opportunities for using the Spanish language in meaningful ways.

Adaptation Strategies

“Differentiating the curriculum” refers to adjustments in content, teaching strategies, expectations of student mastery, and scope and sequence. The students work at different paces. Gifted students are more likely to develop study and production skills, experience success, and feel challenged by instruction that encourages learners to master information more quickly. General adaptation strategies to ensure success with these learners are found on page 35.

Strategies for the International Language Classroom

Suggested student adaptation strategies for the international language classroom may include, but are not limited to, the following:

- researching and discussing cultural issues/perspectives in more depth
- posing questions that involve inferencing and focusing on complex cross-curricular themes or global problems
- explaining reasons for taking a certain position or making a specific decision both orally and in writing in Spanish

- creating original songs, stories, short plays, poems, designs, etc., showing multicultural perspectives of a specific theme or having a futuristic twist
- being held accountable for additional listening comprehension tasks
- creating experiences and performances that reflect the results of research, interviews, or surveys in the target language
- retelling a story or experience from other content areas in the target language
- writing editorials, letters, etc. to Spanish newspapers in the United States
- emailing articles, commentaries, reviews, etc. to Spanish schools, publications, organizations, newspapers, or magazines
- being given assignments involving more sophisticated computer research and reporting in the target language
- receiving handouts, information for web searches, etc. in the target language
- processing a greater volume of any given print material
- being given the option of independent world language projects of choice

Adaptation Strategies For Selected Scenarios

“Making Connections”

- Based on the scenario interview, write an essay in Spanish projecting the guest speaker’s future. Focus on further development of vocabulary related to that career. Present orally as a commentary on the guest’s class visit.
- Write a prospective business plan for the guest based on knowledge of the speaker’s current business and the Spanish-speaking culture. Email the plan to the speaker.

“You Are What You Eat”

- Create a catering business in a Spanish-speaking country. Plan meals for business conferences and typical celebrations in the Spanish culture. Include prices and optional services offered.
- Create a new recipe for a Spanish-speaking culture that satisfies certain criteria (e.g., seasonal dishes, diet dishes, or a dish that might appeal to target culture teens).
- Do an independent project in related areas (e.g., manners for a changing society, diseases related to food consumption, or emotions associated with certain foods in a Spanish-speaking culture/ country).

“Dare to Say No”

- Create a perfect teen/parent for a Spanish-speaking culture. The “ideals” will be based on what the student considers to be the best resolutions to the problems identified as a result of the scenario activity.
- Create a support group for teens based on problems identified and act as “facilitator” for the group.
- Direct and produce a TV talk show entitled “Parents & Teens Around the Globe.” Students role-play parent and teen guests.

Types of Adaptations

Three types of adaptations for exceptionally able learners—acceleration, enrichment, and grouping—are described in this section.

Acceleration

Acceleration involves grade-skipping or changing the rate of presentation of the general curriculum to enable the student to complete the program in less time than usual. Prescribed seat-time is not necessary for achievement of the outcomes. Acceleration can occur in any subject area. Middle school students should be able to take high school courses; high school students take college courses with appropriate credit accrued. Some provision must be made for continued acceleration or high-level enrichment. Unless the student has a pre-identified problem, social or emotional development should not inhibit acceleration.

The following are some examples of accelerated types of programs:

- **Flexible Pacing:** Assignment to classes should be based on the ability to be challenged and handle the work, not on age.
- **Content Acceleration:** Superior performance in some areas may be addressed with placement in a higher grade level for the areas warranting it.
- **Multi-Age Classes:** Classes can be formed in which two or more grade levels are combined. Students can accelerate through self-pacing.
- **Compacting** (also known as telescoping): This refers to a form of acceleration in which part of the curriculum is addressed in a shorter period of time than is usual. Previously mastered content material is determined through pre-evaluation and eliminated.

- **College Course Work:** Qualified students take college courses for college credit while completing high school requirement (concurrent enrollment). College courses may be taken in the summer.
- **Early College Admission:** Once all high school graduation requirements are met, early admission to college is an option.
- **Advanced Placement:** The advanced placement program (APP), administered by the College Entrance Examination Board, enables high school students to obtain both high school and college credit for demanding course work offered as part of the school curriculum.

Enrichment

Enrichment is another way to meet the differentiated needs of exceptionally able students. Well-articulated assignments that require higher cognitive processing, in-depth content, and alternate modes of communication can be effective and stimulating.

The following are some examples to consider when differentiating classroom instruction to meet the needs of academically or artistically talented students:

- **Alternate Learning Activities/Units:** Opportunities to pursue alternate activities permit students to engage in new learning and avoid the boredom of repeating instruction or unnecessary practice in skills already mastered.
- **Independent Study:** Students conduct well planned, self-directed research projects carefully monitored by the teacher. Prerequisites include instruction in field-based and library research skills, the scientific method, and other authentic types of inquiry.
- **Advanced Thinking Processes:** Assignments in all curriculum areas should emphasize higher-level thinking skills such as synthesis, analysis, and evaluation.
- **Guest Speakers:** University faculty, parents, business and industry leaders, or other teachers in specific fields can provide information on topics beyond the teacher's expertise.
- **Mentors/Internships:** Both mentors and internships allow students to interact with adult experts in fields of mutual interest and increase awareness of potential careers. Mentors act as role models.
- **Alternate Resources:** This category may include materials from a higher grade level or access to business, university, and community resources such as laboratories, libraries, and computer facilities.

- **Exchange Programs:** Students attend schools in a different community or country to enrich educational experiences.

Grouping

Grouping involves placing students of like ability together in homogeneous arrangements such as special classes or clustering in the same classroom. Grouping allows for more appropriate, rapid, and advanced instruction and challenges students without isolating them.



Students may be grouped using the following arrangements:

- **Pullout Programs:** These programs combine regular class integration and homogeneous grouping on a part-time, regular basis. Pullout programs require careful coordination and communication between the teachers of both classes.
- **Cluster Grouping in the Regular Classroom:** This type of grouping permits homogeneous and heterogeneous grouping according to interests and achievement.
- **Cluster Scheduling:** Schedules are arranged so that exceptionally able students can take their required core courses together to enhance rapid pacing and provide greater depth and breadth to course content.
- **Honours and Enriched Classes:** These classes provide opportunities for practising higher-level thinking skills, creativity, and exploration of in-depth course content.
- **Seminars:** Aimed at research, interdisciplinary studies, visual and performing arts, academic subjects, or other areas of interest, seminars provide interaction with specialists who can give guidance in specific areas.
- **Resource Centres:** A district can establish a resource centre available to all students, but reserve it at times for exceptionally able students from a broader geographical area (e.g., inter-district).

Additional Adaptations



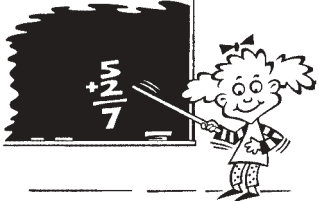

The following charts outline various strategies for adapting learning activities to accommodate students with diverse talents, exceptionally able students, and students with specific learning needs. Teachers may wish to refer to these during their instructional planning and as a check to be sure that they are using inclusive classroom practices.

STRATEGIES FOR STUDENTS WITH DIVERSE TALENTS

Intelligence	Students learn best by	Planning questions for teachers	Learning activities
<p>Linguistic</p> 	Verbalizing, hearing, and seeing words	How can I use the spoken or written word?	Creative writing Formal speech Humour or telling jokes Impromptu speaking Journal or diary keeping Oral debate Poetry Storytelling Words—used in reading, writing, speaking
<p>Logical-Mathematical</p> 	Conceptualizing it, quantifying it, thinking critically about it	How can I bring in numbers, calculations, logic, classifications, or critical-thinking skills?	Abstract symbols, formulas Calculation Counting Deciphering codes Finding patterns Forcing relationships Graphic organizers Number sequences Outlining Problem solving Syllogisms
<p>Spatial</p> 	Drawing it, sketching it, visualizing it	How can I use visual aids, visualization, colour, art, or metaphor?	Active imagination Colour schemes Designs and patterns Drawing guided imagery Mind mapping Painting pictures Pretending Sculpture/models
<p>Bodily-Kinesthetic</p> 	Dancing it, building a model of it, doing a hands-on activity related to it	How can I involve the whole body or use hands-on experience?	Body language Dancing—folk or creative Drama/acting Inventing Martial arts Mime Physical gestures Physical exercises Playing sports and games Role-playing

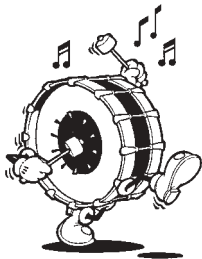
Adapted from the *Nebraska K-12 Foreign Language Frameworks*

STRATEGIES FOR STUDENTS WITH DIVERSE TALENTS (CONTINUED)

Intelligence	Students learn best by	Planning questions for teachers	Learning activities
<p>Music</p> 	<p>Singing it, chanting it, finding music that illustrates it, putting on background music while learning it</p>	<p>How can I bring in music or environmental sounds, or set key points in a rhythmic or melodic framework?</p>	<p>Creating music Environment sounds Humming Listening to music Music performance Music composition, creation Percussion vibrations Rhythmic patterns Singing Tonal patterns Vocal sounds and tones</p>
<p>Interpersonal</p> 	<p>Working on it with another person or group of people</p>	<p>How can I engage students in peer-sharing, cooperative learning, or large-group simulation?</p>	<p>Collaboration skills Cooperating Cooperative learning Empathy practices Giving feedback Group projects Intuiting others' feelings Listening Person-to-person communication Receiving feedback Sensing others' motives Talking to others Teamwork/division of labour</p>
<p>Intrapersonal</p> 	<p>Relating to a personal feeling or inner experience</p>	<p>How can I evoke personal feelings or memories, or give students choices?</p>	<p>Being alone Complex guided imagery "Centring" practices Emotional processing Focusing/concentration skills Higher-order reasoning "Know thyself" practices Metacognition techniques Mindfulness practices Silent reflection methods Telling about feelings Telling about thinking Thinking strategies</p>
<p>Naturalist-Physical World</p> 	<p>Observing it, classifying it, appreciating it</p>	<p>How can I relate the student's learning to the physical world?</p>	<p>Discovering, uncovering Observing, watching Forecasting, predicting Planting Comparing Displaying Sorting and classifying Photographing Building environments</p>

Adapted from the *Nebraska K-12 Foreign Language Frameworks*

STRATEGIES FOR STUDENTS WITH DIVERSE TALENTS

Multiple Intelligences Grid of Ideas The Olympic Games or Games of Life							
Verbal	Logical	Spatial	Bodily	Musical	Interpersonal	Intrapersonal	Naturalist
Biographies	Graphic arts	Greek architecture	Fitness	National songs	Teamwork	Individual achievement	Nutrition
Writing about heroes	Biochemistry	Pottery	Sports	Raps	Cooperation	Pride	Health
Historical fiction	Laws of physics	Painting	Practice	Practising music	Competition	Sense of accomplishment	Wellness
Myths	Statistics	Posters	Routines	Relaxation music	Sportsmanship	Logs	Biochemistry
Literature	Percentages	Photos	Regimens	Mediation	Coaching	Journals	Climate
News reporting	Logical thinking	Graphic organizers	Physical therapy	Composing	Mentoring	Psychology of peak performance	Culture
Expository writing	Sequences	Graphs	Conditioning	Performing	Global relationships		Biofeedback
Features	Cause/effect	Visualization techniques	Experiences	Selecting appropriate music	Conflict management	Endurance	Attitudes

Multiple Intelligences Grid of Life (Fogarty)

**STRATEGIES FOR STUDENTS WITH DIVERSE TALENTS
PLANNING MODEL USING BLOOM’S TAXONOMY**

Bloom’s Taxonomy is a model that focuses on six levels of thinking. The six levels roughly form a two-tiered arrangement that represents levels of complexity in thinking. Knowledge and comprehension are the lower or more concrete levels of thinking. Analysis, evaluation, and synthesis represent higher or more complex levels of thinking. The application level, which falls between the lower and higher levels, can be very complex depending on the task.

A variety of instructional strategies and products may be categorized for each level of thinking. Teachers who design a variety of learning activities that require different levels of thinking will provide appropriate opportunity for the diverse number of students whose thinking levels range throughout the spectrum.

The following chart provides a model for instructional planning based on Bloom’s taxonomy of thinking. Also see International Languages and Bloom’s Taxonomy on page 34.

Level	Definition	Instructional Strategies	Activities, Tasks, & Products
Lower, less complex, more concrete levels	Knowledge	<ul style="list-style-type: none"> • ask • define • describe • discover • identify • label • list • listen • locate • match • memorize • name • observe • recite • recognize • remember • research • select • state • tell 	<ul style="list-style-type: none"> • books • diagrams • events • exams • facts in isolation • films • film strips • magazine articles • models • newspapers • people • plays • quiz • radio • recordings/records • tapes • tape reading • vocabulary • workbook pages
	Comprehension	<ul style="list-style-type: none"> • ask • change • compare • convert • defend • discover • distinguish • edit • explain • express • extend • generalize • give example • identify • illustrate • infer • interpret • listen • locate • match • observe • paraphrase • predict • relate • research • restate • rewrite • show symbol • summarize • transform • translate 	<ul style="list-style-type: none"> • causal relationship • comparison of like/unlike items • conclusion/implication based on data • diagrams • films • filmstrips • graph • magazines • models • newspapers • outline • own statement • people • photograph • radio • response to questions • revisions • skit • speech • story • summary • tape recording • television

Adapted from the *Nebraska K-12 Foreign Language Frameworks*

STRATEGIES FOR STUDENTS WITH DIVERSE TALENTS (CONTINUED)
 PLANNING MODEL USING BLOOM'S TAXONOMY

Level	Definition	Instructional Strategies	Activities, Tasks, & Products	
Higher, more complex, more abstract levels	Application	Students apply the information in one or more contexts	<ul style="list-style-type: none"> • apply • build • change • choose • classify • construct • cook • demonstrate • discover • dramatize • experiment • interview • list • manipulate • modify • paint • prepare • produce • record • report • show • sketch • solve • stimulate • teach • use guides, charts, maps 	<ul style="list-style-type: none"> • artwork • collection • crafts • demonstration • diagram • diorama • diary • drama • forecasts • illustration • list • map • meeting • mobile • model • paint • photographs • project • puzzle • question • recipe • scrapbook • sculpture • shifting smoothly from one gear into another • solution • stitchery
	Analysis	Students understand component parts to be able to compare and contrast or categorize information	<ul style="list-style-type: none"> • advertise • analyze • categorize • classify • compare • contrast • differentiate • dissect • distinguish • infer • investigate • point out • select • separate • solve • subdivide • survey 	<ul style="list-style-type: none"> • argument broken down • chart • commercial • conclusion • checked • diagram • graph • parts of propaganda statement identified • plan • prospectus • questionnaire • report survey • report • solution • survey • syllogism broken down • word defined
	Synthesis	Students judge what they have analyzed and support their opinions	<ul style="list-style-type: none"> • combine • compose • construct • create • design • estimate • forecast • hypothesize • imagine • infer • invent • predict • produce • rearrange parts • role-play • write 	<ul style="list-style-type: none"> • advertisement • article • book • cartoon • experiment • formation of a hypothesis or question • game • invention • lesson plan • machine • magazine • new game • new product • new color, smell, taste • news article • pantomime • play • poem • puppet show • radio show • recipe • report • set of rules, principles, or standards • song • speculate on or plan alternative courses of action • story structure • television show
	Evaluation	Students create and/or gather pieces of information to form a novel thought, idea, product, or perspective	<ul style="list-style-type: none"> • appraise • choose • compare • consider • criticize • critique • debate • decide • discuss • editorialize • evaluate • give opinion, viewpoint • judge prioritize • recommend • relate • summarize • support • weigh 	<ul style="list-style-type: none"> • conclusion • court trial • critique • debate • decision • defense/verdict • discussion • editorial • evaluation • group discussion • group • letter • news item • panel • rating/grades • recommendation • self-evaluation • standard compared • standard established • survey • valuing

Adapted from the *Nebraska K-12 Foreign Language Frameworks*

STRATEGIES FOR STUDENTS WITH DIVERSE TALENTS
INTERNATIONAL LANGUAGES AND BLOOM'S TAXONOMY

Knowledge/ Comprehension	Application	Analysis	Synthesis	Evaluation
<p><i>What students will do:</i></p> <ul style="list-style-type: none"> • Write telegrams • Arrange lines of dialogues • Fill out authentic forms for the target country • Explain proverbs, slang • Listen for sequence • Explain the "What? Who? Where? How? Why?" • Give description of scenes from a video presentation • Describe pictures from the target country • Define words • Listen and paraphrase in English a conversation heard in the target language • Draw picture from verbal information of a target culture's scene or object 	<p><i>What students will do:</i></p> <ul style="list-style-type: none"> • Dub cartoons, TV shows • Command others step-by-step to prepare a typical cultural dish • Produce questions with correct pronunciation • Apply a cultural custom to a real-life situation in the target country • Interview classmates on their daily activities • Plan a menu for occasions typical of the target culture • Make shopping lists for various cultural, social events • Apply rules of correct cultural protocol while dining in the target country • Classify words, poems, authentic materials, genre • Apply gestures learned to an authentic situation • Apply reading strategies to understand authentic texts 	<p><i>What students will do:</i></p> <ul style="list-style-type: none"> • Identify elements of a particular literary form • Analyze the lyrics of popular songs to compare both cultures' perspectives • Compare points of view found in two editorials • Analyze a story, poem, and other authentic materials • Analyze a scene in the target culture • Find evidence to support opinion • Compare students' customs with the target culture's • Conduct a survey and analyze the results • Analyze the typical foods of the target country for nutritional value • Identify the best route to a historic site in the target country • Play the role of a tourist who bargains for merchandise in the target country 	<p><i>What students will do:</i></p> <ul style="list-style-type: none"> • Write an alternative ending to a story • Predict consequences if other historical events would have resulted differently • Write titles for a play, story, or article • Write headlines in newspaper style on current issues in the target country • Predict future events • Write a diary of an imaginary trip • Extend a story • Hypothesize the reaction to different situations based on the cultural beliefs • Compose a poem, skit, role play, advertisement • Create hypothetical real-world situations found in the target culture • Create an infomercial 	<p><i>What students will do:</i></p> <ul style="list-style-type: none"> • Prioritize solutions to cultural dilemmas • Express and justify opinions on creative products of the culture • Give and support opinions about issues • Evaluate TV shows, movies, cartoons • Write an editorial giving and supporting own opinion • Express the pros and cons of policies • Give and support the decision in a mock trial • Write an ambassador with suggestions for the resolution of a real-world problem • Justify decisions of sites to visit in the target culture • Read an editorial in a target-country newspaper; respond and send response • Evaluate best World Wide Web pages for source of current events in the target country

Adapted from the *Nebraska K-12 Foreign Language Frameworks*

STRATEGIES FOR EXCEPTIONALLY ABLE (GIFTED) STUDENTS

To ensure success *with exceptionally able students* ...

- ◆ allow for choice within assignments and projects.
- ◆ use compacting.
- ◆ allow students to make independent plans for independent learning.
- ◆ provide mentoring or apprenticeship with professionals.
- ◆ teach entrepreneurship.
- ◆ use theory of multiple intelligences.
- ◆ use tiered assignments which are more complex or abstract.
- ◆ use Socratic questioning.
- ◆ use critical and creative questioning strategies.
- ◆ use open-ended questioning strategies.
- ◆ use interdisciplinary units.
- ◆ allow in-depth enrichment learning.
- ◆ allow time with like-intellectual peers.
- ◆ use accelerated pace of instruction.
- ◆ allow dual enrollment or early admission opportunities.
- ◆ remove time and space restrictions to allow for a long-term integrated plan of study.
- ◆ provide more difficult or abstract resources.
- ◆ allow for concrete or real-life investigations and explorations.
- ◆ teach coping skills.
- ◆ allow students to suggest modifications in the content of their learning, the process which they use to learn, and the product they produce to show their learning.
- ◆ clearly communicate criteria and parameters to avoid students taking unacceptable risks or creative detours.

Adapted from the *Nebraska K-12 Foreign Language Frameworks*

STRATEGIES FOR STUDENTS WITH SPECIFIC LEARNING NEEDS
CONSIDERATIONS FOR MEETING SPECIFIC LEARNING NEEDS
IN SKILL AND INSTRUCTIONAL AREAS

To ensure success *with speaking* ...

- | | | |
|---|--|--|
| ◆ give sentence starters. | ◆ use cues and prompts to help the student know when to speak. | ◆ use choral reading or speaking. |
| ◆ use graphic organizers to organize ideas and relationships. | ◆ use partners. | ◆ use rhythm or music. |
| ◆ use visuals. | ◆ phrase questions with choices embedded in them. | ◆ allow practice opportunities for speaking. |
| ◆ allow extra response time for processing. | | ◆ practice role-playing activities. |

To ensure success *with assessment* ...

- | | | |
|---|--|---|
| ◆ use a variety of authentic assessments. | ◆ allow adequate time for test taking. | ◆ give choices. |
| ◆ establish criteria and expectations prior to instruction. | ◆ allow paper-and-pencil tests to be taken in a different space. | ◆ assess learning continuously over time, not just at the end of a unit of study. |
| ◆ teach test-taking strategies. | ◆ allow a variety of ways to respond (e.g., orally, pictorially, tape recordings). | ◆ use rubrics. |
| ◆ teach the format of an upcoming test. | | ◆ use self-assessment tools. |

To ensure success *when working in groups* ...

- | | | |
|--|--|---|
| ◆ teach group rules and expectations. | ◆ post rules and expectations. | ◆ teach a signal for getting attention of all groups. |
| ◆ teach skills of independence (e.g., bridging phrases, disagreeing agreeably, voice level). | ◆ give adequate time but not "fooling around" time. | ◆ practice and assess students' behaviors in small-group settings. |
| ◆ teach manageable strategies for moving in and out of groups within the classroom setting. | ◆ be in close proximity to groups as they work. | ◆ use cooperative learning strategies. |
| | ◆ teach students to self-monitor group progress. | ◆ use a wide variety of groupings (e.g., flexible, cluster, skill). |
| | ◆ assign student roles or responsibilities in the group. | |

Adapted from the *Nebraska K-12 Foreign Language Frameworks*

STRATEGIES FOR STUDENTS WITH SPECIFIC LEARNING NEEDS (CONTINUED)
 CONSIDERATIONS FOR MEETING SPECIFIC LEARNING NEEDS
 IN SKILL AND INSTRUCTIONAL AREAS

To ensure success *with reading* ...

- | | | |
|--|---|--|
| <ul style="list-style-type: none"> ◆ use pre-reading and post-reading activities to pre-teach or reinforce main ideas. ◆ use before, during, and after reading strategies (e.g., before—preview questions; during—pausing to reflect; after—self-evaluation, summary). ◆ provide advanced organizers when showing videos. ◆ use peer tutoring. ◆ provide audiotaped materials (text or study guides). | <ul style="list-style-type: none"> ◆ teach self-questioning. ◆ paraphrase key points and/or have students paraphrase key points. ◆ summarize key points and/or have students summarize key points. ◆ label main ideas. ◆ label 5Ws—Who? What? When? Where? Why? ◆ allow highlighting of texts, passages, key words, or concepts. ◆ use visual imagery. | <ul style="list-style-type: none"> ◆ explain idioms that appear in reading passages. ◆ allow silent pre-reading. ◆ allow partner reading. ◆ use computer programs or games. ◆ allow students to quietly read aloud (subvocalization). ◆ use graphic organizers. ◆ use preparatory set (i.e., talk through what a reading passage is about using new vocabulary and concepts). |
|--|---|--|

To ensure success *with writing* ...

- | | | |
|---|--|--|
| <ul style="list-style-type: none"> ◆ shorten writing assignments. ◆ require lists instead of sentences. ◆ dictate ideas to peers. ◆ provide note takers. ◆ allow students to use a tape recorder to dictate writing. ◆ allow visual representation of ideas. ◆ provide a fill-in-the-blank form for note taking. ◆ allow students to use a computer for outlining, wordprocessing, spelling, and grammar check. | <ul style="list-style-type: none"> ◆ provide a structure for the writing. ◆ allow collaborative writing. ◆ provide a model of the writing. ◆ allow use of different writing utensils and paper. ◆ use a flow chart for writing ideas before the student writes. ◆ brainstorm a word bank of possible words that would be needed prior to the writing activity. | <ul style="list-style-type: none"> ◆ narrow the choice of topics. ◆ grade on the basis of content; do not penalize for errors in mechanics and grammar. ◆ allow choices of manuscript, cursive, keyboarding. ◆ allow different positions of writing paper and/or surfaces. |
|---|--|--|

Adapted from the *Nebraska K-12 Foreign Language Frameworks*

STRATEGIES FOR STUDENTS WITH SPECIFIC LEARNING NEEDS (CONTINUED)
CONSIDERATIONS FOR MEETING SPECIFIC LEARNING NEEDS
IN SKILL AND INSTRUCTIONAL AREAS

To ensure success *with visually-impaired learners* ...

- ◆ describe what you are doing.
- ◆ provide preferential seating.
- ◆ provide material in large or braille print.
- ◆ give student an individual copy of visual information presented to the group.
- ◆ use black-and-white printed hand outs.
- ◆ use audiotaped books.
- ◆ use tactual materials to represent concepts—contact a vision consultant to assist with the design.
- ◆ be aware of lighting requirements.
- ◆ stand away from window glare when talking to the student.
- ◆ allow extra time to complete a task.

To ensure success *with hearing-impaired learners* ...

- ◆ provide preferential seating.
- ◆ use visual cues (overheads, drawings maps, demonstrations, visual samples of new vocabulary).
- ◆ face student directly when speaking.
- ◆ emphasize key points; don't overload with information.
- ◆ repeat or rephrase what other students say—hearing what other students say is often difficult for hearing-impaired students.
- ◆ highlight text and study guides.
- ◆ provide note-taking assistance during lectures to allow hearing-impaired student to concentrate on the teacher.
- ◆ use peer tutoring.
- ◆ use study sheets to organize information.
- ◆ pre-teach vocabulary.
- ◆ use captioned videos, films, etc.
- ◆ show videos or visuals before presenting information to provide a knowledge base for students.
- ◆ use alternative testing methods.
- ◆ minimize background noise.
- ◆ simplify vocabulary.
- ◆ use preprinted outline of materials.

To ensure success *when working in groups* ...

- ◆ use multi-modalities (visual, auditory, tactile) to teach the same concept.
- ◆ teach vocabulary in context.
- ◆ use cues, prompts.
- ◆ use graphic organizers.
- ◆ use frequent repetition of key points.
- ◆ break down instructional units into smaller steps.
- ◆ show relationships among concepts through graphs, outlines, and webbing.
- ◆ use color coding to show concepts and relationships.
- ◆ use peer tutors.
- ◆ highlight important information.
- ◆ teach mnemonics as a memory tool.
- ◆ teach visual imagery.
- ◆ use rhythm, music, and movement.
- ◆ use lists.
- ◆ use matrix to organize information; allow students to construct some of their own.
- ◆ use pictographs

Adapted from the *Nebraska K-12 Foreign Language Frameworks*

STRATEGIES FOR STUDENTS WITH SPECIFIC LEARNING NEEDS (CONTINUED)

CONSIDERATIONS FOR MEETING SPECIFIC LEARNING NEEDS

IN SKILL AND INSTRUCTIONAL AREAS

To ensure success *with understanding new concepts* ...

- ◆ pre-teach new concepts.
- ◆ identify priority learning from less important material.
- ◆ provide adequate time.
- ◆ provide meaningful practice, review, repetition.
- ◆ use flow charts.
- ◆ connect previous learning to new information.
- ◆ use multiple means of learning the same material (visual, auditory, tactile).
- ◆ have student set personal goals.
- ◆ use peer tutors.
- ◆ use multiple intelligences information to deliver material in a variety of ways.
- ◆ use cooperative learning and small groups.
- ◆ provide cues.

Adapted from the *Nebraska K-12 Foreign Language Frameworks*

To ensure success *with attention deficit learners* ...

- ◆ surround students with peers who are good role models. Encourage peer tutoring and cooperative, collaborative learning.
- ◆ maintain eye contact with students during verbal instruction.
- ◆ make directions clear and concise. Be consistent with daily instructions.
- ◆ simplify complex directions. Avoid multiple commands.
- ◆ make sure that students comprehend before beginning the task.
- ◆ repeat in a calm, positive manner, if needed.
- ◆ help students to feel more comfortable seeking assistance. (Most ADD students won't ask for help.)
- ◆ assign only one task at a time.
- ◆ monitor frequently. Use a supportive attitude.
- ◆ modify assignments as needed. Special education personnel can identify specific strengths and weaknesses of students.
- ◆ make sure you test knowledge and not attention span.
- ◆ give extra time for certain tasks. Students with ADD may work more slowly. Don't penalize for needed extra time.
- ◆ require a daily assignment notebook if necessary. Make sure students write down all assignments each day. Parents and teachers may sign the notebook on a daily basis and use this as an additional form of communication with one another.

Adapted from the list compiled by members of CH.A.D.D. (Children with Attention Deficit Disorders) in *Meeting The Special Needs of Students*. Mission Hills, CA: Glencoe/McGraw-Hill 1997, p. 10.

Developing Intercultural Competence

Intercultural competence is a combination of knowledge, skills, and attitudes which enable individuals to communicate and interact across cultural boundaries. In the Spanish Language and Culture program, these include the skills of finding information about Spanish-speaking cultures, interpreting it in order to understand the beliefs, traditions, and cultural values of Hispanic people, relating one's own culture to cultures of Spanish-speaking peoples, and interacting with members of these cultures. In the process of developing these skills, language learners will acquire knowledge of various aspects of these cultures, a heightened awareness of their own, as well as knowledge of the processes of interaction between the two cultures. They will also work towards an attitude of increased openness, curiosity, and willingness to look at the world from the point of view of others.

Culture in this program is broadly defined as the general context and way of life, the behaviours and beliefs of a community of people whose history, geography, institutions, and commonalities are distinct and distinguish them to a greater or lesser degree from all other groups (Leblanc 44). The historical and contemporary elements of the culture from which the content is drawn may include

- historical and contemporary events
- significant individuals
- emblems or markers of national identity such as myths, cultural products, significant sites, and events in the collective memory
- public institutions
- geographical space (regions, landmarks, borders, climate)
- social distinctions
- conventions of behaviour
- beliefs, taboos, perceptions, and perspectives

Choices about which elements to include should reflect the importance of the element within the culture, and the interests and developmental level of the students.

Although cultures exert pressure on their members to conform to a variety of norms, most cultures are not homogeneous. Within each one, there are groups of people who have beliefs, values, and practices that are different from the majority or mainstream culture. These differences may be based on religion, national or ethnic origin, social class, race, or colour. A number of outcomes in this program are aimed at making students aware of the diversity within a particular culture in the Spanish-speaking world as well as differences between them and Canadian cultures.

The development of intercultural competence can take place in three contexts: in the classroom, as fieldwork, or as an independent experience. In the **classroom**, activities are planned and structured by the teacher and usually take the form of a rehearsal for interaction in real time. In the classroom, students have the opportunity for discovery and analysis of the culture along with reflection on their learning without the pressure of real time. In other words, they do not have to respond immediately. In **fieldwork**, activities are still planned and structured, but the interaction is now in real time. **Independent experiences** are those carried out by students outside of the structure of the course. This curriculum guide will deal principally with classroom activities, but with some comments on fieldwork.

Resources

Finding resources for students at a beginner level of second language learning is a challenge. Authentic documents, in other words, documents created for native speakers of Spanish and not for language learning, are useful in that they provide students with actual contact with the culture. However, finding authentic documents in which the language is appropriate for beginners can be difficult. Documents that have a high level of visual support (pictures, charts, maps, etc.) and a minimum of text are the easiest to use. Students can be taught interpretation strategies for dealing with so-called “difficult” texts. See the Sample List of Text Forms in Appendix B for ideas on the kinds of documents to look for.

Other kinds of resources are also useful for different kinds of activities. Outdated textbooks with stereotyped representations of the culture, for example, can be used to make students aware of such stereotypes. Resources can also take the form of cultural artifacts (costumes, food, music, everyday objects, crafts, etc.). These materials, which are concrete and appeal to the physical senses, are especially useful for younger students as a bridge to more abstract ideas. The greater the variety of resources, the more the students will become aware that culture is expressed through various forms, not just classical literature and fine arts.

Discovery

Students at the middle level may be very diverse in their level of cognitive and affective development. Some may be ready to handle abstract concepts such as “culture” while others are not. Some may be able to take another’s perspective, while others may be very ethnocentric in their attitudes. For this reason, initial experiences should be concrete and should involve as many of the physical senses as possible.

Interpretation

As students begin to use authentic texts, they will need to be taught skills for delving beyond the literal meaning.

Relating

“Whenever we encounter the unknown we attempt to understand it in terms which are part of our familiar world and our understanding of it. [...] Comparison therefore needs to be part of the teacher’s explicit methods...” (Byram and Zarate). By exposing students to experiences of other modes of behaviour, either in the form of real-life experiences (e.g., food) or through media (e.g., television programs), and then having them compare these experiences with their own modes of behaviour, they will begin to understand that their own way is not the only way, but just one of many ways that are influenced by culture. If students in the class are from a variety of cultural backgrounds, this understanding will be reinforced even more.

Reflection

Personal experience of elements of another culture is not, in itself, enough to counteract the tendency to reject that which is different. It is through a process of reflection and discussion following the experience that students can become aware of the process of socialization, of the natural tendency to stereotype, to reject that which is different and to see it as a threat to one’s identity. In early stages of learning, this discussion may take place in English until students have the vocabulary and structures to begin to express their feelings and thoughts in Spanish.

The experience of contact with a new cultures, reflection on that experience, and the varied responses of other students in the class who may be from different cultural backgrounds can take students one step further than just knowledge of that culture. Ideally they will come to understand the concept of culture and the phenomena (e.g., ethnocentrism, empathy, stereotyping, exoticism, discrimination, culture shock) that are characteristic of the relationship with other cultures.

Integration with Other Subjects

Intercultural competence can be developed in courses other than second language courses. Social studies and language arts are the subject areas where integration is most easily achieved. A process of collaborative planning between the Spanish teacher and the social studies or language arts teachers can be fruitful for both. In addition, students benefit from seeing the links between areas of study, transferring knowledge from one domain to another, and making connections that might otherwise have gone unnoticed.

The collaborative planning can take a variety of forms, from simply keeping each other informed of units of study that might provide opportunities for reinforcement of learning, to actually planning units together.

A Model for Spanish Language and Culture Courses at the Secondary Level

As the preceding discussion demonstrates, there are many factors and aspects of teaching and learning that must be considered in developing an effective instructional program and classroom. We can conceptualize this as being the interplay of six factors: learner, teacher, course content, learning environment, pedagogy, and assessment.

A MODEL FOR EFFECTIVE TEACHING AND LEARNING
(SECONDARY LEVEL)



Adapted from *New Jersey World Languages Curriculum Framework*, Winter 1999

Teaching and Learning in the Spanish Classroom

Instructional Strategies

Effective teachers know they are teaching students as well as content. They also know that, in every class, there will be a diversity of students, each of whom will bring to the activity environment different perceptions, prior knowledge, attitudes, and learning styles. It is the teacher's responsibility to make use of a variety of instructional approaches to ensure that all types of students and their various needs are being met.

Decision-making regarding instructional strategies requires teachers to focus on curriculum, the prior experiences and knowledge of students, learner interests, student learning styles, and the developmental levels of the learner. Such decision-making relies on ongoing student assessment that is linked to learning objectives and processes.

The following diagram shows the five instructional strategies that are most effective in developing communicative competence in second language classrooms. They have been grouped according to the categories outlined in *Instructional Approaches: A Framework for Professional Practice* (Saskatchewan Education, available online at <<http://www.sasked.gov.sk.ca/docs/policy/approach/index.html>>). A more detailed description of some of these strategies follows.

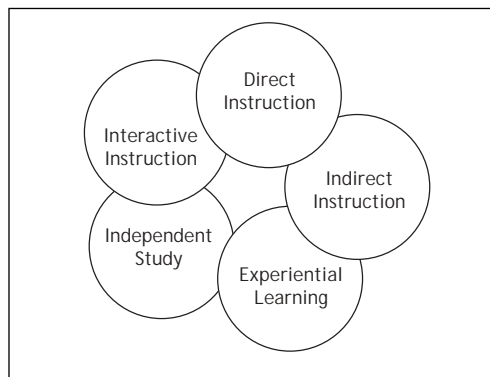

Figure 3. Instructional Strategies

Direct Instruction

Direct instruction is highly teacher-directed and is historically one of the strategies most commonly used. It is used for providing information or developing step-by-step skills. This strategy works well for introducing other teaching methods or actively involving students in knowledge construction.

Direct instruction is usually deductive; that is, the rule or generalization is presented and then illustrated with examples. While this strategy may be considered easy to use, effective direct instruction is often more complex than it would first appear.

Indirect Instruction

Indirect instruction is mainly student-centered and seeks a high level of student involvement in observing, investigating, drawing inferences from data, or forming hypotheses. It takes advantage of students' interest and curiosity, often encouraging them to generate alternatives or solve problems. It is flexible, in that it frees students to explore diverse possibilities and reduces the fear associated with the possibility of giving incorrect answers. Indirect instruction also fosters creativity and the development of interpersonal skills and abilities.

Interactive Instruction

Interactive instruction relies heavily on discussion and sharing among participants. Discussion and sharing provide learners with opportunities to "react to the ideas, experience, insights, and knowledge of the teacher or of peer learners and to generate alternative ways of thinking and feeling" (Seaman and Fellenz 119). Students can learn from peers and teachers to develop social skills and abilities, to organize their thoughts, and to develop rational arguments. The interactive instruction strategy allows for a range of groupings and interactive methods.

Experiential Learning

Experiential learning is inductive, learner-centred, and activity-oriented. Personalized reflection about an experience and the formulation of plans to apply learning to other contexts are critical factors in effective experiential learning. The emphasis in experiential learning is on the process of learning, and not on the product. Experiential learning occurs when learners

- participate in an activity and critically look back on the activity to clarify learning and feelings
- draw useful insights from such analysis and put learning to work in new situations

Independent Study

Independent study refers to the range of instructional methods which are purposefully provided to foster the development of individual student initiative, self-reliance, and self-improvement. While independent study may be initiated by student or teacher, the focus here will be on planned independent study by students under the guidance or supervision of a classroom teacher.

In addition, independent study can include learning in partnership with another individual or as part of a small group. Independent study encourages students to take responsibility for planning and pacing their own learning.

After deciding on appropriate instructional strategies, a teacher must make decisions regarding instructional methods. As is the case with strategies, the distinctions between methods are not always clear-cut, although they are categorized for the purpose of this document. The following checklist illustrates how various methods relate to the five broad categories of strategies. It should be noted that the methods appearing in the checklist are examples only, and are not intended to be inclusive of all instructional methods.

Instructional Methods Checklist

Direct Instruction

- Compare and Contrast
- Demonstration
- Didactic Questions
- Drill and Practice
- Guides for Listening, Reading, and Viewing
- Mini-lecture
- Password/Language Ladders
- Read and Retell
- Structural Exercises

Indirect Instruction

- Author's Chair
- Case Studies
- Cloze Procedure
- Graphic Organizers
- Discussions
- Grammatical Problem Solving
- Reflective Discussions

Interactive Instruction

- Brainstorming
- Categorizing
- Circle of Knowledge
- Cooperative Learning
- Cultural Presentations
- Information Gap
- Interactive Language Tasks
- Language Experience
- Learning Cycle
- Surveys and Interviews
- Debate
- Problem Solving

Experiential Learning

- Field Trips
- Focused Imaging
- Games
- Role Play

Independent Study

- Computer-Assisted Instruction
- Logs and Journals
- Free Writing
- Personal Dictionaries
- Learning Contracts
- Research Projects

Direct Instruction Methods

Direct instruction methods are highly teacher-centered. They are often used in the following situations:

- daily, weekly, and monthly review
- presenting new material
- conducting guided practice
- providing feedback and correctives

Compare and Contrast

This method involves looking for similarities and differences, for example, between an aspect of a Spanish-speaking culture and the students' own culture.

Students

- observe details and develop criteria
- identify similarities
- search and sort out differences based on criteria
- summarize

The four components of compare and contrast, as listed above, can be used in assessment as criteria in the templates for anecdotal records, checklists, and rating scales.

Demonstration

This method refers to teacher activities and talk that show students how. Demonstrations apply primarily to skills and processes, and are useful for helping students acquire procedural knowledge. Teachers might, for example, take students step by step through the writing process, or demonstrate a particular learning strategy.

Didactic Questions

These are questions that tend to be convergent (they tend to focus on one topic) and factual. They often begin with " *qué*," " *dónde*," " *cuándo*," " *adónde*," or " *cómo*."

The teacher is able to observe the degree of student acquisition of knowledge of content and process through this activity. A written assignment or an oral presentation or interview (live or taped) may be the ongoing student activity used for assessment. The teacher will record student progress using a rating scale, checklist, or anecdotal records.

Drill and Practice

This method refers to the structured, repetitive review of previously learned concepts to a predetermined level of mastery. It tends to focus on skills. Care should be taken to ensure that these exercises are directly related to the context in which the student will use the language being practised and that they require the student to focus on the meaning as well as on the form. To assess the level of skill, teachers will need to use performance assessments or performance tests. Teachers need to establish criteria indicating what students are to do. The criteria are inserted into the templates for anecdotal records, rating scales, and checklists.

Guides for Listening, Reading, and Viewing

Students' comprehension of a selection is guided and developed by teacher-prepared questions or graphic organizers. As students gain practice and confidence in using this method, the teacher will monitor or confer with small groups or individuals.

Mini-lecture

The mini-lecture is a one-way type of communication. It is an efficient way of providing a small amount of information in a short period of time. The purpose of a mini-lecture is to impart knowledge about an aspect of culture, for example, or a grammatical structure.

Mini-lectures are effective when they are

- 10–15 minutes in duration, and never longer than 20 minutes
- mixed with group discussion and demonstrations
- accomplished with such visual aids as overhead transparencies and posters.

The most appropriate way of assessing understanding is a combination of test items such as essay, short-answer, multiple-choice, and true/false.

Password/Language Ladders

This is a method in which students learn to speak sentences or phrases ("passwords") that are associated with desired activities.

The teacher introduces a series of phrases in Spanish that the students must speak in order to do a desired activity, such as "*¿Puedo ir al baño?*" "*¿Puedo sacarle punta a mi lápiz?*" "*¿Puede ayudarme?*" The students learn new passwords of increasing complexity in subsequent classes.

Password/language ladders are effective when they

- engage students' active participation
- give an authentic experience of using Spanish
- develop oral comprehension as a continuum within authentic situations

Read and Retell

This all-purpose method involves students retelling a passage in Spanish as they remember it.

The teacher asks the students to read a passage. Students can be working together as a class, in small groups, in pairs, or working alone with the teacher. Then, the teacher asks the students to retell the passage as they remember it, either orally or in writing using Spanish.

Read and retell is effective when it

- provides practice in a range of literacy skills in the target language including listening, speaking, reading, writing, interacting, comparing, matching, selecting, remembering, comprehending, and organizing the information
- provides an index of growth and development in a wide range of literacy learning
- provides opportunities to use the target language

Structural Exercises

Definition

Structural exercises are exercises that focus the attention of the students on the form or structure of the language. Research has shown that students learn better from these kinds of exercises if there is a direct connection with their own productions. Structural exercises can take a variety of forms depending on the structures and vocabulary that need to be practiced. Some examples are

- adding words or phrases to a short sentence
- taking words or phrases out of a long sentence
- substituting words or phrases for other ones in a sentence
- moving words or phrases around in a sentence
- changing elements of a sentence.

Procedure

The basic procedure is similar for all types of exercises.

1. Begin with sentences taken from texts written by the students. Choose structures that are giving problems to a number of students.
2. Write the sentences on strips of paper and cut them up. When doing this for the first time with students, write on large strips so that the whole class can see what you are doing. Later, when students are able to do these exercises on their own or in small groups, the sentences can be written on smaller strips of paper. Have some blank strips of paper ready for new words.

3. Ask students for suggestions depending on the type of exercise you have chosen (add, take away, substitute, move, change, etc.). Analyze the new sentence that is formed, by asking questions such as, "Does this new sentence make sense?", "How has the meaning changed?", "Do we have to make any other changes so that the sentence is still grammatically correct?"
4. Repeat these steps a number of times as a whole group, then have students do more individually or in small groups.
5. Students should have opportunities to use the same structures and vocabulary in their own speech or writing as soon as possible after doing the exercises.

Tips

The analysis and discussion that follow each change in the sentence is particularly important to make students aware of changes in the meaning. Exercises where students make changes to sentences without having to reflect on the meaning are not effective in teaching and reinforcing structures.

In some cases structural exercises can be based on or can be transformed into songs or cumulative stories (stories in which a part of the story is repeated with a new element added on each time).

Applications

1. Add a word or phrase. Use this exercise to encourage students to expand their vocabulary, to provide more detail and to use more complex sentence structures. An example follows:

Aquí está mi casa.

Aquí está mi casa pequeña.

Aquí está mi casa pequeña y blanca.

Aquí está mi casa pequeña y blanca de ladrillo.

2. Take away a word or phrase. This exercise helps students understand which elements are necessary for the syntax of the sentence. An example follows:

Las/os niñitos aprenden poemas infantiles de su madre.

Las/os niños aprenden poemas infantiles de su madre.

Los niños aprenden poemas infantiles de su madre.

Los niños aprenden rimas de su madre.

Los niños aprenden rimas.

3. Substitute one word or phrase for another in the sentence. This form of exercise helps students understand which elements in the sentence perform the same function. The following exercise focuses attention on the possessive pronouns as per the following chart.

Singular	Plural	Singular	Plural
<i>el mío la mía</i>	<i>los míos las mías</i>	<i>el nuestro la nuestra</i>	<i>los nuestros las nuestras</i>
<i>el tuyo la tuya</i>	<i>los tuyos las tuyas</i>	<i>el vuestro la vuestra</i>	<i>los vuestros las vuestras</i>
<i>el suyo la suya</i>	<i>los suyos las suyas</i>	<i>el suyo la suya</i>	<i>los suyos las suyas</i>

Este es tu coche/carro.

Este es el tuyo.

Este es nuestro coche/carro.

Este es el nuestro.

Aquí está la tarea.

Aquí está la mía.

Aquí están sus deberes.

Aquí están los suyos.

4. Move a word or phrase to another place in the sentence. Moving elements around in the sentence encourages students to use a variety of different sentence structures and to recognize the limits imposed by normal word order. It also sensitizes students to subtle changes in meaning communicated by changes in word order. An example follows:

Rápidamente cruzó la calle corriendo.

Ella cruzó la calle rápidamente corriendo.

Ella cruzó la calle corriendo rápidamente.

Students may find another way of changing the sentence.

5. Change an element of the sentence. Once again, this type of exercise encourages students to vary their sentence structure and to practise different sentence types. Examples follow:

Me gustan los perros calientes. → No me gustan los perritos calientes.

Use the same words to present different ways to structure language:

noun — pronoun

statement to question

Isabel va a la escuela. → ¿Va Isabel a la escuela?

Language Development

Specific exercises can be devised to work on the most common errors that students make. For example, take sentences from the rough drafts of student writings, do appropriate structural exercises, and then have students correct their own productions. The repetition involved in doing the exercises helps to make common structures automatic for second language students.

Indirect Instruction Methods

Indirect instructional methods are student-centered. These methods are very effective when the instructional goals include

- thinking outcomes
- attitudes, values, or interpersonal outcomes
- process as well as product
- personalized understanding and long-term retention of concepts or generalizations
- lifelong learning capability

Author's Chair

During this procedure, students read aloud their written drafts or compositions to others. Listeners provide positive comments and constructive feedback to the "author" to assist future writing efforts. Writing is usually shared with the entire class, but occasionally authors could read to small groups. One particular chair or area of the classroom may be designated for this activity.

Case Studies

Case studies are usually descriptions of real or imaginary situations that are either unresolved or have a controversial theme. They are used for group discussion and for the generation of ideas and solutions. Case studies are a useful strategy for looking at misunderstandings between people of different cultural groups. They can be used as individual assignments or as small group assignments. Discussion of what has been learned is a valuable follow-up to a case study approach.

Cloze Procedure

The Cloze Procedure is an open-ended method in which a selected word or phrase is eliminated from a written or oral sentence or paragraph.

The teacher eliminates a word or phrase from the sentence. Students complete the sentence with a word that “makes sense.” The teacher may select random words or a specific part of speech. This can be expanded to the more difficult task of finding a word that makes sense when only the initial letter of the word is provided.

Cloze is effective when it

- provides opportunities for creativity
- develops the use of precise vocabulary
- focuses on the use of precise and correct communication
- increases comprehension skills
- provides opportunities to use Spanish

Procedure

The cloze procedure is most often used with written texts and is particularly effective if done with groups of students rather than individually.

1. Choose a written text (or write a text) appropriate to the students' level. Leave the first sentence untouched, then delete a number of words from the rest of the text, leaving the last sentence untouched as well. There are a number of ways of deciding which words to delete:
 - delete every seventh word (fewer for beginner level students, more for more advanced students)
 - delete key words related to the topic of the sentence
 - delete words that have a particular grammatical function (such as all the adjectives, or all the pronouns).

Replace the words with blanks of equal length so that there is no clue as to the length of the words that have been deleted.

2. Ask the students to read the text and try to fill in the missing words. They can use any clues they can find in the text, or any knowledge they have of the topic or the language to try to discover what the missing words might be. The text must make sense when it is complete.
3. Ask the students to explain why they think a particular word fits the blank in the sentence. If there is more than one suggestion, the students can discuss their reasons for each choice and decide which is the best. The sharing of ideas and interpretation strategies is an important aspect of this instructional method.

Tips

If the students have never done this kind of exercise before, do several together with the whole class before having them work independently in small groups. Model the process of looking for clues in the text by “thinking aloud” as you go through the text with the students.

The object of the activity is not necessarily to find the original word. If the students are able to fill the blank with a word that makes sense and fits the sentence grammatically, it does not need to be the word originally in the text.

Make a list of the strategies used to fill in the missing words and post it in the classroom. Add to the list as new strategies are introduced.

Applications

The cloze procedure can be used on the opening paragraphs of a longer text that the students will be reading to help them focus on key words for the reading and to encourage them to use their background knowledge of the topic to improve comprehension.

This procedure can also be used orally to encourage students to predict what is to come. While reading aloud, stop and have students listen carefully to predict the next word or phrase in the sentence.

The cloze procedure can also be employed to assess the students’ use of a variety of interpretation strategies and their awareness of particular language patterns and structures.

Language Development

The cloze technique helps students become aware of interpretation strategies they are using and learn new strategies by listening to the explanations of their fellow classmates. It helps them learn to use the context and their prior knowledge to make intelligent guesses about unknown words they may encounter in their reading.

Graphic Organizers

Definition

Graphic organizers are visual representations of texts or groups of related ideas, words or thoughts. They can take a variety of forms, some of which have a specific name, depending on what they are representing and how they will be used. Some examples are frames, mind maps, webs, concept or semantic maps, story maps, Venn diagrams, and flow charts.

The teacher provides a specific format for learning, recalling, and organizing linguistic or cultural concepts learned through Spanish.

Graphic organizers are beneficial when they are used to

- help students visualize abstract concepts
- help learners organize ideas
- provide a visual format for study

Consequence Diagram/Decision Trees—A graphic organizer method in which students use diagrams or decision trees to illustrate real or possible outcomes of different target cultural actions or situations.

Students visually depict outcomes for a given problem by charting various decisions and their possible consequences.

Consequence diagrams/decision trees are effective tools to

- help in transferring Spanish-language learning to application
- aid in predicting with accuracy
- develop the ability to identify the causes and effects of decisions
- aid in clarifying positive and negative statements

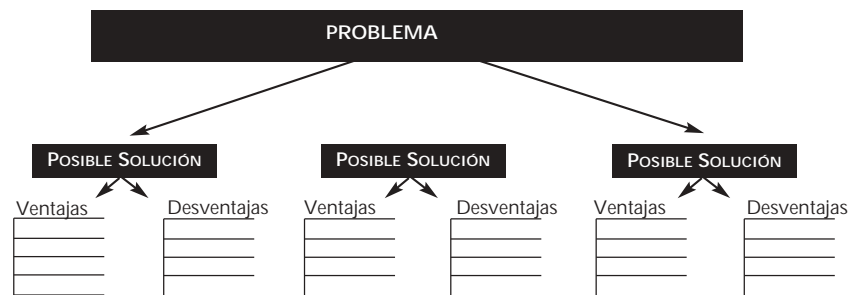

Concept Mapping—A graphic organizer method that shows the relationships among concepts. Usually the concepts are circled and the relationships are shown by connecting lines with short explanations in Spanish or graphical depictions of the objects or concepts.

The teacher selects a main idea. Using Spanish, the teacher and students then identify a set of concepts associated with a main idea. Concepts are ranked in related groups from most general to most specific. Related concepts are connected and the links labeled with words, pictures, or short phrases.

Concept mapping is an effective tool to

- help students visualize how ideas are connected, and understand linguistic relationships and how knowledge is organized
- improve oral communication, comprehension, and problem-solving skills

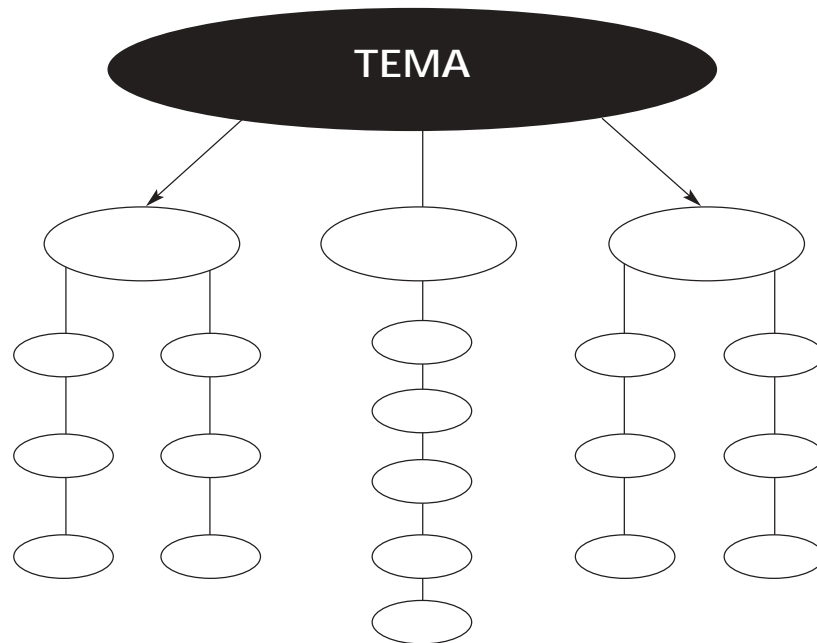

K-W-L (Know-Want to Know-Learned)—An introductory method that provides a structure for recalling what students know regarding a target language or cultural topic, noting what students want to know, and finally listing what has been learned and is yet to be learned.

Before engaging in an activity, reading a chapter, listening to a lecture, or watching a film or presentation, the teacher lists on the board under the heading **What We Know** all the information students know or think they know about a topic. Then, the teacher lists all the information the students want to know about a topic under **What We Want to Know**.

While engaging in the planned activity, the students research and read about the topic, keeping in mind the information they had listed under **What We Want to Know**.

After completing the activity, the students confirm the accuracy of what was listed and identify what they learned, contrasting it with what they wanted to know. The teacher lists what the students learned under **What We Learned**.

K-W-L strategies are effective tools to

- build on prior knowledge
- develop predicting skills
- provide a structure for learning
- develop research skills
- develop communication skills in cooperative groups
- strengthen teamwork skills
- provide opportunities to use Spanish reading, writing, listening, speaking, and viewing

S	Q	A
<i>Lo</i>	<i>Lo que</i>	<i>Lo</i>
<i>que</i>	<i>queremos</i>	<i>que</i>
<i>sabemos</i>	<i>saber</i>	<i>aprendimos</i>

Learning Log—A method to develop structured writing in Spanish. An excellent follow-up to K-W-L.

During different stages of the language learning process, students respond in written form under three columns:

What I Think/Lo que pienso

What I Learned/Lo que aprendí

**How My Thinking Has Changed/
Cómo ha cambiado mi opinión**

Learning logs are effective tools to

- bridge the gap between prior knowledge and new content
- provide a structure for translating target language concepts into written form.

Webbing—A graphic organizer method that provides a visual picture of how target language words or phrases connect to a content-based or cultural topic.

The teacher lists a topic and builds a web-like structure of target language words or phrases that students call out as being connected to a topic. Students can also use this method individually in planning, writing, or in studying for a test.

Webbing is an effective tool to

- provide opportunities for the visual learner to “recall” the connections for later use
- help students use and share their prior linguistic knowledge
- help students identify patterns of information

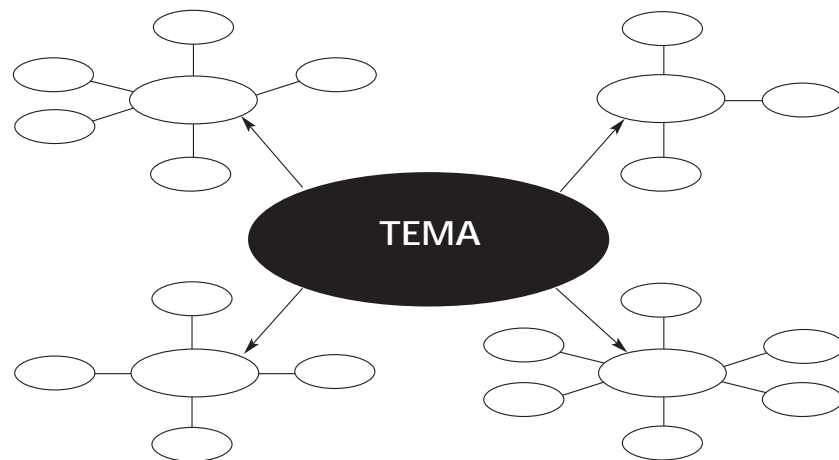

Venn Diagram—A graphic organizer method, derived from mathematics, for creating a visual analysis of information representing the similarities and differences among, for example, Spanish language concepts or Spanish culture objects, events, animals, and people.

Using two overlapping circles, students list unique characteristics of two items or concepts (one in the left part of circle and one in the right); in the middle they list shared characteristics. More than two circles can be used for a more complex process.

Venn Diagrams are effective tools to

- help students organize ideas, and Spanish language and culture concepts
- help students develop a plan for writing
- allow students to focus on the similarities and differences within and among languages and cultures
- develop the ability to draw conclusions and synthesize
- stimulate higher cognitive thinking skills

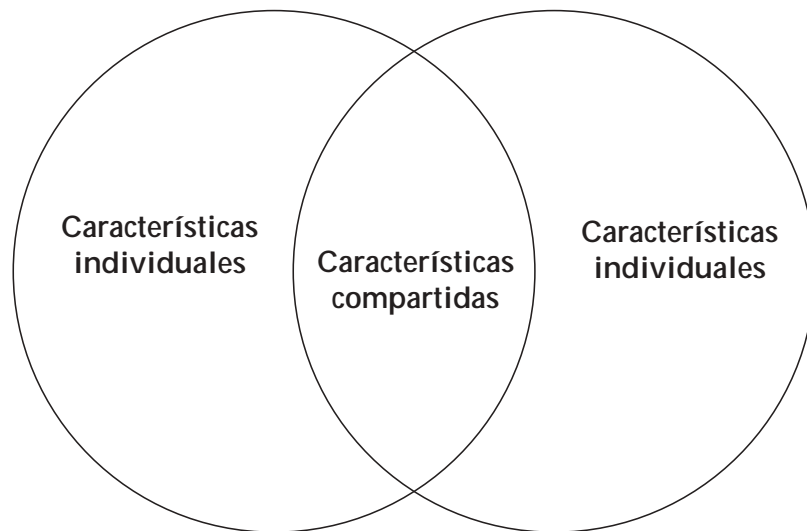

Flowchart—A graphic organizer method used to depict a sequence of events, actions, roles, or decisions.

Students structure a sequential flow of events, actions, roles, or decisions graphically on paper.

Flowcharts are effective tools to

- foster logical and sequential thinking
- focus on cultural connections
- develop the ability to identify details and specific points
- develop organizational skills
- aid in planning
- provide an outline for writing in the target language

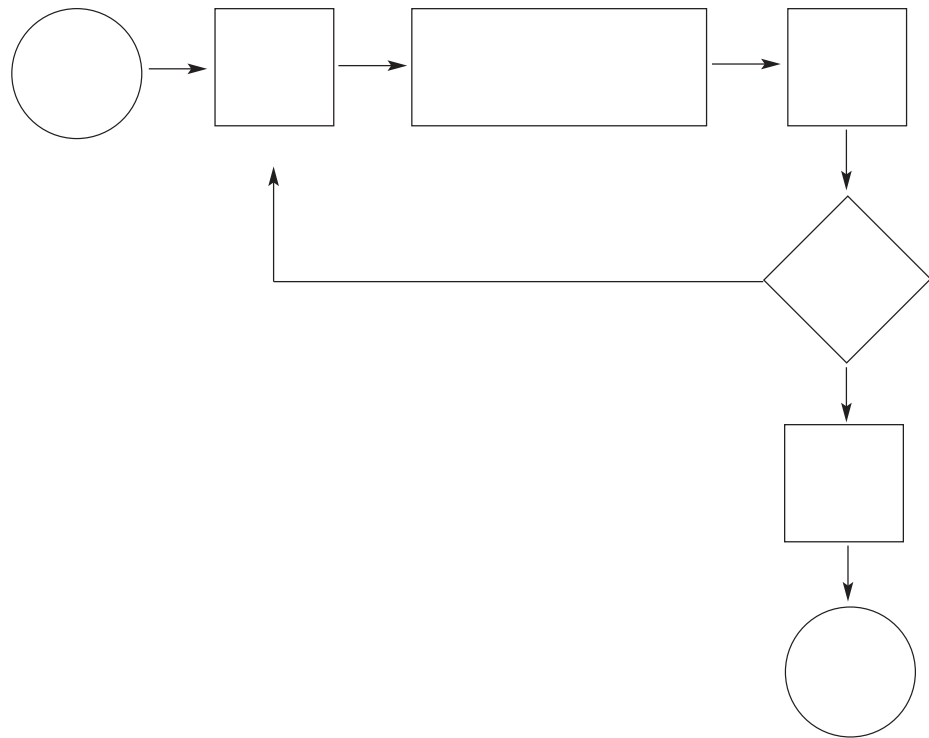

*T-Chart**

Purpose: To clarify central concepts or ideas; to collect specific examples for an idea or behavior.

Thinking Skills: Specifying, categorizing

How to use: In the **Looks Like** column, list all the behaviors or observable characteristics related to a topic; in the **Sounds Like** column, list all the sounds or audible characteristics, including possible verbal messages.

*As described and illustrated in Bellanca

ACUERDO	
<p><i>Looks Like / Se ve como</i></p> <p>nodding head / <i>asentir con la cabeza</i> eye contact / <i>contacto visual</i> smile / <i>sonrisa</i> attention / <i>atención</i></p>	<p><i>Sounds Like / Parece como</i></p> <p>"I can live with it." / <i>"Puedo vivir con ello."</i> "Good idea." / <i>"Buena idea."</i> "That will help us." / <i>"Eso nos ayudará."</i> "I see your point." / <i>"Te entiendo."</i></p>

Name(s) / Nombre(s) _____ Topic / Tema _____	
T-CHART / CUADRO T	
Title / Título _____	
<i>Looks Like / Se ve como</i>	<i>Sounds Like / Parece como</i>

Procedure

When introducing graphic organizers for the first time, model their use in a simple situation, going step by step through the process, explaining what you are doing at each step and why. Use the same graphic organizer on several occasions, getting more and more student input each time. As students gain more understanding and skill, they can be given more opportunity for discussion about how different elements should be represented and what they should be linked to. Once students are accustomed to using a particular type of graphic organizer, they can begin to use it independently in small groups. The form of familiar graphic organizers can be posted in the classroom as a resource for students as they work.

Second language learners may need some preparation before working on a graphic organizer to build their vocabulary on the topic. They might watch a short film, read a text (or listen to someone else read), or brainstorm ideas and categorize them. Throughout the preparatory activity and the development of the graphic organizer, the teacher can supply any vocabulary that the students are lacking.

Tips

For beginners or younger students, pictures can be used instead of, or in addition to, words.

Use different colours and shapes to add more meaning to the graphic organizer. For example, use wool or string of different colours to show links between words or ideas.

Prepare labels of the words associated with a theme or topic and have students organize them, showing the connections they think are important. When they are happy with their arrangement, they can glue the labels on a large sheet of paper or attach them to a bulletin board with tacks or staples.

Applications

People construct knowledge based on what they already know. Graphic organizers are used to organize and represent knowledge, and help the learner construct new meanings in a subject. The goal of this method is not to find the "right answer" or the "correct" graphic organizer. It is to improve understanding of texts or to explore how ideas or words relate to each other.

Understanding can be expanded by discussing different visual representations and seeing how others' interpretation is different from one's own.

The following is a partial **concept map** based on weather which could be used to summarize vocabulary introduced in a unit on that topic or to prepare for a listening activity using weather reports.

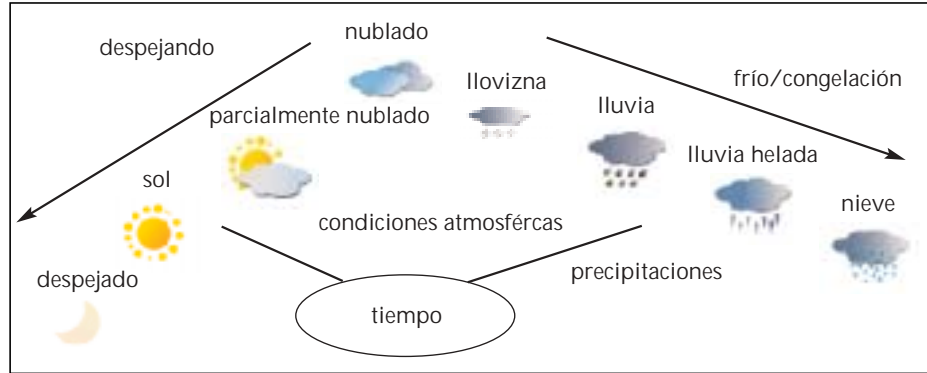

The following graphic organizer is a story map that shows the principal elements that are present in most fiction. Story maps can be used to help students understand the structure of a story, to see common patterns from one story to another, to assess their understanding of a specific story, to make predictions before beginning to read or listen to a story, or as a planning tool when preparing to write a story.

¿Quién? (¿Quiénes son los personajes?) _____

¿Cuándo? (¿Cuándo ocurre la historia?) _____

¿Dónde? (el escenario) _____

Al comienzo/principio (¿Cuál es la situación?)

La parte principal (¿Cuáles son los acontecimientos?)

El fin/la conclusión (¿Cómo termina el cuento/la novela/la historia?)

Different kinds of graphic organizers can be used to represent expository texts. The most common structures for these kinds of texts are

- description
- enumeration or listing
- comparison and contrast
- cause and effect
- problem and solution

At the same time as students are made aware of how these different kinds of texts are organized, they can learn the key words and phrases used to structure the texts. A **Venn diagram** is an example of a graphic organizer for comparison and contrast. Differences are recorded in the outer parts of the circles, similarities in the area where they overlap.

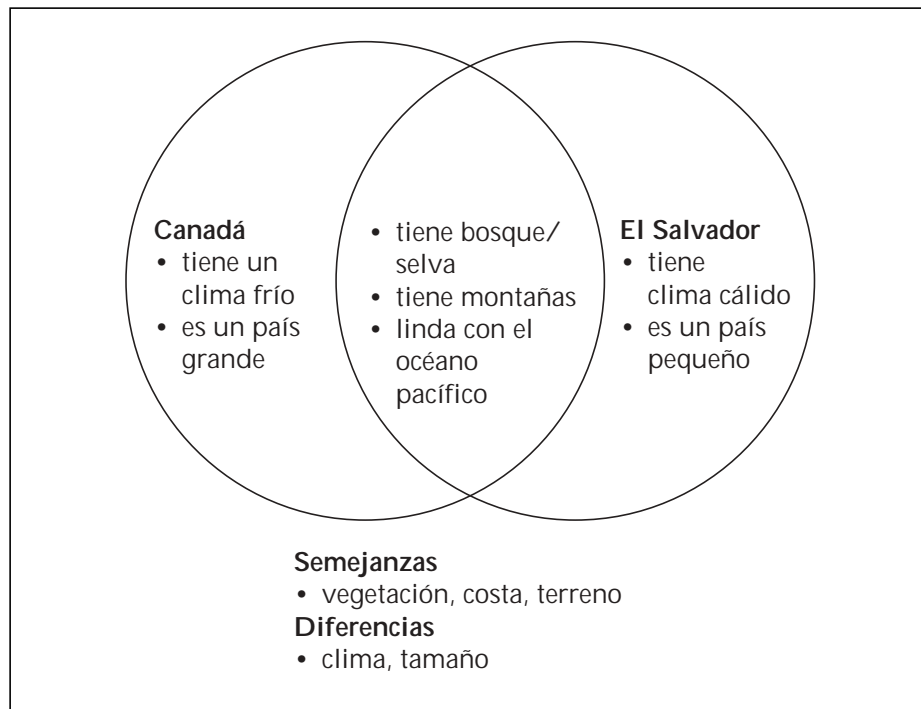

Language Development

Graphic organizers are used for a wide variety of purposes in the second language classroom. They can help students

- organize information they have heard, viewed, or read
- remember vocabulary by making connections with words or phrases they already know
- plan an oral or a written text
- better understand the way texts of different types are structured and organized
- prepare for a listening, reading, or viewing activity by anticipating what they might hear or see
- learn new concepts by relating them to what they already know
- represent what they know about a topic.

Discussions

A discussion is an oral exploration of a topic, object, concept, or experience. All learners need frequent opportunities to generate and share their questions and ideas in small and whole class settings. Teachers who encourage and accept students' questions and comments without judgement and clarify understandings by paraphrasing difficult terms motivate students' interest in using the Spanish language and the exchange of ideas.

The teacher or student initiates the discussion by asking a question that requires students to reflect upon and interpret films, experiences, read or recorded stories, or illustrations. As students question and recreate information and events in a film or story, they clarify their thoughts and feelings. The questions posed should encourage students to relate text content to life experiences and to other text. Interpretations will vary, but such variances demonstrate that differences of opinion are valuable.

Grammatical Problem Solving

Definition

A method often used to teach grammar is to present students with a rule, provide them with examples, and then have them do exercises to determine if they understand the rule and to help them learn through repetitive drill. Grammatical problem solving involves having students use deductive reasoning to discover rules and understand grammatical concepts on their own. Instead of working from the rule to the examples, students work from the examples to the rule.

Procedure

1. Provide students with a number of examples that illustrate a particular grammar rule that you want them to learn. Ask them to look at the examples and try to determine what the rule might be. It is useful for students to work in pairs or small groups, and discuss their reasoning.
2. If their first attempt at deducing the rule is not successful, provide more examples that are designed to lead them in the right direction. It is also helpful to provide contrasting examples to guide the thinking of students. Continue in this way until they have discovered what the rule is.
3. Once students have figured out the rule, ask them to provide their own examples to check for understanding.

Tips

It is not important that students use the proper grammatical terminology as long as they are able to explain what they mean. Often if students formulate the rule in their own words, they will be able to remember it better.

Start with a fairly simple rule if students are not used to this method. It may take some practice for them to be able to formulate rules of their own.

Applications

This method can be used to teach almost any language rule. Here are some examples:

1. Pronunciation (hard sound versus soft)

<u>c</u> ien	casa	gana	gira
	cuenta	guante	general
<u>c</u> irco	cola	gol	

2. Grammar (singular/plural)

el <u>libro</u>	los <u>libros</u>
la <u>casa</u>	las <u>casas</u>

3. Spelling

inte <u>l</u> igente	inte <u>ll</u> igent
artista <u>a</u>	artist
acc <u>í</u> ón	act <u>i</u> on

4. Verb Tenses

Ayer estudié	mañana estudiaré
hablé	
miré	

Language Development

Having students discover or deduce the rule themselves usually leads to a better understanding of the grammatical rule or concept. It also develops their ability to learn language independently. Being able to deduce rules from multiple examples is an effective language learning strategy.

Reflective Discussions

Reflective discussions encourage students to think and talk about what they have observed, heard, or read.

Reflective Thinking—A method in which students reflect on what was learned after a lesson is finished, either orally or in written form.

Two possible approaches to reflective thinking are (1) students can write in a journal in their own words: the concept learned, comments on the learning process, questions, and interest in further exploration; (2) students can answer an oral questionnaire addressing such questions as “Why did you study this? Can you relate it to real life?”

Reflective thinking strategy is an effective tool to

- help students assimilate what they have learned
- help students connect concepts to make ideas more meaningful
- foster additional opportunities to use the target language in a meaningful setting

Interactive Instruction Methods

Interactive instruction methods employ groups of learners. Before the group members get to work, it is important for them to be aware of what they are to accomplish, how much time they have, and what the recording or reporting procedures are.

Brainstorming

Brainstorming is a strategy for eliciting ideas from a group and communicating them in Spanish in oral or written form.

Students contribute ideas related to a topic. All contributions are accepted without initial comment. After the list of ideas is finalized, students categorize, prioritize, and defend selections.

Brainstorming is an effective tool to

- reveal background information and knowledge of a topic
- disclose misconceptions
- help students relate existing knowledge to content
- strengthen Spanish communication skills
- stimulate creative thinking

Brainstorming is a technique for producing the greatest possible number of ideas around a question or a topic. Originally developed to stimulate creativity, this technique is now commonly used in classrooms to encourage students to explore what they know or want to know about a topic.

Brainstorming is most effective when

- all statements are accepted
- quantity rather than quality is emphasized
- no criticism is given, anything goes (no matter how outrageous or far-fetched)
- no discussion or judgments except for clarification purposes
- people can build on other ideas
- a fixed time is allocated
- once ideas have been generated, they can be combined or ordered

Teachers may decide to assess brainstorming when it is used in the context of cooperative learning groups. Anecdotal records may be the preferred method of recording data.

Brainstorming is particularly useful in the following situations:

- to explore possible solutions to a problem
- to get ideas for a writing project
- to explore what students know about a topic
- to explore questions or topics for further research

This technique may not seem well suited to the second language classroom at first, since students will sometimes have difficulty expressing their ideas in the second language. It is, however, very useful for developing vocabulary and structures at the beginning of a unit. Here are a few ideas to make it more successful in second language classrooms:

- Before using brainstorming on a topic that is unfamiliar to students, have them read a text, view a film, or do an activity that will introduce them to some of the vocabulary and expressions they will need.
- Encourage students to use gestures, illustrations, and paraphrasing if they cannot think of the exact word they need.
- If students use English to express their idea, give them the equivalent word or expression in the second language and write it down with the other ideas, adding a drawing or brief explanation so that they can remember what it means.
- If you can't think of the word, do not be afraid to admit it and use a dictionary to find the correct term or spelling.

Categorizing

Categorizing involves grouping objects or ideas according to criteria that describe common features or the relationships among all members of that group.

This procedure enables students to see patterns and connections; it develops students' abilities to manage or organize information. Categorizing is often used to organize the information produced during a brainstorming activity.

Assessment might include monitoring students' ability to understand relationships among items, categorize items using more than one criteria or category, and categorize items independently.

Circle of Knowledge

This method involves each student in thinking and discussing a topic with peers before sharing ideas with a large group. Students take turns going around the circle. The circle of knowledge method is used in the same manner as reflective discussion.

Cooperative Learning

Cooperative learning is a method in which students work together in small groups to achieve a common goal, while communicating in Spanish. Cooperative learning involves more than simply putting students into work or study groups. Teachers promote individual responsibility and positive group interdependence by making sure that each group member is responsible for a given task. Cooperative learning can be enhanced when group members have diverse abilities and backgrounds.

After organizing students into groups, the teacher thoroughly explains a task to be accomplished within a time frame. The teacher facilitates the selection of individual roles within the group and monitors the groups, intervening only when necessary, to support students working together successfully and accomplishing the task.

Cooperative learning is an effective tool to

- foster interdependence and pursuit of mutual goals and rewards
- develop leadership skills
- increase the opportunities to use Spanish in authentic, communicative situations
- increase participation of shyer students
- produce higher levels of student achievement, thus increasing self-esteem
- foster respect for diverse abilities and perspectives

Cooperative learning embraces a number of interactive instruction methods that involve students working in small groups to complete a task or project. The task is structured in such a way that involvement of each group member contributes to completion of the task. Success is based on the performance of the group rather than on the performance of individual group members.

Cooperative learning stresses interdependence and promotes cooperation rather than competition. Establishing and maintaining cooperative group norms develops the concept of a community of learners. Cooperative learning activities are carefully structured to include five basic elements:

Positive Interdependence: Each member of the group is concerned about the performance of other group members as well as their own. All individuals must succeed for the group to succeed.

Individual Accountability: Each member of the group is responsible for the work of the group.

Face-to-face Interaction: Students work in environments that facilitate communication and cooperation.

Social Skills: Students are directly taught the human interaction skills that enable groups to function effectively.

Group Processing: Group members have opportunities to receive feedback on how their group has been functioning and make plans to improve.

Cooperative learning activities can be structured in many ways (see applications below), but these five elements should be present in some form or other.

Procedure

1. **Positive interdependence** can be structured into group activities in a number of ways:

- Students have a common goal (e.g., every member must contribute to making a single product or all members of the group must improve their score on a quiz).
- Students receive the same reward for completing the task (e.g., their group project is displayed in the school or each group member receives bonus points to add to their individual score).
- Students share one set of materials or information (e.g., the group gets one large sheet of paper, one set of coloured pencils, one ruler, and one eraser to produce a map).
- Each member of the group is assigned a complementary and interconnected role (e.g., in a group of two, one person cuts and the other glues; or in a group of four, students share the roles of reader, writer, timekeeper, and noise monitor). Direct teaching of different roles within the group may be necessary. Rotate the roles so that all students have the opportunity to develop their skills in different roles.
- Each member of the group is responsible for carrying out one step of an overall task that needs to be done in step-by-step order (e.g., when preparing a dish, one group member is responsible for gathering ingredients, another for measuring, another for mixing; or when producing the final copy of a letter, one student checks the spelling, another checks the grammar, another checks the page layout, and another checks for capitalization and punctuation).
- Students work together against an outside force or constraint (e.g., team members try to beat their previous team score on a quiz or they try to find the most words related to food in a set period of time).
- Members of the group choose a group name, motto, logo, flag, song, or chant to help establish a feeling of identification with the group.

2. **Individual accountability** is created when any member of the group may be called upon to present the work of the group, defend a decision taken by the group, or answer questions about the project the group has been working on.
3. **Face-to-face interaction** is facilitated when the conditions of work allow the students to work together easily. They can, for example, be grouped around a small table if they need a work surface, or on chairs in a circle if they are just talking. Sometimes pulling desks together means that students are too far apart to talk in soft voices and still be heard by each other.
4. **Learning social skills** is essential if cooperative learning activities are to work well. There are basically two kinds of cooperative skills, those which students use to complete the task (e.g., asking questions, listening actively, staying on task), and those they use to build and maintain the working relationship of the group (e.g., disagreeing in an agreeable way, encouraging others, keeping things calm). Students need to be taught specific skills before they begin their group activity:
 - Decide which skills to work on. Concentrate on one or two at a time, depending on the age of the students and their previous experience in cooperative groups.
 - Help students understand why they are learning the skill, what the skill is (by modelling it, for example), how they can practise it, how well they use the skill, and how they can improve.
 - Students learning a second language, in particular, need to be taught specific vocabulary and structures for working in groups. For this reason, some of the specific outcomes deal with language functions involved in managing group actions.
 - Students need a variety of opportunities to practise the skill. This encourages them to transfer the skill to new situations.
 - In addition to providing feedback yourself, ensure that students evaluate their use of the skill both individually and as a group.
 - Assessment of the social skill should be part of the overall assessment of the activity.
 - Monitoring the groups as they work will show which cooperative skills are lacking and might become the focus in future lessons.

5. Group processing usually takes place at the end of the activity. Students discuss how well their group is functioning and how they may improve the group's effectiveness. This self-assessment may be done individually (e.g., "How did I contribute to the effectiveness of the group?") as well as in the group, and then shared with the rest of the class. Alternatively, one of the roles assigned in the group can be to monitor the use of a specific skill and report back to the group.
6. The kinds of roles assigned to group members depend on the task they are doing and on the skills they have already developed. Individual role cards, outlining the specific behaviours of each role, may be prepared as references for students while working in groups. Some examples of general roles are facilitator, recorder, encourager, observer, and summarizer. Some examples of roles that might be needed for specific tasks are materials handler, timekeeper, reader, and summarizer.

Tips

If students have little experience working in cooperative groups, start small with groups of two or three students. As they gain more experience and skill, they will be able to handle larger groups. The size of the group will also depend on the nature of the task.

When introducing cooperative learning, begin with a clear, concise task, simple roles, and basic social skills like talking with quiet voices.

It is usually better to group students with different levels of ability, different aptitudes, or different backgrounds. Each student's strong points will be different and each will be able to make a contribution to the group as well as learn from the others.

Students can stay in the same group for varying amounts of time, sometimes for only a few minutes, sometimes for a whole unit if they are working together on a particular task.

The teacher's role while groups are working is to observe student progress, record observations to provide feedback, and to intervene if necessary. When intervening, try to find ways to turn the problem back to the group members for a solution.

Students need time, practice, and explicit instruction to become good at working together cooperatively. Don't expect students to develop interpersonal skills automatically.

Applications

1. **Informal Groups**

Informal groups are usually small (two or three students) and short-term (a single activity or class). Groups can be formed very quickly by asking students to turn to their neighbour and do something together for a few minutes. Some examples of what students can do in informal groups are

- guided exercises such as practising dialogues and cloze activities
- brainstorm or come up with lists of words, ideas, and so on
- express a personal opinion on a film, a song, a current event
- give a brief report on strategies they have been trying, Internet sites they have visited, and so on

2. **Home Groups**

Home groups are often small as well, but are usually maintained for a long period of time, often throughout the whole course. It is important that members of a home group feel at ease with each other since they will be working together over an extended period of time. Students can be asked to name three or four other students they would like to work with and these suggestions can be used to constitute the home groups.

A home group provides on-going support, both socially and academically, for every member of the group. Learning a second language can be stressful for some students, but they will learn better if they are relaxed and confident.

Home groups can provide support to students in a number of ways:

- checking homework
- correcting notes
- studying for exams
- discussing strategies
- exchanging information about opportunities for using the language outside the classroom
- discussing problems

3. Jigsaw

The jigsaw method is a way of organizing cooperative learning groups to share the workload on larger projects. It involves several steps and two different kinds of groups.

- The students start in their home group or base group. The teacher explains how the project will be organized, outlines what the students' responsibilities are, teaches the social skills that will be worked on throughout the project, discusses assessment, and so on. Within the home groups, each student accepts to work on a particular aspect of the project, to become the "expert" on that part of the project for their group.

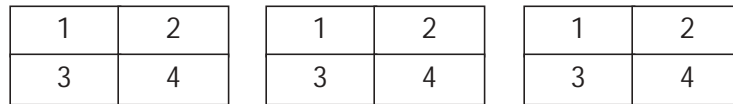

- Students from each home group who will be the "expert" for their group on the same topic come together to form expert groups. In their expert groups, they work on the particular aspect of the project they are responsible for, and decide how they will present this or teach it to the other members of their home group.

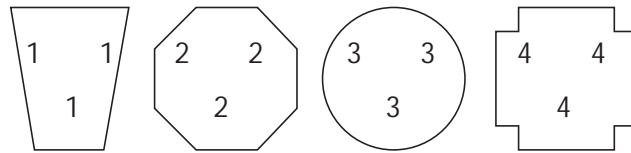

- Once students have finished the work in their expert groups, they return to their home groups, where they use what they have learned in their project, teach it to the others in the group, and remain the "expert" for their group on this particular topic.

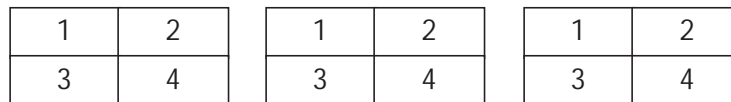

- The jigsaw technique is particularly useful for some of the tasks that students will be doing in a task-based language learning class.

Language Development

The language needed to work effectively in small groups can become an important component of a second language class, provided the time is taken to explicitly teach the vocabulary and structures necessary. Almost all of the functions set out in the Applications component of the curriculum guide will be necessary at some time or other in cooperative group activities.

It is important to make clear to students that communicating in Spanish is an expectation of their work in cooperative groups. Making it part of the assessment, assigning a language monitor as one of the roles, and teaching ways of helping each other are different ways of doing this.

Cultural Presentations

A cultural presentation is an exhibit that is focused on aspects of the target culture.

Students work in groups to create exhibits that represent a particular aspect of the target culture.

A cultural presentation is an effective tool to

- develop critical thinking skills
- develop the ability to select important high points
- encourage creativity and individuality
- deepen specific knowledge of the target culture

Ideas for Spanish Cultural Participation and Research Projects

If you like to draw, paint, build, cut, paste, or if you like the visual arts, consider the following:

- Make a map of a Spanish-speaking country or region. It should focus on a special topic such as agricultural products, manufactured items, costumes, geography, etc.
- Make a poster about a famous Spanish-speaking person (artist, scientist, political/historical person, athlete). Include a short biography and describe highlights of his/her career, when he/she lived, why important, etc.
- Imitate a famous Hispanic artist's painting or style in a painting of your own creation. Include a paragraph about the artist, which highlights his or her style of art and time period (Picasso, Velazquez, Goya, Miró, Rivera, Zurbarán are just a few starters).
- Make your own reproduction of a painting by a famous Hispanic artist. Include a paragraph about the artist, which highlights his or her style of art and time period (Picasso, Velazquez, Goya, Miró, Botero are just a few starters).

- On a map of North America, find concentrations of cities or natural features with Spanish names. Make a map, research the Spanish history of the area and include translations of names.
- Visit an online art museum (see web resources in the Appendices), and document Hispanic artists on display, giving titles of works, and writing your reactions to them. (If you like to sketch, quick sketches of a couple of the pieces you view would make great evidence!)
- Draw a comic strip to tell about an important historical event, famous person, or cultural practice.
- Visit a local or online gallery or exhibit featuring Hispanic artists, and document the art you saw there. Ideas for how to document the art include your own sketch of a piece of art which you like, videos, or photos (if you get permission from the exhibit managers before going there), a critique of what was good, bad, or interesting about the art you viewed, etc. (Check the entertainment sections of local newspapers and magazines to see what exhibits are available.)

If you like to cook or eat, consider the following:

- Go to a Spanish (or Guatemalan, or Peruvian, etc.) restaurant or café and order in Spanish. (Make sure someone speaks Spanish! Call to ask before you go!!) Get a signature on the menu or a business card. Document with video or photographs. Sample Spanish food you've never tasted before.
- Research what a typical dinner would be in a Spanish-speaking country. Make at least three courses for your family and/or friends. Document with copies of the recipes, and you **must have** photos or video.
- Cook a typical **main dish** of a Spanish-speaking area and bring samples to class. **Remember to bring utensils, napkins, etc.** (You'll bring this on a pre-arranged day and present it to the class.) You will need to sign up with the instructor prior to your presentation day. **Just salsa and chips is not acceptable.**
- Interview a Spanish speaker about customs at table such as how to hold utensils while eating, where to place hands while eating, what it's okay to eat with fingers, etc. Demonstrate to class.

If you can sew or use your hands well, consider the following:

- Sew a regional or historic Spanish costume. Document when and where the costume is from and who would wear this type of clothing. Model the costume for the class if it's full size. Bring the doll if you dress a doll.
- Build (using kits if you like) models of a famous building or monument of a Spanish-speaking country. Include a brief report about the monument or building. What is it called? When was it built? What was its purpose? Who had it built? What is it used for today if it has changed from its original purpose?

If you like to read or write, consider the following:

- Read a Spanish magazine or newspaper article (Yes, in Spanish!). Summarize the main points you learned in an outline or a graphic organizer. (See your teacher for magazines you can use. You can also find newspapers and magazines online.)
- Read a Spanish novel in translation.
- Read a Spanish children's book. Write a short plot summary in English and a list of new words learned. (There are lots in the library!)
- Read up on some aspect of Spanish culture (e.g., family, table manners, manners when visiting someone else, participating in sports, etc.), and then write a letter to a friend as though you were living in a particular Spanish-speaking culture and describing to your friend what life was like for you living there. There are great books available to use as resources. See your teacher for ideas.
- Read up on an aspect of a Spanish-speaking country's history and write a series of journal entries as though they were written by a person who had lived through them.
- Write to the tourist offices of various cities in a Spanish-speaking country requesting information. Submit a copy of your letter, materials received, and a write-up. Use these materials to decide where you would go on your ideal Spanish vacation, and present it visually (e.g., in a poster, an ad campaign to convince someone else to visit there, an "infomercial" video to be used as advertising for the area, etc.). Let your creativity be your guide for how to present what you learn.

- Using tourist resources such as guidebooks, travel agencies, and the Internet, plan your ideal vacation in Spanish-speaking parts of the world. Where would you go? What would you see? What kind of money would you pay in? What would there be to eat in the places you visit? What recreational activities? You may present this information as a travel journal pretending you've already completed the trip, as a travel agent's suggested itinerary for a customer, as though you're a travel writer telling people what to do, etc.
- After researching him or her, "become" a world leader of a Spanish-speaking country and tell the class who you are, why you're important, what you have accomplished, etc.
- Visit the Spanish section of an international bookstore. Describe what types of publications are available.
- Read up on an important event in the history of a Spanish-speaking country, and then write a news article as it might have appeared in the press at the time of the event. (This could be a scientific discovery, a battle, an invention, the defeat of the Spanish Armada, etc. Let your own interests be your guide.)
- Collect and read news articles about a Hispanic country in which you are interested, and then write an article yourself using the collected articles as resources.

If you like television, movies, or performing arts, consider the following:

- "Become" a famous Spanish speaker for the class. Wear an appropriate costume and introduce yourself to the class as that character. Explain what you did that caused you to become famous and when you did it, etc.
- Watch a Spanish movie with subtitles, summarize the plot, keep a list of words you figured out from the movie, and note the things you learned about Spanish culture from watching the movie.
- Memorize and perform a Spanish poem (or make a video of yourself performing the poem).
- Go see a Spanish play (classic or modern) or other musical or theatrical production. Summarize the plot, tell who the playwright or composer was, when (s)he wrote, etc.
- Learn to play or sing a Spanish song. Perform it, teach it to the class, or videotape it.
- Learn and teach a Hispanic dance to the class.
- Make a video to teach an aspect of the culture of a Spanish-speaking country or an aspect of Spanish grammar or vocabulary, or to reenact a scene from literature or history.

- Learn about various Spanish gestures and body language and make a video of yourself using those gestures with appropriate comments in appropriate situations or present them live to the class.
- Perform a scene from a Spanish play for the class in Spanish or English, but identify the playwright and time period.
- Read up on an important event in the history of a Spanish-speaking country, and then write a skit based on that event. (This could be a scientific discovery, a battle, a beheading, an invention, the defeat of the Spanish Armada, etc. Let your own interests be your guide.)
- Attend a concert or performance featuring Hispanic music or dancing.
- Visit a record store that carries a large selection of Hispanic music. Listen to songs available to listen to. Read about the songs. Report on what you learned, what you liked, etc.
- Listen to a mariachi band and talk to the band members. List the songs they played. Find out the names of their instruments in Spanish. Get an autograph from them.
- Watch MTV International with Daisy Fuentes, record or videotape songs in Spanish for the class, and complete a *teletarea* form (viewing log) for the viewing.
- Watch two hours of Spanish programming on local TV and fill out *teletarea* forms (viewing logs) for what you watched.
- Watch the news five times in Spanish and summarize the headlines on a *teletarea* form (viewing log).

If you like sports, consider the following:

- Learn the Spanish vocabulary for a sport commonly played in a Spanish-speaking region or country. Present your knowledge in a poster that includes illustrations and Spanish terms for key vocabulary, or teach the class the basics of the game in Spanish.
- Make a video for a sport with a narration in Spanish. (You may use a game from television and create your own narration for a five-minute period of the game.)
- Watch an hour of sports such as *lucha libre* or *boxeo* on Spanish-speaking TV, and complete a *teletarea* form (viewing log).
- Learn the Spanish vocabulary for a sport commonly played in Spanish-speaking countries. Teach the class the key vocabulary you learned.

Other possibilities include the following:

- Interview a native speaker about his or her country, using video or audiocassette.
- Make up a game for the class which requires the use of Spanish and knowledge of a Spanish-speaking country's culture for the game to be played. (Schedule a time with the teacher for it to be played in class.)
- Visit Hispanic stores in South Sacramento and summarize your activities, what you saw, what Spanish you got to speak, etc.

If you like computers, consider the following:

- Exchange five letters or emails with a native speaker of Spanish, and turn in copies of correspondence.
- Check out the weather on the Internet in several Spanish-speaking cities around the world. Show the locations of those cities on a map, and show what the weather was, using appropriate meteorological symbols and a map legend in Spanish.
- Make a list of cool Spanish-language websites you discover that can be duplicated for classmates. Give a brief description of what each site is about.
- Work with a language-learning program in Spanish and print out the lessons you have done as your evidence.
- Discover, read, interact with, and react to three Spanish-language web pages. (Include information you download from those pages as part of your documentation.) Your write-up will be crucial in convincing your teacher that you learned a lot and that this was a valid project.
- Design your own project based on something you discover on the Internet. Discuss your ideas in advance with your teacher to be sure it is acceptable. (The project must cause you to use Spanish and/or learn about a Spanish-speaking country's culture, not just print out what you find online).
- Visit a Spanish language catalog web site and put together your no-holds-barred holiday wish list. What are the names of the items you want? How much do they cost? In what currency? Is it something you'd find here?

If you are interested in business or in career opportunities using Spanish, consider the following:

- Interview a manager of a business operating locally that has its home or affiliated offices in a Spanish-speaking country. Learn what is involved in doing business between the two countries. Prepare your questions in advance and record your interview.
- Visit a local post-secondary institution offering Spanish courses, or a private Spanish-language institute where learning other languages to use in “the real world” is the focus.
- Research a career in which command of Spanish will be useful. (See your counsellor, a research librarian, or your teacher to discuss how to research this project.)
- Research a specific Hispanic business. In your write-up, profile the company (product, location, size of work force, gross sales, etc.) Try to contact someone working for the company you select (phone, email) and see whether he or she is willing to discuss with you how Spanish is useful to employees.
- Research the use of Spanish in an overseas business or nonprofit organization (e.g., health organizations, religious organizations, etc.) by interviewing someone who has used Spanish while living and working in a Spanish-speaking country. Also include questions to your interviewee about what it was like to live there and adjust to that culture.
- Job shadow someone who uses Spanish in the workplace for two hours.
- Interview Spanish translators who work for a translation company. (See the yellow pages to look for possibilities.)
- Visit the international sales department of a locally based export or international services business and learn how it conducts its international marketing and the steps and processes involved in international sales and in shipping product overseas.
- Interview an employee of a Spanish-speaking business about the challenges of doing business across cultures.
- Research and report on international management degree programs at schools such as the Monterey Language Institute, the American Graduate School of International Management, or the university of your choice. What career opportunities will such a degree bring you? What language requirements does the program have? What is their job placement rate for graduates, etc.?

- Interview people who use Spanish in their jobs, such as radio or television personalities, journalists (available through the *Bee* and *La Voz*), health care workers, law enforcement workers, etc. Find out why Spanish is useful to them. How good does their Spanish have to be to be helpful to them? How did they learn it? Why?

If you like to travel, consider the following:

- Photograph street and shop signs on a trip to Mexico; report on their significance. (You could do something similar with architecture, churches, types of stores, etc.)
- Visit Mexico and compare Spanish influences to Indian influences.
- Pretend to be a travel agent and plan an imaginary trip through a Spanish-speaking area. Use illustrations, maps, and texts to present this itinerary to your “client.”
- Visit a Spanish-speaking area and document your visit through videos or photographs to share with the class.
- Keep a travel log if you travel to a Spanish-speaking area.

If you like history and geography, consider the following:

- Visit a Spanish mission in California and learn about its history and architecture.

If you want to practice your Spanish, consider the following:

- Interview someone from a Spanish-speaking country about customs, traditions, holidays, attitudes, etc. in his/her country.
- Attend a *quinceañera*, *boda*, or *fiesta* in a Hispanic community.
- Attend a church service that is conducted in Spanish.
- Exchange three letters with a Spanish-speaking pen pal.
- Write a children’s book with illustrations and text in Spanish. The book should be based on something you have learned about Spanish culture, not American culture. (Alphabet and numbers books are not accepted.) See the teacher for ideas about an aspect of culture to incorporate into the story. It should be a story simple enough to tell in Spanish. (Don’t write it first in English!)

Information Gap

Definition

In an information gap activity, each person has certain information that must be shared with others in order to solve a problem, gather information, or make decisions.

Questions asked in second language classes are often “display” questions. In other words, the person asking the question already knows the answer and is, in effect, simply prompting his or her partner to demonstrate that they know the vocabulary in question. No real communication takes place. Information gap activities involve a real exchange of information, although the situation might be an artificial one.

Information gap activities are often done in pairs, although they can be teacher-led or involve groups of students.

Procedure

Information gap activities can be highly structured or fairly open-ended. In either case, they are most often used for reinforcement of previously learned vocabulary and structures.

- Explain the activity to the students. Make sure they understand that they cannot show the information to their partner. They must communicate verbally.
- If necessary, review the vocabulary and structures that will be needed to complete the activity.
- Once students have completed the activity, they can assess the accuracy of their communication by comparing the information they have.

Tips

When preparing the information gap activity, try to make the situation as realistic as possible so that the questions asked and the answers given are the same as or similar to what might happen in real-life situations.

Make sure that the students have a purpose for exchanging information, for example, a task to complete, a puzzle to solve, or a decision to make.

The first time you involve students in information gap activities, demonstrate in front of the whole class, so that students understand that they cannot just show their information to their partner.

Applications

Information gap activities can be organized in many different ways. The following are a few examples of activities involving pairs of students:

- Ask students to draw the same picture (e.g., a house) simultaneously. (Drawings may be done on adjacent computers using a drawing program.) Students must together choose where to draw the house, its size, what colour different parts are, and so on.
- Student A has a chart showing results of a survey (e.g., what time different people get up and go to bed), but some of the information is missing. He or she must ask student B, who has the missing information, in order to answer a question—who sleeps the longest?
- Student A has a map showing the location of a number of buildings. Student B must ask questions to find out how to get from where he or she is to the building they need to find (e.g., the post office [*el correo*]).

Communication gap activities can also involve groups of students:

- Students are asked to write a short text (e.g., a description of a family member). After they have gone through the usual process of drafting, writing, and editing, and the teacher has corrected the text, they rewrite the text with some information left out (e.g., Francisco has blue eyes and _____ hair. [*Francisco tiene los ojos azules y el pelo _____*]). Other students read the altered text and ask questions to fill in the missing information.
- Jigsaw activities are also information gap activities. For example, each student in the home group is given part of a text on the topic of the unit. The information in the text will usually be needed to complete a specific task. Together they have the whole text, but no single student has all the information. Students regroup with other students from different home groups who have the same part of the text, and they work together to understand all the information. They then return to their home group to share the information with the others and complete the task together.

Teacher-led information gap activities can involve the teacher asking questions for which he or she does not already know the answer. Alternatively, they might take the form of guessing games (e.g., Guess which classroom object is in the bag. Is it a pencil? Is it a notebook?).

Language Development

Information gap activities provide students with opportunities to practise vocabulary and grammar structures in more interesting ways. Motivation is usually high because forms and functions are used for a real, although contrived, exchange of information.

Interactive Language Tasks

In Interactive Language tasks, at least two students work together to accomplish a meaningful Spanish language activity.

The teacher organizes the class into small groups or pairs that then perform a specific task using language. Examples of tasks include finding differences and similarities, identifying objects or persons, arranging things, giving and following directions, interviewing, surveying, choosing, explaining, and solving problems.

Interactive language tasks are effective tools to

- foster interdependence and pursuit of mutual goals
- develop communication skills
- strengthen listening skills
- provide opportunities to use the target language

Language Experience

Definition

When using the Language Experience method, students experience something together, and have the opportunity to discuss it in detail. They then dictate sentences about the experience to the teacher who writes them down word for word. The text thus created is corrected, reread, and used for a variety of reading and writing activities.

Procedure

Begin with an activity or experience in which the students are all involved. It can be anything that the students do as a large group—a field trip, a shared story, baking something, doing a role play. Discuss the experience orally, encouraging students to recall and describe the event in as much detail as possible.

Then each student dictates a sentence about the common experience as the teacher writes it on large sheets of chart paper. The teacher models excellent writing skills, leaving space between the words, using upper and lower case letters appropriately and correct punctuation. It is helpful to go back frequently and reread what has been written. Ask students if there is anything they want to change. After everyone is happy with the content, go back and point out any errors and correct them together.

The text can then be used for a variety of reading and writing activities:

- The text can be typed and copies sent home to be shared with the family.
- The original text on chart paper can be posted in the classroom for the students to reread. It can also be rewritten as a book to be kept in the reading centre.

- Students can use words from the text in their own writing or to make personal dictionaries or word banks.
- Students can copy their own sentence or the whole text. They can add illustrations to help them recall the meaning.
- Cut the words apart and have the students put them back in the correct order.

Tips

It is important to accept the contributions of all students and to use their own words in the text. Errors can be corrected by the whole group together after the text is complete.

During the process of correcting the text, model the use of appropriate strategies such as using references to check spelling and grammar.

Keep the texts fairly short, especially for younger students.

This method can also be used with small groups or individuals, and is suitable for students of all ages.

Use this method to write texts of all kinds, including fiction.

Applications

This method is particularly effective for students who have some oral fluency, but have not learned to read or write the language. Students find the text easy to read because it is written in their own words. This, in turn, increases their self-confidence and their motivation to read more.

Students are motivated by this method because their own language and life experiences are valued. They can show the texts with pride because they have written them and are able to read them.

Use the Language Experience method to reinforce oral language and to teach reading. It is not suitable for introducing new concepts.

This method is also a way of producing texts for reading in situations where it is difficult to find texts that are at the appropriate level for students or on topics that are relevant and of interest to them.

Language Development

The Language Experience method is one of the most effective for teaching reading and for second language acquisition in general.

- It integrates listening, speaking, reading, and writing. The students are exposed to the vocabulary and structures in both written and oral form.
- By beginning with texts that the students themselves have composed, the reading and writing process is directly connected to the experiences and previous knowledge of the students.

- Students are able to build language skills such as word recognition using texts that are meaningful to them.
- Less proficient students benefit from working with texts that more proficient students have created about topics they are familiar with because they have shared in the experience.

The Learning Cycle

The Learning Cycle includes a sequence of lessons designed to have students engage in exploratory investigations, construct meaning out of their findings, propose tentative explanations and solutions, and relate Spanish language and culture concepts to their own lives.

The teacher engages the learners with an event or question to draw their interest, evoke what they know, and connect with new ideas. The students explore the concept, behaviour, or skill with hands-on experience. They explain the concept, behaviour, or skill and define the terms, then use the terms to explain their exploration. Through discussion, the students expand the concept or behaviour by applying it to other situations.

The Learning Cycle is an effective tool to

- encourage students to construct their own understanding of Spanish language and culture concepts
- promote empathy and understanding for people of other cultures
- provide hands-on experience to explore concepts, behaviours, and skills
- develop the ability to share ideas, thoughts, and feelings
- provide opportunities to use the target language

Surveys/Encuestas and Interviews/Entrevistas

Surveys and Interviews are methods for gathering information and reporting.

Students prepare a set of questions and a format for the interview. After conducting the interview, students present their findings to the class.

Surveys and interviews are effective tools to

- foster connections between ideas
- develop the ability to interpret answers
- develop organizational and planning skills
- develop problem-solving skills
- provide opportunities to use the target language

Definition

Students collect information from a sample of people to determine the frequency of particular responses. They then analyze the data and prepare a report on the results. Using surveys as an instructional method can also develop students' numeracy as well as their creative and critical thinking.

Procedure

The first time students do a survey, it is helpful to go through the procedure at least once as a whole class. After they have more experience, they will be able to plan and carry out a survey in small groups.

There are basically four steps to a survey: planning, collecting the data, organizing and displaying the data, and summarizing and interpreting the data.

1. The planning stage involves deciding which questions to ask, formulating the questions, deciding whether the questions will be asked orally (interview) or in writing (questionnaire), choosing the sample of people to survey, and dividing up the work among the students involved. It is at this step that explicit teaching or review of structures for asking questions may be needed.
2. The survey is then carried out in the agreed way. Students can survey other students in the class or school, people in the community, or even people in another community via email or telephone.
3. Once the data have been collected, they must be organized and displayed. The usual method for displaying survey results is some kind of graph. With a little planning in advance, a survey activity in the Spanish class can be integrated with what students are learning in mathematics class. Looking at a variety of different kinds of graphs and interpreting them will provide students with examples, ideas, and models of language to use.
4. Interpreting the findings of a simple factual survey is relatively easy. However, if the survey has gathered information about opinions or values, there is much more room for interpretation. Students may present their findings orally or in writing. In either case, they may benefit from analyzing other reports of the findings of surveys such as might be found in newspapers or magazines.

Tips

The language for reporting results of surveys is somewhat different from ordinary conversation. Students need to see and analyze reports on survey results to discover typical ways of organizing texts of this type, typical sentence patterns, as well as some specialized vocabulary.

Applications

A survey can be carried out on almost any topic. The information gathered can be strictly factual (e.g., month and year of birth, number of people in the family), or it can be more subjective (e.g., likes and dislikes, opinions on a specific topic).

The kind of graph used to represent the results can vary with the age and level of mathematical understanding of the students.

Language Development

Surveys are useful for language development because they provide an opportunity for repetition in an activity where there is a focus on meaning and a purpose. They also provide a natural context for asking questions, using numbers, and making comparisons. If graphs or other visual representations of the results are prepared by students, outcomes for viewing and representing can also be achieved.

Debate

A debate is a discussion in which arguments are presented for and against a statement or resolution. The debate topic begins with “*Que se tome la resolución de . . .*” Debates can take place between two people, or two teams, or can involve an entire class. One side defends the resolution by taking the affirmative view, while the other side (the opposition) argues against the resolution.

Problem Solving

Problem Solving is a learning method in which students apply knowledge to solve problems.

The students discover a problem; problems can be constructed by the teacher or can be real-world problems suggested by the students. The students define the problem, ask a question about the problem, then define the characteristics of possible solutions, which they research. They choose a promising solution that best fits the criteria stated in the definition of solutions, and then test the solution. Finally, they determine if the problem has been solved.

Problem solving is an effective tool to

- allow students to discover relationships that may be completely new to them
- adapt easily for all grade levels and special needs students
- develop the ability to construct new ideas and concepts from previously learned information, skills, and strategies
- promote communicative competence in Spanish

Independent Study

Students should be able to continue to learn after they have left the structured learning environment of the school. If the knowledge, abilities, attitudes, and processes associated with independent learning are to be acquired, they must be taught and enough time must be provided for students to practise.

Independent study is very flexible. It may be initiated by student or teacher; it can include learning in partnership with another individual or as part of a small group. It can be used as the major instructional strategy with the whole class, in combination with other strategies, or it can be used with one or more individuals while another strategy is used with the rest of the class.

It is important to assess the abilities students already possess. Specific skills and abilities may then be incorporated into assignments tailored to the capabilities of individual students.

Computer-Assisted Instruction

This method refers to any instructional program in which the computer performs, manages, or supports some or all of the teacher functions.

Logs and Journals/Diarios de registro o Diarios

Logs and journals can be used as a way to hold private conversations in Spanish with the teacher. Dialogue journals are vehicles for sharing ideas and receiving feedback in Spanish. This dialogue can be conducted by email where it is available.

Students write on topics on a regular basis, and the teacher responds with oral or written advice, comments, and observations in a conversation. In the early stages of learning a language, students can begin by adding a few words and combining them with pictures.

Logs and journals are effective tools to

- develop communication and writing skills
- create a positive relationship between the teacher and the student
- increase student interest and participation
- allow the student to direct his or her own learning
- provide opportunities to use Spanish

Definition

A journal is a notebook in which students record their personal reflections, questions they are wondering about, ideas, words or expressions they want to remember, or feelings they have about experiences in class. Logs are usually more objective, for example, observations on learning activities, lists of books read or films watched, notes on learning strategies, and so on.

Procedure

If students have little or no experience using a log or journal, it is a good idea to model the process by doing a collective journal on large chart paper. Begin by discussing the reasons for keeping a journal and ways it can be used, so that they can better understand the process and the purpose.

- Always begin by noting the date of the entry.
- Specific questions can be asked, especially when students are new to journal writing, to give them some guidance about the kinds of things to write about.
- Provide regular opportunities for students to write in their journals, for example, a few minutes before or after an activity depending on what they are writing about.
- Students choose whether or not to share their journal entries with the teacher or their fellow students.
- If students do decide to share parts or all of their journal, teachers can respond individually with questions or comments to extend thinking. Since the primary purpose of the journal is not to practise writing, teachers should not correct the grammar, spelling, or punctuation in student journals.
- Encourage students to regularly reread what they have written in their journals and reflect on it.

Tips

When doing a collective journal, be sure to go through all the steps of journal writing, including reflection on previous entries, so that students have a model at all stages.

Some students need more guidance in journal writing. They can be given specific questions to answer or sentence stems (e.g., *Mi parte favorita del día es ...*) to get them started.

Although journals are not usually evaluated, they can be a source of useful information and can help the teacher guide the student's learning.

If students are having difficulty expressing their thoughts in words, suggest that they add drawings or other visual representations to express their meaning.

Applications

The different types of journals and logs have different purposes and are used in different contexts.

1. **Personal Journals/*Diario personal***

- Personal journals are often used for students to record their emotional reactions to learning the language and experiencing the culture, and to note their aspirations for travel, education, or other personal uses of their knowledge about the language and culture.
- Students should be reassured that their writing will remain private if they so wish.
- The personal journal can be particularly effective for reflection on experiences with a new culture, since reactions to different ways of doing things are often of an emotional nature rather than intellectual.

2. **Dialogue Journals/*Diario comunicativo***

- Dialogue journals are for journal writing in situations where another person, often the teacher, responds to what the student has written. The resulting journal resembles a conversation in written form.
- The teacher's response to what the student has written should focus on the content rather than the language. The response can be in the form of comments or questions which encourage the student to extend their thinking or reflect on their experience.
- Respond regularly to journals. Other students, parents, or other interested persons can also respond to dialogue journals. Make sure they understand the purpose of the journal and are able to respond in a respectful and thoughtful manner.

3. **Learning Logs/*Diario de aprendizaje***

- Learning logs are very useful for increasing the students' awareness of how they learn (metacognitive learning strategies) and thus developing their strategic competence.
- Students benefit from discussion about what they are learning, why they need to know specific aspects of the language or culture, and how they are learning. The discussion helps them develop the language they need to write effectively about their learning and problem-solving processes.

- Some questions that might be used include the following: What do you know now that you did not know before? What was most difficult about today's class? Why was it difficult? Have you had this problem before? If so, what did you do to resolve it last time? What could you try in future? What do you want to concentrate on in the next class? / *¿Qué sabes ahora que no sabías antes? ¿Qué fue lo más difícil en la clase de hoy? ¿Por qué fue difícil? ¿Antes tenido este problema antes? Si es así, ¿que hiciste para resolverlo la última vez? ¿Qué podrías tratar de hacer en el futuro? ¿En qué quieres concentrarte la próxima clase?*

4. Reading Logs/*Diario de lectura*

- Reading logs are used to help students learn to think about and respond to what they are reading, make connections between their own experience and the story, and generally develop a love of reading.
- Beginners or young readers may simply draw a picture of one of their favorite scenes from the story and add a simple caption.
- As students become more skilled readers and writers, they can write about what they think the story will be about, based on the cover and illustrations, their first impressions when they start reading, and then their reactions as they discover whether or not their hypotheses were correct.
- They can also comment on the language, for example, new words, things they do not understand, interesting words or phrases, aspects of the style (figurative speech, colloquial expressions, etc.).
- Some questions that might be asked include the following:
 - *Si tú hubieras escrito esta historia, ¿hay algo que cambiarías?*
 - *¿Qué te gustó más de este libro?*
 - *¿Te ha sucedido algo parecido alguna vez?*
 - *¿Has leído alguna vez otros libros sobre el mismo tema (por el mismo autor)? ¿Cuál prefieres?*

Language Development

Although the primary goal of journal writing is not to teach the language directly, there can be many benefits of this method for language development. In their journals and logs, students have an opportunity to use language in a different context, as a personal tool for learning. It is also very useful for developing strategic competence and intercultural competence.

Free Writing

Free Writing is a method for encouraging students to express ideas by writing in Spanish.

After reflecting on a topic, students respond in writing for a brief time to a Spanish prompt, a quote, or a question.

Free writing is an effective tool to

- develop the ability to link previous knowledge and experience to a topic
- develop creative and critical thinking skills
- provide opportunities to express and share ideas in written form
- encourage students to value writing in the target language

Personal Dictionaries/Diccionarios personales

Personal dictionaries consist of words that are familiar and significant to students. These words, which students use frequently in oral contexts, can form the basis of reading and writing vocabularies. Word sources included dictated stories and captions, journals and other writing efforts, as well as students' own oral vocabulary. For language learning, personal "banks" or collections of key words are valuable resources. Students may compile word collections to expand their reading and writing vocabularies.

Learning Contracts/Contratos de aprendizaje

Students and teacher work together during the designing, running, and evaluation of personal contracts. Learning contracts may be used to guide students as they work towards outcomes related to using Spanish for fun and personal enjoyment, for example, or the development of metacognitive strategies.

Research Projects/Proyectos de búsqueda

Students may be involved in research projects individually, as partners, or as members of small groups. Research projects are effective in developing and extending language skills. While doing research, students practise reading for specific purposes, recording information, sequencing and organizing ideas, and using language to inform others.

A research model provides students with a framework for organizing information about a topic. Research projects frequently include these four steps:

- determining the purpose and topic
- gathering the information
- organizing the information
- sharing knowledge

Experiential Learning Methods

Experiential learning methods are student-centered. The emphasis is on process, not product.

Experiential instruction strategies are very useful because

- they greatly increase understanding and retention
- students are more motivated because they actively participate and teach one another by describing what they are doing
- they are inductive—illustrations or examples are given and a rule, concept, or generalization is then formulated
- they are activity oriented
- students reflect about an experience, and apply what they have concluded to other contexts

There are five phases:

- experiencing (an activity occurs)
- sharing (reactions and observations are shared)
- analyzing (patterns are determined)
- inferring (concepts are developed)
- applying (plans are made to use learning in new situations)

TPR Storytelling

Based on the Natural Approach, TPR Storytelling combines the effectiveness of TPR with the power of storytelling. TPR Storytelling teaches students to use the vocabulary they have learned in the context of entertaining, content-rich stories. Language production goes beyond the imperative into the narrative and descriptive modes.

The following is a brief outline of the sequence of steps for TPR Storytelling:

Step One: Use TPR Practice and Scenarios to Teach Vocabulary

The teacher uses TPR to teach a small group of words. After introducing a word and its associated action, she “plays with” the vocabulary in TPR practice to provide more comprehensible input. Using gestures, manipulatives, pictures, and familiar vocabulary, she then further reinforces new vocabulary by giving students a series of commands to execute and short scenarios to act out.

For example, in a beginning-level story from textbook *¡Cuéntame más!* (Marsh and Anderson), the following vocabulary items are taught via TPR: the coyote, sees, the bird, wants to eat, grabs, offers. Sample commands might include the following:

Come.

Come un plato grande de espinacas. (¡Aj!)

Come cuatro barquillos de helado. (¡Oh, qué rico!)

Come un pájaro pequeño y un coyote grande.

Agarra al coyote.

Ofrécelo a los estudiantes a tu derecha.

Ofrece un pájaro grande a ese estudiante.

Agarra un coyote y ponlo encima de la cabeza de ese estudiante.

Etc.

After practice with short commands, a sample scenario, which students act out while the teacher narrates, might look like this:

There is a tiny bird. (*El “estudiante pájaro” hace una reverencia y saluda “pío, pío.”*) There is a big coyote. (*El “estudiante coyote” hace una reverencia y “aulla.”*) The big coyote had four sandwiches. The tiny bird wants to eat the sandwiches, so the coyote offers the bird two sandwiches. Yum!

Step Two: Students Produce and Practise Vocabulary Words

Once students have internalized vocabulary words through TPR practice and scenarios, the class divides into student pairs to practice the words. One student in the pair reads the word and the other gives the corresponding gestures, then vice versa. Next, one student does the gesture and the other says the corresponding word.

Step Three: Teacher Presents a Mini-Story that Students Then Retell and Revise

Using student actors, puppets, or pictures from the text, the teacher then narrates a mini-story containing the targeted vocabulary words.

The mini-story and illustrations corresponding to the above vocabulary words are as follows:

There is a big coyote. There is also a tiny bird. The coyote sees the bird. The coyote wants to eat the bird. The coyote grabs the bird. Oh no! But the bird offers the coyote a peanut butter sandwich. What a relief! The teacher uses a variety of techniques to increase exposure to the story and to help the students start telling it:

1. She pauses in the story to allow students to fill in words or act out gestures.
2. She makes mistakes and lets the students correct her.
3. She asks short-answer and open-ended questions. (Is the coyote long or little? Who does the coyote grab? What is the coyote's name? Where does he live?)

Once the story is internalized, students then retell it to a partner. Students may tell the story from memory or may use illustrations or guide words written up on the board as cues. The class then reconvenes and student volunteers retell the story for other students to act out. The teacher may also help the class revise the story, changing a few details about the plot or characters to create a new revision to the original story line.

Step Four: Teacher Presents a Main Story that Students Retell and Revise

Small groups of mini-stories are designed to prepare students to narrate, read, and write a larger main story that uses the vocabulary from the mini-stories. When the entire group of mini-stories has been mastered by the class, the teacher then repeats Step Three to introduce the main story. Once the main story has been presented and acted out, it is reinforced with readings and exercises from the textbook. As with mini-stories, students build upon the main story, using their existing language skills to embellish the plot, personalize the characters, and create revisions.

Step Five: Students Use New and Old Vocabulary to Create Original Stories

Capitalizing on their creativity, students are given opportunities to write, illustrate, act out, and share original stories. Activities may include drama, essays, videotaping, creating student booklets, contests, group/pair work, illustration exercises, back-to-back communication activities, etc.

These are the simple steps at the heart of a complete and comprehensive methodology that allows students to rapidly acquire, internalize, and produce sophisticated language in a fully communicative approach.

Field Trips/Excursiones

This activity allows students to use their language skills in a realistic setting outside the classroom.

A field trip is a planned learning experience for students to observe, study, and participate in expressions of the target culture(s) in a setting off the school grounds, using the community as a laboratory.

Before the field trip, teachers and students plan and structure communicative activities to engage in during the visit and engage in follow-up activities after the trip.

Field trips are an effective tool to

- develop organizational and planning skills
- develop observational skills
- give students an authentic experience of communicating in a foreign language

Focused Imaging/Enfoque imaginativo

This method is the process of internally visualizing an object, event, or situation. It enables students to relax and allow their imaginations to take them on journeys, to experience situations vicariously, and to respond with their senses to the mental images formed.

Games/Juegos

Games are structured or contrived learning or training activities that include conflict, control, and rules for winning and terminating the activities.

Role Play and Simulation/Dramatizaciones y simulaciones

Definition

Children naturally use make-believe to explore a whole variety of roles and situations that, as children, they cannot experience directly. Role play and simulation are methods that use this natural learning strategy to explore different aspects of school subjects. Role play and simulation are both related to drama, but they resemble improvisation more than play-acting or other theatrical performances. Students assume a role (a character, a real-life or imaginary person, sometimes even an animal) and are put in a situation or context. When they assume roles, they are acting “as if” they are someone else. They are experimenting with what it feels like to be in someone else’s shoes and developing empathy with those other lives.

Although some props may be used, generally there is no set, no costumes or makeup, and no script. Students do not try to physically resemble the person they are playing, but they do behave the way they think that person would behave. Role play does not involve writing a skit, and then reading or memorizing it and performing it before an audience. Students are given a role, placed in a situation, and required to act as that person would act in real life. Simulation differs from role play in that it is a more extended and more complex activity and may involve a variety of activities including role-play.

Procedure

Although the kinds of situations used in role plays and simulations are very diverse, the basic procedure is the same. This method is best used at the reinforcement or review stage of learning, when students have a fairly good command of the vocabulary and structures, but need some practice using them in relatively unstructured situations.

Begin by outlining the situation. As students gain more experience in role play, they can take a more active role in planning and guiding the situation. There is usually a problem of some kind that needs to be solved, a conflict that needs to be resolved, or a situation that involves an unforeseen element.

Students may need a period of time for research before they actually do the role play in order to properly play their role. This does not mean writing out a dialogue to deliver. It simply means knowing the background, experiences, beliefs, and opinions of the characters they are playing.

During the role play itself, sometimes everyone is in role, even the teacher. The role assumed by the teacher will vary depending on the amount of guidance the students need. At first, assuming roles such as chairperson of a committee or meeting, spokesperson for a group of protesters, or chief investigator for an enquiry will allow the teacher to guide the role play and encourage students to participate. As the students become more familiar with this method, they can take on some of the more dominant roles in the situation. There should be a clear distinction between being "in role" and "out of role." A signal can be pre-arranged (for example, the teacher puts on and takes off a hat) to indicate the beginning and the ending of the role play.

The period of reflection which follows the role play is just as important as the role play itself. At this stage students describe what they experienced and how they felt. The teacher guides the discussion by asking questions and making comments, encouraging the students to think about their experience. Students may also respond by drawing pictures to express their experience.

Tips

Students need to do a variety of activities before the role play in order to acquire the vocabulary and structures they will need to communicate in the situation they are given. The role play itself provides an opportunity to practise using this vocabulary and these structures in realistic situations, in other words, to bring together and fine tune their previously acquired knowledge.

It is often helpful to incorporate an element of tension into the situation. This “pressure for response” can take the form of a challenge, a surprise, a time constraint, or the suspense of not knowing. Tension is what works in a drama to impel the students to respond and take action.

Applications

Role play is a natural extension of the traditional methods of reading or memorizing dialogues, or of writing skits consisting of short conversations. The advantage of role play is that it places students in a situation which more closely resembles real life, situations where they do not know exactly what the other person is going to say. Role play also provides opportunities to develop other knowledge, skills, and attitudes, depending on the situation. The following examples are only meant to suggest some of the possibilities:

- Begin by role-playing fairly routine situations like asking for directions using a map, ordering a meal in a restaurant from a menu, or buying something in a store. The students must play their roles without a script or a pre-determined dialogue. Gradually introduce variations into the situations; for example, the customer in the restaurant wants something that is not on the menu, or the store clerk is very insistent.
- Students work in pairs, one playing the role of interviewer, the other the person being interviewed. The person being interviewed may be a real person, a character from a story, or a person in a particular role such as the mayor of a large city. The interviewer should have a specific focus for the interview, a particular event to discuss, or a point of view on a particular topic. Both students will need time to prepare for the role play, but they should not write out the interview in advance.
- Imagine a situation, typical of those experienced in the country of origin, which provided the impetus to emigrate to Canada. Role-play a family discussion where some members of the family want to leave and others want to stay. This could be followed by another role play of the same family five years later, after they have moved to Canada. Is the experience what they expected?

- Present students with a case study of a cultural misunderstanding. The source of the misunderstanding could be anything from misinterpretations of gestures, inappropriate use of informal forms of address, or politeness conventions to more fundamental differences based on underlying values or common experiences. Have students role-play the situation, trying to find ways to resolve the misunderstandings. It is also useful for students to experience the same situation more than once but in different roles.
- Situations can be purely whimsical, for example, a meeting to plan for the first voyage to colonize the moon. Students would play the role of colonists, each with individual characteristics, and would have to decide what to take with them, given specific restrictions for volume and weight.

Language Development

Role play is an interactive instructional method and is very effective in developing interactive fluency. Simulation, because it is a more extended and more complex activity, can also involve oral and written interpretation and production. Part of the development of interactive fluency is the acquisition of interactive language use strategies. Discussion of the use of strategies can form part of the reflection process that follows the role play.

Role play allows students to use the Spanish language in a variety of sociocultural contexts that they would not normally encounter in the classroom. This would provide practice interpreting and using language in different registers (different levels of formality), incorporating appropriate methods of non-verbal communication and different social conventions.

The situations and functions (applications) that students can experience during role play and simulation can include conflict situations, problem solving, expressing strong emotions, and other situations that may not arise naturally in classroom interaction. Students have the opportunity to practise their ability to deal with these situations in a safe environment.

Role play and simulation also offer unique opportunities for developing intercultural competence if the situations involve exploring cultural differences, adapting to new situations and ways of doing things, and taking a variety of perspectives. Students can, for example, experience the same situation several times, playing a different role each time.

Combined Grades in the Second Language Classroom

Combined grades is defined as grouping more than one grade level at the same time with one teacher. This situation in the second language classroom is common, especially when the program is new and becoming established within a school program. The term “split grade” is sometimes used interchangeably with “combined grade” or “multigrade.” It is important to note, though, that the term split grade implies separate grades which are taught separately without a connection to the other grade. In a combined grade classroom it is possible for the students to be taught parts of the curriculum together.

Are There Benefits to a Combined Class?

Teachers may feel uncomfortable with teaching a combined class. However, there are many benefits to teaching a combined grade class. There have been educational studies done documenting combined grade classrooms. Studies consistently show that there is no significant achievement difference between students in a one grade classroom and students in a combined grade classroom.

There are other benefits to combined grade classrooms:

- There is social interaction between students of different ages. Through this, the older students develop a sense of responsibility, and the younger students can be challenged and given the opportunity to move ahead.
- It enables students to work at different levels in a way that is not obvious to the other students. For example, an older student with weaker skills can participate effectively and contribute to the group.
- It helps develop independent learning skills and self motivation in students.
- Older students are able to review and internalize their learning through participation in cooperative learning groups.
- The curriculum is taught in a more contextual and thematic manner. This gives the students a more wholistic approach to language learning.
- It increases student confidence in their abilities.
- When a new concept is introduced to one grade level, it is practised or reinforced by the other grade level.

Planning for the Combined Grade

The key to a successful combined grade experience is the process of using effective strategies for instruction and effective planning. The following are successful strategies which will effectively organize planning for instruction.

Thematic Planning

For thematic planning strategies see Planning for Instruction and Assessment, pages 9–11.

Cycling Areas of Experiences

Cycling areas of experiences means that the teacher covers different areas of experience each year for the class as a whole. For example, the Grade 8 and 9 Spanish class will cover certain themes one year and different ones the following year. This will work well if you know that your combined grade class will continue together for a few years.

Combining Concepts

This strategy means that the teacher will combine areas of the curriculum which have similarities and overlap from one grade to the other. The students work together in a variety of activities because curricular outcomes are combined.

When the grammatical elements or certain concepts do not match and the teacher needs to spend time with a particular group there are certain modifications in instructions which may be done. For example, one group may be given a task to do while the teacher is focused on instructing the other grade. The teacher may have a long term project for each grade which may be worked on independently while the teacher instructs the other grade.

Organizational Strategies for the Combined Grade Classroom

Use Cooperative Learning Groups

A combined grade classroom lends itself very well for cooperative learning groups. When organizing these groups the teacher will often put the different grades together (i.e., Grade 8/9 students will sit together in a group). This way the students work together in a mutually beneficial manner. It is this interdependence that is the key to success in a cooperative learning group.

For interactive instruction methods that involve students working in small groups, see pages 76–77 of this section.

Build an Inviting and Positive Atmosphere

The teacher will create a learning environment which is accepting of differences. Students of all levels need to feel that their opinions are valued and that they have an important place in the class. One way the teacher builds a sense of community in the class is through activities which help students work as a team and encourage student participation.

See pages 72–78 of this section.

Assessment and Evaluation in the Combined Grade Classroom

Whether it be in a single grade or a combined grade class, effective assessment practices do not differ. When evaluating a student, it is vitally important that the teacher understand the outcomes and the philosophy of the curriculum. When assessing and evaluating students in a combined grade the teacher may need to adapt certain methods used. The teacher will still need to teach concepts separately and monitor student progress accordingly. Also, the teacher will need to evaluate each student according to the particular curricular outcome for the student's grade.

See Classroom Assessment, pages 9–26, for Assessment and Evaluation strategies.

The situation of having different levels in one classroom is not new. Every teacher has this situation in the classroom. Therefore, effective teaching strategies in the single grade classroom are not different from these strategies in a combined grade classroom.

However, it is critical that that the teacher have access to resources for the range of students in the classroom. The teacher needs appropriate planning time to adapt lessons or units in cases where the concepts are similar to the different grades in the class.

Notes

CLASSROOM ASSESSMENT

A Cyclical Process 4

Meaningful Assessment 5

Guiding Principles for Assessment and Evaluation of
Second Language Learning 6

Assessment Tools and Strategies 9

CLASSROOM ASSESSMENT

Assessment is a systematic process of gathering information about what a student knows, is able to do, and is learning to do. Assessment information provides the foundation for decision-making and planning for instruction and learning. Assessment is an integral part of instruction that enhances, empowers, and celebrates student learning.

Using a variety of assessment techniques, teachers gather information about what students know and are able to do, and provide positive, supportive feedback to students. They also use this information to diagnose individual needs and to improve their instructional programs, which in turn helps students learn more effectively.

Assessment must be considered during the planning stage of instruction when learning outcomes and teaching methods are being targeted. It is a continuous activity, not something to be dealt with only at the end of a unit of study. Students should be made aware of the expected outcomes of the course and the procedures to be used in assessing performance relative to the outcomes. Students can gradually become more actively involved in the assessment process in order to develop lifelong learning skills.

Evaluation refers to the decision making which follows assessment. Evaluation is a judgment regarding the quality, value, or worth of a response, product, or performance based on established criteria and curriculum standards. Evaluation should reflect the intended learning outcomes of the curriculum and be consistent with the approach used to teach the language in the classroom. But it should also be sensitive to differences in culture, gender, and socio-economic background. Students should be given opportunities to demonstrate the full extent of their knowledge, skills, and abilities. Evaluation is also used for reporting progress to parents or guardians, and for making decisions related to such things as student promotion and awards.

Diagnostic assessment may occur at the beginning of a term or a unit of study, or whenever information about the prior learning of a student is useful. Various types of diagnostic assessments (tests, journals, performance-based assessment, etc.) may be used to collect that information. Teachers may use diagnostic assessment to

- find out what students know and can do
- identify student strengths and plan instruction which builds on and extends those strengths

- target difficulties, identify the precise nature of them, and plan instruction to meet those difficulties
- make informed decisions regarding where to focus instructional time and effort

Formative assessment is similar to diagnostic assessment but differs in that it provides ongoing feedback to the teacher about the effectiveness of instruction. Formative assessment encompasses a variety of strategies, used selectively to accomplish one or more of the following purposes:

- monitor student learning and provide feedback to students and parents
- identify areas of growth
- motivate students and provide incentive to study
- help focus attention and effort
- emphasize what is important to learn
- provide practice in applying, demonstrating, and extending knowledge, skills, and attitudes
- encourage goal-setting and monitor achievement of goals
- reflect on program structure and effectiveness, and modify or adjust teaching as necessary

Summative assessment occurs most often at the end of a unit of study. The primary purposes are to determine the knowledge, skills, and attitudes that have developed over a period of time, to summarize student progress.

A Cyclical Process

The evaluation process is cyclical in nature. Each phase is linked to and dependent on the others.

- In the **preparation** phase, decisions are made about what is to be evaluated, the type of evaluation to be used, the criteria against which student outcomes will be judged, and the most appropriate assessment techniques for gathering information.
- The **assessment** phase involves developing or selecting assessment tools, deciding when and how assessments will be conducted, then collecting, organizing, and interpreting the information on student performance.
- During the **evaluation** phase, the teacher makes a judgment on the progress of the student and the level of achievement reached relative to the outcomes.

- The **reflection** phase provides teachers with the opportunity to consider the success of the evaluation process used and to make modifications to subsequent teaching and evaluation.

Meaningful Assessment

Assessment should occur in authentic contexts that allow students to demonstrate learning by performing meaningful tasks. Meaningful assessment achieves a purpose and provides clear and useful information. For example, it may identify misunderstandings in student learning, and provide corrective feedback and direction for further instruction. Assessment improves instruction and learning.

Meaningful content and contexts for assessment help students by engaging their attention and encouraging them to share their work and talk about their learning processes. Students need to take an active part in assessment. When students understand assessment criteria and procedures and take ownership for assessing the quality, quantity, and processes of their own work, they develop self-assessment skills. The ultimate goal of assessment is to develop independent life-long learners who regularly monitor and assess their own progress.

The Teacher's Role in Assessment

In the classroom, teachers are the primary assessors of students. Teachers design assessment tools with two broad purposes: to collect information that will inform classroom instruction, and to monitor students' progress towards achieving year-end outcomes. Teachers also assist students in developing self-monitoring and self-assessment skills and strategies. To do this effectively, teachers must ensure that students are involved in setting learning goals, developing action plans, and using assessment processes to monitor their achievement of goals. Teachers also create opportunities for students to celebrate their progress and successes.

Teachers learn about students' learning and progress by regularly and systematically observing students in action, and by interacting with them during instruction. Because students' knowledge, and many of their skills, strategies, and attitudes are internal processes, teachers gather data and make judgments based on observing and assessing students' interactions, performances, and products or work samples.

Teachers demonstrate that assessment is an essential part of learning. They model effective assessment strategies and include students in the development of assessment procedures such as creating rubrics or checklists. Teachers also collaborate with parents and with colleagues regarding student assessment.

Assessment and Evaluation Purposes and Audiences

The quality of assessment largely determines the quality of evaluation. Valid judgments can be made only if accurate and complete assessment data are collected in a variety of contexts over time. Managing assessment that serves a multitude of purposes and audiences is a challenging task. Teachers must continually balance not only the assessment of their students' progress in the development of knowledge, skills and strategies, and attitudes but also their own purposes and audiences for information collected during assessment.

Guiding Principles for Assessment and Evaluation of Second Language Learning

Classroom-based assessment provides regular feedback and allows teachers and students to reflect on progress and adjust instruction and learning accordingly. See the chart, entitled Principles of Assessment that Assist Learning and Inform Instruction, on page 8. When planning for assessment for second language learning, it is important to consider the following points:

- The teacher should use a variety of assessment techniques that clearly reflect the communicative, learner-centred, task-based approach to second language learning. For example, when using a task-based approach, written interpretation would be tested by having students use the information in a written text to carry out a task, rather than by having students answer comprehension questions.
- The percentage of the final mark allotted to each component of the curriculum should reflect the amount of time that the students spend on that component. For example, if students are spending 70% of their time on oral activities, 70% of their final mark should be determined by oral evaluation.
- Tests should measure what they say they are measuring. For example, if students are being tested for aural interpretation and the test requires that they write down information they have understood, they should be marked on whether or not they have understood, not on whether the information written was correctly spelled.
- Evaluation should take place in the context of meaningful activities. For example, grammar points dealt with in the course of a unit can be evaluated by looking at whether or not they are correctly used in the task the students are doing, not in fill-in-the-blank or other decontextualized exercises.

- Different kinds of outcomes should be evaluated in different ways. For example, knowledge-related outcomes can be assessed by objective tests; attitudes are better assessed by observation.
- Students should be involved in determining the criteria that will be used for evaluating their work. This can be part of the planning process at the beginning of each unit. Students should have a clear understanding of the types of evaluation procedures that will be used throughout the unit.

Principles of Assessment that Assist Learning and Inform Instruction		
1. An Integral Part of Instruction and Learning	2. Continuous and Ongoing	3. Authentic and Meaningful Language Learning Processes and Contexts
<p><i>Assessment . . .</i></p> <ul style="list-style-type: none"> • is meaningful to students • leads to goal setting • fosters integration with other curricular areas and application to daily life • reflects instructional strategies used • uses a wide variety of methods • reflects a definite purpose 	<p><i>Assessment . . .</i></p> <ul style="list-style-type: none"> • occurs through all instructional activities (observations, conferences, responses, logs) • occurs systematically over a period of time • demonstrates progress towards achievement of learning outcomes 	<p><i>Assessment . . .</i></p> <ul style="list-style-type: none"> • focuses on connecting prior and new knowledge (integration of information) • focuses on authentic context and tasks • focuses on application of strategies for constructing meaning in new contexts
4. Collaborative and Reflective Process	5. Multidimensional, Incorporating a Variety of Tasks	6. Developmentally and Culturally Appropriate
<p><i>Assessment . . .</i></p> <ul style="list-style-type: none"> • encourages meaningful student involvement and reflection • involves parents as partners • reaches out to the community • focuses on collaborative review of products and processes to draw conclusions • involves a team approach 	<p><i>Assessment . . .</i></p> <ul style="list-style-type: none"> • uses a variety of authentic tasks, strategies, and tools • is completed for a variety of purposes and audiences • reflects instructional tasks 	<p><i>Assessment . . .</i></p> <ul style="list-style-type: none"> • is suited to students' developmental levels • is sensitive to diverse social, cultural, and linguistic backgrounds • is unbiased
7. Focused on Students' Strengths	8. Based on How Students Learn	9. Offers Clear Performance Targets
<p><i>Assessment . . .</i></p> <ul style="list-style-type: none"> • identifies what students can do and are learning to do • identifies competencies in the development of knowledge, skills, and attitudes • considers preferred learning styles • focuses on celebrations of progress and success • provides for differentiation • provides information to compare a student's performance with his/her other performances 	<p><i>Assessment . . .</i></p> <ul style="list-style-type: none"> • uses sound educational practice based on current learning theory and brain research • fosters development of metacognition • considers multiple intelligences and learning styles • uses collaborative and cooperative strategies • considers research on the role of memory in learning • reflects current models of language learning 	<p><i>Assessment . . .</i></p> <ul style="list-style-type: none"> • encourages student involvement (setting criteria, measuring progress, working towards outcomes and standards) • encourages application beyond the classroom • provides a basis for goal setting • provides students with a sense of achievement • provides information that compares a student's performance to predetermined criteria or standards

Assessment Tools and Strategies

Choosing assessment strategies and tools requires that teachers consider the range of classroom situations that students will experience. A variety of tools and resources may be used.

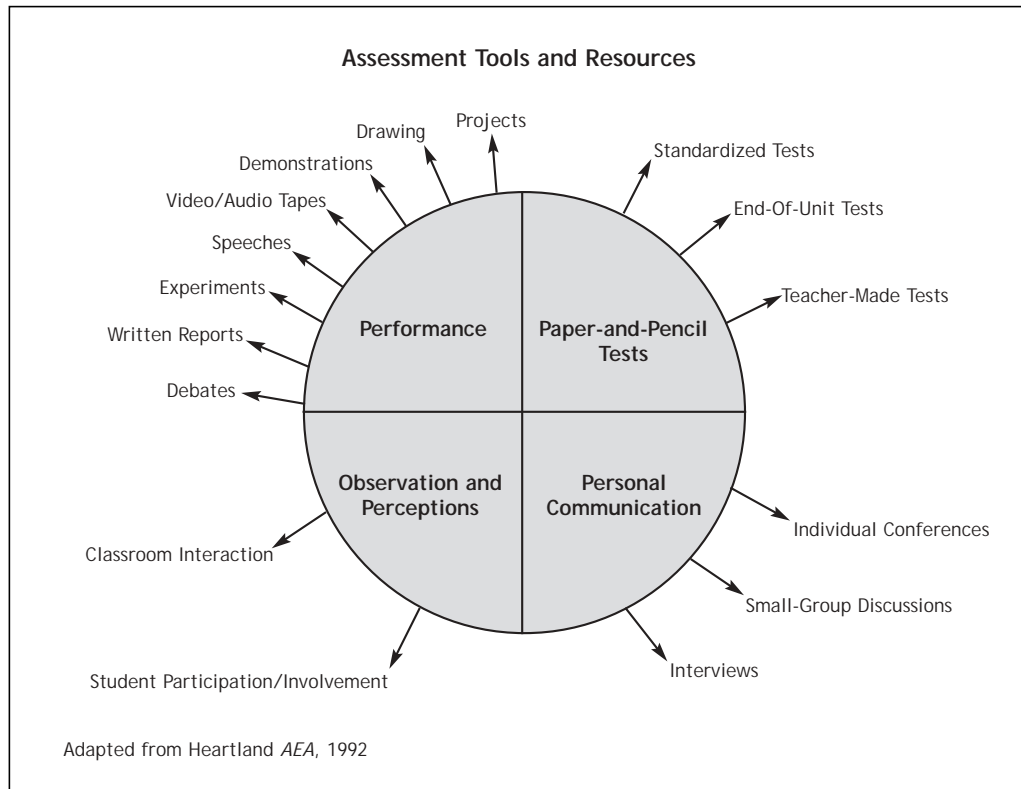

Examples of Student Assessment Techniques

There are a number of ways of organizing student assessment and a variety of tools that can be used to carry it out. The choice of techniques will depend largely on what is being evaluated. Students can be assessed by observing them as they are engaged in classroom activities, by measuring how well their work meets specific criteria, or by giving them different kinds of tests. They can be assessed individually or in groups. The assessment can be done by the teacher, by the student himself or herself, or by other students. A number of different tools can be used to record the results of the assessment, for example, checklists, rating scales, or anecdotal records.

The following are some examples of techniques specifically designed to assess different aspects of second language learning. **Each technique can be used to assess other aspects of learning than the example given.** For example, observation checklists can be used to assess group activities, reflection on learning strategies, the spelling, grammar, and punctuation of written texts, and so on.

Anecdotal Records

Anecdotal records are systematically kept notes of specific observations of student behaviors, skills, and attitudes in the classroom. Anecdotal records provide cumulative information regarding progress, skills acquired, and directions for further instruction. Anecdotal notes are often written as the result of ongoing observations during the lessons but may also be written in response to a product or performance the student has completed. Systematic collection of anecdotal records on a particular student provides excellent information for evaluation of learning patterns and consistency of student progress. Well-kept anecdotal records provide a valuable, practical, and specific reference about a student.

Checklists, Rating Scales, and Rubrics

Checklists, rating scales, and rubrics are assessment tools that state specific criteria that allow teachers and students to make judgments about developing competence. They list specific behaviours, knowledge, skills, attitudes, and strategies for assessment, and offer systematic ways of organizing information about individual students or groups of students.

Checklists usually offer a yes/no format in relation to the specific criteria and may be directed toward observation of an individual, a group, or a whole class. Checklists may be single-use or multiple-use.

Rating scales allow for an indication of the degree or frequency of the behaviours, skills and strategies, or attitudes displayed by the learner. They may be used to gather individual or group information, and are usually single-use. Multiple-use rating scales may be achieved by having students or teacher complete the same rating scale at different times during the school year and making comparisons.

Rubrics are an expanded form of rating scale that list several specific criteria at each level of the scale. They may be used to assess individuals or groups and, as with rating scales, may be compared over time.

The quality of information acquired through the use of checklists, rating scales, and rubrics is highly dependent on the quality of the descriptors chosen for assessment. Their benefit is also dependent on students' direct involvement in the assessment and interpretation of the feedback provided.

Ejemplo de normas de evaluación
Normas de evaluación para la lengua y la cultura españolas

Norma de evaluación para el trabajo cooperativo				
	4	3	2	1
Igualdad en la distribución del trabajo	cantidad de trabajo compartido de manera equiparable	cantidad de trabajo un poco desigual	cantidad de trabajo desigual—hecho en su mayor parte por uno o dos estudiantes	cantidad de trabajo desigual—un estudiante ha hecho todo el trabajo
Se mantiene en la tarea	Todo el tiempo	la mayor parte del tiempo	a veces	poco involucrado(a); rara vez se mantiene en la tarea
Interacción	bastante intercambio de ideas; muestra respeto por los demás	algún intercambio de ideas; respetuoso(a) con los demás	poco intercambio de ideas; se distrae fácilmente; es un poco descortés con los demás	muestra poco interés; es descortés con los demás

Norma de evaluación para presentaciones orales-Respuestas sencillas		
	Sí	No
Pronunciación precisa		
Gramática precisa		

Norma de evaluación para presentaciones orales-Juego de rol cultural				
	4	3	2	1
Pronunciación	precisa todo el tiempo, casi como un hispanohablante	comprensible, con pocos errores	algunos errores, pero se le entiende	pronunciación pobre muy adaptada a su primera lengua (inglés, francés, etc.)
Fluidez	ejecución fluida	bastante fluida	pausas no naturales	insegura; vacilante; intervalos largos
Inteligibilidad	se le entiende fácilmente	se le entiende	se le entiende con dificultad	no se le entiende
Vocabulario	uso amplio del vocabulario meta	algún uso del vocabulario meta	uso mínimo del vocabulario meta	no usa el vocabulario meta
Credibilidad (muestra conocimiento de la cultura)	juego de rol creíble; refleja la cultura	juego de rol creíble; refleja un poco la cultura	poca credibilidad; poca conexión con la cultura meta	no creíble; no hay conexión manifiesta con la cultura meta
Desempeño	animoso, entusiasta; buen contacto visual	entusiasmo general; algún contacto visual	poco entusiasmo; contacto visual limitado	lee de sus fichas; monótono; no hay contacto visual

Adaptado de *Nebraska K-12 Foreign Language Frameworks*

Ejemplo de normas de evaluación
Normas de evaluación para la lengua y la cultura españolas (continuado)

Norma de evaluación para el material escrito-General				
	4	3	2	1
Gramática	perfecta	usa bien la materia que se estudia	algunos errores en la materia que se estudia	parece no entender lo que se estudia
Vocabulario	uso creativo del vocabulario	vocabulario al nivel actual de estudio	algún uso del vocabulario actual; faltan palabras claves	uso mínimo del vocabulario meta al nivel actual de estudio; uso incorrecto de las palabras
Ortografía	perfecta	muy pocos errores en la ortografía y en el uso de la tilde (acento ortográfico)	algunos errores en la ortografía y en el uso de la tilde (acento ortográfico)	muchos errores en la ortografía y en el uso de la tilde (acento ortográfico)

Norma de evaluación para el material escrito-Escritura creativa (estudiantes de 3er. y 4to. Años)			
	Sobresaliente 3	Satisfactorio 2	Deficiente 1
Ortografía/ Pronunciación	ortografía y puntuación casi siempre correctas	algunos errores en todas partes	descuidado; abundantes errores
Gramática	al nivel de estudio o superior con muy pocos errores	algunos errores-no siempre hay concordancia entre sujeto y verbo y/o sujeto y adjetivo, usa a veces tiempos verbales incorrectos; no siempre muestra nivel de estudio actual	la escritura está al nivel del 1er. o 2do. año; muchos errores gramaticales-los sujetos, verbos y adjetivos generalmente no concuerdan; la escritura está en su mayoría en el tiempo presente
Esfuerzo	más del requerido	satisface los requisitos	faltan algunas partes; el trabajo parece hecho a la ligera
Creatividad	descripciones creativas y originales; personajes realistas; bien ilustrado; ordenado	alguna creatividad; descripciones sencillas; en su mayor parte claro y ordenado	no muestra creatividad o planificación; descripciones incompletas; personajes irreales; ilustraciones al azar o no hay ilustraciones

Adaptado de *Nebraska K-12 Foreign Language Frameworks*

Ejemplo de normas de evaluación Escalas de clasificación

Cuadro 7A. Ejemplo de una escala de clasificación inclusiva	
4 — Supera las expectativas	No hay errores en la expresión (p.e. gustos/antipatías y/o preguntar responder preguntas); pronunciación casi como un hispanohablante; uso de las estructuras más allá de la habilidad esperada; usos culturales apropiados casi como de un hispanohablante; siguió instrucciones, excedió lo esperado.
3 — Excelente	Casi todas las expresiones de gustos/antipatías y/o preguntar/responder preguntas son correctas; se le entiende fácilmente con errores poco frecuentes en la pronunciación, las estructuras y en el uso del vocabulario; se demostraron de manera apropiada casi todos los usos culturales; siguió todas las instrucciones.
2 — Bueno	Algunos errores en las expresiones de gustos/antipatías y/o preguntar/responder preguntas; inteligible con errores perceptibles en la pronunciación, las estructuras, y/o en los usos del vocabulario; se demostraron de manera apropiada algunos usos culturales; siguió casi todas las instrucciones.
1 — Todavía no	Pocas o ninguna expresión de gustos/antipatías y/o preguntar/responder preguntas de manera correcta; casi o totalmente ininteligible; los usos culturales fueron impropios o no se demostraron del todo; poca evidencia de seguir instrucciones.

Cuadro 7B. Ejemplo de una escala de clasificación analítica				
	4 Supera las expectativas	3 Excelente	2 Bueno	1 Todavía no
Expresa gustos/ antipatías	sin errores	casi todos expresados correctamente	algunos errores, la mayoría expresados correctamente	pocos o ninguno correctamente expresados
Es inteligible (pronunciación, estructuras, uso de vocabulario)	casi como un hispanohablante; usa estructuras más allá de la destreza esperada	se le entiende fácilmente, errores poco frecuentes	inteligible con errores perceptibles en la pronunciación, las estructuras, y/o en el uso de vocabulario	casi o totalmente ininteligible
Demuestra usos culturales apropiados	usos casi como un hispanohablante	casi todos se demostraron de manera apropiada	algunos demostrados y de manera apropiada	impropios o no demostrados
Sigue instrucciones	excedió lo esperado	sigue todas las instrucciones	sigue casi todas las instrucciones	poca evidencia de seguir instrucciones

Las escalas de clasificación analíticas dan más información sobre criterios específicos y se deben usar cuando los estudiantes y los profesores quieren retroalimentación sobre sus habilidades y debilidades en un desempeño, producto o proceso. Los niveles de desempeño (las normas) se describen para cada uno de los criterios. “Una escala analítica requiere que los evaluadores den por separado evaluaciones de los diferentes aspectos del trabajo. Los criterios que incorporan varios resultados son analíticos”. (Herman, Aschbacher and Winters, p. 70)

Adaptado de *Nebraska K-12 Foreign Language Frameworks*

Ejemplo de norma de evaluación Autoevaluación de la actividad oral

Evalúate en cada una de las siguientes categorías:

- ★★★★★ fantástica
- ★★★★ muy buena
- ★★★ buena
- ★★ regular
- ★ necesita mejorar

	★	★	★	★	★
Contenido					
• El contenido estuvo completo.					
• Las ideas estuvieron bien organizadas.	<input type="checkbox"/>	<input type="checkbox"/>	<input type="checkbox"/>	<input type="checkbox"/>	<input type="checkbox"/>
Inteligibilidad					
• Fui inteligible para mi compañero.					
• Fui inteligible para mi profesor/a.	<input type="checkbox"/>	<input type="checkbox"/>	<input type="checkbox"/>	<input type="checkbox"/>	<input type="checkbox"/>
Vocabulario y expresiones					
• Usé expresiones recién aprendidas.					
• Usé nuevo vocabulario recién aprendido.	<input type="checkbox"/>	<input type="checkbox"/>	<input type="checkbox"/>	<input type="checkbox"/>	<input type="checkbox"/>
Gramática					
• Usé construcciones que son un reto para mí.	<input type="checkbox"/>	<input type="checkbox"/>	<input type="checkbox"/>	<input type="checkbox"/>	<input type="checkbox"/>
Fluidez					
• Hablé una cantidad razonable.					
• Hablé con poca vacilación.	<input type="checkbox"/>	<input type="checkbox"/>	<input type="checkbox"/>	<input type="checkbox"/>	<input type="checkbox"/>
Registro					
• Usé formas de expresión familiares y formales, según el caso.	<input type="checkbox"/>	<input type="checkbox"/>	<input type="checkbox"/>	<input type="checkbox"/>	<input type="checkbox"/>

Desarrollado por Karen Jogan, Albright College, Reading, PA.

Ejemplo de norma de evaluación Evaluación del informe oral

Orador(a): _____

Examinador(a): _____

Fecha: _____ Clase: _____

Título de la tarea: _____

Entendí de qué se trataba el informe. Sí _____ Un poco _____ No _____

Me gustó como el orador/la oradora _____

Para mejorar, el orador/la oradora podría _____

Evalúa el formulario del informe oral de 5 (fantástico) a 1 (necesita mejorar)

Esquemas presentados	5	4	3	2	1
Palabras clave enunciadas	5	4	3	2	1
Organización clara	5	4	3	2	1
Uso de material visual/ilustraciones	5	4	3	2	1
Referencia mínima a apuntes escritos	5	4	3	2	1
Extensión apropiada	5	4	3	2	1
Se respondió a las preguntas	5	4	3	2	1
El orador parece interesado en el tema	5	4	3	2	1
Originalidad, creatividad	5	4	3	2	1
El orador sustenta una opinión	5	4	3	2	1

Desarrollado por Karen Jogan, Albright College, Reading, PA.

Ejemplo de norma de evaluación Evaluación de una historia

Nombre: _____

Fecha: _____

Evalúa la historia:

- ★★★★ fantástica
- ★★★ buena
- ★★ promedio
- ★ necesita mejorar



La historia estuvo bien organizada.

La historia tuvo un comienzo, un desarrollo y un final.

La historia fue interesante y entretenida.

La historia incluyó una variedad de expresiones.

Las ideas en la historia estuvieron claramente expresadas.

La historia pudo ser comprendida por otros.

Me gustó la historia porque _____

Desarrollado por Eliason, Eaton, & Jogan, TESOL, 1997.

Ejemplo de norma de evaluación Para expresar un punto de vista

Nombre: _____	Fecha: _____	Tema: _____
Evalúate en el proceso:		
	muy exitoso	no muy exitoso
Pienso que tuve éxito en expresar mi opinión.	<input type="checkbox"/>	<input type="checkbox"/>
Mi opinión tuvo varios argumentos de apoyo.	<input type="checkbox"/>	<input type="checkbox"/>
Mis argumentos de apoyo estuvieron bien organizados.	<input type="checkbox"/>	<input type="checkbox"/>
Fui persuasivo(a) y convincente.	<input type="checkbox"/>	<input type="checkbox"/>
La estructura de mi oración fue gramaticalmente correcta.	<input type="checkbox"/>	<input type="checkbox"/>
La mejor parte de mi presentación fue _____		

Pude mejorar mi presentación si yo _____		

Desarrollado por Eliason, Eaton, and Joga, TESOL, 1997.

Ejemplo de norma de evaluación
Lista de verificación del relato de una historia: Autoevaluación

Nombre: _____ Fecha: _____

Título del libro: _____ Autor: _____

Por favor marca una "X" en la casilla que describe tu habilidad para hacer lo siguiente:

	Por mi cuenta	Con ayuda de un(a) compañero(a) o de mi profesor(a)	Todavía no puedo hacer esto
Puedo nombrar a los personajes principales.			
Puedo describir la escena.			
Puedo informar sobre los acontecimientos en orden cronológico.			
Puedo identificar los asuntos o problemas principales.			
Puedo describir el desenlace.			
Puedo expresar mis sentimientos sobre la historia y compararlos con otra historia o suceso en mi vida.			
Puedo identificar mi parte favorita de la historia o a mi personaje favorito y decir por qué.			

Desarrollado por Karen Jogan, Albright College, Reading, PA.

Conferences

Conferences provide opportunities for students and the teacher to discuss learning strengths and areas for improvement, and to set learning goals. In conferences, it is possible to learn a great deal about students' understanding of information, attitudes toward learning, and the skills and strategies students employ during the learning process. Conferences provide opportunity for individualized teaching, for guiding students to more challenging materials, and for determining future instructional needs.

Conferences are usually short informal meetings held with individual students, or a small group of students, and involve diagnostic listening, questioning, and responding. Interviews, on the other hand, are conferences that are conducted to gather specific information. They may involve a set of questions you ask for a specific purpose. For example, you may need information about the student's reading patterns and difficulties and may use a formal conference or interview to ask questions directly related to a particular aspect of the student's performance.

Sometimes more formal interviews are conducted regarding student attitudes and metacognitive behaviors. These are often presented as a set of questions or activities to which the student may respond orally with the teacher recording responses.

Whether conferences are informal or formal, they are most beneficial for assessment purposes when they are held on a regular schedule and both student and teacher come prepared with materials to share and questions to ask. Systematic conference notes form a permanent record of the content of the conference and set goals for future learning. Conferences provide opportunities to assess the appropriateness of the tasks and observe other areas of concern.

Once students are familiar with good conferencing procedures, peer conferencing is an alternative for students to obtain feedback and discuss progress and goals.

Continua

Continua or continuums are a series of descriptors that attempt to describe the behaviours that students exhibit as they are developing communicative competence. Teachers can use them systematically to observe and make judgments about students' progress. Although continua are designed to list descriptors according to developmental principles, most students do not develop in a linear fashion. Individual students may exhibit a range of indicators from a number of phases at any one time. Key indicators describe behaviours typical of a phase and provide a way of mapping student progress through the various levels. Students may not move through phases at a regular pace. The indicators do not describe evaluative criteria through which every student is expected to progress in sequential order, but they do provide evidence of an overall developmental pattern.

Performance Assessments

Performance assessment is defined as an assessment activity that requires students to construct a response, create a product, or perform a demonstration. Since performance assessments generally do not yield a single correct answer or method for solution, evaluations of student products or performances are based on judgements guided by criteria (McTighe and Ferrara 34).

Performance assessments are concerned with how students apply the knowledge, skills, strategies, and attitudes that they have learned to new and authentic tasks. Performance tasks are short activities (generally between one and three class periods) that provide an opportunity for students to demonstrate knowledge, skills, and strategies. They are highly structured and require students to complete specific elements. They may be content-specific or interdisciplinary and relate to real-life application of knowledge, skills, and strategies.

Performance assessment tasks can be organized into three categories: products (such as dioramas, slide shows, reports, videotapes, etc.), performances (such as dramatic readings, interviews, debates, etc.), and processes (such as problem solving, cooperative learning, etc.).

Portfolios

F. Leon Paulson defines portfolio as “a purposeful collection of student work that exhibits the student’s efforts, progress, and achievements in one or more areas. The collection must include student participation in selecting the contents, the criteria for judging merit, and evidence of student self-reflection” (60).

The physical structure of a portfolio refers to the actual arrangement of the work samples and can be organized according to chronology, subject, types of student product, or goal area. The conceptual structure refers to the teacher’s goals for student learning. For example, the teacher may have students self-assess a work sample, then self-reflect, and then set a goal for future learning. The work-sample self-assessment and the goal sheet may be added to the portfolio.

Students generally choose the work samples to place in the portfolio. The teacher may also choose to have specific work samples placed in the portfolio.

The charts that follow provide examples of elements that may be included in a second language portfolio, a sample assessment rubric, and ideas for exhibitions and projects.

Carpeta de trabajo del estudiante

Oral Presentations/ *Presentaciones orales*

debates/ *debates*
addresses/ *discursos*
discussions/ *conversaciones*
mock trials/ *simulacros de juicio*
monologues/ *monólogos*
interviews/ *entrevistas*
speeches/ *conferencias*

Visual and Graphic Arts/ *Artes visuales y gráficas*

paintings/ *pinturas*
storybooks/ *libros de cuentos*
drawings/ *dibujos*
murals/ *murales*
posters/ *carteles*
sculptures/ *esculturas*
cartoons/ *historietas*
mobiles/ *móviles*

Performances/ *Representaciones teatrales y artísticas*

role-playing, drama/
juego de roles, dramatización
dance, movement/
danza, movimiento

choral readings/
lecturas en voz alta en grupos

music (choral and instrumental)/
música (coral e instrumental)

Multimedia Presentations/ *Presentaciones audiovisuales*

videotapes/ *videocassetes*
films/ *películas*
audiotapes/ *cintas de casete*
slides/ *diapositivas*
photo essays/ *composiciones con fotos*
print media/ *medios de difusión impresos*
computer programs/ *programas de computación*
storytelling/ *narraciones*
oral histories/ *historias orales*
poetry reading/ *lecturas de poesía*
broadcasts/ *transmisiones*

Representations/ *Representaciones*

maps/ *mapas*
graphs/ *gráficos*
dioramas/ *dioramas*
models/ *representaciones a escala*
mock-ups/ *maquetas*
displays/ *exhibiciones*
bulletin boards/ *tableros de anuncios*
charts/ *diagramas, esquemas*
replicas/ *reproducciones*

Written Presentations/ *Presentaciones escritas*

expressive (diaries, journals, writing logs)/
de expresión (diarios, diarios de registro)
transactional (letters, reports, surveys, essays)/
de transacción (cartas, informes, encuestas, ensayos)
poetic (poems, myths, legends, stories, plays)/
poéticas (poemas, mitos, leyendas, historias, obras de teatro)

Adapted from *Nebraska K-12 Foreign Language Frameworks*, 1996.

Ejemplo de normas de evaluación

Evaluación de la calidad de las carpetas de trabajo

Evaluación de la calidad de las carpetas de trabajo				
Esta norma de evaluación sugiere normas y criterios que los profesores pueden usar para evaluar las carpetas de trabajo. Se deben presentar las normas y criterios a los estudiantes antes de que empiecen a desarrollar sus carpetas de trabajo.				
	Superior	Excelente	Bueno(a)	En desarrollo
Apariencia	visualmente muy atractiva, de apariencia profesional	atractiva, ordenada	un poco atractiva u ordenada	desordenada, no muestra esfuerzo
Creatividad	la creatividad abunda, mucho pensamiento original y/o desarrollo detallado	mucha creatividad, pensamiento original y/o desarrollo detallado	alguna evidencia de creatividad, pensamiento original o desarrollo detallado	poca o no hay evidencia de creatividad, pensamiento original o desarrollo detallado
Contenido	todos los artefactos de calidad elegidos demuestran un nivel de razonamiento alto	los artefactos de calidad elegidos demuestran un razonamiento claro	algunos de los artefactos elegidos demuestran razonamiento claro	pocos o ninguno de los artefactos elegidos demuestran razonamiento claro
Organización	organización impresionante que hace que la lectura fluya de manera continua	organizada, transición clara entre los trabajos y las partes de la carpeta	bastante organizada, buena transición entre los temas	nada en orden, parece juntado casualmente, no hay transición
Integridad	tiene las muestras obligatorias, demuestra mucho esfuerzo suplementario con muestras adicionales	tiene la muestra obligatoria, algunas muestras adicionales	tiene las muestras obligatorias	faltan algunas muestras obligatorias
Reflexión	alto nivel de pensamiento analítico respaldado con evidencia sólida	tiempo evidente en reflexionar, honesta; detalles excelentes	muestra reflexión adecuada	muy breve, hecha con apuro, no sincera u honesta

Adaptado de *Nebraska K-12 Foreign Language Frameworks*, 1996.

Ideas for Exhibitions and Projects

The following list provides teachers with ideas for products, performances, and processes that can be incorporated as authentic tasks into projects and exhibitions. Teachers using this list will provide students with meaningful, relevant classroom experiences that can be applied in real-world contexts and actively involve students in the learning process.

The list was compiled from a variety of sources (Jacobs, 1995; Maker & Nielsen, 1996); most are ideas from teachers who have used them in the classroom.

World language teachers are encouraged to use this list to create their own list of projects to fit course outcomes and the varied interests and talents of students.

The categories are only one way to arrange the list. Many products and performances can cross over into other categories. In the world language classroom, culture is interwoven throughout the products, processes, and performances, as are the communicative skills.

Media/Technology

advertisements	editorials	news reports	slides
cable channels	filmstrips	newsletters	slide shows
CD-ROM creations	infomercials	newspapers	TV shows
clip art	magazines	opinion polls	TV Guide
commercials	marketing campaigns	radio shows	travelogue
computer graphics	movies	screenplays	videos
computer programs	multimedia presentations	scripts	Web home pages

Visual and Performing Arts

artwork:	dances	music compositions	puppets/shows
• painting	displays	musical instruments	raps, jingle, chants
• sculpture	drawings	musical performance	cheers
• ceramics	flags	musical plays	record/CD/book covers
banners	flip books	musical symbols	role plays
billboards	flower arrangements	origami	silkscreen prints
block prints	fugues	pantomimes	simulations
bulletin boards	greeting cards	paper	skits
cartoons	illustrations	papier-mâché creations	sociodramas
choral readings	jewelry	photo essays	song writing
chorales	labels	photography	stitchery
clay models	logos	plays	tattoos
clothing design	masks	pop-up books	totem poles
collages	mobiles	posters	wallpaper patterns
comic strips	mosaics	pottery	
costume creation	murals	props for plays	

Speaking/Listening

audio/videotapes	debates	oral reports	seminars
choral readings	discussions	panel discussions	speeches
court-trial simulations	flannel boards	presentations	story boards
cooperative tasks	narratives	scenarios	

Adapted from *Nebraska K-12 Foreign Language Frameworks*, 1996.

Ideas for Exhibitions and Projects (continued)

Reading/Writing/Literature

3-D research papers	expository writing	myths	research reports
ABC books	fables	narrative writing	satires
bibliographies	historical documents	outlines	stories
biographies	histories	persuasive writing	term papers
bookmarks	illuminated manuscripts	poetry	time capsules
books	journal articles	poetry anthologies	time-lines
children's stories	lists of books read	portfolios	written questions
dictionaries of terms	lists of movies seen	position papers	writing systems
encyclopedias	lyrics	reaction papers	
essays	memoirs	reports	

Hands-on/Kinesthetic

collections	floor plans	obstacle courses	synchronized movement
constructions	flower arrangements	physical exercise	terrariums
crafts	games	precision drill team	tools
demonstrations	inventions	project cube	treasure hunts
dioramas	labs	scale models	
environmental studies	learning centres	scavenger hunts	
field trips	models	sewing	
flash cards	museum displays	sports/outdoor activities	

Daily Life

application forms	email	letters of all kinds	receipts
bills	eulogies	manuals	recipe books
boxes/cartons	family trees	maps	recipes
brochures	foods/cooking	menus	resumés
checks	government forms	messages, voice/written	schedules
cleaning	instructions	obituaries	school
contracts	invitations	pamphlets	scrapbooks
customs	journals	parties	shopping lists
daily routines	junk mail	petitions	spreadsheets
diaries	labels	photo albums	surveys
directions	last wills	prescriptions	work
	laws	questionnaires	

Thinking Skills

analogies	crossword puzzles	graphic organizers	secret codes
categorizing/classifying	decision making	graphs	self-discovery
cause/effect	design experiments	graphs, 3-D	synthesis
charts	diagrams	homework	synthesis of research
compare/contrast	elaboration	lessons and test design	tessellation
comparison charts	evaluation	patterns	Venn diagrams
concepts	evaluation of evidence	plans	visualization
cross-number puzzles	experiments	problem solving	webbing/mind maps
	extrapolation	puzzles	
	fact files	rating scales	
	goal setting	reflection	

Adapted from *Nebraska K-12 Foreign Language Frameworks*, 1996.

Cloze

In cloze procedure, words or parts of words are masked or blocked out in a sentence or a short passage. Students must use other cues or clues in context, both in the text and from their background experience, to replace or complete the missing words. As students read and come to the blank in the sentence, they call on cueing systems and other sources of information to help decide what word would make sense in the sentence. With young students, perhaps only one word in the sentence would be left out. With older students, as many as eight to ten deletions in a passage would be appropriate. Experience with cloze passages encourages students to maximize their use of the cueing systems. Students choose which information sources and strategies are most appropriate when meeting unknown words, rather than overusing graphophonic clues and sounding out words without any reference to meaning or word order.

Think-Alouds

Think-Alouds involve asking students to verbalize their thought aloud while engaged in a task. Think-Alouds are an effective instructional strategy, can provide insight into how readers process text, and serve as a very effective assessment strategy for written interpretation and use of strategies.

PLANNING FOR INSTRUCTION AND ASSESSMENT

Why Plan?	3
General Information on Planning for Spanish Teachers	6
Task-based or Project-based Language Learning	11
Unit Planning	15
Planning Tools	17
Sample Plans	33
Year 1: Family and Celebrations	35
Year 3: Cultural Diversity in the Spanish-Speaking World	55
Year 6: Current Issues	75

PLANNING FOR INSTRUCTION AND ASSESSMENT

Why Plan?

- Creating a plan increases teacher awareness of curriculum outcomes and student needs, and enhances teaching practices.
- Teachers are more likely to effectively meet the expectations of the curriculum, school, students, and parents.
- Topics can be sequenced in a logical way, providing important linking for students.
- Planning well gives teachers confidence. It enables the teacher to anticipate and be prepared for meeting individual student needs and alternative situations that arise in the classroom.
- Planning well reduces many management problems in the classroom.
- Advance planning helps teachers to access resources, and it reduces stress and increases effectiveness.
- Planning well ensures a sound rationale is evident and ready for presentation to parents, students, and administrators.
- Collaborative planning allows teachers to engage in professional dialogue about curriculum, successful practices, individual student needs, and effective use of resources.

Developing Plans

In developing plans, teachers need to effectively

- select an approach to planning
- read and understand the general and specific outcomes provided in the Spanish Language and Culture curriculum
- consider student needs, background knowledge, and experience
- select the appropriate outcomes and the sequence in which they will receive focus
- select teaching and learning activities
- select learning resources
- consider assessment and evaluation

Outcomes

Outcomes in Spanish Language and Culture assist classroom teachers and other educators to

- plan learning activities that support Spanish language growth and student achievement in Spanish Language and Culture
- establish goals for learning, instruction, and assessment in Spanish Language and Culture
- monitor student progress in achieving outcomes in Spanish Language and Culture
- communicate with students, parents, and guardians about student progress in Spanish Language and Culture
- select appropriate resources to support student learning

Planning with Outcomes

The outcomes separate the four components of communicative competence: language competence and applications, intercultural competence (Global Citizenship), and strategic competence. When planning, teachers need to reflect on how these components can be integrated through activities that involve meaningful communication. Planning needs to include a careful analysis of the outcome statement to determine appropriate instructional materials. The following example shows how the four components are integrated in one learning activity.

Consider an activity where a student is asked to prepare a classroom presentation and a poster summarizing the information gathered on an aspect of the culture of a specific Spanish-speaking nation that he or she finds appealing. The guidelines for the activity are as follows:

- Brainstorm potential themes or topics for the exercise and select one. (Applications/Strategies/Global Citizenship)
- Use a concept map to detail what information is required, and develop a plan for gathering the information. (Strategies)
- Identify key vocabulary or terms related to the theme or area of interest. (Language Competence/Lexicon)
- Undertake research, drawing on at least four web-based and print-based Spanish resources and summarize information gathered. (Language Competence/Global Citizenship)
- Prepare presentation and poster using visuals to aid in communicating your ideas. (Language Competence/Applications)
- Check and edit your presentation to ensure correct spelling and grammatical structures. (Language Competence)
- Present to classroom. (Language Competence/Applications)

- Reflect on the experience and identify what you learned, how you learned it, what gaps in learning you perceived, and what was most challenging. (Strategies)

Selecting Outcomes

Selecting outcomes is the critical component in developing unit or lesson plans. Which aspects of language learning do you want to focus on? Where are your students in their development of their linguistic and cultural skills?

In targeting outcomes for unit or lesson planning, teachers also need to consider how they relate to one another. Once outcomes are identified the next step is to consider which learning activities or tasks lend themselves to the development of the outcomes.

Considering Assessment and Evaluation

Planning for assessment is an essential aspect of unit and lesson planning. It is important that teachers consider what information they need to collect and what is directly related to the outcomes. How will students demonstrate these outcomes in the context of the learning tasks and activities selected?

Finally, it is important to select the type of assessment tools best suited for the assessment focus. See *Classroom Assessment*, page 9.

Selecting Resources

Planning lessons and assembling resources for a language course means more than finding a good text with accompanying workbook and listening tapes. As much as possible, students should work with all kinds of resources. Authentic documents, that is, documents that were designed for Spanish speakers rather than for the purpose of second language teaching, are particularly interesting. By using authentic documents, students gain experience in finding, exploring, and interpreting different kinds of texts, and have models for producing texts of their own.

By using a variety of resources rather than a single text, teachers can better accommodate the diverse learning needs of students found in the average classroom. Even though all students in the class are working on the same task, they may be using different resources depending on their preferred learning styles, level of proficiency, or cognitive development.

Approaches to Planning

There are several approaches to planning for instruction. These may be categorized as thematic, integrated, content/subject based, and task-based approaches. These are not mutually exclusive and often elements of each will be used by teachers to plan for instruction.

Thematic approaches focus on a specific topic or central idea which forms the basis for the unit or the lesson being planned. The theme chosen serves as the organizer for the instructional activities. Themes may be broad or may be specific in nature (e.g., Music of Chile versus the Meaning of the Macarena song). School-based themes provide an opportunity for cross-subject and classroom collaboration.

Integrated approaches are closely related to thematic approaches. They focus on choosing themes that allow for connections with various subject areas or for drawing on a broad range of skills and concepts. Integrated units allow for collaboration between subject area teachers. Students may value integrated learning experiences because they are more “real-life” in nature and relate to other school subjects.

Task-based approaches focus on the engagement of students in very meaningful tasks rather than elements of language. Generally, in task-based approaches, learning tasks have a clear beginning and end.

Regardless of the approach or combination of approaches one may prefer, all of them may be applied to the development of yearly, unit, or lesson plans. These are described in the following section.

General Information on Planning for Spanish Teachers

Types of Plans

Yearly Plans

In creating a long-range plan, a teacher looks at students and elements of curriculum, and considers the school’s goals and the year ahead. On this basis, the teacher makes a tentative sequencing of classroom instruction units that would be effective.

Unit Plans

To develop a unit plan, a teacher looks at the students and their needs, and organizes strategies and selects specific learning activities which are aligned with several identified curricular objectives or student outcomes.

Lesson Plans

Lesson plans ‘map out’ in detail instructional and learning activities in support of one or more outcomes. Usually lesson plans refer to daily plans.

Planning for Balance

Planning for a balanced Spanish Language and Culture program needs to take the following into account:

- Specific outcomes stated are end-of-year outcomes; while students may reach the level of competence described by the outcomes at any time during the year, the outcomes describe end-of-year performance. Educators must consider the series of instructional steps that will lead to accomplishment of the outcomes by the end of the year.
- Learning is recursive and integrative. Many of the outcomes need to be addressed repeatedly in different ways throughout the school year. Students need practice in many meaningful contexts to consolidate new knowledge, skills, and strategies. As well as developing new literacy skills and strategies, students need to review, maintain, and refine those learned previously.
- Planning is continual and informed by needs that become evident through classroom assessment.
- A variety of instructional approaches, classroom management techniques, assessment practices, tools and strategies, and language arts learning experiences are essential.
- Students may be taught in a variety of organizational structures, including multi-graded classrooms.

Developing a balanced, integrated Spanish program is a creative process. Instruction is shaped by the teaching style, resources, and strengths of each teacher, by the interests, abilities, and talents that each new group of students brings to the classroom, and by the needs of the community.

Some areas of balance to consider in planning include the following:

- four general outcomes
- three modes of communication: productive, interpretive, and interactive
- text types: oral, written, and multimedia texts (which include a variety of expository or informational, narrative, poetic, and dramatic texts; and a variety of forms and genres such as videos, magazines, letters, charts, and computer programs)

- various functions: imparting and receiving information; expressing emotions and personal perspectives; getting things done; extending knowledge of the world; forming, maintaining, and changing interpersonal relationships; and for imaginative purposes and personal enjoyment
- grouping patterns: individual, pairs, small groups, large groups, whole class, heterogeneous, homogeneous, student-directed, teacher-directed
- various levels of language proficiency and the language background and experiences of the student
- various learning styles and multiple intelligences
- various rates of student learning, addressed by providing pre-teaching, review, and additional practice for some students, and challenging extension activities for others

Planning for balance while ensuring sufficient instruction and practice in all the outcomes defined for a particular grade or course is a challenging task. Choosing particular ideas and strategies precludes using others. It is unlikely that a teacher would use all the suggestions for instruction and assessment for a specific outcome with a particular grade. For example, various types of journals and logs are discussed: personal journals, reader response journals, learning logs, and writers' notebooks. Students likely would not maintain all of these simultaneously.

Yearly Planning

Long-range planning is making difficult decisions about the direction of our programming based on our best professional judgment. Long-range planning is problem solving. Long range plans are often viewed as a finished product rather than a working document and as a "means to an end." If planning is to be effective and of value to the teacher, risk taking, continual monitoring, and subsequent modifications are valued parts of the process. A real year plan will reflect changes and will be a working document, not a polished masterpiece.

To begin long range planning:

- Know and use the curriculum.
- Focus on how the planning will help you and your students, not on the product or what someone else might expect.
- Look at the different types of long-range planning and consider those which best meet your needs.
- Remember that there is no one right way to plan.

There are many types of long-range plans. Teacher should choose a style that meets their needs and the needs of the specific instruction groups.

Thematic Planning

Traditionally, thematic planning has been considered the domain of primary teachers although it has been widely used in gifted education. Varieties of thematic planning are now in many settings from early education onwards.

Thematic planning has proven especially helpful to teachers of multi-age and combined class groupings. Where teachers plan for a wide range of abilities, thematic teaching allows all students to build knowledge, skills, and attitudes—experiencing success at their own level within a collaborative whole-class environment.

Thematic planning also is chosen by teachers who tend to look at the global picture, rather than seeing discrete, sequenced units. It may also be preferred by teachers who like to work collaboratively with other teachers or draw on the concepts and experiences which students are being exposed to in other settings. Although there are many approaches to thematic planning, basically thematic teaching differs from subject-based planning in that priority curricular expectations are linked and/or clustered deliberately across subject areas. Thematic teaching often takes place in larger blocks of time created by merging periods of time apportioned to each subject area.

In another thematic approach, teachers pick up a **common thread** within several subject areas.

Teachers may **sequence** topics or units of study to coincide with one another. Similar ideas are taught together at the same time.

Some teachers base their year around large issues or questions that **encompass** all or almost all areas of curriculum. This planning requires in-depth knowledge of curricula and a willingness to create or modify existing resources.

Benefits of Thematic Planning

Recent **brain research** tells us that learning is enhanced when inter-related areas are linked. To maintain and extend memory networks, students need to test their memories in stimulating and meaningful contexts. Both the relevance of the material to the learner and the emotional involvement of the learner are important components in effective learning. By choosing themes that are relevant and of interest to students in the classroom, thematic planning links and builds knowledge in a “brain-friendly” way.

Motivation is important in learning. In well-conceived thematic instruction, successful experiences are fostered for a wide range of students and differing expectations become the norm. Thematic planning allows for more extensive and intensive exploration of a specific area of interest or study. This helps students build enthusiasm and become more reflective and involved in their own learning.

The thematic approach allows a wide range of students to experience success and **achievement** at their own levels. Disadvantaged students link with their background knowledge and read materials on the theme at their own level, enhancing achievement. Gifted learners move beyond a core of basic learning experiences. Thematic units that allow for more in-depth explorations and learning allow students to process more and become more active learners. Authentic assessments tend to be utilized within the thematic approach, allowing more students to demonstrate their success.

Effective instructional techniques are fostered within the thematic structures. Teachers gain enthusiasm by learning along with students—acting as role models of continuous learning and problem solving. Important changes may occur in classroom dynamics as teacher and students use the word *we* more than *I*. With instruction that is less fractured, many teachers enjoy the flow of thematic teaching and experience a **feeling of success** in reaching more students.

Helpful Hints for Thematic Planning

- Choose themes and/or topics that are guided by the outcomes you wish to develop. These should be the focus of the planning.
- Carefully select themes that are appropriate for the age and interests of students and complement the areas of experience recommended.
- Try, where you can, to choose broad rather than narrow thematic topics or open up topics through the use of ambiguous titles. Check the area of experience for each grade level to guide your selection of unit and lesson plans.
- Start with a manageable project in thematic planning and build from there. It's all right to start your year with a theme, and then focus on specific tasks or areas of language development!
- Communicate learning goals for the year and your thematic plans to parents and students. Chart your thematic year plan for Open House at the beginning of the year.
- Ensure that parents see curricular expectations specifically on student assignments, displays, evaluations, and portfolio samples throughout the year to reassure them. Regular newsletters previewing upcoming themes and activities add to parental buy-in.

- Remember that a year plan is a working document that will be periodically reviewed and revised.
- Teachers may choose to teach thematically, but continue routine task-based learning activities such as dialogues, role-playing, learning journals, etc.

Long-Range Planning Review

- Choose a style of planning that suits your needs: subject-based, thematic (integrated), strategic, or a combination of several.
- Select priority expectations from the curriculum based on your knowledge of your students, and highlight these on curricular checklists.
- Develop a year plan that logically flows and develops priority curricular expectations.
- Remember that a year plan is a working document that will be periodically reviewed and revised.
- Focus on what the students will learn, not just the activities they will engage in.

Task-based or Project-based Language Learning

A task-based approach to learning Spanish is designed to have students develop language competence and communicative skills by doing things rather than by simply studying the language. The students no longer begin by learning the form or grammar of the language. Instead, they find themselves in a situation where they must use the language for a definite purpose, to complete a clearly defined task or project. The task is defined at the outset and creates the need to know certain elements of the language, thus giving meaning and context to all language activities.

All content, activities, and evaluation in the unit grow out of the task. Specific language content is determined once the task has been identified. Explicit teaching of grammar rules, exercises which concentrate on form, and practice of specific strategies all have their place in the classroom, but they will be done as a result of the students' need to know elements of the Spanish language in order to accomplish the task more effectively. The task provides an organizational framework within which all skills, knowledge, and attitudes are developed.

Choosing a Task or Project

The choice of tasks will be based on the interests of students while at the same time covering as broad a range of areas of experience as possible. It is important that the task be flexible enough to allow for some differentiation. In this way, students with different levels of proficiency, different interests, and different backgrounds can work together and learn from one another.

Good projects or tasks should

- match the interests of the students
- require students to focus on meaning and purpose
- draw objectives from the communicative needs of students
- involve language use in carrying out the task
- provide opportunities for language practice
- allow for flexible approaches to the task, offering different routes, media, modes of participation, procedures
- allow for different solutions, depending on the skills and strategies drawn on by students
- be challenging, but not threatening
- require input from all students in terms of knowledge, skills, and participation
- promote sharing of information and expertise
- allow for co-evaluation by the student and the teacher of the task and of the performance of the task
- provide opportunities for students to talk about communication (metacommunication) and about learning (metacognition)
- provide for monitoring and feedback
- be effective and efficient (i.e., the effort to master aspects of the language should “pay off” in terms of communicative competence, or cognitive and affective development of the learner)

The order in which the tasks are undertaken is usually decided based on their level of difficulty, which depends on a number of factors:

- the characteristics of the learner
- the amount of contextual support provided to the learner
- the cognitive difficulty of the task
- the amount of assistance provided to the learner
- the complexity of the language which the learner is required to use
- the amount and type of background knowledge required

Some of these factors are variable (e.g., the amount of support provided), while others are not (e.g., characteristics of the learner).

In the following table, some of the factors which determine the relative difficulty of a task are outlined. By examining a task in relation to these factors, a task that is appropriate for the students can be chosen.

less difficult		→	more difficult	
cognitive complexity	describing		sequencing	
	classifying		identifying principles	
listening	one speaker	two speakers	three speakers	four or more speakers
	familiar topic		unfamiliar topic	
speaking	taking short turns		taking long turns	
	familiar, sympathetic conversation partner		unfamiliar, uninvolved individual or group	
	familiar topic, well-organized memory		new topic or experience, not well organized	
text type	description	instructions	storytelling	providing and justifying opinions
	few elements, properties, relationships, characters, factors		many elements, properties, relationships, characters, factors	
	ample contextual support (titles and subtitles, pictures or diagrams, etc.)		little contextual support	
language	simple		complex	
	less interpretation required (information is explicit)		more interpretation required (information is implicit)	
	more redundant (information is repeated in different ways)		more dense (information is given only once)	
task type	one-way transfer of information		two-way exchange of information	
	convergent		divergent	
	concrete, "here and now"		abstract, different time or place	
support	more		less	

Sometimes a task may, at first, appear too difficult for the students, but if it is of great interest to them, it can be sometimes be undertaken by adjusting some of the above variables to make it less difficult. In the same way, the same task can also be made more or less difficult for different groups of students in mixed-level classes.

The table below provides some ideas for tasks that students could undertake at this level. Students can be expected to complete between five and eight of the more complex tasks in the course. Some tasks could be the focus of a unit of study which could take from 15 to 20 hours to complete. See the next section for more information on unit planning.

Global Task List		
Make a/an	Learn a/an	Do a/an
list booklet big book pamphlet or brochure dictionary recipe book guide picture album poster mural collage model class display crest map calendar greeting card menu family tree cover (book, CD, video) game board advertisement comic strip puppet classified ad	game sport song dance poem story nursery rhyme craft (then make up a new one)	survey research project simulation role play interview demonstration debate biography critique
	Keep a log of	Plan a/an
	books read TV programs watched weather travel	trip self-improvement project exchange immersion weekend excursion meal celebration guest speaker visit
	Present a/an	
	fashion show puppet show play dance concert	
Solve a problem	Write and send a/an	
jigsaw task information gap cloze activity grammar dictation science experiment math problem make a decision	personal letter greeting card email message letter to the editor business letter invitation	

Unit Planning

Unit planning when using a task-based approach to second language learning is a little different than planning for a more traditional language-based approach. Instead of beginning with the linguistic content (vocabulary, grammar, functions), you begin with a theme or topic and a task. The language content grows out of the task and the resources used for the task. The following steps provide a list of considerations for unit planning:

1. Choose a theme or a topic which is of interest to the students, which offers possibilities for developing the students' communicative competence in Spanish, and which allows for some general learning as well. Students can participate in this step of the planning process.
2. Decide on a unit task that is appropriate to the theme, is of interest to the students, and is within their capabilities, both from a cognitive and a language point of view. Students can participate in this step as well. This task becomes the main element around which the unit is organized. The unit task will most often take the form of a project that can be worked on over a period of several weeks. See the Global Task List on the preceding page for suggestions.
3. Look for resources which might be useful in preparing students to carry out the task. Resources should be attractive and rich in visual supports such as charts, pictures, diagrams, etc. Once the resources have been found, analyze them for elements that might need to be introduced, for example, a particular accent in an audio text, a cultural reference, strategies needed to deal with an authentic document, idiomatic expressions, and so on.
4. Analyze the task to determine what the students will need to know and to learn in order to be able to carry out the task. Think about the product the students will produce (the project or task), but also about the process they will go through in producing the product (e.g., working in groups, doing research, interviewing people). Think about language functions, vocabulary, grammar, text types, historical and contemporary elements of the culture, strategies, general knowledge, and so on. Think about the resources you have found for the unit.

5. Outline a series of steps or mini-tasks directly related to the unit task to help the students learn and practise the language they will need to carry out that task. Some of these mini-tasks might focus on particular language functions (applications), building vocabulary around the theme or topic, learning and practising specific grammatical structures, analyzing the characteristics of a particular text type, developing a cultural element, working on a learning strategy, and so on.
 - It is a very good idea to begin a unit with an activity that stimulates the students' interest in the topic, and helps them make connections between what they already know about the topic and what they will be learning. This introductory activity also starts to establish the linguistic base necessary for the rest of the unit, although it should not include the formal teaching of a pre-determined list of vocabulary. Vocabulary for the unit is better taught as the need arises throughout the whole unit.
 - It is also very helpful to end the unit with an activity that leads students to reflect on the unit. This can include discussion about what they learned, the strategies they used, and how their attitudes may have changed. It can also include planning for future units based on perceived gaps in their knowledge and skills. This step is important for developing metacognitive strategies and independent learning.
6. Determine the specific objectives for the unit, keeping in mind all four components (applications, language competence, global citizenship, and strategies).
7. Think about aspects of the unit that could be adapted to accommodate the needs, interests, and aptitudes of different students. Be prepared to be as flexible as possible without compromising the objectives of the unit.
8. Plan student assessment and evaluation. Integrate assessment throughout the unit.

Although unit planning is presented above as a series of steps, for most people, it will involve going back and forth between steps, rather than progressing straight through from step 1 to 8. Some of the planning will take place beforehand, and some as the unit progresses.

PLANNING TOOLS

Areas of Experience

See Appendix D for a list of appropriate areas of experience.

Grammatical Elements

For lists of grammatical elements, see Outcome 2.1.4 on pages Year 1–30 to 32, Year 2–26 to 30, Year 3–28 to 32, Year 4–30 to 34, Year 5–28 to 32, and Year 6–28 to 32.

Learning Resources

In planning yearly unit and lesson plans, teachers will find it helpful to refer to the annotated bibliography of Spanish learning resources. The annotated bibliography may be found online at the Manitoba Education, Citizenship and Youth website at

<http://www.edu.gov.mb.ca/ks4/learnres/spanish/sp7-s4com2000-2003.pdf>.

Planning Your Year					
Grade Level(s): _____ School Year: _____ Teacher(s): _____					
	September	October	November	December	January
Unit(s)					
Outcomes					
Instructional Approaches and Learning Activities					
Resources					
Assessment and Evaluation					

Planning Your Year					
Grade Level(s): _____ School Year: _____ Teacher(s): _____					
	February	March	April	May	June
Unit(s)					
Outcomes					
Instructional Approaches and Learning Activities					
Resources					
Assessment and Evaluation					

Unit Components

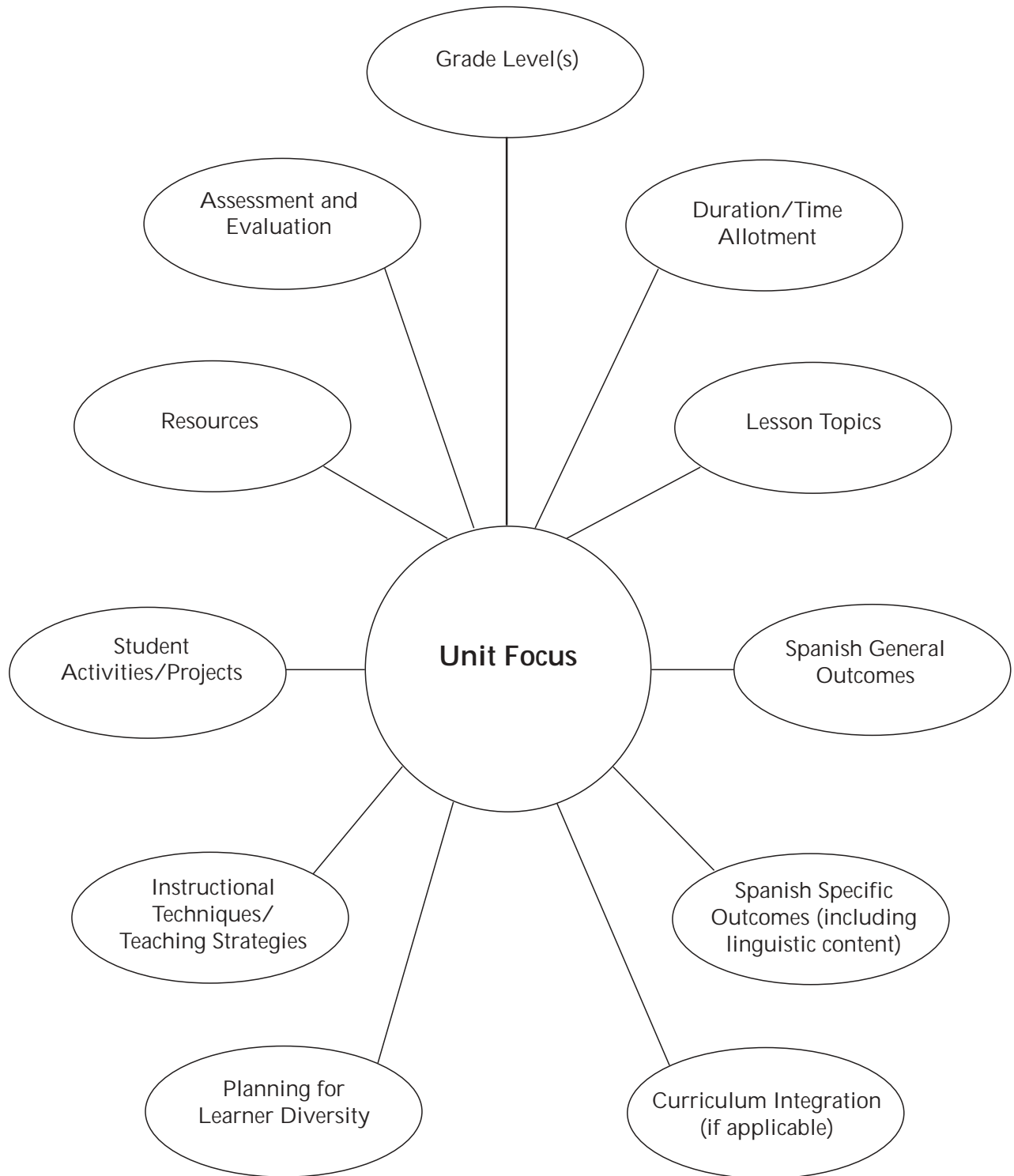

Unit Components

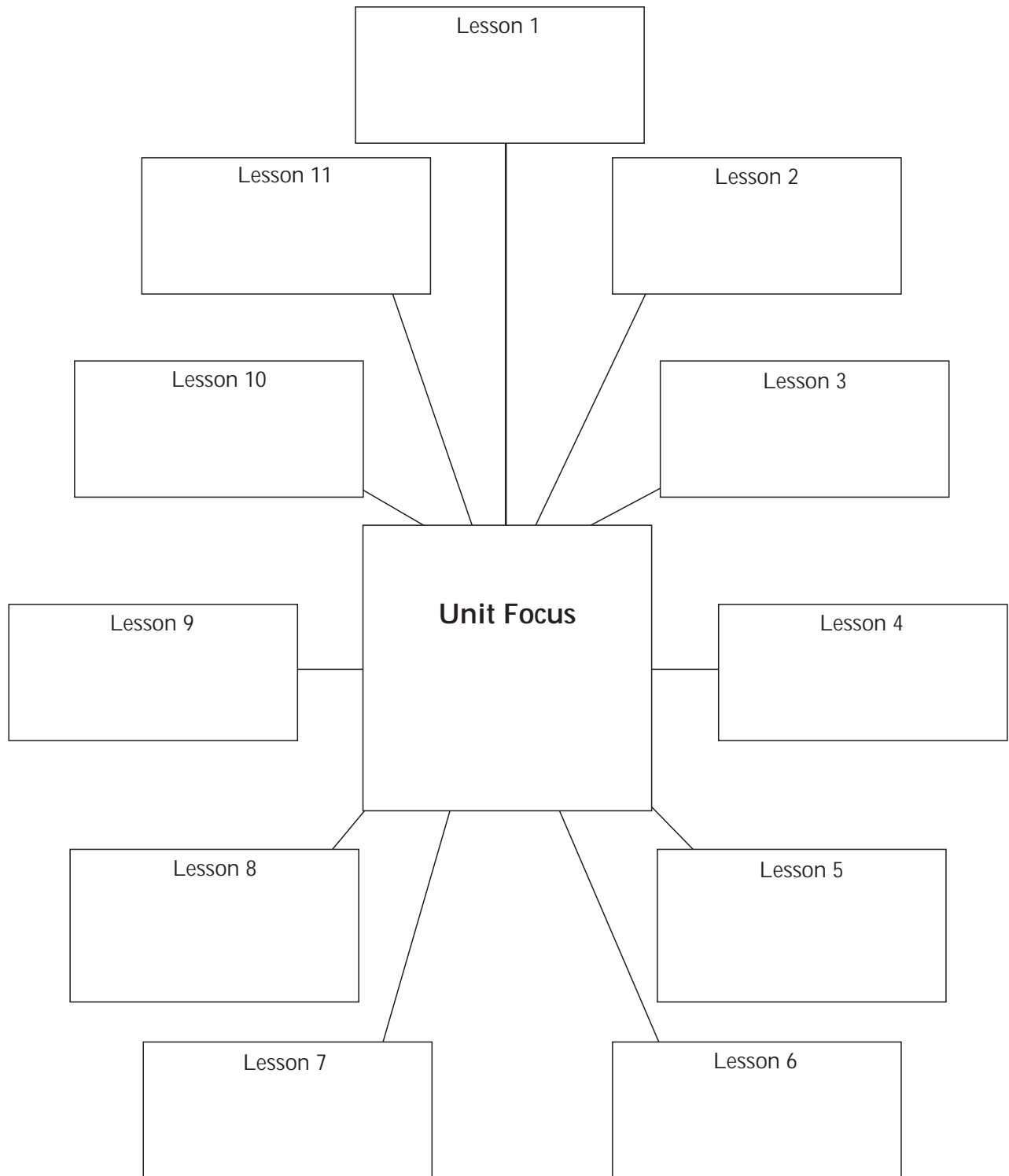

Unit Plan:							
Day/ Sequence	Lesson Topics	Outcomes	Instructional Strategies and Learning Activities	Major Resources	Assessment/ Evaluation	Planning for Diversity of Learners	
Day 1							
Day 2							
Day 3							
Day 4							

Unit Plan Outline	
Unit Focus:	Grade Level(s):
Duration/Time Allotment	
Lesson Topics	
Spanish Language and Culture Outcomes	
<ul style="list-style-type: none"> ✦ General Outcomes ✦ Specific Outcomes (including linguistic content) 	
Curriculum Integration (if applicable)	
Planning for Learner Diversity	
Instructional Strategies/ Teaching Techniques	
Student Activities/Projects	
Resources	
Assessment and Evaluation	

Integrated Unit Plan Overview		
Unit Focus: _____ Grade Level(s): _____ Teacher(s): _____		
<p style="text-align: center;">Spanish Language and Culture</p> <p>General Outcomes:</p> <p>Specific Outcomes:</p>	<p style="text-align: center;">_____ Subject Area</p> <p>Outcomes:</p>	
<p>Instructional Strategies and Learning Activities</p>		
Planning for Diversity of Learners	Resources	Assessment and Evaluation

Unit Planning Checklist

- Have you selected the outcomes you wish to focus on in this unit?
- Have you considered student needs, interests, and abilities and incorporated students' input?
 - Have you considered the relevance of this unit to
 - students' lives outside of the school context?
 - students' language and learning experiences in other subjects?
 - students' continued language development?
- Can you identify the outcomes related to language competence and applications that students will attain?
- Have you incorporated appropriate global citizenship outcomes into the unit?
- Can you identify the historical and contemporary elements of the Spanish-speaking cultures present in the language competence content of the unit?
- Can you provide a rationale for the unit?
- Have you selected interesting, useful, and varied resources to accompany the unit?
- Have you included a variety of instructional strategies, language experiences, and activities?
- Have you provided opportunities for students to apply listening, speaking, reading, and writing skills in different contexts?
- Does the unit plan allow for flexibility and adaptation?
- Have you provided opportunities for student input and collaborative decision-making?
- Have you determined appropriate assessment and evaluation techniques?
- Have you considered possible unit extensions and applications?

Lesson Plan Format

Subject(s): _____

Lesson plan made by: _____ Grade: _____ School: _____ Date: _____

Learner Outcomes:

Planning for diversity of learners:	Prerequisite knowledge, skills, strategies, and attitudes:
-------------------------------------	--

Organization decisions to achieve the outcomes:

	Time	Learning Activities	Instructional Strategies	Resources
Introduction				
Sequence of activities in main body of lesson				
Conclusion				

Assessment and Evaluation

Lesson Plans

Outcomes:

Planning for Diversity:

Resources:

Method:

Assessment/Evaluation:

Long-Range Plans

Grade Level(s): _____ School Year: _____ Teacher: _____

Unit Focus:

Duration:

Unit Description:

Outcomes:

Unit Focus:

Duration:

Unit Description:

Outcomes:

Unit Focus:

Duration:

Unit Description:

Outcomes:

Unit Focus:

Duration:

Unit Description:

Outcomes:

SAMPLE PLANS

Year 1: Sample Unit

Family and Celebrations

Sample Unit on the Family and Family Celebrations

Topic/Theme: La familia y las celebraciones de la familia	
Grade Level: Year 1 (beginner)	Task: Make and present a family tree (student's own family or a fictional family). Alternate Tasks: Research and present a famous family. Make and show a PowerPoint presentation using family pictures.
<p>Analysis of language needs to complete task:</p> <p>Product: la familia (padre, madre, abuelo, abuela, hermano, hermana, etc.): Structures for asking questions: ¿Quién (es)? ¿Qué? ¿Cómo? ¿Cuál(es)? ¿Cuándo? Examples: ¿Tienes un hermano? –Sí ¿Quién es? –Es mi tío. ¿Cómo se llama tu tío? –Mi tío se llama Andrew. ¿Cuándo nació tu padre? –Mi padre nació el cinco de julio. Dates: el treinta de agosto, el cuatro de marzo. Names of common family celebrations: el cumpleaños, la boda. Vocabulary for talking about celebrations: celebrar, romper la piñata, comer. Possessive adjectives (mi, mis, tu, tus, su, sus).</p> <p>Process: Vocabulary and structures for managing turn-taking: Es tu turno. ¿Es mi turno? No, es el turno de Sara. Te toca a ti. ¿A quién le toca? Le toca a Sara. Tienes que esperar tu turno. Vocabulary for crossword puzzles: ¿Cuál es el número cinco horizontal? Words for categorizing: idéntico, casi idéntico, diferente. Phrases for encouraging participation: ¿Emma, qué piensas? Paulo, ¿puedes ayudarnos? Vocabulary for the project: mi árbol genealógico, ¿Cómo se dice en español?</p>	

General Outcomes

Applications (A) Students will use Spanish in a variety of situations and for a variety of purposes	Language Competence (LC) Students will use Spanish effectively and competently	Global Citizenship (GC) Students will acquire the knowledge, attitudes, and skills to be effective global citizens	Strategies (S) Students will know and use strategies to maximize the effectiveness of learning and communication
---	--	--	--

Specific Outcomes

The following specific outcomes are the focus of all or most of the instructional strategies described in the sample unit below:

Applications (A) • Ask for and share information • Understand and respond to simple predictable questions	Language Competence (LC) • Use a repertoire of words and phrases in familiar contexts, within the areas of experience of the family and family celebrations • Interact, in modelled situations, using short, simple words and phrases	Global Citizenship (GC) • Recognize similarities between their own culture and Spanish-speaking cultures	Strategies (S) • Use cognitive, metacognitive, social, and affective strategies with guidance to enhance language learning • Use interactive, interpretive, and productive strategies with guidance
--	--	--	--

In addition, other specific outcomes related to particular instructional strategies are indicated in the left-hand column opposite the description. In the case of Strategies, the left-hand column lists specific strategies that are suggested in the learning activities.

Specific Outcomes	Instructional Strategies	Assessment, Resources, Notes
<ul style="list-style-type: none"> Repeat words or phrases, associate new words or expressions with familiar ones (S—cognitive) 	<p>1. Show a family picture, preferably taken on the occasion of a family celebration, and ask students who they think the people are, how they are related to each other, and what they appear to be doing. As the students speculate about the family members, write the words for various family members on chart paper. Add vocabulary and structures to the chart throughout the activities that follow. Keep the chart posted in the classroom throughout the unit.</p> <p>Briefly discuss the concept of extended family and nuclear family, and ask students what kinds of events their family celebrates together.</p>	<ul style="list-style-type: none"> Use a picture from a text book, a personal family picture, or a picture of a famous Hispanic family. Students will probably be familiar with the concepts of extended and nuclear family from social studies. Make the connection to Spanish-speaking cultures. Keep anecdotal records of the students' participation, and their willingness to observe differences without passing judgment.
<ul style="list-style-type: none"> Make choices about how they learn, make a plan in advance about how to approach a language learning task (S—metacognitive) 	<p>2. Discuss the task with students. Decide together what information should be included on the family tree (e.g., nombre, fecha, y lugar de nacimiento) and what form the presentation of the project can take (e.g., include a brief description of one family celebration). Discuss what students will need to learn in order to be able to carry out the task. Establish criteria for the assessment of the project.</p>	<ul style="list-style-type: none"> When students have a project or a task that they are working towards, and are able to make choices about how they learn, motivation is generally increased.
<ul style="list-style-type: none"> Use possessive adjectives (mi, mis, tu, tus, su, sus) in modelled situations (LC—attend to form) Manage turn-taking (A—getting things done) 	<p>3. Play the game "La lista interminable" in groups of five to seven students. The first student begins by saying, "En mi familia, está mi madre." The second student repeats what the first one said and adds another family member, "En mi familia está mi madre y está mi hermano." Continue in this way until everyone has had a turn. If necessary, do a mini-lesson on possessive adjectives before playing the game.</p>	<ul style="list-style-type: none"> Monitor the students' use of the possessive adjective and the vocabulary for family members (including pronunciation). Review and reteach as necessary. If necessary, teach students the phrases needed to manage turn-taking. Te toca a ti. ¿Es mi turno? No, le toca a Sara.
<ul style="list-style-type: none"> Manage turn-taking (A—getting things done) Use a repertoire of words and phrases in familiar contexts, within the areas of experience of the family Interact, in modelled situations, using short, simple words and phrases 	<p>4. Have the students work in pairs to do an interactive crossword puzzle. One student has the vertical clues and the other has the horizontal clues. Students first complete their half of the puzzle and then take turns asking their partner for the remaining clues. They do not look at each other's puzzle until the end of the activity.</p>	<ul style="list-style-type: none"> Copies A and B of a crossword puzzle for each pair. (¡Dime! Uno, p. 162) Using a checklist or rating scale, monitor the extent to which students use Spanish during vocabulary building activities. See "Rating Scale for Interactive Activities" for an example.

Specific Outcomes	Instructional Strategies	Assessment, Resources, Notes
<ul style="list-style-type: none"> Organize, categorize, and sequence elements (A—extend their knowledge of the world) Recognize similarities and differences between their first language and Spanish (GC—affirm diversity) Know that languages can be grouped into families based on common origins (GC—affirm diversity) 	<p>5. Give students a list of words related to the theme of family in Spanish, English, French, German, Italian, and Portuguese. Have students work in cooperative groups to categorize the words according to commonalities. Ask students to speculate on the reasons for the similarities they have observed and to draw some conclusions about how languages evolve.</p> <p>When students are working in cooperative groups, pre-teach one group skill and have them focus on that skill during the activity (e.g., encourage participation from all group members).</p> <p>If necessary, teach students some vocabulary for categorizing elements of a list (e.g., <i>idéntico, casi idéntico, diferente</i>) and for encouraging participation (e.g., Emma, ¿qué piensas de esto/eso? Paul, ¿puedes ayudarnos?).</p>	<ul style="list-style-type: none"> One copy per group of the worksheet “Another Kind of Family” See “The Indo-European Language Family Tree” for background information. For additional information and colour charts, see “Family Tree of Indo-European Languages” at <http://www.danshort.com/1e/>. Keep anecdotal records of the students’ participation, and their ability to recognize similarities and differences.
<ul style="list-style-type: none"> Use interrogative sentences [yes/no questions and question words ¿Quién (es)? ¿Qué? ¿Cómo? ¿Cuál(es)? ¿Cuándo?] in modelled situations (LC—attend to form) 	<p>6. Play “Information Search.” Ask students to complete a questionnaire related to family members and family celebrations. After they have found a person for each question, they should ask a supplementary question to get more information (e.g., —¿Tienes un hermano? —Sí —¿Cómo se llama tu hermano? —Mi hermano se llama Justin).</p> <p>After the activity, discuss the information gathered by the students. Discuss family celebrations, what events are celebrated by the whole family, as well as similarities and differences from one family to another, and one culture to another.</p>	<ul style="list-style-type: none"> If necessary do a mini-lesson on the question forms needed to do the activity. See “Rating Scale for Interactive Activities” for an example of criteria for assessing students during the “Information Search.” Keep anecdotal records of the students’ participation in the discussion and their willingness to observe differences without passing judgement.
<ul style="list-style-type: none"> Understand the meaning of simple sentences in guided situations (LC—aural interpretation) Listen or look for key words (S—interpretive) 	<p>7. Have students view a video featuring someone presenting a family. Before viewing the video ask students to suggest some words and phrases they might expect to hear. Write key words and phrases on the board. Play the video several times, asking students to listen for particular information each time. For example, the first time have students listen only for the names of family members. The next time, ask them to listen for the age of family members, and so on.</p>	<ul style="list-style-type: none"> Video from ¡Dime! Uno, unidad 4, lección 1 Have the video available to students to use as a model when they are preparing to present their family. Have students reflect on their use of strategies using the “Reflective Checklist for Student Self-Assessment of Strategies.”

Specific Outcomes	Instructional Strategies	Assessment, Resources, Notes
<ul style="list-style-type: none"> Understand the meaning of short, simple texts in guided situations (LC—written interpretation) Infer probable meaning of unknown words or expressions from contextual clues (S—interpretive) 	<p>8. In cooperative groups have the students read an authentic text about a family, such as the website of the royal family of Spain, and answer specific questions. Coach students on reading strategies, such as looking for cognates and deducing meaning from contextual clues. They do not need to understand every word in the texts.</p> <p>Ask students about the role of the royal family in Spanish society. How does it compare with the role of the British royal family, for example?</p>	<ul style="list-style-type: none"> Website of the Spanish royal family: <http://www.casareal.es/casareal/familia.html> and activity sheet "La Familia Real" Alternatively, choose a text about a different famous Spanish-speaking family. "Reflective Checklist for Student Self-Assessment of Strategies" Keep anecdotal records of the students' participation in the discussion, and their willingness to observe differences without passing judgment.
<ul style="list-style-type: none"> Produce meaningful short, simple phrases and sentences in guided situations (LC—written production) Use a variety of resources to correct texts (S—productive) 	<p>9. Students prepare their projects. They should have as much freedom as possible to choose the particular format they will use for their family tree within the guidelines established at the beginning of the unit. Although they are working on individual family trees, they can work in groups, sharing materials and equipment and providing peer feedback.</p>	<ul style="list-style-type: none"> Encourage students to use word lists and grammar charts posted in the classroom, their personal dictionaries, as well as their classmates to correct the final version of their family tree. "Form for Assessment of Project and Oral Presentation"
<ul style="list-style-type: none"> Produce meaningful words, phrases, and short, simple sentences in guided situations (LC—oral production) Use possessive adjectives (mi, mis, tu, tus, su, sus) in modelled situations (LC—attend to form) 	<p>10. Students present their project to their classmates and answer questions about their family and their family celebration.</p>	<ul style="list-style-type: none"> "Form for Assessment of Project and Oral Presentation"
<ul style="list-style-type: none"> Evaluate their own performance or comprehension at the end of a task (S—metacognitive) 	<p>11. Look back on the unit and guide students to reflect on what they have learned, what they found interesting and what they need to do more work on.</p>	<ul style="list-style-type: none"> "Reflective Checklist for Student Self-Assessment of Strategies" Make a note of changes that would improve the unit if it were taught again in the future.

Unit Components

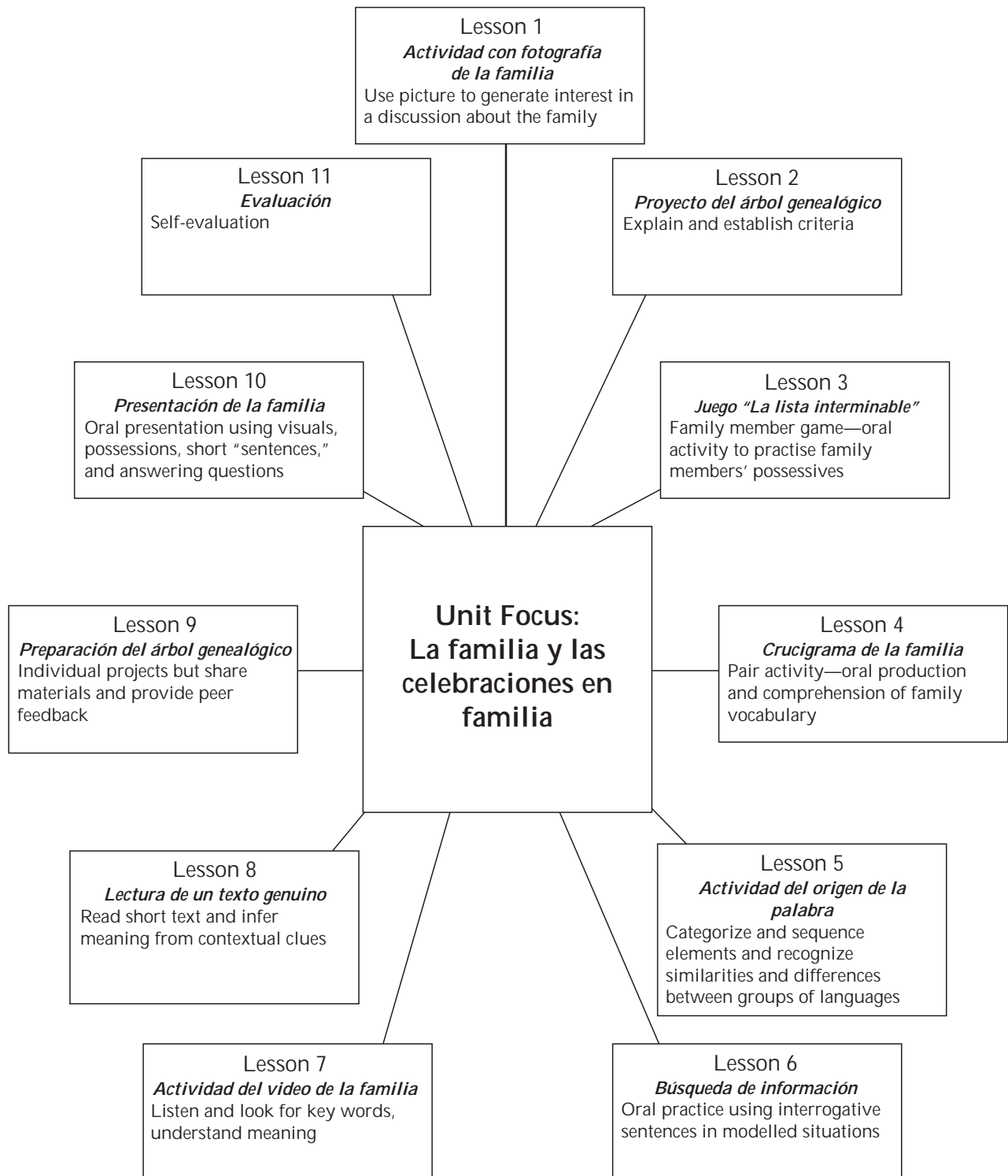

Lesson Plan Format
Subject(s): _____ The Family and Family Celebrations _____
Lesson plan made by: _____ Grade: _____ School: _____ Date: _____

Learner Outcomes:

Planning for diversity of learners: Provide a variety of family pictures.	Prerequisite knowledge, skills, strategies, and attitudes: Students will be familiar with concepts of extended and nuclear family from social studies.
--	---

Organization decisions to achieve the outcomes:

	Time*	Learning Activities	Instructional Strategies	Resources
Introduction	15	Students talk about who they think the people are and how they relate to each other.	Show a family picture and ask questions.	Family picture
Sequence of activities in main body of lesson	20	Students speculate about family members.	Write the words for various family members on chart paper.	Chart paper
Conclusion	20	Students discuss the concept of extended and nuclear family and family celebrations.	Add vocabulary and structures to the chart and keep the chart posted in the classroom.	

<p>Assessment and Evaluation</p> <p>Keep anecdotal records of the students' participation and willingness to observe differences and connections to the Spanish-speaking cultures.</p>

* Lesson plans are made on the assumption that classes are approximately 60 minutes.

The Indo-European Language Family Tree By Jack Lynch, Rutgers—Newark

The chart below shows the relations among some of the languages in the Indo-European family. Though you wouldn't think it to look at the tangle of lines and arrows, the chart is very much simplified: many languages and even whole language families are left out. Use it, therefore, with caution. The coverage is most thorough, but still far from complete, in the Germanic branch, which includes English.

The dotted line from French to Middle English suggests not direct descent, but the influx of French vocabulary in the centuries after the Norman Invasion.

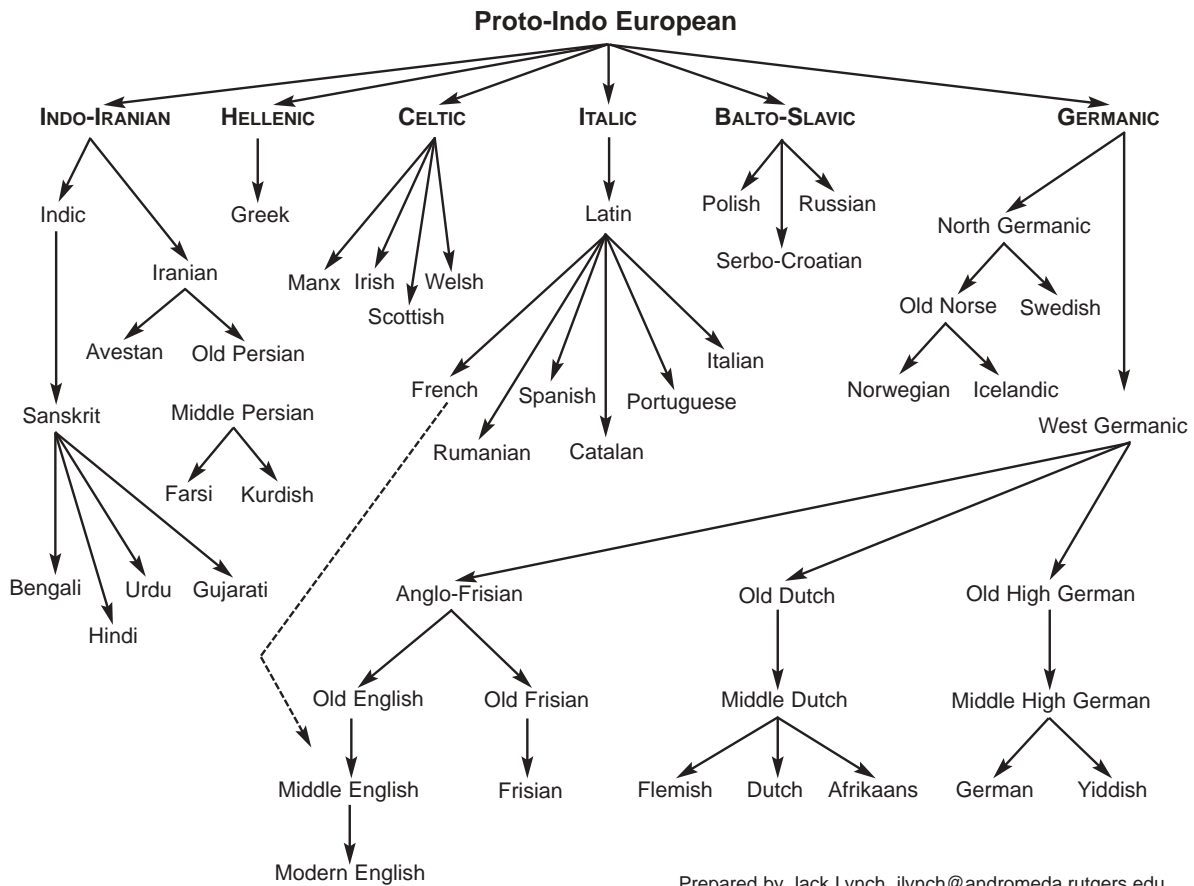

Some caveats. In the interest of making this readable, I've left out dozens of languages. I've even omitted the entire Anatolian, Albanian, and Tocharian families; I've included no languages from the Baltic branch or the Continental Celtic branch; I've grossly oversimplified the Indo-Iranian family; and so on. The historical phases of some languages—Old Swedish, Middle Swedish, Modern Swedish; Vedic Sanskrit, Middle Indic—have been left out. I've made no attempt to distinguish living languages from dead ones. My goal is simply to give some idea of the origins of the English language, and its relations to other familiar languages—along with a few less familiar ones.

Another Kind of Family

On this page you will find 30 words from six different languages. In your group try to categorize these words based on similarities. When you are finished, answer the questions at the bottom of the page.

brother	vater	irmão	familia
fratello	tía	familia	tante
tante	sobrina	zia	sobrinha
father	pai	aunt	père
famiglia	frère	niece	padre
nièce	familie	nipote	tía
family	bruder	famille	hermano
padre	nichte		

1. What are the six languages? (*¿Cuáles son las seis lenguas?*)

2. What characteristics do you use to categorize the words? (*¿Qué características usas para categorizar las palabras?*)

3. Speculate on the reasons for the similarities you found. (*Adivina por qué son similares.*)

4. Can you think of ways of using these similarities to help you learn Spanish? (*¿Cómo puedes usar estas semejanzas para aprender español?*)

Another Kind of Family—Answer Key

On this page you will find 30 words from six different languages. In your group try to categorize these words based on similarities. When you are finished, answer the questions at the bottom of the page.

brother	vater	irmão	familia
fratello	tía	familia	tante
tante	sobrina	zia	sobrinha
father	pai	aunt	père
famiglia	frère	niece	padre
nièce	familie	nipote	tía
family	bruder	famille	hermano
padre	nichte		

inglés	alemán	francés	español	italiano	portugués
brother	bruder	frère	hermano	fratello	irmão
aunt	tante	tante	tía	zia	tía
father	vater	père	padre	padre	pai
niece	nichte	nièce	sobrina	nipote	sobrinha
family	familie	famille	familia	famiglia	familia

1. What are the six languages? (*¿Cuáles son las seis lenguas?*)
2. What characteristics do you use to categorize the words? (*¿Qué características usas para categorizar las palabras?*)
3. Speculate on the reasons for the similarities you found. (*Adivina por qué son similares.*)
 - Common origins of Romance languages (Spanish, French, Italian, Portuguese) in Latin/*Orígenes comunes de las lenguas romance (español, francés, italiano, portugués) en latín*
 - English has origins in both French and German/*El inglés tiene sus orígenes en el francés y el alemán*
4. Can you think of ways of using these similarities to help you learn Spanish? (*¿Cómo puedes usar estas semejanzas para aprender español?*)
 - Try to transfer knowledge of one language with which you are familiar to another (e.g., If you speak Portuguese, you should be able to guess that “Sobrina” = “Sobrinha.”).

Another Kind of Family—Answer Key (continued)

8. Can you think of ways of using these similarities to help you learn Spanish./ *¿Cómo puedes usar estas semejanzas para aprender español?*

Cognitive language learning strategies such as the following./ *Estrategias cognitivas para el aprendizaje de la lengua, tales como:*

- Look for patterns and relationships./ *Busca estructuras comunes y relaciones.*
- Identify similarities and differences between Spanish and English (and other languages you know or are learning)./ *Identifica semejanzas y diferencias entre el español y el inglés (y otras lenguas que conoces o que estás aprendiendo).*
- Group together sets of things with similar characteristics./ *Asocia nuevas palabras o expresiones con las ya conocidas.*
- Associate new words or expressions with familiar ones./ *Agrupar palabras con características similares.*

**Rating Scale for Interactive Activities—Formative Assessment/
Escala de clasificación para actividades interactivas—Evaluación formativa**

Name of Activity/
Título de la actividad: _____

Date/
Fecha: _____

Criteria for Assessment/ <i>Criterios de evaluación</i> → Names of students/ <i>Nombre de los estudiantes</i> ↓	Uses Spanish (short, simple words and phrases) when interacting with other students/ <i>Usa el español (breve, palabras o frases simples) cuando interactúa con otros estudiantes</i>	Is able to understand and respond to simple, predictable questions in Spanish/ <i>Es capaz de comprender y responder en español preguntas sencillas y fáciles de predecir</i>	Uses the vocabulary for family members with increasing accuracy and confidence/ <i>Usa el vocabulario para miembros de la familia con creciente precisión y confianza</i>	Understands that playing interactive games is an effective strategy for language learning/ <i>Comprende que el jugar juegos interactivos es una estrategia eficaz para aprender idiomas</i>

0-not at all/*nunca*; 1-occasionally/*a veces*; 2-often/*con frecuencia*; 3-consistently/*con consistencia*

Additional Comments/*Comentarios adicionales*

La Familia Real

Visita el siguiente sitio web: <<http://www.casareal.es/casareal/familia.html>>. Haz un clic en *S.M. el Rey Don Juan Carlos, S.M. la Reina Doña Sofía, S.A.R. el Príncipe Don Felipe*.

1. *Nombra cognados (palabras que son similares al inglés).*

2. *Nombra palabras que adivinas a través del contexto.*

Lee con atención:

A. Haz un clic en *S.M. el Rey Don Juan Carlos* o visita <<http://www.casareal.es/casareal/reymbg.html>> y responde a las siguientes preguntas en español.

1. ¿Cómo se llama el rey? _____.
2. ¿De dónde es el rey? _____.
3. ¿Cuándo es su cumpleaños? _____.
4. ¿Cómo es el rey? _____.

B. Haz un clic en *S.M. la Reina Doña Sofía* (<<http://www.casareal.es/casareal/rnabg.html>>) y responde a las siguientes preguntas en español.

1. ¿Cómo se llama la reina? _____.
2. ¿De dónde es la reina? _____.
3. ¿Cuándo es su cumpleaños? _____.
4. ¿Cómo es la reina? _____.

C. Haz un clic en *S.A.R. el Príncipe Don Felipe*

(<<http://www.casareal.es/casareal/ppdbg.html>>) y responde a las siguientes preguntas en español.

1. ¿Cómo se llama el príncipe? _____.
2. ¿De dónde es el príncipe? _____.
3. ¿Cuándo es su cumpleaños? _____.
4. ¿Cómo es el príncipe? _____.

D. Haz un clic en *árbol genealógico de la familia real*

(<<http://www.casareal.es/casareal/arbfr.html>>) y responde a las siguientes preguntas en español.

1. ¿Cuántos hermanos tiene la reina Doña Sofía? _____.
2. ¿Quién es la madre de Don Juan Carlos? _____.
3. ¿Cómo se llama un tío de Don Juan Carlos? _____.
4. ¿Quién es la hermana de Doña Sofía? _____.
5. ¿Cuántos hijos tienen Don Juan Carlos y Doña Sofía? _____.
6. ¿Cómo se llama el abuelo de Don Juan Carlos? _____.
7. ¿Cómo se llaman los primos de Pablo? _____.
8. ¿Quién es el esposo de Elena? _____.
9. ¿Cómo se llama el tío del hijo de Don Juan Carlos? _____.
10. ¿Quién es Pilar? _____.

Busca a una persona	Firma	Haz una pregunta adicional relacionada y escribe la respuesta aquí
1. que tiene un hermano (¿Tienes un hermano?)		
2. que tiene una hermana casada (¿Tienes una hermana casada?)		
3. que tiene su cumpleaños en junio (¿Es tu cumpleaños en junio?)		
4. que tiene más de cinco primos (¿Tienes más de cinco primos?)		
5. que invita a sus abuelos a su cumpleaños (¿Invitas a tus abuelos a tu cumpleaños?)		
6. que tiene una boda en la familia este año (¿Tienes una boda en la familia este año?)		
7. que su abuela vive en su casa (¿Tu abuela vive en tu casa?)		
8. que tiene un pariente que habla español (¿Tienes un pariente que habla español?)		
9. que tiene un tío soltero (¿Tienes un tío soltero?)		
10. que tiene una madrastra o un padrastro (¿Tienes una madrastra o un padrastro?)		

**Assessment of Project (Family Tree) and
Oral Presentation/*Evaluación del proyecto
(El árbol genealógico) y de la presentación oral***

Student's Name/ *Nombre del estudiante*: _____

Date/ *Fecha*: _____

Family Tree/Arbol genealógico	
<ul style="list-style-type: none"> • has provided names and dates of birth and death (if applicable) of at least three generations in Spanish/ <i>ha proporcionado en español los nombres y las fechas de nacimiento y defunción (si es necesario) de por lo menos tres generaciones</i> 	/20
<ul style="list-style-type: none"> • has organized the information so as to clearly show relationships/ <i>ha organizado la información para mostrar claramente las relaciones</i> 	/5
<ul style="list-style-type: none"> • has indicated his/her relationship to each family member/ <i>ha indicado su relación con cada miembro de la familia</i> 	/10
<ul style="list-style-type: none"> • has used vocabulary for family members correctly/ <i>ha usado correctamente el vocabulario para los miembros de la familia</i> 	/5
<ul style="list-style-type: none"> • has used possessive adjectives correctly/ <i>ha usado correctamente los adjetivos</i> 	/5
<ul style="list-style-type: none"> • has used a variety of resources (including word lists, peers, teacher) to correct the final version of his/her family tree/ <i>ha usado una variedad de recursos (incluyendo listas de palabras, a sus compañeros, al profesor/ a la profesora) para corregir la versión final de su árbol genealógico</i> 	/5
TOTAL	/50

(continued/continuado)

**Assessment of Project (Family Tree) and
Oral Presentation (continued)/Evaluación del proyecto
(El árbol genealógico) y de la presentación oral (continuado)**

Presentation and Response to Questions/ Presentación y respuesta a las preguntas	
• has provided additional information about family members/ <i>ha proporcionado información adicional sobre los miembros de su familia</i>	/10
• has identified a family celebration and provided some additional information/ <i>ha identificado una celebración familiar y ha proporcionado información adicional</i>	/10
• is able to form short, simple sentences when speaking to the group/ <i>es capaz de enunciar oraciones cortas y sencillas cuando habla frente al grupo</i>	/10
• uses vocabulary for the family and possessive adjectives with reasonable accuracy/ <i>usa el vocabulario para la familia y los adjetivos posesivos con razonable precisión</i>	/10
• understands and responds to questions from classmates using short, simple words and phrases/ <i>comprende y responde a las preguntas de sus compañeros usando palabras y frases cortas y sencillas</i>	/5
• uses interactive and productive strategies as needed with guidance from the teacher if necessary/ <i>usa estrategias interactivas y creativas según se necesite con ayuda del profesor/ la profesora si es necesario</i>	/10
TOTAL/TOTAL	/50
PROJECT MARK/PUNTAJE DEL PROYECTO	/100

Comments/ *Comentarios:*

**Reflective Checklist for Student
Self-Assessment of Strategies/
*Lista de verificación para el estudiante
Autoevaluación de las estrategias***

Student's Name/ *Nombre del estudiante*: _____

Date/ *Fecha*: _____

Watching a video/ *Para mirar un video*:

- Before watching the video, I tried to predict some words and phrases I would hear./ *Antes de mirar el video, traté de predecir algunas palabras y frases que iba a escuchar.*
- During the video, I tried to focus only on the information I needed to find./ *Durante el video, traté de concentrarme sólo en la información que necesitaba encontrar.*
- During the video, I tried to use the pictures to help me understand the words./ *Durante el video, traté de usar las imágenes para ayudarme a entender las palabras.*

Other strategies I used to help me understand/ *Otras estrategias que usé para ayudarme a comprender*: _____

Reading about a family/ *Para leer sobre una familia*:

- Before reading the text, I looked for words that are the same as or similar to English words./ *Antes de leer el texto, busqué palabras que son iguales o similares a palabras en inglés.*
- When I found a word I did not know, I tried to guess the meaning from the other words around it./ *Cuando encontré una palabra que no conocía, traté de adivinar el significado a través de las palabras alrededor de ella.*
- I used the questions as a guide to try to find the information I needed. I understand that I don't need to understand every word./ *Usé las preguntas como una guía para tratar de encontrar la información que necesitaba. Yo comprendo que no tengo que entender cada palabra.*

Other strategies I used to help me understand/ *Otras estrategias que usé para ayudarme a comprender*: _____

(continued/continuado)

Reflective Checklist for Student
Self-Assessment of Strategies (continued)/
Lista de verificación para el estudiante
Autoevaluación de las estrategias (continuado)

Reflection on the Unit/Reflexión sobre la Unidad:

1. The most useful thing I learned in this unit was/*La cosa más útil que aprendí en esta unidad fue*

2. The most interesting or most fun activity was/*La actividad más interesante o más divertida fue*

3. What I need to work on next is/*Lo siguiente que necesito trabajar es*

Year 3: Sample Unit
Cultural Diversity in the
Spanish-Speaking World

Sample Unit on Diversity in Spanish-Speaking Countries

Topic/Theme: La diversidad cultural en los países de habla hispana	Task: Prepare and present a poster/collage of one immigrant group to a Spanish-speaking country. Alternate Tasks: Research project on the cultural diversity of one Spanish-speaking country, including information about different climates, history, and how these factors contribute to cultural diversity of the country.
Grade Level: Year 3	
Analysis of language needs to complete task: Product: Vocabulary related to immigration: la raza, los indígenas (azteca, maya, inca), la población, los mulatos, los mestizos, la inmigración, los inmigrantes, la emigración, los emigrantes, la minoría, la demografía, la conquista, la distribución, la influencia, el origen, la comunidad, etc. Vocabulary related to countries, languages, nationalities: la diversidad, multicultural, diversidad de razas, el clima, las industrias, la historia, la política, la economía Process: Vocabulary related to maps: norte, sur, este, oeste, arriba, abajo, a la derecha, a la izquierda, aquí, allí, en esta zona/región Vocabulary related to preparing an interview: ¿Cuándo ...? ¿Desde cuándo ...? ¿Hace cuánto tiempo que ...? ¿Por qué inmigró ...? ¿Cómo es ...? Phrases for making a guest feel welcome: Bienvenido/a/s, Gracias por venir, Muchísimas gracias, Le agradecemos	

General Outcomes

Applications (A)

Students will use Spanish in a variety of situations and for a variety of purposes

Language Competence (LC)

Students will use Spanish effectively and competently

Global Citizenship (GC)

Students will acquire the knowledge, attitudes, and skills to be effective global citizens

Strategies (S)

Students will know and use strategies to maximize the effectiveness of learning and communication

Specific Outcomes

The following specific outcomes are the focus of all or most of the instructional strategies described in the sample unit below:

Applications (A)

- inquire about and give simple reasons for thoughts and preferences
- ask questions to gain knowledge and clarify understanding
- record, organize, categorize, and sequence elements using a variety of sources
- use language creatively and for aesthetic purposes

Language Competence (LC)

- provide a variety of meaningful, short, simple texts in guided and unguided situations
- attend to form (grammatical chart)
- oral production
- aural, written, and interactive fluency
- use of formal and informal registers

Global Citizenship (GC)

- understand major factors that influence diversity
- know that diversity exists within the culture of any Spanish-speaking country
- show an interest in other languages and cultures

Strategies (S)

- select and use social and affective strategies independently to enhance language learning (e.g. take part in group)
- select and use cognitive strategies independently to enhance language learning (look for patterns and relationships)

In addition, other specific outcomes related to particular instructional strategies are indicated in the left-hand column opposite the description. In the case of Strategies, the left-hand column lists specific strategies that are suggested in the learning activities.

Specific Outcomes	Instructional Strategies	Assessment, Resources, Notes
<ul style="list-style-type: none"> Select and use social and affective strategies independently to enhance language learning (e.g., take part in group) 	<ol style="list-style-type: none"> As an introductory activity, provide students with fortune cookies. In small groups, have students discuss the fortunes and choose one fortune, write it in Spanish and present it to the class. Discuss the fact that fortune cookies are often associated with the Chinese cultural group, which has immigrated to Canada and to Spanish-speaking countries. 	<ul style="list-style-type: none"> The Evolving Multicultural Classroom Rose Reissman, ASCD, USA, 1994 <http://www.chcp.org/Vfortune.htm> <http://www.democracyweb.com/modelminority.com/history/cookies.htm> Assessment based on observation of group interaction and discussion
<ul style="list-style-type: none"> Show an interest in other languages and cultures 	<ol style="list-style-type: none"> Brainstorm with students the different Spanish-speaking immigrant groups that have come to Canada. 	<ul style="list-style-type: none"> Immigration Canada on Internet Assessment—Web of different immigrant groups
<ul style="list-style-type: none"> Know that diversity exists within the culture of any Spanish-speaking country Show an interest in other languages and cultures 	<ol style="list-style-type: none"> Have students examine maps that indicate languages spoken in countries of the world. Have students identify different cultural groups that exist in Canada and in Latin America. 	<ul style="list-style-type: none"> Immigration Canada on Internet Atlases, maps
<ul style="list-style-type: none"> Record, organize, categorize, and sequence elements using a variety of sources Understand major factors that influence diversity 	<ol style="list-style-type: none"> Have students work in pairs or in small groups to read an article on immigration patterns in Latin America. Have students prepare a chart that lists various Spanish-speaking countries, the immigrant group(s) who came to that country, and reasons for their immigration 	<ul style="list-style-type: none"> Buen Viaje 2, Capítulo 9, p. 266-267 Buen Viaje 3, Capítulo 8, p. 383 Dime Pasaporte al mundo 21 Obtain and copy article: Chapter 8: Latinoamérica a vista de pájaro, pages 131-138 from Arturo A. Fox, Latinoamérica: Presente y pasado, Prentice Hall, Upper Saddle River, New Jersey 07458, 1998 Assessment: Chart of Immigration Patterns in Latin America
<ul style="list-style-type: none"> Attend to form 	<ol style="list-style-type: none"> Direct Instruction of Preterito and Preterito Perfecto 	

Specific Outcomes	Instructional Strategies	Assessment, Resources, Notes
<ul style="list-style-type: none"> • Use language creatively and for aesthetic purposes • Produce a variety of meaningful, short simple oral and written texts in guided and unguided situations 	<p>6. Have students work individually or in partners to prepare a poster/collage of one immigrant group to a Spanish-speaking country. Students must provide written information about the immigrant group as well as reasons why the group immigrated. Have students use an inquiry plan such as that provided on pages Year 3 – 85–86 in order to guide them in their research. Have students present their poster and information orally and then display in the class.</p>	<ul style="list-style-type: none"> • Assessment: <ul style="list-style-type: none"> — Inquiry Exit Slip — Report Checklist — Oral Presentation Checklist — Oral Presentation Self-Assessment
<ul style="list-style-type: none"> • Know that diversity exists within the culture of any Spanish-speaking country • Show an interest in other languages and cultures • Know that diversity exists within the culture of any Spanish-speaking country • Oral/Written Production—Produce a variety of meaningful, short, simple texts, in guided and unguided situations 	<p>Alternate Task:</p> <p>7. a) Do a study with the students about native cultural diversity within a country. Have students watch a video about Chile and its different regions. Note with students the differences in the cultures and lifestyles of the people from the desert north to the snowy southern tip. Have students examine how climate affects the differences in lifestyle.</p> <p>b) Have each student pick a Spanish-speaking country and research the cultural diversity of the country. Different climates, industries, and history should be addressed and how these factors contribute to cultural diversity and traditions in each region of the country. Visuals must be included as well as a bibliography of current resources.</p>	<ul style="list-style-type: none"> • Pasaporte al mundo 21 • Lonely Planet/ Pilot Guides • West of the Andes—IRU #8436 • Introducing Chile • Globe Trekker—Chile and Easter Island • Full Circle with Michael Palin: Chile/Bolivia and Peru • Los Milagros de Chile • Magallones, Chile • Ruta del descubrimiento • Lonely Planet/Pilot Guides • Abrir Paso • Video Resources: <ul style="list-style-type: none"> — Introducing Latin America, Part 2: The People — Un Paseo por Bolivia — Un Paseo por Colombia — Un Paseo por Ecuador — Un Paseo por Perú — Un Paseo por Venezuela — Bien venidos a Costa Rica — Mexican Popular Customs (Spanish Version) • Assessment: <ul style="list-style-type: none"> — Inquiry Exit Slip — Report Checklist — Oral Presentation Checklist — Oral Presentation Self-Assessment • Rubric for research project

Specific Outcomes	Instructional Strategies	Assessment, Resources, Notes
<ul style="list-style-type: none"> Apply interpersonal skills to initiating and maintaining new relationships (make a new classmate feel welcome) 	<p>8. Have students interview a native Spanish-speaker from their school or invite a native Spanish-speaker to class. Have students listen to the speaker's life story. Have students prepare questions for the guest about his/her native country and his/her reasons for immigrating.</p>	<ul style="list-style-type: none"> Assessment: Observation: Have the students made the speaker feel welcome? Have the students shown a legitimate interest in the speaker's life? Are the questions relevant and well thought-out?
<ul style="list-style-type: none"> Aural Interpretation—understand the meaning of a variety of simple texts, in guided and unguided situations Interactive Fluency—interact using a combination of sentences, in guided and unguided situations Apply interpersonal skills to initiating and maintaining new relationships 	<p>9. To finalize the unit, discuss with the class stereotypes and generalizations that are made of Spanish-speaking people. Have students enter a reflection in their journal in response to the following question: How did this unit challenge generalizations about Spanish-speaking people?</p>	<ul style="list-style-type: none"> Assessment: Reflection Journal

Unit Plan: La diversidad cultural en los países de habla hispana						
Day/ Sequence	Lesson Topics	Outcomes	Instructional Strategies and Learning Activities	Major Resources	Assessment/ Evaluation	Planning for Diversity of Learners
Day 1	Tradiciones culturales e inmigración	<ul style="list-style-type: none"> enquire about and give simple reasons for thoughts and preferences 	<ul style="list-style-type: none"> provide students with fortune cookies students discuss fortunes and Chinese culture write in Spanish 	<ul style="list-style-type: none"> Book—Evolving Multicultural Classroom www.democracyweb.com 	<ul style="list-style-type: none"> observe group interaction 	<ul style="list-style-type: none"> using the cookies, encourage class discussion talking with other immigrant groups
Day 2	Los grupos de inmigrantes en Canadá	<ul style="list-style-type: none"> show an interest in other languages and cultures 	<ul style="list-style-type: none"> brainstorm different Spanish-speaking immigrant groups 	<ul style="list-style-type: none"> Immigration Canada on Internet 	<ul style="list-style-type: none"> web of different groups 	<ul style="list-style-type: none"> inviting all responses orally providing visual pictures—unbound
Day 3	Los grupos culturales en Canadá y Latinoamérica	<ul style="list-style-type: none"> know that diversity exists 	<ul style="list-style-type: none"> examine maps, identify cultural groups 	<ul style="list-style-type: none"> atlases Internet maps book, Imágenes de America Latina, Capítulo 1 	<ul style="list-style-type: none"> create pie charts for Canada and Latin America showing diverse cultural groups 	<ul style="list-style-type: none"> encouraging students to talk about their ethnic groups provide simple/more complicated groups
Day 4	Los inmigrantes en los países de habla hispana	<ul style="list-style-type: none"> record, organize, categorize, sequence elements 	<ul style="list-style-type: none"> prepare charts <ul style="list-style-type: none"> list Spanish-speaking countries immigrant groups in those countries 	<ul style="list-style-type: none"> Buen Viaje 2 & 3 Pasaporte al Mundo 21 Latinoamérica Presente y pasado 	<ul style="list-style-type: none"> create a chart/map of immigration patterns in Latin America 	<ul style="list-style-type: none"> encourage students to brainstorm and then research possible reasons for immigration
Day 5	Los inmigrantes en acción	<ul style="list-style-type: none"> attend to form pretérito and pretérito perfecto 	<ul style="list-style-type: none"> use charts, maps, and webs to introduce verbs/actions in the past teach pretérito and pretérito perfecto through direct method of instruction 	<ul style="list-style-type: none"> teacher-created handouts classroom textbook 	<ul style="list-style-type: none"> fill in verbs in blanks using sentences relative to lesson topics 	<ul style="list-style-type: none"> provide additional grammatical exercises
Day 6	Los grupos de inmigrantes y las razones para inmigrar	<ul style="list-style-type: none"> use language creatively and for aesthetic purposes oral production 	<ul style="list-style-type: none"> students prepare poster/collage of one immigrant group to a Spanish-speaking country present and display in the class 	<ul style="list-style-type: none"> Internet 	<ul style="list-style-type: none"> oral presentation checklist oral presentation self-assessment 	<ul style="list-style-type: none"> use inquiry plan to guide research

Unit Plan: La diversidad cultural en los países de habla hispana							
Day/Sequence	Lesson Topics	Outcomes	Instructional Strategies and Learning Activities	Major Resources	Assessment/Evaluation	Planning for Diversity of Learners	
Day 7	La diversidad cultural en un país de habla hispana	<ul style="list-style-type: none"> understand major factors that influence diversity know that diversity exists within the culture of any Spanish-speaking country 	<ul style="list-style-type: none"> students research different aspects of a Spanish-speaking country that influenced cultural diversity 	<ul style="list-style-type: none"> Lonely Planet pilot guides Pasaporte al Mundo 21 Abrir Paso 	<ul style="list-style-type: none"> oral presentation checklist oral presentation self-assessment rubric for research project 	<ul style="list-style-type: none"> provide a checklist for organizational purposes 	
Day 8	Los inmigrantes hispanos en Canadá	<ul style="list-style-type: none"> ask questions to gain knowledge and clarify understanding use of formal and informal registers apply interpersonal skills to initiating and maintaining new relationships 	<ul style="list-style-type: none"> students interview a Hispanic immigrant 	<ul style="list-style-type: none"> guest 	<ul style="list-style-type: none"> observe the interview and check <ul style="list-style-type: none"> — student interest — relevant questioning — guest's comfort level 	<ul style="list-style-type: none"> allow students to work in groups of two 	
Day 9	Los estereotipos relacionados con la gente de habla hispana	<ul style="list-style-type: none"> inquire about and give simple reasons for thoughts and preferences fluency—interact using a combination of sentences in guided and unguided situations 	<ul style="list-style-type: none"> discuss stereotypes and generalizations students enter a reflection in their journal 		<ul style="list-style-type: none"> reflection journal 	<ul style="list-style-type: none"> invite students to generate lists of stereotypes in groups, then share 	

Lesson 1: La diversidad cultural en los países de habla hispana						
Time	Organization	Materials	Outcomes	Stage	Procedure	
10 minutes	groups of 3/4	fortune cookies	aural, written, and interactive fluency	Warm-up Introduction	Provide students with fortune cookies and have students discuss the fortunes and choose fortune	
5 minutes	individual	fortune cookies	attend to form	Stage I	Students write out the fortune they chose in Spanish	
15 minutes	whole class/ individual	fortune cookies	oral production	Stage II	Students present their fortune to the class	
15 minutes	class	fortune cookies	show an interest in other languages and cultures	Conclusion	Students discuss the fact that fortune cookies are often associated with the Chinese cultural groups who have immigrated to Canada and the Spanish-speaking countries	

Lesson Plan Time: 45 minutes

Los idiomas y los países del mundo

Nombre : _____

Fecha: _____

En Canadá: ¿Cuáles son algunos idiomas importantes en Canadá? (Nombra seis idiomas)

En el mundo: ¿Cuáles son los idiomas más comunes en el mundo? (Nombra seis idiomas)

En los países hispanos: Aparte del español, ¿cuáles son otros idiomas comunes?

Ejemplo de un plan de búsqueda

(Adapted from Linda Ross, as found in Manitoba Education and Training, *Grades 5 to 8 English Language Arts: A Foundation for Implementation*, Grade 8 – 184–185)

Nombre: _____ Fecha: _____

Etapa 1—Preparar un objetivo y un plan

Haz una lluvia de ideas e identifica algunos temas de investigación/búsqueda. Apunta tus ideas y preguntas de investigación aquí abajo.

Tema: _____

Conocimientos previos: ¿Qué sabes ya sobre este tema? Apunta lo que sabes en forma esquemática o en un organizador gráfico.

¿Qué quieres saber? Prepara preguntas relevantes sobre el tema para establecer un objetivo para tu búsqueda. Escribe tus preguntas aquí abajo.

Prepara y usa un plan.

Mi audiencia es

Mi resultado final será _____

Prepararé mis apuntes usando ... (Marca lo que usarás).

- | | | |
|--|--|---|
| <input type="checkbox"/> forma esquemática | <input type="checkbox"/> esquema | <input type="checkbox"/> Slim Jims |
| <input type="checkbox"/> tabla, gráfico | <input type="checkbox"/> organizador gráfico | <input type="checkbox"/> Web/internet/red |
| <input type="checkbox"/> Tabla SQA Plus* | <input type="checkbox"/> I-tabla | |

Etapa 2—Obtener información

Marca los recursos usados

- | | | | | |
|---|-------------------------------------|--------------------------------------|---|------------------------------------|
| <input type="checkbox"/> catálogos en línea | <input type="checkbox"/> periódicos | <input type="checkbox"/> entrevistas | <input type="checkbox"/> enciclopedias | <input type="checkbox"/> internet |
| <input type="checkbox"/> experimentos | <input type="checkbox"/> CD-Roms | <input type="checkbox"/> diagramas | <input type="checkbox"/> tablas, gráficos | <input type="checkbox"/> encuestas |
| <input type="checkbox"/> recursos humanos | <input type="checkbox"/> almanaques | <input type="checkbox"/> videos | <input type="checkbox"/> documentales | <input type="checkbox"/> foros |
| <input type="checkbox"/> biografías | <input type="checkbox"/> debates | <input type="checkbox"/> artefactos | <input type="checkbox"/> otros | |

* See Teaching and Learning, p. 59.

Mis referencias de información son:

Escribe: Nombre del autor, título de referencia, fecha de publicación, lugar de publicación y nombre del editor.

Recuerda lo siguiente:

- Evalúa la exactitud, la fluidez, utilidad, cantidad (suficiente) y fiabilidad de los materiales de referencia usados. Evalúa usando una lista de criterios preparada por la clase o por ti. Adjunta tu evaluación de información a este organizador.
- Prepara tus apuntes usando el método que indicaste en la Etapa 1. Adjunta tus apuntes a este organizador.

Revisa tus apuntes para determinar si la información en tus apuntes es actual, pertinente y completa. Haz las correcciones necesarias en tus apuntes.

Etapa 3—Información de proceso

Escribe tu borrador. Asegúrate de usar detalles para sustentar las ideas principales. Adjunta tu borrador a este plan.

- Revisa usando un color diferente para:
 - ◆ eliminar información no pertinente
 - ◆ indicar brechas en la información presentada
 - ◆ aclarar ideas e información
 - ◆ ordenar la secuencia de ideas e información
 - ◆ generar interés del lector: escribiendo frases de manera eficaz y que expresen claramente el contenido
- Corrige usando un color diferente para:
 - ◆ el uso apropiado de palabras de transición y de conectores
 - ◆ la ortografía exacta
 - ◆ la puntuación y el uso apropiado de la letra mayúscula
 - ◆ las oraciones completas
 - ◆ la variedad de frases
 - ◆ el vocabulario apropiado
 - ◆ la gramática: el tiempo verbal, sujeto/verbo y la concordancia del sustantivo/ pronombre personal, modificadores apropiados
 - ◆ el tono apropiado para la audiencia
- Primero, revisa y corrige tu trabajo. Luego, revísalo y corrígelo con un compañero o con un grupo. Finalmente, revísalo y corrígelo con tu profesor.

Etapa 4—Presentar el resultado final

Comparte el resultado final de tu búsqueda con tu audiencia.

Etapa 5—Autoevaluarse y Reflexionar

Piensa en lo que aprendiste durante este proceso de investigación. ¿Cómo te afectó? ¿Cuáles fueron tus habilidades durante esta búsqueda? Apúntalas. Prepara nuevos objetivos para tu próxima búsqueda. Escribe tus reflexiones aquí abajo.

Boleta de salida de la investigación

(Adapted from Manitoba Education and Training, *Grades 5 to 8 English Language Arts: A Foundation for Implementation*, Grade 8 – 186)

Pida que los estudiantes rellenen esta boleta de salida después de cada clase de investigación. Se puede incluir lo siguiente en la boleta de salida de la investigación: sus reflexiones de lo que ha logrado o sus planes o agenda para la próxima clase.

Boleta de salida de la investigación	
Nombre: _____	Fecha: _____
Hoy he logrado:	

Boleta de salida de la investigación	
Nombre: _____	Fecha: _____
Mis planes y mi agenda para la próxima clase de investigación:	

Lista de verificación para el informe

(Adapted from Manitoba Education and Training, *Grades 5 to 8 English Language Arts: A Foundation for Implementation*, Grade 6 – 346)

Lista de verificación para el informe

Nombre _____ Fecha _____

Tema _____

- Repasa la información de cada categoría. Agrega algunos detalles o suprime información repetida, si es necesario.
- Elige un título informativo para tu informe y para cada categoría.

Para cada categoría:

- Lee toda la información en la categoría.
- Organiza la información en secciones.
- Decide lo más importante o interesante en orden de importancia (primero, segundo, etc).
- Nombra las secciones en orden, empezando por la información más importante.
- Prepara una introducción animada y cautivante para presentar tu tema.
- Prepara y usa apoyo visual (tablas, diagramas, fotografías) para atraer la atención de tu audiencia y para realizar tu presentación.
- Escribe los datos en tus propias palabras. Da ejemplos o agrega detalles para que tus párrafos sean más interesantes.
- Termina tu presentación de manera cautivante y con un final convincente.
- Repasa y corrige.
- Prepara un resumen en forma esquemática usando fichas para tu presentación oral.
- Usa accesorios o artefactos apropiados para tu presentación oral.
- Usa apoyo auditivo pertinente como música de fondo o efectos de sonido.

Lista de verificación para el informe: Presentación oral

(Adapted from Manitoba Education and Training, *Grades 5 to 8 English Language Arts: A Foundation for Implementation*, Grade 5 – 399)

Lista de verificación	
Nombre _____	Fecha _____
Título de la presentación _____	Código: C—lo demuestra de manera consistente S—lo demuestra a veces A—intenta demostrarlo N—necesita mejorarlo
Contenido El estudiante:	
<input type="checkbox"/> La presentación está bien organizada y tiene un orden lógico.	<input type="checkbox"/> La información es pertinente al tema
<input type="checkbox"/> Añade comentarios evaluativos	<input type="checkbox"/> Usa apoyo visual, gráfico, informativo, cuadros, diagramas y fotografías que cautivan a la audiencia y realizan la presentación
<input type="checkbox"/> Mantiene a la audiencia interesada	
Organización El estudiante:	
<input type="checkbox"/> Usa una introducción eficaz para atraer la atención de la audiencia	<input type="checkbox"/> Conoce bien el tema
<input type="checkbox"/> Presenta las ideas principales de una manera clara	<input type="checkbox"/> Amplia la información y ofrece detalles
<input type="checkbox"/> Se mantiene en el tema	<input type="checkbox"/> Mantiene el orden lógico
<input type="checkbox"/> Ofrece una conclusión eficaz	
Pragmática—Como el estudiante usa la lengua. El estudiante:	
<input type="checkbox"/> Usa volumen y énfasis apropiados	<input type="checkbox"/> Usa entonación apropiada
<input type="checkbox"/> Usa un ritmo apropiado	<input type="checkbox"/> Habla con oraciones completas
<input type="checkbox"/> Usa una variedad de estructuras de oraciones	<input type="checkbox"/> Usa tipos de oraciones variadas (frases imperativas y declarativas, preguntas, exclamaciones)
<input type="checkbox"/> Usa palabras descriptivas	<input type="checkbox"/> Usa vocabulario preciso relacionado al tema
<input type="checkbox"/> Explica el vocabulario que pueda ser desconocido para la audiencia	<input type="checkbox"/> Usa expresiones faciales apropiadas
<input type="checkbox"/> Demuestra el contacto visual culturalmente apropiado	<input type="checkbox"/> Usa gestos manuales apropiados
<input type="checkbox"/> Mantiene una postura apropiada	<input type="checkbox"/> Responde a preguntas con seguridad
<input type="checkbox"/> Amplía y explica las respuestas	
<input type="checkbox"/> Se relaciona bien con la audiencia	

Autoevaluación: Presentación oral

(Adapted from Manitoba Education and Training, *Grades 5 to 8 English Language Arts: A Foundation for Implementation*, Grade 5 – 398)

Nombre _____ Fecha _____

Título de mi presentación _____

	Marca uno	
1. Preparé un plan para mi presentación.	Sí	No
2. Preparé el plan yo mismo(a).	Sí	No
3. Preparé apuntes en forma esquemática.	Sí	No
4. Guardé mis fichas en un lugar específico.	Sí	No
5. Mi trabajo durante este proceso estuvo bien organizado.	Sí	No
6. Practiqué lo que iba a decir antes de presentar.	Sí	No
7. Incluí apoyo visual (tablas, fotos , artefactos, etc).	Sí	No
8. Usé apoyo auditivo (música, sonidos, etc).	Sí	No
9. Mi audiencia estaba interesada en mi presentación.	Sí	No
10. Mi audiencia escuchó atentamente a lo que decía.	Sí	No
11. Contesté las preguntas de la audiencia.	Sí	No
12. La mejor cosa de mi presentación fue _____ _____		
13. Una cosa que puedo mejorar la próxima vez es _____ _____		
14. Una cosa que haría nuevamente la próxima vez sería _____ _____		
15. En resumen, evaluaría mi presentación ... _____ _____		

Observación—Invitado(a)

Escala

Excelente		Bien		Poco satisfactorio
5	4	3	2	1

Cuando el invitado habla con su clase, observe que los estudiantes:

1. Hacen preguntas pertinentes
2. Escuchan atentamente al invitado
3. Hacen un esfuerzo para hablar en español

Nombre del estudiante																			
Hace preguntas pertinentes																			
Escucha atentamente al invitado																			
Hace un esfuerzo para hablar en español																			

Notes

Year 6: Sample Unit Current Issues

Sample Unit on Current Issues

Topic/Theme: Sucesos de actualidad	
Grade Level: Year 6	Task: Prepare and present a TV news broadcast about a current issue. Alternate Tasks: Prepare and present a mini debate, presenting possible solutions for a current issue studied.
<p>Analysis of language needs to complete task: Product: Vocabulary related to media-TV news: el/la presentador/a, el locutor, la emisión, emitir, transmitir, la emisión en directo, el tono de voz, la señal, el boletín de información, las noticias de actualidad internacionales/nacionales Newspapers: el editorial, la columna, las tiras cómicas, el suplemento, la primera página y otras. Process: Transition words: pues, quizás, por lo tanto. Connectors: pero, y, además. Words for sequence: primero, después, luego, al final. Vocabulary related to summaries: en este artículo, según este artículo, se dice que. Vocabulary to discuss how issues are presented: ¿Cuáles son los puntos de vista? ¿Podría ocurrir/suocer aquí? ¿Ha sucedido algo similar aquí? Expressions for debate: A mi me parece, estoy/no estoy de acuerdo, según mi opinión, disculpe, no me interrumpa, por favor, es mi turno, un momento.</p>	

General Outcomes

Applications (A)

Students will use Spanish in a variety of situations and for a variety of purposes

Language Competence (LC)

Students will use Spanish effectively and competently

Global Citizenship (GC)

Students will acquire the knowledge, attitudes, and skills to be effective global citizens

Strategies (S)

Students will know and use strategies to maximize the effectiveness of learning and communication

Specific Outcomes

The following specific outcomes are the focus of all or most of the instructional strategies described in the sample unit below:

Applications (A)

- share detailed information on a specific topic
- express opinions
- support own opinions

Language Competence (LC)

- speak clearly and intelligibly in a variety of situations
- select vocabulary and expressions from within their repertoire to fulfill a variety of purposes in a variety of contexts
- Aural Interpretation—understand the main point and some supporting details of lengthy texts on familiar topics in guided situations
- Oral Production—produce short texts on unfamiliar topics in guided situations
- Visual Interpretation—propose several interpretations of the visual elements in a variety of media in guided situations
- Representation—explore a variety of ways that meaning can be expressed through the visual elements of a variety of media in guided situations
- interpret and use a variety of non-verbal behaviours in a variety of contexts
- use appropriate words or phrases to show relationships in texts

Global Citizenship (GC)

- organize and represent information about elements of Spanish-speaking cultures in a variety of ways
- explore and identify some elements of Spanish-speaking cultures
- apply knowledge of elements of Spanish-speaking cultures derived from a variety of sources to interpret behaviours and texts

Strategies (S)

- evaluate the success of a variety of appropriate interpretive strategies to deal with specific communicative situations
- evaluate the success of appropriate metacognitive strategies to enhance general learning in specific situations

Specific Outcomes	Instructional Strategies	Assessment, Resources, Notes
<ul style="list-style-type: none"> • Use appropriate words and phrases to show relationships in texts • Share detailed information on specific topics • Evaluate the success of a variety of interpretive strategies to deal with specific communicative situations 	<p>1. a) Have students choose articles or provide three articles on current issues. Have students first read the text individually and highlight transition words, connectors, and words that help establish sequence. Students then work in partners to review the words found. Discuss findings as a class and put the key words on posters.</p> <p>b) Have students work in partners to summarize one article, using the Paragraph Frame as well as the outline for an issue-based article analysis provided on pages 83–85.</p> <p>c) Have students present summaries to the class. Have students also prepare two questions to ask classmates after summaries have been presented.</p>	<ul style="list-style-type: none"> • www.el-castellano.com • Checklist to Assess Attitudes and Values related to an Issue • Análisis de artículo basado en un asunto • Poster of key words—transition words, connectors, and words that help establish sequence • Paragraph frame/Estructura de párrafo • Rubric for Oral Summary
<ul style="list-style-type: none"> • Express and support opinions • Propose several interpretations of the visual elements use din a variety of media • Evaluate the success of appropriate metacognitive strategies to enhance general learning in specific situations 	<p>2. a) After summaries are presented, have students list current issues. In groups, have students choose one current issue that interests them. For two weeks, students must gather information from Spanish-speaking newspapers, magazines, etc. about their particular issue. One person in the group focuses on the history of the issue, one person examines the actual situation, and one person suggests possible solutions.</p> <p>b) Have students find a visual representation of the issue (picture, editorial, cartoon, ad, etc.). Have students propose several interpretations of the visual elements used.</p> <p>c) Have students discuss all the information found in their groups as well as keep a reflection journal in which they examine their learning process, how working in a group helped them, and what they found challenging.</p>	<ul style="list-style-type: none"> • Reflection Journal

Specific Outcomes	Instructional Strategies	Assessment, Resources, Notes
<ul style="list-style-type: none"> Explore and identify some elements of Spanish-speaking cultures Apply knowledge of elements of Spanish-speaking cultures derived from a variety of sources to interpret behaviours and texts 	<p>3. Have students view a news broadcast such as CNN en español.</p> <p>a) Working in small groups, have students mindmap the main issues presented and how the news is presented.</p> <p>b) Have students discuss how issues are presented in the broadcast:</p> <ul style="list-style-type: none"> What are the points of view? Could a particular issue/event occur in Canada? Why or why not? Has anything like this happened before? <p>c) How is reporting similar? Different?</p>	<ul style="list-style-type: none"> Mindmap Observation of Group Work Scoring Criteria for Collaboration
<ul style="list-style-type: none"> Oral Production— Produce short texts on unfamiliar topics Oral Production— Produce short texts on unfamiliar topics 	<p>4. Have students prepare a TV news broadcast about the issue for which they have collected information for two weeks, including information about the history, actual situation, and suggestions for solutions.</p> <p>Alternate Task: Have students work in groups to prepare a mini-debate. Each group presents the solutions they have created for the current issue that they studied for two weeks. Have one group of three students act as judges and choose the best solution of those presented. Change groups of judges regularly.</p>	<ul style="list-style-type: none"> ¡En español! 2, Unidad 5, Etapa 3 ¡En español! 3, Unidad 2, Etapa 1-3 ¡Buen Viaje! 3, Capítulo 5 Assessment—Rubric for News Broadcast <p>Assessment of group work—collaboration, participation, engagement in preparation of task</p> <ul style="list-style-type: none"> Daily Reflection on group participation Group assessment questionnaire Assessment—Rubric for Mini Debate
<ul style="list-style-type: none"> Use appropriate words and phrases to show relationships in texts 	<p>5. Provide students with appropriate expressions for a debate and discuss use of formal or informal register.</p>	

Unit Plan Outline	
Unit Focus: Current Issues	Grade Level(s): Year 6
Duration/Time Allotment	3 weeks
Lesson Topics	<ol style="list-style-type: none"> 1. <i>Introducción a los sucesos de actualidad, vocabulario</i> 2. <i>Representación visual de un suceso</i> 3. <i>Transmisión de noticias en español—Análisis</i> 4. <i>Preparación de una transmisión de noticias</i> 5. <i>Debate</i>
Spanish Language and Culture Outcomes	See Unit Planning Template, page 1.
<ul style="list-style-type: none"> ✦ General Outcomes ✦ Specific Outcomes (including linguistic content) 	<ol style="list-style-type: none"> 1. Share detailed information on specific topics 2. Propose several interpretations of elements in visual media 3. Explore and identify some elements of Spanish-speaking cultures
Curriculum Integration (if applicable)	<ol style="list-style-type: none"> 1. Generate ideas about current issues by referring to other subject areas—science, social studies, physical education, etc. 2. N/A 3. N/A
Planning for Learner Diversity	<ol style="list-style-type: none"> 1. Offer students of Spanish-speaking origins to focus their study on a particular country or event. 2. Ensure small groups are of mixed ability and cultural origins. 3. Offer an alternative exercise that focuses on radio broadcasts or an audio presentation for visually impaired students
Instructional Strategies/ Teaching Techniques	<ol style="list-style-type: none"> 1. Provide three articles on current issues. Read, highlight key words. Discuss findings with class. 2. Present techniques used in visual representation of an issue. Offer several examples, discuss as class.
Student Activities/Projects	<ol style="list-style-type: none"> 1. Students put key words from readings on posters. 2. Students must find visual representation of the issue and identify techniques to create message.
Resources	<ol style="list-style-type: none"> 1. www.el-castellano.com 2. pictures, editorial, cartoon, ad from Spanish newspapers, magazines 3. CNN <i>en español</i>—news broadcast
Assessment and Evaluation	<ol style="list-style-type: none"> 1. Observe student part in discussion 2. Reflection Journal 3. Mindmap Observation of Group Work Scoring Criteria for Collaboration

Lesson 1: Introducción a los sucesos de actualidad, vocabulario

Outcomes:

Use appropriate words and phrases to show a variety of relationships within texts.

Planning for Diversity:

Teacher selects pairs (strong/weak student)

Resources:

www.el-castellano.com

Method:

Have students choose articles or provide three articles of current issues. Have students first read the text individually and highlight transition words, connectors, and words that help students establish sequence. Students then work in partners to review the words found. Discuss findings as a class and put the key words on posters.

Assessment/Evaluation:

Poster key words—transition words (e.g., *pués, quizás, por lo tanto*), connectors (e.g., *pero, y, además*), and words that help establish sequence (e.g., *primero, después, luego, al final*).

Lista de verificación para evaluar actitudes y valores relacionados a un asunto

Tema _____ Fecha: _____

Nombres de los estudiantes	Leyó el material, miró la película/ escuchó al presentador o al casete	Participó activamente en la discusión en clase	Siguió la estructura para la discusión en clase	Expresó su opinión personal sobre el asunto	Respondió a las opiniones de otros estudiantes	Buscó más información sobre el asunto	Citó información para apoyar su posición	Demostró un desarrollo introspectivo de su posición personal	Defendió su posición	Aceptó crítica de su posición personal

Análisis de artículo basado en hechos

Note: The Fact-Based and Issued-Based Article Analysis sheets must be copied back-to-back. When you read the article, did it present a certain point of view about an issue under dispute? If so, use the other side of this sheet. If the article informed you but did not raise any concerns, use this side.

Concepto clave (escrito en una oración).

Dibuja una representación.

Escribe un resumen o definición en tus propias palabras. No nombres hechos. Da una perspectiva general.

Nombra tus preguntas (un mínimo de dos).

Nombra un mínimo de cinco palabras claves.

¿Cuáles son los hechos? Nombra un mínimo de cinco.

Pertinencia actual: Es importante o no es importante porque . . .

Análisis de artículo basado en un asunto

Note: The Fact-Based and Issued-Based Article Analysis sheets must be copied back-to-back. When you read the article did it inform you by presenting facts about a topic? If so, use the other side of this sheet. If the article presented a certain point of view about the issue under dispute, use this side.

Asunto (escrito como una pregunta).

Dibuja una representación.

Escribe un resumen en tus propias palabras (parafrasear).

Nombra tus preguntas (un mínimo de dos).

¿Qué opinas?

Importancia actual: Esto es importante o no es importante porque . . .

¿Qué opina el autor? Demuestra, prueba.

Estructura de párrafo

Título: _____

Frase preliminar _____

Primera frase informativa (comienza con una palabra de transición) _____

Frase siguiente (incluye más información sobre la primera frase informativa) _____

Segunda frase informativa (comienza con una palabra de transición) _____

Frase siguiente (incluye más información sobre la segunda frase informativa) _____

Tercera frase informativa (comienza con una palabra de transición) _____

Frase siguiente (incluye más información sobre la tercera frase) _____

Frase final (comienza con una palabra de transición) _____

Palabras de transición: Primero, Segundo, Tercer(o), Por la mañana, Por lo mismo, Por la tarde, Al principio, Después, Antes, Durante, Luego, Lo más importante, Al contrario, Otro ejemplo, Por ejemplo, Además, Mientras, Por consiguiente, De la misma manera, También ...

Palabras de transición para concluir: En resumen, Para concluir, Se ve que, Como resultado de, Por lo tanto, Entonces, En conclusión

Paragraph Frame: Adapted by permission of KU-CRL, Strategic Instruction Model, University of Kansas.

Evaluación: Póster

Miembros del grupo: _____

Criterios de evaluación:

5/5

- Se identifican todos los conectores y palabras que indican secuencia y transición
- Todas las palabras claves están organizadas lógicamente en el póster

4/5

- Se identifica la mayoría de los conectores y de las palabras que indican secuencia y transición
- En general, las palabras claves están organizadas en el póster, con algunas excepciones mínimas

3/5

- Se identifican algunos conectores y palabras que indican secuencia y transición. La lista no está completa.
- Se ha hecho un esfuerzo para organizar las palabras claves. Sin embargo, es posible que falten palabras o que estén organizadas bajo la categoría incorrecta.

2/5

- Se identifican pocos conectores y palabras que indican secuencia y transición.
- Se ha hecho poco esfuerzo para organizar las palabras claves. Es posible que varias palabras falten o estén organizadas bajo la categoría incorrecta.

1/5

- El trabajo está incompleto. Casi no se demuestra comprensión de las palabras claves. Las palabras clave no están organizadas en categorías.

0/5

- No hubo esfuerzo para hacer la tarea. Respuestas erróneas.

Hoja de evaluación: Resumen oral de un artículo

Nombre(s): _____

Criterio de evaluación para la presentación:

El estudiante:

5/5

- Habla correctamente y con habilidad y utiliza la lengua, el tono, el ritmo, el contacto visual y los gestos de manera persuasiva y con entusiasmo
- Está completamente preparado para que la presentación sea eficaz
- Utiliza palabras de transición, conectores y palabras que marcan la secuencia de manera eficaz
- Brinda información relevante
- Concluye de manera eficaz, de modo que crea el efecto deseado

4/5

- Habla correctamente y con fluidez y utiliza la lengua, el tono, el ritmo, el contacto visual y los gestos deliberadamente
- Está preparado de manera competente para inspirar confianza al presentar
- Utiliza varias palabras de transición, conectores y palabras que marcan la secuencia
- En general, brinda información relevante. Es posible que falten detalles mínimos o que sean innecesarios
- Concluye de manera eficaz

3/5

- Habla claramente, aunque con vacilación y utiliza la lengua, el tono, el contacto visual y los gestos para comunicarse de manera significativa
- Está preparado adecuadamente para que la presentación establezca un panorama básico
- Utiliza algunas palabras de transición, conectores y palabras que marcan la secuencia
- Brinda información relevante pero carece de detalles o son innecesarios
- Concluye adecuadamente

2/5

- Habla con vacilación y en general utiliza la lengua y el ritmo de manera ineficaz
- Fallas debido a falta de preparación
- Utiliza pocas palabras de transición, conectores y palabras que marcan la secuencia
- Brinda poca información relevante y carece de varios detalles
- Concluye con poca claridad

1/5

- No habla claramente, de manera que los oyentes tienen dificultad para comprender y utiliza la lengua y el ritmo de manera ineficaz
- En general, no está preparado
- No utiliza palabras de transición, conectores y palabras que marcan la secuencia
- Brinda muy poca información y carece de muchos detalles
- No concluye

Criterio de evaluación para la presentación

Nombre(s): _____

El estudiante:

5/5

- Habla correctamente y con habilidad y utiliza la lengua, el tono, el ritmo, el contacto visual y los gestos de manera persuasiva y con entusiasmo
- Está completamente preparado para que la presentación sea eficaz
- Utiliza palabras de transición, conectores y palabras que marcan la secuencia de manera eficaz
- Brinda información relevante
- Concluye de manera eficaz, de modo que crea el efecto deseado

4/5

- Habla correctamente y con fluidez y utiliza la lengua, el tono, el ritmo, el contacto visual y los gestos deliberadamente
- Está preparado de manera competente para inspirar confianza al presentar
- Utiliza varias palabras de transición, conectores y palabras que marcan la secuencia
- En general, brinda información relevante. Es posible que falten detalles mínimos o que sean innecesarios
- Concluye de manera eficaz

3/5

- Habla claramente, aunque con vacilación y utiliza la lengua, el tono, el contacto visual y los gestos para comunicarse de manera significativa
- Está preparado adecuadamente para que la presentación establezca un panorama básico
- Utiliza algunas palabras de transición, conectores y palabras que marcan la secuencia
- Brinda información relevante pero carece de detalles o son innecesarios
- Concluye adecuadamente

2/5

- Habla con vacilación y en general utiliza la lengua y el ritmo de manera ineficaz
- Falla debido a falta de preparación
- Utiliza pocas palabras de transición, conectores y palabras que marcan la secuencia
- Brinda poca información relevante y carece de varios detalles
- Concluye con poca claridad

1/5

- No habla claramente, de manera que los oyentes tienen dificultad para comprender y utiliza la lengua y el ritmo de manera ineficaz
- En general, no está preparado
- No utiliza palabras de transición, conectores y palabras que marcan la secuencia
- Brinda muy poca información y carece de muchos detalles
- No concluye

Diario de reflexiones—Sucesos de actualidad

1. ¿Qué comprendiste/aprendiste sobre el suceso de actualidad que estudiaste con tu grupo?
2. ¿Qué aprendiste sobre las técnicas que usan los medios de comunicación para crear un mensaje?
3. ¿Qué no comprendiste?
4. ¿Con qué punto estuviste de acuerdo? ¿Con qué puntos no estuviste de acuerdo?
5. a) ¿Cómo te ayudó el trabajo en grupo para comprender?
b) ¿Qué desafíos, si hubo alguno, encontraste al trabajar en tu grupo?
6. ¿Qué preguntas tienes todavía?
7. ¿Cómo puedes encontrar respuestas a tus preguntas?

Observación de trabajo en grupo

Cooperative Language: Write Observations focusing on students' use of cooperative language on self-stick notes for inclusion in the students' files or on a form such as the following, which lists the students' names across the top.

Hoja de observación													
Grupo: _____ Fecha: _____													
Marca cada vez que un estudiante usa lenguaje cooperativo.													
El estudiante													
Motiva													
Pide aclaración													
Mantiene al grupo en la tarea													
Expresa desacuerdo													

Criterios de evaluación para habilidades de cooperación

La siguiente norma de evaluación es un ejemplo de una norma de evaluación general para evaluar las habilidades de colaboración y las actitudes.

Criterios de evaluación para la colaboración	
Al evaluar la colaboración, considere <ul style="list-style-type: none"> • la actitud del estudiante por medio de su participación responsable y enfoque. • las habilidades del estudiante, evidente en el escuchar y contribuir a la discusión en grupo. • los roles que el estudiante asume para ayudar al desarrollo del grupo. 	
5	El estudiante <ul style="list-style-type: none"> • es un miembro eficaz, responsable, que inicia acción y se involucra en la tarea • escucha activamente, contribuye de una manera eficaz y construye sobre las ideas de otros • asume roles de liderazgo, da orientación, pide contribuciones, aclara y evalúa
4	El estudiante <ul style="list-style-type: none"> • es un miembro de grupo muy trabajador que es un participante activo y concentrado • escucha atentamente, contribuye de manera constructiva y emplea las ideas de otros • asume roles importantes, organiza y motiva a otros y aclara ideas
3	El estudiante <ul style="list-style-type: none"> • es un miembro de grupo atento, cooperativo y que aporta al grupo • escucha, respeta las ideas de otros y ayuda al grupo a tomar decisiones • asume roles de apoyo, se involucra al grupo, pero muy raras veces como líder
2	El estudiante <ul style="list-style-type: none"> • es a menudo un observador y puede distraerse de la tarea • escucha al principio, pero pierde enfoque o limita el enfoque a ideas personales • asume roles de apoyo esporádicamente
1	El estudiante <ul style="list-style-type: none"> • generalmente no se involucra al grupo, y puede distraer a los otros o crear conflicto • está tan enfocado en sus perspectivas personales, que cuando escucha se enfoca en las diferencias • casi nunca asume roles constructivos
Insuficiente	El estudiante <ul style="list-style-type: none"> • no hace ningún esfuerzo para trabajar con otros

Scoring Criteria for Collaboration: Copyright © 1997 *English 10: Teacher Manual: Classroom Assessment Materials*, Alberta Education.

Hoja de evaluación: Programa de televisión o radio

Criterios de evaluación para el programa de televisión

5/5

Contenido

- La información es pertinente, con muchos detalles importantes e interesantes
- El programa está organizado lógicamente o en forma creativa
- El vocabulario y las expresiones específicos están integrados de manera eficaz en el programa
- Se nota que hubo preparación detallada
- Se utiliza apoyo visual de manera eficaz

Presentación

- Se habla con claridad
- La pronunciación es correcta
- Se habla de manera fluida

4/5

Contenido

- El material es pertinente con algunos detalles importantes e interesantes
- El programa está organizado lógicamente, en cierta forma creativa
- El vocabulario y las expresiones específicos están generalmente integrados en el programa, es posible que haya errores u omisiones mínimos
- Se nota que hubo una buena preparación
- El apoyo visual es apropiado y agrega valor a la presentación

Presentación

- En general, se habla con claridad
- En general, la pronunciación es correcta aunque es posible que no se pronuncien correctamente las palabras difíciles o no conocidas
- Se habla con cierta fluidez pero con posible vacilación mínima

3/5

Contenido

- La información es mayormente pertinente, puede carecer de detalles importantes e interesantes
- En general, el programa está bien organizado, pero puede carecer de creatividad
- Se ha hecho un esfuerzo para integrar el vocabulario y las expresiones específicos, hay errores u omisiones
- Se nota que hubo preparación, pero algunas partes del programa pueden parecer desorganizadas o incompletas
- Se utiliza apoyo visual, pero es insuficiente o inapropiado

Presentación

- Algunas palabras no son claras
- Algunas palabras no se pronuncian correctamente
- Se habla con cierta lentitud

2/5

Contenido

- Varios aspectos de la información no son pertinentes, carece de muchos detalles importantes e interesantes
- El programa está organizado sólo en ciertas partes, pero carece de creatividad
- Se ha hecho poco esfuerzo para integrar el vocabulario y las expresiones específicas, hay muchos errores u omisiones
- Preparación mínima
- Se utiliza poco apoyo visual y de manera ineficaz

Presentación

- No se habla con mucha claridad
- Muchas palabras no se pronuncian bien
- En general, se habla con demasiada lentitud o demasiada rapidez

1/5

Contenido

- La información no es pertinente y es inapropiada
- El programa carece de organización, estructura y creatividad
- No se ha hecho esfuerzo para integrar el vocabulario y las expresiones específicas
- Carece de preparación
- El apoyo visual es mínimo o inexistente

Presentación

- La mayoría de las palabras no son claras
- La mayoría de las palabras no se pronuncian correctamente
- Se habla con demasiada lentitud o demasiada rapidez

Hoja de evaluación: Debate

Criterios de evaluación para el debate

5/5

Contenido

- La información es correcta, detallada y convincente
- El vocabulario y las expresiones específicos están integrados de manera efectiva en el debate
- El lenguaje/registro formal es utilizado correctamente y de manera eficaz
- Se nota que hubo preparación detallada

Presentación

- Se habla con claridad
- La pronunciación es correcta
- Se habla de manera fluida

4/5

Contenido

- La información es correcta, con algunos detalles importantes y convincentes
- El vocabulario y las expresiones específicos están generalmente integrados en el debate, es posible que haya errores u omisiones mínimos
- En general, el lenguaje/registro formal es utilizado correctamente aunque pueden haber errores u omisiones mínimos
- Se nota que hubo una buena preparación

Presentación

- En general, se habla con claridad
- En general, la pronunciación es correcta, es posible que no se pronuncien correctamente las palabras difíciles o no conocidas
- Se habla con cierta fluidez pero con mínima vacilación

3/5

Contenido

- La información es mayormente pertinente, puede carecer de detalles importantes
- En general, el debate está bien organizado, pero no es muy convincente
- Se ha hecho un esfuerzo para integrar el vocabulario y las expresiones específicos, hay errores u omisiones
- Se ha hecho un esfuerzo para utilizar lenguaje/registro formal, hay errores
- Se nota que hubo preparación, pero algunas partes del debate pueden parecer desorganizadas o incompletas

Presentación

- Algunas palabras no son claras
- Algunas palabras no se pronuncian correctamente
- Se habla con demasiada lentitud

2/5

Contenido

- Varios aspectos de la información no son pertinentes, carece de muchos detalles importantes
- El debate está organizado sólo en ciertas partes
- Se ha hecho poco esfuerzo para integrar el vocabulario y las expresiones específicos, hay muchos errores u omisiones
- Se ha hecho poco esfuerzo para utilizar lenguaje/registro formal de manera correcta
- Preparación mínima

Presentación

- No se habla con mucha claridad
- Muchas palabras no se pronuncian bien
- En general, se habla con demasiada lentitud o demasiada rapidez

1/5

Contenido

- La información no es pertinente y es inapropiada
- El debate carece de organización y de estructura
- No se ha hecho esfuerzo para integrar el vocabulario y las expresiones específicos
- No se ha hecho esfuerzo para utilizar lenguaje/registro formal de manera correcta
- Carece de preparación

Presentación

- La mayoría de las palabras no son claras
- La mayoría de las palabras no se pronuncian correctamente
- Se habla con demasiada lentitud o demasiada rapidez

Cuestionario: Evaluación de grupo

1. ¿Nos pusimos de acuerdo como grupo al tomar decisiones?
2. ¿Respetamos los enfoques y habilidades de cada miembro del grupo?
3. ¿Invitamos a los miembros a desarrollar un nuevo papel?
4. ¿Cómo tratamos el problema de la ausencia o la falta de participación de los miembros?
5. ¿Usamos nuestro tiempo de manera eficaz?
6. ¿Hablamos abiertamente de nuestras inquietudes en lugar de dejar aumentar la tensión?
7. ¿Pedimos ayuda de otros cuando no pudimos ponernos de acuerdo?
8. ¿Qué debilidades en nuestro producto final podrían haber sido discutidas por medio de un proceso de grupo diferente?
9. ¿Qué teníamos que haber hecho más, menos?
10. ¿Nuestro producto final logra representar las habilidades y talentos de cada miembro del grupo?

Notes

APPENDICES

Appendix A: Glossary	3
Appendix B: Sample List of Text Forms	11
Appendix C: Annotated List of Spanish Language and Culture Websites	13
Appendix D: Areas of Experience	31
Appendix E: Global List of Strategies	33

APPENDIX A: GLOSSARY

Authentic Situations

These refer to real-life situations one would encounter in a Spanish-speaking community (e.g., in a bakery, store, restaurant, etc.).

Cohesion and Coherence

Cohesion and coherence are two important elements of discourse. Cohesion in a discourse sequence is created by many words or phrases that link one part of the text to another. Coherence is more concerned with the large structure of texts: a single theme or topic, the sequencing or ordering of the sentences, the organizational pattern (temporal sequencing, cause and effect, condition and result, etc.). Texts that are cohesive and coherent are easier to interpret.

Content-Based Language Learning

In content-based language learning, students learn a second language while they are learning content from another subject area. This is the approach taken in bilingual programming.

Cornell Notes

“Cornell notes” is a form of note-taking that helps students organize their notes regarding a presentation or reading task, identify key words and concepts, and find important information quickly.

The Cornell note-taking technique simply divides a page into the following:

- Left column (approximately 1/3 of the page): main ideas
- Right column (approximately 2/3 of the page): details
- Bottom (approximately 1/5 of the bottom of the page): summary

This strategy may be used to:

- Outline an article, an entire text, or a chapter in a text.
- Take notes on a lecture or presentation.

Culture

The members of the culture task force of the *National Core French Study* (LeBlanc) have defined culture as “the general context and way of life. It is the behaviors and beliefs of a community of people whose history, geography, institutions, and commonalities are distinct and distinguish them to a greater or lesser degree from all other groups.”

Historical and contemporary elements of the culture may include historical and contemporary events, significant individuals, emblems or markers of national identity (myths, cultural products, significant sites, events in the collective memory), public institutions, geographical space (regions, landmarks, borders, frontiers), social distinctions, conventions of behaviour, beliefs, perceptions, and perspectives.

Discourse

Discourse is connected speech or writing that extends beyond a single sentence or utterance.

Discourse Features

The term “discourse” refers to the organization of language in units greater than the sentence. Although this is a complex topic involving many aspects of language, teachers need be concerned for the most part about only three kinds of discourse features: **rhetorical organization, discourse markers, and theme-rheme structure.**

Rhetorical organization refers to the way stretches of text larger than the sentence are constructed. The classic example is paragraph structure, often recommended to be the following: topic sentence → supporting details → concluding sentence. Other examples are textbook organization, the structure of friendly letters and business letters, the format of science experiment reports, and the organization of essays (descriptive, expository, etc.) and narratives.

Discourse markers are used to achieve textual cohesion. Terms like *nevertheless, in spite of, consequently, therefore, in contrast to, in comparison to, and on the other hand* are infrequent in every day communication, so students need to be taught their meanings and the proper grammatical usage.

Theme-rheme structure refers to the organization of information with sentences. From the point of view of information organization, most sentences consist of two distinct parts:

- a) the topic, or what is being talked about. Some linguists call this the theme of the sentence. It is followed by—
- b) the comment, or what is said about the theme. This is often called the rheme of the sentence.

For example, consider the following discourse. Mary: “Where’s your brother?” Bill: “He’s in the shower.” In Bill’s response, “he” is the theme (what is being talked about), while “(s) in the shower” is the rheme (what is said about “he”). Notice that in normal discourse the theme typically consists of “given” information, whereas the rheme is usually “new” information. In students’ answers to written questions like “What is a meteorologist?”, the

response would be “A meteorologist (theme—given information—comes first) is a person who studies the weather (rheme—new information—follows theme).”

Diverse, Diversity

Within most cultures, there are groups of people who have cultural beliefs, values, and practices that are different from the majority or mainstream culture. These differences may be based on religion, national or ethnic origin, social class, race, or colour.

Exploratory Language

Exploratory language is language used to explore the thoughts, ideas, opinions, etc. of oneself or others. Examples of exploratory language include the following: What if...? How? I wonder...

I-Charts (Inquiry/Information Charts)

What Is An I-Chart? An I-Chart is a note-taking strategy that guides students in selecting and organizing relevant information from reference material. I-Charts offer a planned framework for examining critical questions by integrating what is already known or thought about the topic with additional information found in several sources. The strengths of an I-Chart include the following:

- Organizes information from several sources easily
- Organizes subtopics based on student questions which were developed from their own prior knowledge
- Provides consistent organization
- Provides ongoing process of critical evaluation by the student

How Does It Work? In creating an I-Chart for a given topic, students will have several questions to explore. These are found at the top of each individual column of the chart. The rows are for recording, in summary form, the information students think they already know and the key ideas pulled from several different sources of information. The final row gives them a chance to pull together the ideas into a general summary. At this point students will also try to resolve competing ideas found in the separate sources and develop new questions to explore based on any conflicting or incomplete information.

How Does It Look, Generally? The I-Chart that appears below is a sample. Teachers and students can create for themselves I-Charts to help analyze several sources of information. Teachers and students should feel free to modify the charts to meet their needs.

	Question Area 1 <i>Pregunta área 1</i>	Question Area 2 <i>Pregunta área 2</i>	Question Area 3 <i>Pregunta área 3</i>	Question Area 4 <i>Pregunta área 4</i>
What I think/ <i>Lo que pienso</i>				
Source #1/ <i>Fuente #1</i>				
Source #2/ <i>Fuente #2</i>				
Source #3 <i>Fuente #3</i>				
Summary/ <i>Resumen</i>				

Idiomatic Expression

An idiom or an idiomatic expression is a word or group of words that is used in a particular language that has a commonly accepted meaning that is not the literal meaning and does not follow regular grammatical usage. Some examples are *happy as a lark* (very happy), and *I'm fed up* (I've had enough, I'm disgusted, bored).

Independent Situations

This term is used to describe learning situations where students use specific linguistic elements in a variety of contexts with limited teacher guidance. Students in such situations will have consistent control of the linguistic elements and be able to apply them in a variety of contexts with limited teacher guidance. Fluency and confidence characterize student language.

K-W-L (SQA)

K-W-L is the creation of a 3-column chart that helps capture the Before, During, and After components of a particular learning event or task. It helps students to activate their prior knowledge, plan for or think about what knowledge they want to acquire, and reflect on what they have learned as a result of their engagement in the learning activity or task.

- **K** stands for **Know**
What do I already know about this topic?
- **W** stands for **Will** or **Want**
What do I think I will learn about this topic?
What do I want to know about this topic?
- **L** stands for **Learned**
What have I learned about this topic?

How Does It Work?

1. On the chalkboard, on an overhead, on a handout, or on students' individual clean sheets, three columns should be drawn.
2. Label Column 1 K, Column 2 W, Column 3 L.
3. Before the task or learning activity, students fill in the Know column with everything they already know about the topic. This helps generate their background knowledge.
4. Then have students predict what they might learn about the topic, which might follow a quick glance at the resources or materials which they may be using for the activity/task. This helps set their purpose for reading and focuses their attention on key ideas.
5. Alternatively, you might have students put in the middle column what they want to learn about the topic.
6. After reading, students should fill in their new knowledge gained from the learning activity/task. They can also clear up misperceptions about the topic which might have shown up in the Know column before they actually engaged in the learning activity/task. This is the stage of metacognition: did they get it or not?

Language Learning Strategies

These are actions taken by learners to enhance their learning.

Cognitive strategies operate directly on the language and include such things as using different techniques for remembering new words and phrases, deducing grammar rules or applying rules already learned, guessing at the meaning of unknown words, or using different ways to organize new information and link it to previously learned language.

Metacognitive strategies are higher order skills that students use to manage their own learning. They include planning for, monitoring, and evaluating the success of language learning.

Social strategies are actions learners take in order to interact with other learners or with speakers of Spanish.

Affective strategies are methods learners use to regulate their emotions, motivation, and attitudes to make them more conducive to learning.

Language Use Strategies

These are actions taken to enhance communication. The strategies in the curriculum are organized according to the three communicative modes: interaction, interpretation, and production.

Language use strategies can be seen as a sub-category of language learning strategies since any action taken to enhance communication or to avoid communication breakdown can be seen as increasing the chances that language learning will take place. Language use strategies can, however, be used with no intention of trying to learn the language better.

Lexicon

Lexicon covers all kinds of words, both content words (e.g., *dog, run, happy*) and function words (e.g., *him, from, but*). It also includes lexical phrases, which are groups of words that function like a single word (e.g., *all of a sudden*).

Mechanical Features

These are the conventions used to make written text easier to read. They include such things as capitalization, punctuation, paragraphs, titles, or headings.

Modelled Situations

The term is used in the specific learning outcomes to describe distinct situations in which students may be supported to produce speech or use language. Modelled situations include the provision of a language model that can be directly imitated (such as "Hello!" "Hello!") or situations in which a small part of the modelled phrase can be changed or manipulated following a pattern (such as "I like pizza." "I like spaghetti.").

Morphology

Morphology is the part of grammar that deals with changes in words that mark their function in the sentence (e.g., changes in verb endings or adjectives to mark agreement).

Non-verbal Communication

A large part of what we communicate is done without the use of words. Meaning can be communicated by gestures, eye contact, facial expressions, body language, physical distance, touching, as well as by sounds, noises, and silence.

Register

Register is the level of formality of speech or writing based on the social context in which the language is used. Casual conversation uses an informal register while situations like a public lecture or a radio broadcast demand a more formal register. The language used in a personal letter to a good friend or a close family member differs considerably from a formal letter in the business world.

Social Conventions

These are the customs that accompany speech in social situations. They include actions such as bowing, shaking hands, or kissing; topics that are taboo in conversation; conventions for turn-taking and interrupting or refusing politely; and appropriate amounts of silence before responding.

Structured Situations

This term is used in the specific learning outcomes to describe how teachers and other helpful conversational partners use methods tailored to help second language learners understand and produce language.

Oral language is more easily understood if speech is slow and clearly articulated with pauses to assimilate meaning and if it is accompanied by gestures, facial expressions, body language, or visuals, which help to express the meaning. Language learners will have less difficulty understanding a familiar speaker (one whose voice, accent, and speech habits are well-known to them) speaking about a topic that they know well and are interested in.

Written language is more easily understood if, for example, there are illustrations to support the text, titles and sub-titles to guide the reader, and the topic is a familiar one.

Both oral and written production can be structured by providing students with language models (e.g., sample sentence structures, text forms, patterns of social interaction) and a language-rich environment (e.g., illustrated thematic vocabulary lists on classroom walls, labels on classroom objects, correction guides, illustrated dictionaries). As students become more proficient, these supports can gradually be removed until the language they are exposed to closely resembles language in authentic situations.

Task-Based Language Learning

In task-based language learning, classes are structured around meaningful tasks rather than around elements of the language itself, such as grammar structures, vocabulary themes, or language functions.

Text

Any connected piece of language, whether spoken utterance or a piece of writing, which language users/learners interpret, produce, or exchange. There can thus be no act of communication through language without a text.

Text Forms

Different kinds of texts have typical structures. A letter, for example, has a different form or structure than a report or a poem. An oral interview is different from an announcement or an oral presentation. A sample list of text forms can be found in Appendix B.

Unstructured Situation

A situation in which vocabulary, grammatical structures, speed of delivery, and the like are not tailored for the second language learner; rather, the oral or written text is geared toward the Spanish-speaking culture, as would be found on authentic radio or television and in authentic print materials.

Variations in Language

Within any language, there are variations in the way people speak and write. Language can vary with the age, gender, social class, level of education, and occupation of the speaker. It can also vary from region to region within a country. Variations include differences in accent, vocabulary, and sometimes syntax as well as different social conventions.

APPENDIX B: SAMPLE LIST OF TEXT FORMS

Written Texts

- Advertisements
- Biographies and autobiographies
- Brochures, pamphlets, and leaflets
- Catalogues
- Dictionary and grammar items
- Encyclopedia entries
- Folk tales and legends
- Forms
- Graffiti
- Instructions and other “how to” texts
- Invitations
- Journals, diaries, and logs
- Labels and packaging
- Letters (business and personal)
- Lists, notes, and personal messages
- Maps
- Menus
- Newspaper and magazine articles
- Plays
- Poetry
- Programs
- Questionnaires
- Recipes
- Reports and manuals
- Short stories and novels
- Signs, notices, and announcements
- Stories
- Textbook articles
- Tickets, timetables, and schedules

Oral Texts

- Advertisements
- Announcements
- Ceremonies (religious and secular)
- Debates
- Formal and informal conversations
- Interviews
- Lectures
- Messages
- Oral stories and histories
- Plays and other performances
- Reports and presentations
- Songs and hymns
- Telephone conversations

Multimedia Texts

- Comic strips
- Computer and board games
- Movies and films
- Slide/tape and video presentations
- TV programs
- Websites

APPENDIX C: ANNOTATED LIST OF SPANISH LANGUAGE AND CULTURE WEBSITES

The World Wide Web is a wonderful but complex resource that has much potential to support and enhance the classroom experiences of international language learners and to assist teachers in accessing resources and information as needed.

The websites and resources listed and described in this bibliography have been chosen because they have been identified by teachers as complementing and supporting the implementation of the Spanish Language and Culture curricula. Many of the websites listed are rich in resources and have many “layers.” Thus, they can be “mined” extensively and may be useful for many purposes and learning activities. Teachers should take the time to become familiar with each site and explore all its dimensions and resources.

The websites included in the bibliography have been sorted into a few broad categories, which complement the curriculum and suggested areas of experience for various grade levels. However, many sites could be listed under several categories. To avoid redundancy, we have elected to list websites only once in the bibliography, except where a particular page or section of the website is particularly relevant to an important or essential aspect of the curriculum.

In some cases, websites have been selected as examples of what is available on the Internet for classroom or self-study purposes.

General-Multi-Faceted Resource Sites

➤ ***BBC Languages, Spanish Homepage:***

<<http://www.bbc.co.uk/languages/spanish/>>

The Spanish home page of the BBC languages website offers many resources for teachers and students. Video clips and other exercises related to the three BBC Spanish courses (*Sueños*, *Spanish Steps*, and *Talk Spanish*) are available. Video clips for viewing and listening to a variety of native speakers in various contexts and Hispanic countries related to all three courses are available. The site also offers news and travel information for learners of Spanish.

➤ ***Embajada de España en Canadá:***

<<http://www.docuweb.ca/SpainInCanada/spanish/index.html>>

The embassy website has information on teaching Spanish, as well as photos and information on Spanish history, language, and culture. The education office provides links to useful websites and information on exchanges, bursaries, instructional sites, and teacher training opportunities.

➤ ***Español enlaces:***

<<http://www.mesalibrary.org/espanol/enlaces.htm>>

The City of Mesa library website offers a list of selected websites with resources for a variety of themes and areas of interest. This is a rich website with great links to art, music, and theatre sites for different Spanish-speaking countries.

➤ ***La Casa de Joanna: Spanish Resources:***

<http://members.aol.com/jporvin/cs_span.htm#cult>

This is a general teacher's resource page for teaching Spanish. Sample unit and lesson plans, links to resources by themes, and information on media and news sites are all available.

➤ ***Languages Other Than English (LOTE): Center for Educator Development (CED):***

<<http://www.sedl.org/loteced/welcome.html>>

This site was developed to support K-12 teachers in Texas, specifically those who teach languages other than English. The site features an array of informational and instructional resources. Some of the features of the site that teachers will find attractive are assessment resources and sample rubrics, "learning scenarios" (sample unit plans) organized by language and theme, and links to other foreign/international language sites.

➤ ***Latin American Network Information Center—LANIC:***

<<http://lanic.utexas.edu/>>

The Latin American Network Information Center is affiliated with the Lozano Long Institute of Latin American Studies at the University of Texas at Austin. LANIC's mission is to facilitate access to Internet-based information to, from, or on Latin America. Their target audience includes people living in Latin America, as well as those around the world who have an interest in this region. While many of the resources are designed to facilitate research and academic endeavours, the site is also an important gateway to Latin America for primary and secondary school teachers and students. This site offers links to some excellent sites based on broad themes/categories.

➤ ***Latin World:***

<http://www.latinworld.com/index.html>

This is a good portal for accessing resources related to the Latin-speaking world. This is a multilingual site utilizing Spanish, Portuguese, and English.

- ***Ninos + Internet = Kokone:***
<<http://www.kokone.com.mx/menu.html>>
This award-winning children’s Spanish educational site offers readings, games, and fun interactive learning activities. The resources found here may be adapted for middle years and secondary learners of Spanish.
- ***Primera Escuela:***
<<http://www.primeraescuela.com/>>
This site provides learning activities and ideas intended for young children learning Spanish. However, some of the resources and ideas could be adapted for older beginning students.
- ***Si, Spain:***
<<http://www.sispain.org/spanish/index.html>>
This website offers information and resources about Spain.
- ***Spanish Language Resources:***
<<http://polyglot.lss.wisc.edu/lss/lang/spanish.html>>
This resource page, maintained by the University of Wisconsin, provides links to Spanish language materials organized by themes such as Culture and History, City Tours, Literature and Language, News, and Magazines.
- ***SpanishLinx—Home Page:***
<http://sikuani.its.monash.edu.au/spanishlinx/index.html>
This is an excellent website by the teachers of Spanish in the State of Victoria, Australia. A range of resources are available, including teacher resources, links to web pages in Spanish, a list of learning resources, and reference material related to a number of themes.
- ***Spanish—University of Manitoba:***
<<http://www.umanitoba.ca/fsi/spanish/fsispan.htm>>
The Spanish web page of the University of Manitoba, Department of French, Spanish and Italian offers useful resources for teachers, including Spanish resources in Manitoba.
- ***Super Spanish Web Sites:***
<<http://www.uni.edu/becker/Spanish.html>>
This site identifying Spanish websites was developed by Professor Becker at the University of Northern Iowa.
- ***University of Minnesota, Centre for Advanced Research on Language Acquisition (CARLA)***
<<http://www.carla.acad.umn.edu/IS-resources.html>>
This excellent web page provides a brief description of various cross-cultural simulation games and exercises, including Bafa Bafa.

Arts and Literature

Artists, Museums, and Virtual Galleries

➤ ***Artcyclopedia: The Fine Arts Search Engine:***

<<http://www.artcyclopedia.com/>>

This site offers a search engine with links to information, biographies, and images of works of art from over 3000 artists. Information and resources for artists such as Pablo Picasso, Frida Kahlo, Francisco Goya, and many others may be found. The site also provides links to galleries worldwide.

➤ ***ArteHistoria:***

<<http://www.artehistoria.com/>>

This site features information on important historical events and art from various periods.

➤ ***El arte en el mundo hispano:***

<<http://www.usc.edu/dept/spanish/BLP/resources/art.html>>

Information and links to artists and galleries are available on this site, organized by country.

➤ ***El museo Dolores Olmedo Patiño:***

<<http://www.arts-history.mx/museos/mdo/museo.html>>

The museum Dolores Olmedo Patiño in México is dedicated to the preservation and promotion of the largest private collection of the work of Diego Rivera, integrated with 137 works of the muralist and painter, 25 works of art by Frida Kahlo, and 43 creations of Angelina Beloff. The gallery also features an extensive collection of over 600 pieces of pre-Hispanic works of diverse indigenous cultures of the country, and antiques and popular art pieces (ceramic, glass, masks, etc.). The site features a brief introduction to the featured artists and major collections and provides images of a number of pieces in each collection.

➤ ***Galeria Virtual Espartaco:***

<<http://www.proyectoartaco.com/galeria/index.php>>

This site is a “virtual” gallery of various artists, including their biographies and links to related pieces or artists. Examples of some of the artists featured are Salvador Dali, Frida Kahlo, Diego Rivera, and Pablo Picasso.

➤ ***Museo Nacional del Prado:***

<<http://museoprado.mcu.es/>>

Spain’s most important museum holds an extensive art collection. The site offers a presentation of the museum’s history, general information about it, and virtual visits. Masterpieces are presented with explanations and artists’ biographies for artists such as El Greco.

Biographies➤ ***Buscabiografias:***

<<http://www.buscabiografias.com/>>

This site offers biographies on a large number of famous Spanish-speaking people and other personalities from around the world.

Literature and Poetry➤ ***Bibliotecas Virtuales—Comunida Literaria y Textos en Línea:***

<<http://www.bibliotecasvirtuales.com/>>

Through the web pages that comprise this site, one can electronically access a carefully selected and constantly growing array of complete texts of the works of some of the most well-known writers in the world, with an emphasis on Ibero-American writers and on the Spanish language. The virtual “stands” on this site present novels, stories, plays, essays, articles, fables, poetry, legends, and general texts of Dominican, Argentinean, Spanish, and other writers, as well as authors’ biographical information. The site also offers a variety of interactive resources, including a discussion forum.

➤ ***Ciberayllu:***

<<http://www.andes.missouri.edu/andes/ciberayllu.shtml>>

This website was founded by a group of Peruvian writers interested in sharing their writings with the world. The site features excerpts and works on many themes from a variety of writers.

➤ ***Imaginaria—Revista de Literatura Infantil y Juvenil:***

<<http://www.imaginaria.com.ar/>>

This site provides information about authors and about fables and fairytales of the Spanish-speaking world.

➤ ***La Pagina del Idioma Español:***

<<http://www.elcastellano.org/literatu.html>>

This website is dedicated to the Spanish language (Castilian). The site offers information resources and links related to all aspects of Spanish.

➤ ***Literatura Argentina Contemporánea:***

<<http://www.literatura.org/>>

This site celebrates writers and writing. Contemporary Argentinean writers and excerpts of their works are featured on this site.

➤ ***Poesía Latinoamericana:***

<<http://members.tripod.com/~poesialat/poetas.html>>

This site features a list of famous Latin American poets and links to examples of their work.

➤ **Poesías—Menú de autores:**

<<http://luis.salas.net/index02.htm>>

This site provides an indexed list of authors and their works (poems and short stories). Visitors to the site may choose pieces by author or by era. The site offers a great variety of links to specific pieces of writing, authors, etc. See also: <<http://www.poesia-inter.net/enlaces.htm>>.

➤ **Proyecto Sherezade:**

<<http://home.cc.umanitoba.ca/~fernand4/>>

Proyecto Sherezade is an initiative launched in 1996 at the University of Manitoba to promote the interchange of narratives and stories of Spanish authors. More than 150 published short stories of authors representing 25 Hispanic countries are available on this website. Interactive stories with exercises are provided. The site is refreshed on a regular basis with new stories listed monthly.

Legends and Fables

➤ **Folk Legends, Tales and Fables: Creating and Reflecting Community—(LOTE)**

<http://www.sedl.org/loteced/scenarios/spanish_legends.html>

This page, from the LOTE website listed earlier, offers a “Learning Scenario” (sample unit) in which students read a selection of Spanish-language folk legends from a variety of countries. Folk legends were and are used as a method of communicating ideas, beliefs, or unexplained events that give a community its particular identity. The unit demonstrates how the global citizenship outcomes and language competence outcomes may be combined in an interesting unit for intermediate learners of Spanish.

➤ **Hadaluna lee:**

<<http://pagina.de/hadaluna>>

This website features stories, legends, classic tales, and fables from the Spanish-speaking world and other cultures. It is an attractive site with a multicultural flair and with links to other related websites.

➤ **Las Fábulas de Esopo:**

<<http://www.edyd.com/Fabulas/Esopo/Eindice.htm>>

This educational site provides an index and links to over 300 Esopo (Aesop) fables in Spanish. The main page offers “cuentos” (stories) in Spanish by Dr. O. Morales. (Also see **Biblioteca Virtuales**.)

➤ **Leyendas mexicanas:**

<<http://www.mexico.udg.mx/historia/leyendas/>>

This site features Mexican colonial and pre-Hispanic legends.

➤ ***Página para niños:***

<http://www.agn.gob.mx/agn_ninos/arriba.html>

This children's website features, among other resources, animated stories, fables, and legends.

Comics and Animation

➤ ***Al's Mafalda Page:***

<<http://www.turning-pages.com/mafalda/>>

This site is dedicated to Argentine cartoonist Quino's famous Mafalda character, icons, books, and commentaries. It is not the official Quino site.

➤ ***La página oficial de Quino:***

<<http://www.clubcultura.com/clubhumor/quino/espanol/trabajos.htm>>

The official web site of the Argentine cartoonist Quino, featuring his works (Mafalda and other characters) and aspects of his life.

➤ ***Oso Tranqui:***

<<http://users.servicios.retecal.es/mgosalvez/index.html>>

This site is dedicated to comics and animation. It offers links to specific comics sites as well as information on the history of comics. Caution: Some of the comics and themes may not be appropriate for classroom use. Teachers should preview comics and sites carefully.

Cuisine—Food

➤ ***A Tapear!:***

<<http://www.atapear.com/>>

This website is dedicated to the world of "Tapas." It offers information on the history of Tapas and a variety of recipes.

➤ ***Cocina Colombiana:***

<<http://www.members.tripod.com/~cpino/cocina.htm>>

The site offers recipes for the "best" of Colombian dishes.

➤ ***La Recetas de Marita:***

<<http://www.acocinar.com/recetas.htm>>

This website features recipes and photos of Marita's favourite Spanish and Mediterranean dishes. Links to other gastronomically focused sites are available.

➤ ***Recetas Navideñas:***

<<http://teletline.terra.es/personal/7sietes/recetas.htm>>

This site features traditional Christmas recipes from Spain. Other pages on this site offer Spanish Christmas music and images.

Cultural Celebrations and Traditions

- ***Casa de Porvin: Día los Muertos 2003:***
<http://members.aol.com/jporvin/cs_muer.htm>
This website is dedicated to language learning resources. It features a unit plan for learning about the “Día de los muertos,” class activities, handouts, images, and examples of student projects.
- ***Cinco de mayo webquest:***
<<http://www.zianet.com/cjcox/edutech4learning/cinco.html>>
This site is a complete Internet-based unit plan focusing on Cinco de mayo. The unit was developed for young children but may easily be adapted for older students. Learning tasks, resources, and rubrics related to the cultural celebration Cinco de mayo are provided.
- ***La Lotería:***
<<http://nmaa-ryder.si.edu/webzine/loterial.htm>>
This site provides a description of and resources for a lesson based on a Mexican game. In this lesson, students play a traditional game of Mexico and use the artwork from the gamecards to create an original artwork.
- ***La Navidad Latina:***
<<http://www.navidadlatina.com/index.asp>>
This Latin American Christmas website provides many useful resources ranging from Christmas songs and lyrics, traditional recipes, children’s letters to Santa, and stories to some Christmas-focused games such as crossword puzzles.
- ***Navidad Digital.com:***
<<http://www.navidaddigital.com/>>
This site features everything about Christmas from a Spanish perspective. Christmas hymns and songs, traditional foods, and photos of Christmas celebrations are all available.

Leisure, Music, Entertainment, and Popular Culture

- ***La Guia-Tiempo Libre, Espectaculos y Cultura:***
<http://guia.tercera.cl/index_vi.asp>
This is a web guide to leisure activities, entertainment, and popular culture from Chile.
- ***Planeta de letras:***
<<http://www.planetadeletras.com>>
This website features the music of different artists and the lyrics to their songs.

➤ ***Teaching Spanish through Music: CASALT:***

<<http://www.caslt.org/research/musicsp.htm>>

This site provides ideas and resources for teaching Spanish through music, including a variety of links to Spanish music and lyrics.

Pen Pals and Resources for Communicating Electronically

➤ ***EPALS: Forma Parte de Epals:***

<<http://www.epals.com/register/?terms=&sessf=293882>>

The Spanish part of this website allows teachers and students to register and participate in an electronic “pen pal” (e-pals) program. The site also offers a variety of suggestions for pair activities and projects via the Internet using e-pals.

➤ ***Hot Internet Sites ¡en Español:***

<<http://www.kn.pacbell.com/wired/fil/pages/lists spanish.html-cat3>>

This site is dedicated to promoting the use of the Internet for learning Spanish. Useful links for resources are organized by grade level categories.

➤ ***Postales.com Home Page:***

<<http://www.postales.com>>

Students and teachers can email greeting cards and postcards for special occasions.

➤ ***Tarjetas Virtuales.com:***

<<http://www.tarjetasvirtuales.com/>>

This site provides virtual greeting cards for various occasions in Spanish.

➤ ***Yahoo! Postales:***

<<http://mx.greetings.yahoo.com/>>

This site allows users to personalize their own greeting cards in Spanish.

People—Family

Genealogy—Various websites related to genealogy of the Spanish-speaking world are listed below. Through these sites students may search for family names common in various Spanish-speaking countries and around the world.

➤ ***Annillo de Genealogía Hispana:***

<<http://www.elanillo.com/>>

This website features information and a variety of links related to genealogy in the Spanish-speaking world. Students can access information on Spanish heraldry and many other themes.

- ***Genealogía española e hispana:***
<<http://www.ldelpino.com/geneal.html>>
This general site provides links to a variety of genealogy-orientated websites. Links to genealogy websites for specific countries are featured.
- ***Casa de S. M. el Rey:***
<<http://www.casareal.es/casareal/home.html>>
This is the website of the Spanish royal family. The family history, biographies, and photos of significant events are all available from this site.
- ***La Familia Real: An Internet Reading Lesson:***
<<http://www.clt.net/lessons/spanish/level2/familia.html>>
This site provides an Internet-based reading unit on the Spanish royal family. Pre-reading, during reading, and post-reading activities are offered.

Places—Travel

- ***Consejos que nunca están demás al momento de conducir un vehículo:***
<<http://orbita.starmedia.com/~chevycavalier/archivos/conduccion.htm>>
This site offers advice for driving and maintaining a vehicle, including advice such as how to drive at night or in sand and what should be kept in a car for safety purposes.
- ***DB Inmuebles—Compra y venta de casas y apartamentos en España:***
<<http://www.dbinmuebles.es/intranet/prop/propsweb.nsf/Form-SearchTotal?OpenForm>>
This website features a searchable real estate database. Through this website, students can search for apartments, lots, houses, and country homes to obtain prices and descriptions.
- ***FAQ—Los transportes:***
<<http://www.tierra-inca.com/faq/es/transportes.html>>
This site includes frequently asked questions and answers about travel in Peru, and links about tourism, culture (food, music, arts and crafts, festivities), maps, and general information about Peru.
- ***MundoDomicano.com: Galería:***
<<http://www.mundodominicano.com/cgi-bin/galeria/galeria.cgi>>
The Gallery portion of the MundoDomicano site features photos of tourist sites and landscapes of Spain, Chile, Dominican Republic, and Puerto Rico. Other pages offer great information on the Dominican Republic from its history to its foods.

➤ ***Tránsito de carretera en la República Dominicana:***

<http://www.calypsodiving.de/verkehr_es.html>

This site describes types and means of transportation, and information on how to drive a rented car in the Dominican Republic.

Spanish Language, Grammar, and Vocabulary

➤ ***BBC Languages, Spanish Homepage:***

<<http://www.bbc.co.uk/languages/spanish/>>

The Spanish home page of the BBC languages website offers many resources for teachers and students. Video clips and other exercises related to the three BBC Spanish courses (Sueños, Spanish Steps, and Talk Spanish) are available. Video clips for viewing and listening to a variety of native speakers in various contexts and Hispanic countries related to all three courses are available. The site also offers news and travel information for learners of Spanish.

➤ ***BELCART: La pagina de la lengua castellana:***

<http://www.arcom.net/belca/como_esc/index.html>

This multi-faceted website features, among other things, an extensive list of common sayings.

➤ ***Centro Virtual Cervantes: Aula de lengua:***

<<http://cvc.cervantes.es/aula/>>

The Cervantes Institute website features a range of resources for teachers and students of Spanish. Resources are organized by level and theme. Short clips and animated interactive exercises make this a “must see” site.

➤ ***Gramática y ortografía:***

<<http://www.indiana.edu/~call/lengua.html>>

This award-winning site offers reference materials and other resources for using the Spanish language.

➤ ***Hojas e ideas para la clase de español:***

<<http://members.aol.com/profesoradebby/actividades.html>>

This website publishes ready-to-use classroom activities for ESL and Spanish teachers. Teachers can save these worksheets on computer as text files and use them with their classes. The site features learning activities related to the video series La Catarina, cloze exercises based on songs, and other resources.

- **Languages of Latin America—LANIC:**
<<http://www.lanic.utexas.edu/la/region/languages/>>
This website is dedicated to the diversity of languages in Latin America. Information and links are provided for various Latin American Spanish dialects, other Latin American languages, Creoles, and indigenous languages.
- **Learn Spanish:**
<<http://www.studyspanish.com/>>
This site offers many free activities and exercises for learning Spanish. Resources include vocabulary lists, grammar notes, and practice exercises.
- **Página de la lengua español:**
< <http://www.dat.etsit.upm.es/~mmonjas/espannol-largo.html>>
This general website offers resources and links to information on the Spanish language, including links to dictionaries, institutions, publications, courses, literature, and other categories.
- **Quia—Spanish activities created by its subscribers:**
<http://www.quia.com/dir/spanish/index_by_title.html>
This is a teachers' and students' site with many Spanish language learning activities. There are learning activities for many themes and for various levels. Included are activities (such as flashcards, hangman, concentration, fill-in-the-blanks, match the columns, jeopardy-like games, and other forms) for different textbooks such as *¡Dime!*, *¡Buen Viaje!*, *Ven*, and many more.
- **Spanish Language Exercises:**
<<http://mld.ursinus.edu/~jarana/Ejercicios/>>
This site, hosted by Ursinus College, features a variety of Spanish language exercises. Exercises offered provide opportunity to practice Spanish and develop greater knowledge of verbs, vocabulary, art, and writers. Teachers can choose between self-corrected exercises and instructor-checked exercises.
- **Tecla—Texts for Learners and Teachers of Spanish:**
<<http://www.sgci.mec.es/uk/Pub/tecla.html>>
Tecla is a text magazine written for learners and teachers of Spanish produced weekly during the UK academic year by the Consejería de Educación. The site features access to texts, exercises, and answer keys for a range of learners and proficiency levels. Exercises can be searched by theme or year.

- ***Universidad de Oviedo: Diccionario de Español:***
<<http://tradu.scig.uniovi.es/conjuga.html>>
This University of Oviedo website offers various resources including an online dictionary, a conjugator, and a text translator.
- ***Webspañol: Spanish Language Resources for Beginners:***
<<http://www.geocities.com/Athens/Thebes/6177/>>
Many activities and interactive exercises for beginning students of Spanish are organized by categories on this site.
- ***World Reference Dictionaries:***
<<http://www.wordreference.com/>>
This site provides online and downloadable dictionaries, which can be selected in Spanish-English, English-Spanish, French-Spanish, and many other language combinations.

Idioms

- ***Spanish-English Idioms:***
<<http://pigeon.tzo.com/spanish/index.html>>
This site provides English translations and definitions of Spanish idioms, organized alphabetically.
- ***Spanish Idioms:***
<<http://www.ctspanish.com/idioms/idioms.htm>>
This site gives examples of idioms based on different words.
- ***Spanish Slang, Expressions and Idioms:***
<<http://pigeon.tzo.com/spanish/index.html>>
This site offers tables of variations in language and idioms related to a number of different categories. Caution: This is best used as a teacher reference as some slang terms may be considered offensive.

Spanish-Speaking World

- ***El Taller:***
<<http://www.cortland.edu/flteach/usafa/taller.html>>
This website is organized around several thematic modules that complement the areas of experience of the Spanish Language and Culture curriculum.
- ***España—Una primera impresión:***
<<http://www.red2000.com/spain/primer/1hist.html>>
This site offers a brief overview of Spain—its history, people, geography, architecture, and culture. The site features many images and photos of historical and important urban and rural landscapes and buildings.

➤ **Medio Ambiente:**

<<http://usuarios.lycos.es/medam20/>>

This Spanish website provides excellent resources for intermediate and advanced students to explore issues related to various aspects of the environment, conservation, and biodiversity.

➤ **Spanish Speaking Countries: Información general por países:**

<http://www.tamu-commerce.edu/coas/litlang/flmlc/Spanish/spanish_speaking_countries.htm>

This website of the University of Texas A & M Commerce Faculty provides a range of resources in Spanish on each Spanish-speaking country, covering its history, geography, and culture.

Spanish Newspapers and Media

➤ **Periódicos hispanos:**

<<http://lsantos2000.tripod.com/resources/periodicoslatinos.htm>>

This site provides links to Hispanic newspapers throughout the world.

➤ **Prensa Escrita: Todos los periódicos diarios:**

<<http://www.prensaescrita.com>>

This site provides links to Hispanic newspapers throughout the world.

➤ **Yahoo Noticias Mexico:**

<<http://mx.news.yahoo.com/>>

This Mexican web journal site features news stories and general interest articles with links to full-coverage stories.

Latin American Periodicals by Nation—Periódicos por nación:

Argentina: <<http://www.lanacion.com.ar/>> (*La Nacion Line*)

Chile: <<http://www.emol.com/>> (*El Mercurio Online*)

Colombia: <<http://eltiempo.terra.com.co/>> (*El Tiempo*)

Costa Rica: <<http://www.nacion.co.cr/>> (*La Nación*)

Ecuador: <<http://www.elcomercio.com/>> (*El Comercio*)

El Salvador: <<http://www.elsalvador.com/>> (*El Diario de Hoy*)

España: <<http://www.elpais.es/>> (*El Pais*)

Guatemala: <<http://www.sigloxxi.com/>> (*Siglo Veituno*)

Honduras: <<http://www.laprensahn.com/>> (*Diario La Prensa*)

Nicaragua: <<http://www.laprensa.com.ni/>> (*La Prensa*)

Panamá: <<http://www.prensa.com/hoy/portada.shtml>> (*La Prensa Web*)

Paraguay: <<http://www.ultimahora.com/>> (*Diario Ultima Hora*)

Perú: <<http://www.elcomercioperu.com.pe/>> (*El Comercio*)

Puerto Rico: <<http://www.endi.com/>> (*El Nuevo Día*)

República Dominicana: <<http://www.listin.com.do/>> (*Listín Diario*)

Uruguay:

<<http://www.diariolarepublica.com/2001/larepublica.htm>> (*Diario La Republica*)

Venezuela: <<http://www.eud.com/>> (*El Universal*)

➤ **Terra:**

<<http://www.terra.es/>>

This home page of a Spanish Internet services provider features news, information, and general interest sections, links to other resources, and a Spanish search engine. Students will find information on the following areas of experience: People, Places, Leisure Activities, Foods, Shopping and Fashion, Health and Safety, and Arts and Literature.

➤ **Yahoo en España:**

<<http://es.yahoo.com/>>

This home page of the Spanish version of Yahoo! Internet services provider features news, information, and general interest sections, links to other resources, and a Spanish search engine. Students will find information on the following areas of experience: People, Places, Leisure Activities, Foods, Shopping and Fashion, Health and Safety, and Arts and Literature.

Radio Stations

➤ **Es mas radio:**

<<http://www.esmas.com/radio/>>

This site provides links to Mexican radio stations featuring music, news, and special events.

➤ **Radio Nacional España:**

<<http://www.rne.es/>>

This site provides links to National Spanish radio stations featuring music, news, and special events.

Teacher Resources

Clip art

➤ **123 Clip Art:**

<<http://123clipart.com>>

This website offers information on designing “web art” and provides many free samples organized around various themes. This is a great site for designing web pages.

➤ **Microsoft Office Clip Art and Media:**

<<http://dgl.microsoft.com/?CAG=1>>

This site provides free downloadable clip art for Microsoft Word users.

Learning Resources—Bibliographies

➤ **Manitoba Education, Citizenship and Youth-Spanish Learning Resources: Grade 7 to Senior 4 and Senior 1 to Senior 4 Compilation of Annotated Bibliographies (2000-2003):**

<<http://www.edu.gov.mb.ca/ks4/learnres/bibliographies.html>>

An annotated list of learning resources reviewed and approved for use in Manitoba schools is available from this web site.

➤ **Bibliography of Spanish Learning Resources:**

<<http://www.edu.gov.mb.ca/ks4/iru/publications/bibliographies/span1.html#teacher>>

An annotated list of Spanish resources available from the Manitoba Education, Citizenship and Youth library is provided.

Learning Resources—Supplementary Resources

➤ **Poster Pals:**

<<http://www.posterpals.ca>>

Poster Pals is a company that produces a variety of Spanish language teaching materials including posters, stickers, flashcards, and verb wheels.

➤ **Scholastic Publishers—Classroom Magazines:**

<http://teacher.scholastic.com/products/classmags/mgm_spanish.htm>

Scholastic publishes a number of classroom magazines in Spanish (e. g., ¿*Que Tal?*) and other international languages. Teachers may order sample copies and obtain information on the resources available.

➤ **Teacher's Discovery:**

<<http://www.teachersdiscovery.com/>>

Teacher's Discovery is a publisher and distributor of learning resources, which offers an extensive collection of teacher and student learning resources. The site features a searchable database, as well as information on "foreign" language conferences.

Graphic Organizers (Organizadores gráficos)

➤ **Ayudas gráficas:**

<<http://www.eduplace.com/graphicorganizer/spanish/index.html>>

Various graphic organizers on a variety of themes and topics may be downloaded in PDF file format.

➤ ***Conceptual Graphic Organizers—ED Tech:***

<<http://edservices.aea7.k12.ia.us/edtech/classroom/workshops/gofiles/gocontent.html>>

This general website is dedicated to educational technology and the use of graphic organizers. Numerous examples for a variety of content areas are available that could be adapted for Spanish.

➤ ***Graphic Organizer Makers:***

<http://teachers.teach-nology.com/web_tools/graphic_org/>

This site provides different types of makers or generators for the creation of tailored graphic organizers.

➤ ***Organizadores de conceptos:***

<<http://www3.mb.sympatico.ca/~agranson/resources/concept/index.html>>

A variety of concept maps are offered for various themes for use in Spanish classrooms.

Policy

➤ ***James Crawford's Language Policy Web Site & Emporium:***

<<http://ourworld.compuserve.com/homepages/jwcrawford>>

This U.S. American website is dedicated to the exploration of public policy and discussion respecting bilingual and foreign/international language education.

Puzzles and Games

➤ ***Discovery School's Puzzlemaker:***

<<http://www.puzzlemaker.com/>>

This website lets you create your own word puzzles, mazes, crosswords puzzles, word searches, etc.

Notes

APPENDIX D: AREAS OF EXPERIENCE

Personal	Public	Educational
<p>FAMILY (EXTENDED)</p> <ul style="list-style-type: none"> • roles and responsibilities • special events and celebrations <p>HOME</p> <ul style="list-style-type: none"> • rooms and furnishings <p>SELF</p> <ul style="list-style-type: none"> • physical <ul style="list-style-type: none"> — body — clothing • emotional <p>FRIENDS</p> <ul style="list-style-type: none"> • relationships • shared activities <p>DAILY ACTIVITIES</p> <ul style="list-style-type: none"> • routines and chores • meals • family traditions <p>LEISURE ACTIVITIES</p> <ul style="list-style-type: none"> • sports • hobbies • music 	<p>COMMERCIAL TRANSACTIONS AND BUSINESS</p> <ul style="list-style-type: none"> • shopping • restaurants • services <p>TRAVEL</p> <ul style="list-style-type: none"> • daily • vacations <p>OCCUPATIONS</p> <ul style="list-style-type: none"> • trades • professions • careers <p>MASS MEDIA</p> <ul style="list-style-type: none"> • television • newspapers and magazines • world wide web <p>ARTS AND ENTERTAINMENT</p> <ul style="list-style-type: none"> • professional sports • theatre, dance, films • music performances • visual arts and design <p>INSTITUTIONS</p> <ul style="list-style-type: none"> • government, churches, schools • public celebrations • business and industry <p>CIVIC RESPONSIBILITIES</p> <ul style="list-style-type: none"> • conservation • charitable activities 	<p>HUMANITIES</p> <ul style="list-style-type: none"> • literature • arts <p>SOCIAL SCIENCES</p> <ul style="list-style-type: none"> • geography • history • social issues <p>NATURAL SCIENCES AND MATHEMATICS</p> <ul style="list-style-type: none"> • weather and climate • animals and plants • technology • inventions • money • ecology and the environment • outer space <p>HEALTH AND PHYSICAL EDUCATION</p> <ul style="list-style-type: none"> • physical activity • nutrition • public health issues

Notes

APPENDIX E: GLOBAL LIST OF STRATEGIES

Language Learning Strategies

Cognitive

- listen attentively
- do actions to match words of a song, story, or rhyme
- learn short rhymes or songs incorporating new vocabulary or sentence patterns
- imitate sounds and intonation patterns
- memorize new words by repeating them silently or aloud
- seek the precise term to express their meaning
- repeat words or phrases in the course of performing a language task
- make personal dictionaries
- experiment with various elements of the language
- use mental images to remember new information
- group together sets of things (e.g., vocabulary, structures) with similar characteristics
- identify similarities and differences between aspects of the language being learned and their own language
- look for patterns and relationships
- use previously acquired knowledge to facilitate a learning task
- associate new words or expressions with familiar ones, either in the language being learned or in their own language
- find information using reference materials like dictionaries, textbooks, and grammars
- use available technological aids to support language learning (e.g., cassette recorders, computers)
- use word maps, mind maps, diagrams, charts, or other graphic representations to make information easier to understand and remember
- place new words or expressions in a context to make them easier to remember
- use induction to generate rules governing language use
- seek opportunities outside of class to practise and observe
- perceive and note down unknown words and expressions, noting also their context and function

Metacognitive

- check copied writing for accuracy
- make choices about how they learn
- rehearse or role play language
- decide in advance to attend to the learning task
- reflect on learning tasks with the guidance of the teacher
- make a plan in advance about how to approach a language learning task
- reflect on the listening, reading, and writing processes
- decide in advance to attend to specific aspects of input
- listen or read for key words
- evaluate their own performance or comprehension at the end of a task
- keep a learning log
- experience various methods of language acquisition, and identify one or more that they consider particularly useful personally
- be aware of the potential of learning through direct exposure to the language
- know how strategies may enable them to cope with texts containing unknown elements
- identify problems that might hinder successful completion of a task and seek solutions
- monitor their own speech and writing to check for persistent errors
- be aware of their own strengths and weaknesses, identify their own needs and goals, and organize their strategies and procedures accordingly

Social/Affective

- initiate or maintain interaction with others
- participate in shared reading experiences
- seek the assistance of a friend to interpret a text
- reread familiar self-chosen texts to enhance understanding and enjoyment
- work cooperatively with peers in small groups
- understand that making mistakes is a natural part of language learning
- experiment with various forms of expression, and note their acceptance or non-acceptance by more experienced speakers

- participate actively in conferencing and brainstorming as a pre- and post-writing exercise
- use self-talk to make themselves feel competent to do the task
- be willing to take risks, to try unfamiliar tasks and approaches
- repeat back new words and expressions occurring in conversations in which they participate, and make use of the new words as soon as appropriate
- reduce anxiety by using mental techniques, such as positive self-talk or humour
- work with others to solve problems, and get feedback on tasks
- provide personal motivation by arranging rewards for themselves when successful

Language Use Strategies

Interactive

- use words from their first language to get their meaning across (e.g., use a literal translation of a phrase in the first language, use a first language word but pronounce it as in the second language)
- acknowledge being spoken to
- interpret and use a variety of non-verbal clues to communicate (e.g., mime, pointing, gestures, drawing pictures)
- indicate lack of understanding verbally or non-verbally (e.g., Pardon, Sorry, I didn't understand, raised eyebrows, blank look)
- ask for clarification or repetition when they do not understand (e.g., What do you mean by...?, Could you say that again, please?)
- use the other speakers' words in subsequent conversation
- assess feedback from conversation partner to recognize when the message has not been understood (e.g., raised eyebrows, blank look)
- start again using a different tactic when communication breaks down (e.g., What I'm trying to say is...)
- invite others into the discussion
- ask for confirmation that a form used is correct (e.g., Can you say that?)
- use a range of fillers, hesitation devices, and gambits to sustain conversations (e.g., Well, actually..., Where was I?...)
- use circumlocution to compensate for lack of vocabulary (e.g., the thing you hang clothes on for hanger)
- repeat back part of what someone has said to confirm mutual understanding (e.g., So what you are saying is...)
- summarize the point reached in a discussion to help focus the talk

- ask follow-up questions to check for understanding (e.g., Am I making sense?)
- use suitable phrases to intervene in a discussion (e.g., Speaking of...)
- self-correct if errors lead to misunderstandings (e.g., What I mean to say is...)

Interpretive

- use gestures, intonation, and visual supports to aid comprehension
- make connections between texts on the one hand, and prior knowledge and personal experience on the other
- use illustrations to aid reading comprehension
- determine the purpose of listening
- listen or look for key words
- listen selectively based on purpose
- make predictions about what they expect to hear or read based on prior knowledge and personal experience
- use knowledge of the sound-symbol system to aid reading comprehension
- infer probable meaning of unknown words or expressions from contextual clues
- prepare questions or a guide to note down information found in the text
- use key content words or discourse markers to follow an extended text
- reread several times to understand complex ideas
- summarize information gathered
- assess their own information needs before listening, viewing, or reading
- use skimming and scanning to locate key information in texts

Productive

- mimic what the teacher says
- use non-verbal means to communicate
- copy what others say or write
- use words visible in the immediate environment
- use resources to increase vocabulary
- use familiar repetitive patterns from stories, songs, rhymes, or media
- use illustrations to provide detail when producing their own texts
- use various techniques to explore ideas at the planning stage, such as brainstorming or keeping a notebook or log of ideas

- use knowledge of sentence patterns to form new sentences
- be aware of and use the steps of the writing process: pre-writing (gathering ideas, planning the text, research, organizing the text), writing, revision (rereading, moving pieces of text, rewriting pieces of text), correction (grammar, spelling, punctuation), publication (reprinting, adding illustrations, binding)
- use a variety of resources to correct texts (e.g., personal and commercial dictionaries, checklists, grammars)
- take notes when reading or listening to assist in producing their own text
- revise and correct final version of text
- use circumlocution and definition to compensate for gaps in vocabulary
- apply grammar rules to improve accuracy at the correction stage
- compensate for avoiding difficult structures by rephrasing

General Learning Strategies

Cognitive

- classify objects and ideas according to their attributes (e.g., red objects and blue objects or animals that eat meat and animals that eat plants)
- use models
- connect what they already know with what they are learning
- experiment with and concentrate on one thing at a time
- focus on and complete learning tasks
- write down key words and concepts in abbreviated form (verbal, graphic, or numerical) to assist performance of a learning task
- use mental images to remember new information
- distinguish between fact and opinion when using a variety of sources of information
- formulate key questions to guide research
- make inferences; identify and justify the evidence on which their inferences are based
- use word maps, mind maps, diagrams, charts, or other graphic representations to make information easier to understand and remember
- seek information through a network of sources including libraries, the world wide web, individuals, and agencies
- use previously acquired knowledge or skills to assist with a new learning task

Metacognitive

- reflect on learning tasks with the guidance of the teacher
- choose from among learning options
- discover how their efforts can affect their learning
- reflect upon their thinking processes and how they learn
- decide in advance to attend to the learning task
- divide an overall learning task into a number of sub-tasks
- make a plan in advance about how to approach a task
- identify their own needs and interests
- manage the physical environment in which they have to work
- keep a learning journal such as a diary or a log
- develop criteria for evaluating their own work
- work with others to monitor their own learning
- take responsibility for planning, monitoring, and evaluating learning experiences

Social/Affective

- watch others' actions and copy them
- seek help from others
- follow their natural curiosity and intrinsic motivation to learn
- participate in cooperative group learning tasks
- choose learning activities that enhance understanding and enjoyment
- encourage themselves to try, even though they might make mistakes
- take part in group decision-making processes
- use support strategies to help peers persevere at learning tasks (e.g., offer encouragement, praise, ideas)
- take part in group problem-solving processes
- use self-talk to make themselves feel competent to do the task
- be willing to take risks, to try unfamiliar tasks and approaches
- monitor their level of anxiety about learning tasks and take measures to lower it if necessary (e.g., deep breathing, laughter)
- use social interaction skills to enhance group learning activities

REFERENCES

REFERENCES

- Alberta Assessment Consortium. *A Framework for Student Assessment*. Edmonton, AB: Alberta Assessment Consortium, 1997.
- Alberta Education. *Framework for a Locally Developed Language Arts Curriculum (ECS–Grade 12) for a Language Other Than English or French*. Edmonton, AB: Alberta Education Language Services Branch, 1991.
- . *Framework for a Proficiency-Based Second Language Curriculum*. Edmonton, AB: Alberta Education Language Services Branch, 1988.
- . *Locally Developed Language and Culture Programs: Guidelines for Development*. Edmonton, AB: Alberta Education Curriculum Standards Branch, 1994.
- . *English 10: Teacher Manual: Classroom Assessment Materials*. Edmonton, AB: Alberta Education, 1997.
- Alberta Learning. *Spanish Language and Culture Program of Studies (Grade 7-9)*. Edmonton, AB: Alberta Learning Curriculum Standards Branch, 2000.
- Alfaro, María Sánchez, and Alfredo González Hermoso. *Colección Tiempo: Para comprender: Mensajes orales de la vida cotidiana (To Understand: Oral Messages about Daily Life)*. Madrid, ES: Edelsa Grupo Didascalía, SA, 2002.
- Alsop, T.W. *¡En grupos!: A Cooperative Learning Workbook for Beginning Students (In Groups!...)*. Lincolnwood, IL: NTC Publishing Group, 1998.
- Anderson, Charlotte, with Susan K. Nicklas, and Agnes R. Crawford. *Global Understandings: A Framework for Teaching and Learning*. Alexandria, VA: ASCD, 1994.
- Association for Supervision and Curriculum Development. *ASCD Curriculum Handbook: A Resource for Curriculum Administrators from the Association for Supervision and Curriculum Development*. Alexandria, VA: The Curriculum Technology Resource Center, Association for Supervision and Curriculum Development, 1991.
- . *Challenging the Gifted in the Regular Classroom: Facilitator's Guide*. Alexandria, VA: ASCD, 1994.
- Baker, Colin. *Foundations of Bilingual Education and Bilingualism*. 3rd ed. Bilingual Education and Bilingualism. 27. Clevedon, UK: Multilingual Matters, 2001.

- . *A Parents' and Teachers' Guide to Bilingualism*. Bilingual Education and Bilingualism. 5. Clevedon, UK: Multilingual Matters, 1995.
- Bamford, K. W., and D. T. Mizokawa. "Additive-Bilingual (Immersion) Education: Cognitive and Language Development." *Language Learning* 41.3 (1991): 413–429.
- Barik, Henri, and Merrill Swain. "Three Year Evaluation of a Large-Scale Early Grade French Immersion Program: The Ottawa-Study." *Language Learning* 25.1 (1975): 1–30.
- Belisle-Chatterjee, Ava, Linda West Tibensky, and Abraham Martínez-Cruz. *¡Viva el Español!: ¡Hola! Annotated Teacher's Edition*. Whitby, ON: McGraw-Hill Ryerson Limited, 1997.
- . *¡Viva el Español!: ¡Hola! Resource & Activity Book Blackline Masters*. Whitby, ON: McGraw-Hill Ryerson Limited, 1997.
- . *¡Viva el Español!: ¡Adelante! (Hooray Spanish! Forward!) Resource & Activity Book Blackline Masters*. Whitby, ON: McGraw-Hill Ryerson Limited, 1997.
- . *¡Viva el Español!: ¿Qué Tal? Resource & Activity Book Blackline Masters*. Whitby, ON: McGraw-Hill Ryerson Limited, 1997.
- . *¡Viva el Español!: ¡Hola! Culture Resource Book Blackline Masters*. Whitby, ON: McGraw-Hill Ryerson Limited, 1997.
- . *¡Viva el Español!: ¿Qué Tal? Culture Resource Book Blackline Masters*. Whitby, ON: McGraw-Hill Ryerson Limited, 1997.
- Bellanca, James. *The Cooperative Think Tank II: Graphic Organizers to Teach Thinking in the Cooperative Classroom*. Arlington Heights, IL: IRA Skylight, 1992.
- Bialystok, E. *Bilingualism in Development: Language, Literacy, and Cognition*. New York, NY: Cambridge University Press, 2001.
- . *Communication Strategies: A Psychological Analysis of Second Language Use*. Oxford, UK: Basil Blackwell, 1990.
- . "Effects of Bilingualism and Biliteracy on Children's Emergent Concepts of Print." *Developmental Psychology* 30.3 (1997): 429–440.
- . *Language Processing in Bilingual Children*. London, UK: Cambridge University Press, 1991.
- Bialystok, E., and K. Hakuta. *In Other Words*. New York, NY: Basic Books, 1994.
- Bloom, B.S. *Stability and Change in Human Characteristics*. New York, NY: Wiley, 1964.

- Brewer, C., and D. Campbell. *Rhythms of Learning*. Tucson, AZ: Zephyr, 1998.
- Brickman, W. W. "The Multilingual Development of the Gifted." *Roeper Review* 10.4 (1998): 247–250.
- Bruck, M., W.E. Lambert, and R. Tucker. "Bilingual Schooling Through the Elementary Grades: The St. Lambert Project at Grade Seven." *Language Learning* 24.2 (1974): 183–204.
- Byram, M., and Geneviève Zarate. *Young People Facing Difference: Some Proposals for Teachers*. Strasbourg, France: Council of Europe Publishing, 1995.
- Campbell, D. *The Mozart Effect*. New York, NY: Avon, 1997.
- Canale, M., and M. Swain. "Theoretical Bases of Communicative Approaches to Second Language Teaching and Testing." *Applied Linguistics* 1 (1980): 1–47.
- Carrera-Hanley, Terese. *Ventanas tres*. Evanston, IL: McDougal-Littell Inc., 1998.
- Cassagne, J.M. *101 Spanish Idioms*. Lincolnwood, IL: Passport Books, NTC Publishing Co., 1995.
- Celce-Murcia, Marianne, Zoltán Dörnyei, and Sarah Thurrell. "Communicative Competence: A Pedagogically Motivated Model with Content Specifications." *Issues in Applied Linguistics* 6.2 (1995): 5–35.
- Cerrolaza, Matilde, Óscar Cerrolaza, and Begoña Llovet. *Planet@ 1: Libro del Profesor (Teacher's Guide)*. Madrid, ES: Edelsa Grupo Didascalía, SA, 1998.
- . *Planet@ 2: Libro del Profesor (Teacher's Guide)*. Madrid, ES: Edelsa Grupo Didascalía, SA, 1998.
- . *Planet@ 3: Libro del Profesor (Teacher's Guide)*. Madrid, ES: Edelsa Grupo Didascalía, SA, 2000.
- . *Planet@ 4: Libro Del Alumno: Curso de perfeccionamiento (Student Book: A Course for Mastering (Spanish))*. Madrid, ES: Edelsa Grupo Didascalía, SA, 2000.
- C.H.A.D.D. *Meeting the Special Needs of Students*. Mission Hills, CA: Glencoe/McGraw-Hill, 1997.
- Cooper, T. C. "Foreign Language Study and SAT-Verbal Scores." *Modern Language Journal* 71.4 (1987): 381–387.
- Cordeiro, Tess. *VERBingo and More*. Etobicoke, ON: Language In Play International, 2000.

- Council of Europe. *Common European Framework of Reference for Languages: Learning, Teaching, Assessment*. London, UK: Cambridge University Press, February 2001.
- Curtain, H. *Early Start Language Programs*. Unpublished paper. Madison, WI: Author, 1997.
- Curtain, H. and C. A. Pesola. *Languages and Children: Making the Match*. 2nd ed. White Plains, NY: Longman, 1994.
- Curtiss, S., speaker. *Gray Matters: The Developing Brain*. Final script of radio broadcast. Madison, WI: Wisconsin Public Radio Association, 1995.
- Destinos: An Introduction to Spanish*. Video series. Boston, MA: WGBH, 1992.
- Diamond, M. *Enriching Heredity*. New York, NY: Macmillan, 1988.
- Doman, G. *Teach Your Baby to Read*. Philadelphia, PA: The Better Baby Press, 1984.
- Dryden, Gordon, and Jeannette Vos. *The Learning Revolution*. Auckland, NZ: The Learning Web, 1997.
- Dryden, Gordon, and Colin Rose. *Fundamentals*. Aylesbury, UK: Accelerated Learning Systems, 1995.
- Dueñas, Carlos Romero, and Alfredo González Hermoso. *Colección Tiempo: Para pronunciar: + de 100 ejercicios para practicar y mejorar la pronunciación del español (Exercises for Spanish Pronunciation)*. Madrid, ES: Edelsa Grupo Didascalía, SA, 2002.
- Eddy, P. A. *The Effect of Foreign Language Study in High School on Verbal Ability as Measured by the Scholastic Aptitude Test—Verbal Final Report*. Washington, DC: Center for Applied Linguistics, 1981. ERIC Document Reproduction Service No. ED 196 312.
- Edmonton Public Schools. *Planning for Success: Templates for Using the Elementary Curriculum Grades 1–6*. Edmonton, AB: Resource Development Services, 1998.
- Encinar, Ángeles. *USO interactivo del vocabulario (Interactive Vocabulary)*. Madrid, ES: Edelsa Grupo Didascalía, SA, 2000.
- España Viva*. Video course. Dir. Stephen Moss. Films Incorporated Video, 1989/1992.
- Farrell, Edith R., and C. Frederick Farrell, Jr., eds. *Side by Side, Spanish & English Grammar*. Lincolnwood, IL: Passport Books, NTC Publishing Group, 1995.

- Fogarty, Robin. *Brain-Compatible Classrooms*. Arlington Heights, IL: SkyLight Training and Publishing, 1997.
- Gahalla, E. et al. *¡En español! 2 (In Spanish 2)*. (En español 2 series). Evanston, IL: McDougal, Littell/Houghton Mifflin, 2000.
- . *¡En español! 3 (In Spanish 3)*. (En Español 3 series). Evanston, IL: McDougal, Littell/Houghton Mifflin, 2000.
- . *¡En español! 1: ¡En español! Level 1 (Student Book)* (En español 1 series). Evanston, IL: McDougal, Littell/Houghton Mifflin, 2000.
- Gardner, Howard. *Frames of Mind*. New York, NY: Basic Books, 1983.
- . Speech. American Education Research Conference. San Diego, CA. April 1998.
- Genesee, F. "Is There an Optimal Age for Starting Second Language Instruction?" *McGill Journal of Education* 13.2 (1978): 145–154.
- . *Learning Through Two Languages*. Cambridge, MA: Newbury House, 1987.
- . "The Role of Intelligence in Second Language Learning." *Language Learning* 26.2 (1976): 267–280.
- Governments of Alberta, British Columbia, Manitoba, Saskatchewan, Northwest Territories, and Yukon Territory. *The Common Curriculum Framework for English Language Arts, Kindergarten to Grade 12 (Grades 10–12 Draft): Western Canadian Protocol for Collaboration in Basic Education*. Winnipeg, MB: Manitoba Education and Training, 1996.
- Governments of Alberta, Manitoba, and Saskatchewan. *The Common Curriculum Framework for Bilingual Programming in International Languages: Kindergarten to Grade 12: Western Canadian Protocol for Collaboration in Basic Education*. Edmonton, AB: Alberta Learning, 1999.
- Governments of Manitoba, Saskatchewan, and Alberta. *The Common Curriculum Framework for International Languages: Kindergarten to Grade 12: Western Canadian Protocol for Collaboration in Basic Education*. Regina, SK: Saskatchewan Education, 2000.
- Hakuta, K. *Cognitive Development of Bilingual Children*. Los Angeles, CA: University of California, Center for Language Education and Research, 1986. ERIC Document Reproduction Service No. ED 278 260.
- Harley, B. *Age in Second Language Acquisition*. San Diego, CA: College Hill Press, 1986.

- Houston, J. *Educating the Possible Human*. Quoted in *The Learning Revolution*. Auckland, NZ: Learning Web, 1997.
- Hymes, D. "Models of the Interaction of Language and Social Life." *Directions in Sociolinguistics*. Ed. J.J. Gumperz, and D. Hymes. New York, NY: Holt, Rinehart and Winston, 1972. 35–71.
- Jensen, E. *The Learning Brain*. San Diego, CA: Turning Point for Teachers, 1994.
- Johnson, J. S., and E. L. Newport. "Critical Period Effects in Second Language Learning: The Influence of Maturational State on the Acquisition of English as a Second Language." *Cognitive Psychology* 21.1 (1989): 60–99.
- Kotulak, Ronald. *Inside the Brain: Revolutionary Discoveries of How the Mind Works*. Kansas City, KS: Andrews McMeel Publishing, 1996.
- Krashen, Stephen. *Fundamentals of Language Education*. Beverly Hills, CA: Laredo, 1992.
- . *Principles and Practice in Second Language Acquisition*. Oxford, UK: Pergamon Press, 1982.
- La Cultura en Juego: Un viaje lúdico hacia el España través de la cultura hispánica (Culture in Play)*. Madrid, ES: Edelsa Grupo Didascalía, SA, 2001.
- Lapkin, S., and M. Swain. *French Immersion Research Agenda for the 90's*. Toronto, ON: Modern Language Centre, O.I.S.E, 1989.
- Larsen-Freeman, D. *Techniques and Principles in Language Teaching*. Oxford, UK: Oxford University Press, 2000.
- LeBlanc, Raymond. *National Core French Study: A Synthesis*. Ottawa, ON: M. Editeur and Canadian Association of Second Language Teachers, 1990.
- Lee, James F., and B. VanPatten. *Making Communicative Language Teaching Happen*. New York, NY: McGraw, 1995.
- Lozanov, G. *Outlines of Suggestopedia*. New York, NY: Gordon & Breech, 1978.
- Lynch, Jack. "The Indo-European Language Family Tree." <<http://newark.rutgers.edu/~jlynch/language.html>>. 9 Oct. 2003.
- MacLean, P.D. *The Triune Brain in Evolution*. New York, NY: Plenum, 1990.
- Manitoba Education and Training. *A Foundation for Excellence*. Winnipeg, MB: Manitoba Education and Training, June 1995.

- . *Grades 5 to 8 English Language Arts: A Foundation for Implementation*. Winnipeg, MB: Manitoba Education and Training, 1998.
 - . *Policy for Heritage Language Instruction*. Winnipeg, MB: Manitoba Education and Training, 1993.
 - . *Secondary Sourcebook for Integrating ESL and Content Instruction Using the FORESEE Approach*. Winnipeg, MB: Manitoba Education and Training, 1994.
 - . *Senior 2 Spanish: A Full Course for Distance Education Delivery (Field Validation Version)*. Winnipeg, MB: Manitoba Education and Training, 1997.
 - . *Spanish 10G: ¡Bienvenido! ¡Bienvenida!* Dirs. Doug Glover and Felipe Flores. Videocassette. Winnipeg, MB: Manitoba Education and Training, 1995.
 - . *Success for All Learners: A Handbook on Differentiating Instruction: A Resource for Kindergarten to Senior 4 Schools*. Winnipeg, MB: Manitoba Education and Training, 1996.
- Manitoba Education and Youth. *Senior 1 Spanish: A Course for Distance Learning*. Winnipeg, MB: Manitoba Education and Youth, 2002.
- Marcos, Kathleen M. "Second Language Learning: Everyone Can Benefit." *K-12 Foreign Language Education: The ERIC Review* 6.1 (Fall 1998).
 <<http://www.languagemagazine.com/internetedition/nd99/pg23.html>>
- Marsh, Valeri, and Christine Anderson. *Cuéntame más!* Chandler, AZ: CW Publishing, 1993.
- McTighe, J., and S. Ferrara. *Assessing Learning in the Classroom. A Report from Professional Standards and Practice*. Washington, DC: National Education Association, 1994.
- Met, Myriam. Ed. *Critical Issues in Early Second Language Learning*. Glenview, IL: Scott Foresman-Addison Wesley, 1998.
- . "Foreign Language." *Handbook of Research on Improving Student Achievement*. Ed. Gordon Cawelti. Arlington, VA: Educational Research Service, 1995. 43–57.
 - . "Middle Schools And Foreign Languages: A View For The Future." *ERIC Digest*, February 1996. ERIC Document Reproduction Service No. EDO-FL-96-05
 <<http://www.cal.org/ericcll/digest/met00002.html>>. 28 Nov. 2002.

- Met, Myriam, and V. Galloway. "Research in Foreign Language Curriculum." *Topics and Issues Within Curriculum Categories*. Ed. P. Jackson. New York, NY: Macmillan, 1992.
- Miguel, L., and N. Sans. *Como Sueno 1*. Madrid, ES: Difusion, 1991.
- . *Como Sueno 2*. Madrid, ES: Difusion, 1991.
- National Standards in Foreign Language Education Project. Student Standards Task Force. *Standards for Foreign Language Learning: Preparing for the 21st Century*. Yonkers, NY: National Standards in Foreign Language Education Project, 1996.
- Nebraska Department of Education. *Nebraska K-12 Foreign Language Frameworks*. 1996.
<<http://nde4.nde.state.ne.us/CURR/forlang/ForLang.html>>
- Neisser Echenberg, Eva. *Abrir Paso: Abrir Paso Libro 1*. Montreal, PQ: Miraflores, 1999.
- New Jersey State Department of Education. *New Jersey World Languages Curriculum Framework*. Trenton, NJ: New Jersey State Department of Education, 1999.
- Ornstein, R. *The Amazing Brain*. Boston, MA: Houghton Mifflin, 1984.
- Palencia, Ramón. *USO de la gramática española: Junior elemental Libro del alumno (Student Book)*. Madrid, ES: Edelsa Grupo Didascalía, SA, 2001.
- . *USO de la gramática española: Junior intermedio Libro del alumno (Student Book)*. Madrid, ES: Edelsa Grupo Didascalía, SA, 2002.
- Palomino, María Ángeles. *Chicos Chicas: nivel 1 Libro del alumno CD audio (Student Book, CD audio)*. Madrid, ES: Edelsa Grupo Didascalía, SA, 2002.
- . *Chicos Chicas: nivel 1 Libro del alumno, casetes 1 y 2 (Student Book, Audiocassettes)*. Madrid, ES: Edelsa Grupo Didascalía, SA, 2002.
- . *Colección Tiempo: Para conjugar: Prácticas sobre los 100 verbos más usuales (To Conjugate: Practicing with 100 Verbs)*. Madrid, ES: Edelsa Grupo Didascalía, SA, 2001.
- . *Chicos Chicas: nivel 1 Libro del alumno (Student Book)*. Madrid, ES: Edelsa Grupo Didascalía, SA, 2002.
- . *Primer plano 2: Libro del Profesor (Teacher's Guide)*. Madrid, ES: Edelsa Grupo Didascalía, SA, 2001.
- Paso a Paso 2 La Catrina 2 (Step by Step Catrina 2)*. Video. (Paso a Paso 2 series). Glenview, IL: Scott Foresman, 1996.

- Paulson, F. Leon, Pearl R. Paulson, and Carol Meyer. "What Makes a Portfolio a Portfolio?" *Educational Leadership* 48 (1991): 60–63.
- Pufahl, Ingrid, Nancy C. Rhodes, and Donna Christian. *What We Can Learn From Foreign Language Teaching In Other Countries*. Washington, DC: Center for Applied Linguistics, September 2001.
- Quesada, Sebastián. *Imágenes de América Latina: Manual de historia y cultura latinoamericanas (History & Latin America Manual)*. Madrid, ES: Edelsa Grupo Didascalía, SA, 2001.
- Quesada, Sebastián. *Imágenes de España (Images from Spain)*. (Imágenes de España series). Madrid, ES: Edelsa Grupo Didascalía, SA, 2001.
- ¿Qué Tal?. (*Revista*). London, UK: Scholastic Press/ Mary Glasgow Magazines, 1999.
- Reis, S. M., D. E. Burns, and J. S. Renzulli. *Curriculum Compacting: The Complete Guide to Modifying the Regular Curriculum for High Ability Students*. Mansfield Center, CT: Creative Learning Press, 1992.
- Reissman, Rose. *The Evolving Multicultural Classroom*. Alexandria, VA: ASCD, 1994.
- Richards, J., and T. Rodgers. *Approaches and Methods in Language Teaching*. 2nd ed. Cambridge, UK: Cambridge University Press, 2001.
- Rodgers, Theodore S. "Language Teaching Methodology." (ERIC Issue Paper). Washington, DC: ERIC Clearinghouse on Languages and Linguistics, 2001.
- The Rosetta Stone Spanish Level I, Classroom Edition* (Computer Software). Harrisonburg, VA: Fairfield Language Technologies, 2000.
- The Rosetta Stone Spanish Level II, Classroom Edition* (Computer Software). Harrisonburg, VA: Fairfield Language Technologies, 2000.
- The Rosetta Stone Spanish Level III, Classroom Edition* (Computer Software). Harrisonburg, VA: Fairfield Language Technologies, 2000.
- Sainz, Teresa Gonzalez. *Para jugar. Juegos comunicativos. Español lengua extranjera*. Madrid, ES: Ediciones SM, 1994.
- Samaniego, Fabian A. et al. *¡Dime! Algo: ¡Dime! Algo (Extended Teacher's Edition)*. (¡Dime! Algo series). Evanston, IL: McDougal, Littell/Houghton Mifflin Company, 1997.
- . *¡Dime! Dos: ¡Dime! Dos (Tell me! Two)*. (¡Dime! Dos series). Evanston, IL: McDougal, Littell/Houghton Mifflin Company, 1997.

- . *¡Dime! Más: ¡Dime! Más (Extended Teacher's Edition)*. (¡Dime! Más series). Evanston, IL: McDougal, Littell/Houghton Mifflin Company, 1997.
- . *¡Dime! Mas: ¡Dime! Pasaporte al Mundo 21 Level 3 (Extended Teacher's Edition)*. (¡Dime! Pasaporte al Mundo 21 series). Evanston, IL: McDougal, Littell/Houghton Mifflin Company, 1997.
- . *¡Dime! Uno: ¡Dime! Uno (Tell Me! One)*. (¡Dime! Uno series). Evanston, IL: McDougal, Littell/Houghton Mifflin Company, 1997.
- Saskatchewan Education. *Instructional Approaches: A Framework for Professional Practice*. 1991.
<<http://www.sasked.gov.sk.ca/docs/policy/approach/index.html>>.
- Saskatchewan Education, Training and Employment. *Multicultural Education and Heritage Language Education Policies*. Regina, SK: Curriculum and Instruction Branch, Social Sciences Unit, 1994.
- Savaiano, Eugene, and Lynn W. Winget. *2001 Spanish and English Idioms*. 2nd ed. Hauppauge, NY: Barron's Educational Series, 1995.
- Schmitt, Conrad J. *¡Buen Viaje! 1: ¡Buen Viaje! 1A (Student Book)*. (¡Buen Viaje! 1 series). New York, NY: Glencoe/McGraw Hill, 2000.
- . *¡Buen Viaje! 1: ¡Buen Viaje! 1A Teacher's Manual*. (¡Buen Viaje! 1 series). New York, NY: Glencoe/McGraw Hill, 2000.
- . *¡Buen Viaje! 1: ¡Buen Viaje! 1B (Student Book)*. (¡Buen Viaje! 1 series). New York, NY: Glencoe/McGraw Hill, 2000.
- . *¡Buen Viaje! 2: ¡Buen Viaje! 2 (Student Book)*. (¡Buen Viaje! 2 series). New York, NY: Glencoe/McGraw Hill, 2000.
- . *¡Buen Viaje! 2: ¡Buen Viaje! 2 Teacher's Manual*. (¡Buen Viaje! 2 series). New York, NY: Glencoe/McGraw Hill, 2000.
- . *¡Buen Viaje! 3: ¡Buen Viaje! 3 (Student Book)*. (¡Buen Viaje! 3 series). New York, NY: Glencoe/McGraw Hill, 2000.
- . *¡Buen Viaje! 3: ¡Buen Viaje! 3 Teacher's Manual*. (¡Buen Viaje! 3 series). New York, NY: Glencoe/McGraw Hill, 2000.
- . *¡Buen Viaje! 1: ¡Buen Viaje! 1B Teacher's Manual*. (¡Buen Viaje! 1 series). New York, NY: Glencoe/McGraw Hill, 2000.
- Schulz, Renate A. 1998. "Foreign Language Education in the United States: Trends and Challenges." *The ERIC Review* 6.1 (Fall 1998): Section 1, 6–13.
<<http://www.eric.ed.gov/resources/ericreview/vol6no1/splash.html>>.

- Seaman, D., and R. Fellenz. *Effective Strategies for Teaching Adults*. Columbus, OH: Merrill, 1989.
- Short, Daniel M. "Family Tree of Indo-European Languages." 2003 <<http://www.danshort.com/ie/>>. 10 Oct. 2003.
- Stokes, G., and D. Whiteside. *One Brain: Dyslexic Learning Correction and Brain Integration*. Burbank, CA: Three-In One Concepts, 1984.
- Swain, M. "Early French Immersion Later On." *Journal of Multicultural Development* 2.1 (1981): 1–23.
- Swain, M., and S. Lapkin. "Additive Bilingualism and French Immersion Education: The Roles of Language Proficiency and Literacy." *Bilingualism, Multiculturalism, and Second Language Learning: The McGill Conference in Honour of Wallace E. Lambert*. Ed. A. Reynolds. Hillsdale, NJ: Erlbaum, 1991.
- . "Canadian Immersion and Adult Second Language Teaching: What's the Connection?" *Modern Language Journal* 73.2 (1989): 150–159.
- Terrell, Tracy et al. *Dos Mundos (Student Edition)*. New York, NY: McGraw-Hill, 1998.
- Thomas, W. P., V. P. Collier, and M. Abbott. "Academic Achievement through Japanese, Spanish, or French: The First Two Years of Partial Immersion." *Modern Language Journal* 77.2 (1993): 170–180.
- Tokuhama-Espinosa, Tracey. *Raising Multilingual Children: Foreign Language Acquisition and Children*. Westport, CT: Bergin and Garvey, October 2000
- Weatherford, H.J. "Personal Benefits of Foreign Language Study." *ERIC Digest*. Washington, DC: ERIC Clearinghouse on Languages and Linguistics, 1986. ERIC Document Reproduction Service No. 276 305.
- White, B. *Raising a Delightful Unspoiled Child*. New York, NY: Simon & Shuster, 1994.

Notes



Printed in Canada
Imprimé au Canada