TEACHING AND LEARNING SPANISH LANGUAGE AND CULTURE

The Philosophy and Principles of Teaching and Learning Spanish Language and Culture	3
Teaching and Learning in the Spanish Classroom	45
Combined Grades in the Second Language Classroom	105

TEACHING AND LEARNING SPANISH LANGUAGE AND CULTURE

The Philosophy and Principles of Teaching and Learning Spanish Language and Culture

Second Language Teaching Methodologies*

Theodore Rodgers argues that methodology in second language teaching has been characterized in a variety of ways. A somewhat classical formulation suggests that methodology is that which links theory and practice. Theory statements would include theories of what language is and how language is learned or, more specifically, theories of second language acquisition (SLA). Such theories are linked to various design features of language instruction. These design features might include stated objectives, syllabus specifications, types of activities, roles of teachers and learners, materials, and so forth. Design features in turn are linked to actual teaching and learning practices as observed in the environments where language teaching and learning take place. This whole complex of elements defines language teaching methodology.

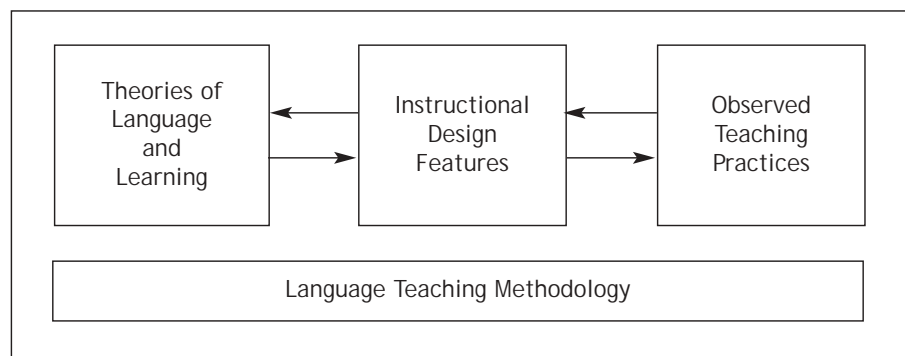

Figure 1. Language Teaching Methodology

(From: *Language Teaching Methodology* by Theodore S. Rodgers, Professor Emeritus, University of Hawaii)

Schools of Language Teaching Methodology

Within methodology a distinction is often made between methods and approaches. Methods are held to be fixed teaching systems with prescribed techniques and practices, whereas approaches represent language teaching philosophies that can be interpreted and applied

* Adapted from *Language Teaching Methodology* by Theodore S. Rodgers, Professor Emeritus, University of Hawaii.

in a variety of different ways in the classroom. This distinction is probably most usefully seen as defining a continuum of entities ranging from highly prescribed methods to loosely described approaches.

The period from the 1950s to the 1980s has often been referred to as “The Age of Methods,” during which a number of quite detailed prescriptions for language teaching were proposed. Situational Language Teaching evolved in the United Kingdom while a parallel method, Audio-Lingualism, emerged in the United States. In the middle-methods period, a variety of methods were proclaimed as successors to the then prevailing Situational Language Teaching and Audio-Lingual methods. These alternatives were promoted under such titles as Silent Way, Suggestopedia, Community Language Learning, and Total Physical Response. In the 1980s, these methods in turn came to be overshadowed by more interactive views of language teaching, which collectively came to be known as Communicative Language Teaching (CLT). Communicative Language Teaching advocates subscribed to a broad set of principles such as these:

- Learners learn a language through using it to communicate.
- Authentic and meaningful communication should be the goal of classroom activities.
- Fluency is an important dimension of communication.
- Communication involves the integration of different language skills.
- Learning is a process of creative construction and involves trial and error.

However, CLT advocates avoided prescribing the set of practices through which these principles could best be realized, thus putting CLT clearly on the approach rather than the method end of the spectrum.

Communicative Language Teaching has spawned a number of offshoots that share the same basic set of principles, but which spell out philosophical details or envision instructional practices in somewhat diverse ways. These CLT spin-off approaches include The Natural Approach, Cooperative Language Learning, Content-Based Teaching, and Task-Based Teaching.

It is difficult to describe these various methods briefly and yet fairly, and such a task is well beyond the scope of this document. However, several up-to-date texts are available that do detail differences and similarities among the many different approaches and methods that have been proposed. (See Larsen-Freeman, and Richards and Rodgers.) Perhaps it is possible to get a sense of the range of method proposals by looking at a synoptic view of the roles defined for teachers and learners within various methods. Such a synoptic (perhaps scanty) view can be seen in the following chart.

Teaching Methods and Teacher and Learner Roles		
Method	Teacher Roles	Learner Roles
Situational Language Teaching	Context Setter Error Corrector	Imitator Memorizer
Audio-lingualism	Language Modeller Drill Leader	Pattern Practicer Accuracy Enthusiast
Communicative Language Teaching	Needs Analyst Task Designer	Improviser Negotiator
Total Physical Response	Commander Action Monitor	Order Taker Performer
Community Language Learning	Counsellor Paraphraser	Collaborator Whole Person
The Natural Approach	Actor Props User	Guesser Immerser

Figure 2. Methods and Teacher and Learner Roles

(From: *Language Teaching Methodology* by Theodore S. Rodgers, Professor Emeritus, University of Hawaii)

The **Total Physical Response (TPR)** teaching method is one in which students respond with physical activity to an increasingly complex set of commands. The students' physical activity responses signal their comprehension of the command. This is ideally suited for beginning language students, but can be adapted and made more complex for higher level students.

The **Natural Approach (NA)** promotes communicative proficiency by providing real-world, authentic experiences, and language experiences with meaningful contexts.

As suggested in the chart, some schools of methodology see the teacher as an ideal language model and commander of classroom activity, whereas others see the teacher as a background facilitator and classroom colleague to learners.

There are other global issues to which spokespersons for the various methods and approaches respond in alternative ways. For example, should second language learning by adults be modelled on first language learning by children? One set of schools (e.g., Total Physical Response, Natural Approach) notes that first language acquisition is the only universally successful model of language learning we have, and thus that second language pedagogy must necessarily model itself on first language acquisition. An opposed view (e.g., Silent Way, Suggestopedia) observes that adults have different brains, interests, timing constraints, and learning environments than do children, and

that adult classroom learning therefore has to be fashioned in a way quite dissimilar to the way in which nature fashions how first languages are learned by children.

Another key distinction turns on the role of perception versus production in early stages of language learning. One school of thought proposes that learners should begin to communicate, to use a new language actively, on first contact (e.g., Audio-Lingual Method, Silent Way, Community Language Learning), while the other school of thought states that an initial and prolonged period of reception (listening, reading) should precede any attempts at production (e.g., Natural Approach).

A Post-communicative Approach to Teaching and Learning International Languages

The diversity of methods and approaches that were described above may seem to suggest that what makes for good practice is a contested area. However, one finds that there is an increasing integration of ideas as to what constitutes effective and meaningful second language teaching and learning. Krashen's theory that second language learners "acquire" language skills in many of the same ways that first language learners develop linguistic knowledge has had an enormous influence on second language/international language theory and practice. Proponents of communicative approaches have had an equally powerful influence. In many ways, the contemporary international language teacher reflects a "post-communicative" approach to teaching. That is, their understanding of the teaching and learning draws significantly on communicative theory but incorporates other theoretical perspectives, such as multiple intelligences and constructivist theories.

Communicative Language Teaching*

Renate Schulz provides a historical background and description of Communicative Language Teaching (CLT). In the 1970s and 1980s, second/international language instruction moved away from an almost exclusive focus on the components of language—grammar, vocabulary, and pronunciation—to a focus on the development of communicative proficiency—the ability to communicate in the target language (language being studied) in real-life contexts. Communicative language teaching builds on the understanding that language use is governed not only by phonological and grammatical rules, but also by sociolinguistic and discourse rules (Canale and Swain). In other words, natural language use is a complex, creative activity that takes different

* Adapted from "Foreign Language Education in the United States: Trends and Challenges" by Renate A. Schulz.

forms depending on a variety of factors, including the context in which the interaction occurs, the characteristics of the speaker or writer (e.g., age, gender, social status, level of education, and geographic origin), the characteristics of the listener or reader, and the purpose of the interaction (Hymes).

Whereas previous second/international language teaching methods—such as the grammar translation and audio-lingual methods—focused predominantly on grammatical form within a sentence-level context (or sometimes without any meaningful context), communicative language teaching focuses on the meaning of a message within a given situation, realizing that different cultures may have different ways to perform different speech acts in different contexts. It is the context that determines what is said, how it is said, to whom it is said, and why it is said. Thus communicative language teaching often uses language functions or speech acts (e.g., asking questions, apologizing, complimenting, reporting, giving directions, and making requests), rather than specific grammatical structures, as its organizing principles.

With the communicative language teaching approach, teachers and students use the target language extensively, if not exclusively. Students are given information-exchange tasks that they can complete by working in pairs or small groups. This interactive, situational language practice requires learners “to interpret, express, and negotiate meaning in the new language” (Lee and VanPatten 1).

Communicative language teaching also advocates the use of culturally authentic texts written by native speakers for native speakers instead of simplified or edited texts developed expressly for second/international language learners. Effective use of authentic texts includes having the learners perform interesting and level-appropriate tasks after or while seeing, hearing, or viewing culturally authentic materials. For example, it would be inappropriate to give beginning learners a newspaper editorial and ask them to translate or summarize its content. However, even beginning learners can find dates and names of persons or places and can often get the general sense of what is being said.

Although discrete-point grammar instruction, mechanical pattern practice, and instant and direct error correction—which dominated second/international language instruction in the past—are generally frowned upon in the communicative classroom, attention to grammatical patterns continues to play an important role. This is true particularly for adolescent and adult learners, who are often intrigued by—and find it helpful to understand—structural differences between their own and the target language. The role of grammar is to support the exchange of meaning, the informational contents, and the communicative purposes dealt with in the classroom.

Constructivist Theory

Constructivist theory emphasizes the importance of the learner's active construction of knowledge and the interplay between new knowledge and the learner's prior knowledge. Effective international language instruction will provide opportunities for students to construct and create their own understanding of how to make meaning from what they hear and read, and how they use their understanding to construct and create their own meanings in speech and writing. Myriam Met ("Middle Schools") describes a constructivist approach to the learning of international languages in the text that follows:

In order to construct knowledge of a new language, students need exposure to the target language. This exposure makes the transmission of meaning in second languages accessible and understandable to students. Internalizing the relationship between meaning and the forms used to convey it is essential for production; students cannot spontaneously produce language they do not understand. In the first phase of internalization, students learn to understand what is heard by matching meaning with language. Learners need to notice features in the input (vocabulary, syntax, discourse markers) to which they can assign meanings. Through a carefully implemented sequence of instructional activities, students can be assisted to move through the construction of meaning. Students should be provided with comprehensible examples of new structures as used in authentic situations and extended spoken and written texts, as well as many opportunities to hear, understand, and match language with meaning.

Characteristics of Effective Programs

It is well known that almost all young children acquire their first language naturally in the course of normal development and that they can acquire a second language simultaneously if their second language environment is similar to that of their first language environment. Numerous research studies have shown that adolescents and young adults can be quite efficient language learners (again with the exception of acquiring native-like pronunciation) in situations in which exposure to the language is limited to a classroom setting. As Swain and Lapkin ("Canadian Immersion") point out, "Older learners may not only exhibit as much success in learning certain aspects of a second language as younger learners, but they can also accomplish this learning in a shorter period of time" (150).

There are several factors or characteristics of effective second/ international language programs. In a review of the international literature on effective languages programming, Pufahl, Rhodes, and Christian (*Other Countries*) identified and summarized a number of additional factors or characteristics of successful program models.

An Early Start

As can be expected, time is a factor. Many international respondents reported that beginning language study early promotes achievement of higher levels of language proficiency. Seven of the countries that were studied have widespread or compulsory education in second/international languages by age eight, and another eight countries introduce second/international languages in the upper elementary grades. In many cases, a second second/international language is offered or required in the elementary grades. What is essential for the development of a lasting and usable competence in a second/international language is a lengthy, well-articulated, high-quality instructional sequence. This means that if language proficiency is the major goal of instruction, then the length of formal language study needs to be four years or more.

A Well-Articulated Framework

Instruction must be well-articulated in a continuous, sequentially planned and executed curriculum through which students progress without interruption from the beginning of their second/international language study to high school graduation. Several respondents noted the importance of a well-articulated curriculum framework that motivates and guides the development of an effective system of second/international language education. Many European countries have adapted their second/international language teaching at the national level to the frameworks and standards articulated by the Council of Europe's language policy and activities. *A Common European Framework of Reference for Languages*, developed and revised over the past decade, has had high impact. The *Framework* is a planning instrument that provides a common basis and terminology for describing objectives, methods and approaches, skills, practices, and assessments in language teaching, and it is used for planning syllabuses, examinations, teaching materials, and teacher training programs throughout Europe.

Similar developments have emerged in Canada and the United States. *The Western Canadian Protocol, Common Curriculum Framework for International Languages* (2000) was an attempt to improve the effectiveness of international language education in western Canada by providing a common well-articulated framework for the development of language-specific curriculum.

Rigorous Teacher Education

One of the most often cited factors related to excellence in second/international language education is a well-trained teaching corps.

Comprehensive Use of Technology

Innovative technologies and media are frequently cited as a way to increase access to information and entertainment in a second/international language, provide interaction with speakers of other languages, and improve second/international language teaching in the classroom.

Access to Information and Entertainment

Most respondents, in particular those from Canada, Denmark, and Thailand, highlighted the importance of the Internet and specialized databases for information retrieval. In smaller countries, many television shows are broadcast in a second/international language and subtitled rather than dubbed. In Denmark, where English is omnipresent through the many American and British television programs, films, computer games, and music videos, teachers have developed successful strategies for integrating students' informal second/international language exposure into classroom teaching.

Interaction and Collaboration with Speakers of Other Languages

Access to information on the World Wide Web and the use of new information technologies, especially networked computers, has contributed to increased communication among second/international language teachers and students in many countries. Through email, mailing lists, discussion groups, and chat rooms, the Internet has increased access to and communication in the second/international language with both native and non-native speakers.

In addition, improvements in travel and reduced costs have made it possible for increased direct contact through tourism, education, and business/work-related activities. Satellite communication and improvements in telecommunication have brought the "world" into homes throughout the world, no matter how remote. Multilingual television channels have increased the linguistic diversity in every nation.

Effective Teaching Strategies

Respondents mentioned several innovative methods for language instruction, which fall roughly into the categories highlighted below.

Integration of Language and Content Learning

Learning content-area subjects through the medium of a second/international language has become increasingly popular in many of the responding countries. In some cases, a second/international language is used as the medium of instruction in non-language subjects, frequently at the secondary school level when students have acquired sufficient proficiency in the second/international language. In Luxembourg, for example, both German and French are used as a medium of instruction throughout students' school careers to support simultaneous learning of both languages. In immersion programs, called "bilingual programs" in Europe, primary school children are taught subject matter almost exclusively in a second or international language. Similar bilingual and French immersion programs in Canada have demonstrated the possibilities and effectiveness of each model.

Communicative Teaching Methods

In Denmark, Germany, the Netherlands, New Zealand, Peru, and Spain, a focus on communicative and intercultural learning has not only stimulated a productive discussion of teaching objectives, methods, and underlying rationales that are now reflected in curricula and textbooks, but has also resulted in increased oral and written proficiency for their students.

Focus on Language Learning Strategies

Several respondents reported that a recent focus on how to learn a second/international language has been important to the success of language education in their countries. In Denmark, for example, teachers focus on raising students' awareness of various communication strategies, including strategies to bridge vocabulary gaps, reading and listening strategies, and general language learning strategies.

Building on the First or Subsequent Languages

There is increasing awareness and knowledge of the importance of the students' first language on second language learning. Successful approaches consider students' first languages as a foundation upon which to build second language proficiency. In Luxembourg, several projects demonstrate that acknowledging the sociocultural context and the already developed competencies of children in their first language will boost learning of subsequent languages.

Other Characteristics of Successful Programs

Other notable methods include the sole use of the second/ international language in the classroom; a modular approach to teaching in which students are grouped according to proficiency level rather than age or grade level; and project-oriented learning that emphasizes the use of authentic materials through technology and integrates learning about culture and nations with language and content learning.

The Influence of Contemporary Theory and Practice on the WNCP

The research summarized in the preceding section has informed the development of the WNCP *Spanish Language and Culture, Four-Year High School Program: Implementation Manual*. In developing this document, developing communicative competence has been at the forefront of the enterprise. Both the curriculum framework and the suggestions for instruction and assessment included in this manual demonstrate an acute awareness of the importance of meaningful and relevant learning experiences and tasks, which provide a context for acquiring and using Spanish.

Four Components

Communicative competence is represented by four interrelated and interdependent components. The “Applications” component deals with what the students will be able to do in Spanish, the functions they will be able to perform, and the contexts in which they will be able to operate. “Language Competence” addresses the students’ knowledge of the Spanish language and their ability to use that knowledge to interpret and produce meaningful **texts*** appropriate to the situation in which they are used. “Global Citizenship” aims to develop intercultural competence with a particular focus on Spanish cultures. The “Strategies” component helps students learn and communicate more effectively and more efficiently. Each of these components is described more in the *The Common Curriculum Framework for Spanish Language and Culture, Four-Year High School Program* and also in this document.

Modes of Communication

Because of the focus on using language to communicate in specific contexts, with a particular purpose or task in mind, three modes of communication are used to organize some of the specific outcomes rather than the traditional language arts (reading, writing, listening, speaking, viewing, representing).

* See Appendix A: Glossary for definitions of terms.

Interaction is most often direct, face-to-face oral communication. It can also take the form of written communication between individuals using a medium such as email where the exchange of information is fairly immediate. It is characterized principally by the opportunity to negotiate meaning actively. Negotiating meaning involves working to make oneself understood and to understand others. Interactive communication generally requires more speed but less accuracy than the other two modes.

Interpretation is receptive communication of oral and written messages in contexts where the listener or reader is not in direct contact with the creator of the message. While there is no opportunity to ask for clarification, there is sometimes the possibility of rereading or listening again, consulting references, or figuring out meaning in other ways. Reading and listening will sometimes involve viewing and interpreting visual elements such as illustrations in books or moving images in television and film. Interpretation goes beyond a literal comprehension to include an understanding of some of the unspoken or unwritten meaning intended by the author or speaker.

Production is communication of oral and written messages in contexts where the audience is not in personal contact with the speaker or writer, or in situations of one-to-many communication (e.g., a lecture or a performance where there is no opportunity for the listener to interact with the speaker). Oral and written presentations will sometimes be enhanced by representing the meaning visually, using pictures, diagrams, models, drama techniques, or other non-verbal forms of communication. Greater knowledge of the language and culture is required to ensure that communication is successful because the participants cannot directly negotiate meaning.

Viewing and Representing

It is common in Canada to conceptualize language arts as comprising six elements (reading, writing, speaking, listening, viewing, and representing). While the six language arts cannot be separated in a real sense in the classroom, viewing and representing are discussed separately here because they have been formally identified as language arts in this curriculum.

Many students are avid and sophisticated consumers of visual media, and their familiarity with visual forms may facilitate literacy with other forms. Teachers can make use of this knowledge by creating links between conventions in visual media and similar conventions in written texts.

Viewing and representing are language arts in their own right. Students need to learn the techniques and conventions of visual language to become more conscious, critical, and appreciative readers of visual media, and more effective creators of visual products.

Films and video productions increase students' experiences, much as written texts do, and they offer similar opportunities for discussion. Films also provide rich opportunities to explore the similarities and differences between visual and written language. Students may enhance their own products and presentations by using visuals with written text and/or sound.

Students may use visual representation for both informal and formal expression. Drawing or sketching may, in fact, be the first and most natural way for some students to clarify thinking and generate ideas. They may also use tools such as frames, maps, webs, and other graphic organizers to comprehend parts and their relationships. Visual tools are especially useful because they can represent the non-linear nature of thought and show relationships among ideas. For beginning learners of Spanish Language and Culture, visual tools may be an effective way to facilitate and demonstrate comprehension.

Students may use representation to express their mental constructs of the ideas, theories, or scenes in written texts. Events, ideas, and information may be depicted in graphic organizers, storyboards, murals, comic strips, or collages. After studying visual media, students make informed use of design elements in developing charts, slides, posters, and booklets. Other creative forms of expression, such as music, drama, dance, or mathematics, can be a means of representing students' understanding of a topic or a concept. The inclusion of representing as a language art extends the means by which students can communicate and demonstrate their learning in authentic ways.

Three Types of Language Learning

As students actively use the language arts, they engage in three kinds of language learning:

- Students learn language: Language learning is a social process that begins in infancy and continues through life. Language-rich environments enhance and accelerate the learning process.
- Students learn through language: As students listen, read, or view, they focus primarily on making meaning. Students use language to increase their knowledge of the world.
- Students learn about language: Knowledge of how language works is a subject and a discipline in itself and is fundamental to effective communication.

These three kinds of language learning are integrated in the classroom. Students may engage in learning tasks principally to make sense of the world. In the process of learning through language, however, their facility with language and their knowledge about language increases.

Developing Language Competence

Language competence is a broad term which includes not only knowledge about the language, but also the ability to use that knowledge to interpret and produce meaningful texts appropriate to the situation in which they are used. Language competence is best developed in the context of activities or tasks where the language is used for real purposes, in other words, in practical applications. Tasks involve students in understanding, manipulating, producing, or interacting in Spanish while their attention is principally focused on meaning rather than form. Activities or tasks will be chosen based on the needs, interests, and experiences of students. The vocabulary, grammar structures, text forms, and social conventions necessary to carry out the task will be taught, practised, and assessed as students are involved in various aspects of the task itself, not in isolation.

Teaching the Form of the Language

Teaching the form of a second language has been the topic of much discussion but there is still a need for more research to clarify many issues that remain unresolved. However, we can make the following observations with some certainty:

- Exposing students to the language without explicitly teaching its structures and formal properties is not enough to enable most students to become fluent.
- Teaching grammar through exercises that are unrelated to meaningful communication will not help students improve their language competence.
- Activities or tasks which focus on the form of the language should take up a relatively small part of the overall class time. The majority of classroom time should be spent on communicative activities, in other words, on activities where the focus is on meaning.
- Students cannot be expected to master a particular structure after a single lesson on it. They need to be exposed to the structure repeatedly, in a variety of situations, and have the opportunity to use it over an extended period of time before it will be learned.

How does the teacher decide when to introduce specific structures or forms? In programming that takes a task-based or content-based approach, the choice of grammar structures or forms to work on explicitly is based on the immediate needs of the students. In other words, students learn about the structures and forms they will need to use in order to carry out the task that is the focus of the unit. This way

of ordering the teaching of grammar requires a careful analysis of the tasks the students will work on to determine which structures are essential and in which context they will be used. With careful planning, the teacher can ensure that specific points are revisited regularly in a variety of contexts.

An effective method of raising the students' consciousness of particular structures or rules is to help them discover the rule themselves. Once they are aware of the structure, they will be more likely to notice it in texts they are working with and thus have their learning reinforced. Grammatical problem-solving activities (see page 68) can be used to help students discover patterns from a number of examples of correct and incorrect sentences. If students work in pairs or small groups and are able to do the activity in Spanish, they will also be getting an opportunity to use the language in an authentic situation, in this case to learn something new. Even if students do the activity in English and are guided by the teacher, they will still benefit from the analysis.

Structural exercises can be effective tools for teaching grammar provided they meet certain criteria:

- Sentences used for the exercises should be taken directly from students' own productions or from texts they are using in their communicative activities.
- Understanding the meaning of the sentence should be necessary in order to do the exercise.
- Students should have the opportunity to use the structure they have just analyzed to accomplish the task that is the focus of the unit.

See the section on Instructional Methods for more specific details and examples of structural exercises (page 51).

Teaching Aural Interpretation

Stephen Krashen's theory of second language acquisition (*Principles and Practice*) emphasizes the importance of comprehensible input. Students must hear the language spoken in situations which help them understand what is being said if they are to acquire the language. They may go through a "silent period" before being willing to try to use the language themselves, but this does not mean that they are not learning.

To maximize acquisition of the Spanish language, especially in the very early stages, input should have the following characteristics:

- Texts are as authentic as possible. (Authentic means they were produced for speakers of Spanish and not for second language learners.)
- Speech is slower and more clearly articulated, although not distorted.

- Syntax is simple, sentences short.
- High frequency vocabulary is used.
- The meaning is clarified by the use of gestures, facial expressions, visuals, or concrete objects.
- The topic is familiar to the student.
- The content is interesting and/or relevant to the student.

As students become more proficient, the language to which they are exposed can more closely resemble the normal speech of a native speaker and the non-verbal supports can be reduced. In order for students to continue to learn, input should always be just a little beyond their current capabilities.

Since the Spanish classroom may be the only place students are exposed to the language, it is important that Spanish be used as much as possible. Students can gradually be taught the vocabulary and structures needed to carry out classroom routines in Spanish, until the whole class is taking place in the second language.

Teaching Oral Production

Oral production activities are distinct from activities where there is interaction (and the possibility of negotiation of meaning) between individuals. Even though they are not interactive, they must still be communicative. This means that they will have the following characteristics:

- The topic is interesting and/or relevant to the students.
- The student producing the text has a **real** purpose (e.g., sharing factual information, expressing a personal opinion).
- The text is presented to a **real** audience (a person or persons other than a teacher who is listening for the sole purpose of teaching and assessing the student).
- **Real** communication takes place; in other words, the audience does not already know what the speaker is telling them.
- The students presenting the text usually have an opportunity to plan and prepare what they are going to say beforehand and to rehearse their presentation. For this reason, greater accuracy, better pronunciation and intonation, and greater fluency can be expected than in interactive situations.

Developing Interactive Fluency

Research has shown that students need more than comprehensible input to learn a second language. They also need output; in other words, they need opportunities to interact with others and to try to make themselves understood, if they are to develop accuracy and fluency. Producing language helps learners to notice gaps in their knowledge and then to try to find the correct form, in order to be understood.

Studies have also shown that nearly two-thirds of the talking that goes on in classrooms is done by the teacher. This is rather alarming when we know that interaction is essential for learning a language. If the teacher controls dialogue by asking questions of one student at a time, each individual student will have very little opportunity to try out new vocabulary and structures. Students must have the opportunity to interact in Spanish in authentic situations as much as possible.

Face-to-face interaction is different from other situations (e.g., reading a story, writing a letter, listening to a song, speaking to a group) in that negotiation of meaning is possible. The speaker knows more or less immediately whether or not the message has been understood. The conversational partner may indicate lack of understanding, ask for clarification, or simply respond, thinking they have understood. This back and forth process continues until a mutual understanding has been reached.

However, interactive activities, if they are to be effective, cannot be left to chance. They must be carefully planned and structured. Here are some suggestions:

- By using cooperative mixed-level groups, the teacher provides students with many opportunities to express themselves, to use the language in communicative situations, and to test their ability to get their message across. It is important to teach and assess cooperative skills related to using the Spanish language in cooperative groups. A more detailed description of cooperative learning can be found in the section on instructional methods (page 72).
- Students can be taught strategies for making themselves understood, without having recourse to English, when they don't know or cannot remember a word or phrase. Strategies include using gestures, synonyms, paraphrasing, looking at word lists posted in the classroom, and so on. See the list of interactive strategies in Appendix E, page Appendices – 35.

- Students often need to be encouraged to be a little more precise, a little more accurate. However, in interactive activities the focus should remain on the meaning the student is trying to convey. It is possible to respond to the message and yet push students to improve their language. If they are using a general word, for example, respond to what they are saying while at the same time using a more precise word. If they make a mistake in grammar or pronunciation, respond to the content (the meaning) of their message, but incorporate the correct structure or pronunciation into your response. If the idea is vague or very general, ask students to provide more details, justify their opinion, or be more precise.
- Students can learn to use similar techniques in their interactions with their fellow students. This involves strategies like asking questions to get more information or a clearer answer, indicating when one has not understood, or repeating what was said in a different way to check for understanding.
- None of these suggestions will work unless the classroom provides a safe environment for students, an environment where they know they can make mistakes without being ridiculed or punished. Students need to understand that taking risks (trying out new vocabulary and structures, using language that they are not quite sure of, trying to say things they want to say but have not yet learned fully) and making the inevitable mistakes are part of the process of effective language learning.

Teaching Written Interpretation

Students learning to read Spanish at the middle or secondary level have the advantage that they already know how to read in their first language and can transfer many of their skills and strategies to the task of reading Spanish, their second or additional language. The alphabet is the same. Students already understand that a written text has a message and that it is made up of individual words. They know that they don't always have to understand every word, they can read ahead and come back, or they can just guess at the meaning of words they don't know, and so on.

Since written language is a source of comprehensible input in the same way that oral language is, much of what was said about aural interpretation above is true of written interpretation as well. Written texts used in the early stages of learning Spanish should have the following characteristics:

- They are as authentic as possible. (Authentic means they were written for speakers of Spanish and not for second language learners.)

- Syntax is simple, sentences are short, texts are also short or made up of short sections.
- High frequency vocabulary is used.
- The meaning is clarified by the use of illustrations and other contextual clues.
- The topic is familiar to the student.
- The content is interesting and/or relevant to the student.

As students become more proficient, the written texts to which they are exposed can more closely resemble the normal language of a native speaker with fewer visual supports. In order for students to continue to learn, input should always be just a little beyond their current capabilities.

The term “written interpretation” is a reminder that the objective of reading is to interpret the meaning of the text. Activities such as reading aloud, while they have their place in the second language classroom, are more suited to practising good pronunciation or learning the correlation between sounds and spelling than to developing comprehension. For beginning readers of Spanish it is difficult to attend to the meaning of a text at the same time as the sound-symbol system.

Teaching Written Production

Research on teaching writing shows that student achievement is higher when the teaching approach emphasizes writing as a **process**, rather than writing as a **product**.

In the traditional **product-oriented approach**, form and correctness are the focus of attention. The teacher provides drills on specific skills, makes many of the major decisions for the students (e.g., topic, length, what form the text will take), and is the only audience. Students are asked to concentrate on following rules, to work alone, and to constantly pay attention to technical matters such as grammar and spelling. They usually write only one version of the text, which the teacher corrects. Because no one else will read the writing, students often pay little attention to the teacher’s comments.

Research has clearly shown that a concentration on grammar actually slows students’ development as writers because the insistence on correctness reduces their willingness to experiment and invent. Grammar instruction that relates directly to students’ writing, and is in response to their needs, is effective in improving writing.

The experience of classroom teachers and research conducted during recent years shows that a **process-oriented approach** to teaching writing is more successful. In this approach, students are led through a series of stages in their writing and gradually learn to use this process independently.

Strategic Learning in Spanish Language and Culture

Fostering strategic learning in the Spanish Language and Culture classroom is essential for ensuring effective and lifelong learning. To develop high levels of language skills, including literacy, students need instruction in the strategies that skillful learners use in approaching language tasks. Students need to be taught learning strategies through demonstration, explicit instruction, guided practice, and independent practice with feedback and support. Therefore, students in the WNCP Spanish Language and Culture Four-Year High School Program are encouraged to acquire and apply a wide range of strategies to enhance their learning and their ability to communicate effectively.

Strategies are systematic and conscious plans, actions, and thoughts that learners select and adapt to each task. Strategies are often described as knowing what to do, how to do it, when to do it, and why it is useful. The Spanish Language and Culture Program of Studies includes clusters of specific outcomes designed to promote three types of strategic learning in the Spanish Language and Culture classroom: language learning strategies, language use strategies, and general learning strategies.

Language learning strategies refer to actions taken by learners to enhance their own language learning. These strategies are subdivided into three categories: *cognitive*, *metacognitive*, and *social/affective*.

Cognitive language learning strategies operate directly on the language. These include such strategies as using different techniques for remembering new words and phrases, deducing grammar rules or applying previously-learned rules, guessing at the meaning of unknown words, and using a variety of ways to organize new information and link the new information to previously-learned language.

Metacognitive language learning strategies are higher order skills that students use to manage their own learning. These include planning for their language learning, monitoring their own language learning, and evaluating their success in language learning.

Social language learning strategies are actions learners take that involve interactions with native speakers of the Spanish language or interactions with other learners of Spanish in order to assist or enhance their own language learning. For example, asking another student for help to understand a text written in Spanish, or asking a native speaker for an unknown vocabulary item would be social language learning strategies.

Affective language learning strategies are methods students use to regulate their emotions, motivation, and attitudes to make themselves more conducive to learning.

Language use strategies are actions taken to enhance communication. These strategies are often used with no intention of trying to acquire language, but instead with the intention of improving communication. The language use strategies in *The Common Curriculum Framework for Spanish Language and Culture, Four-Year High School Program* are organized according to the three communicative modes: *interaction, interpretation, and production*.

General learning strategies refer to actions taken by learners to enhance their own general learning. As with language learning strategies, general learning strategies are divided into three sub-categories: *cognitive, metacognitive, and social/affective*. There is a distinctive similarity between language learning strategies and general learning strategies; the determining difference, however, is whether the purpose of the application of the specific strategy is the learning of the language or of other concepts. Often, the other concepts include subject-area concepts, such as social studies or health concepts.

The strategies that students choose depend on the task they are engaged in as well as on other factors, such as their preferred learning style, personality, age, attitude, and cultural background. Strategies that work well for one person may not be effective for another person or may not be suitable in a different situation. For this reason it is not particularly useful to say that students should be able to use specific strategies at a particular grade level. The goal is to help students become more active, more self-directed, more autonomous, and more expert in choosing the strategies that work best for them. Effective language learners tend to use more strategies and to apply them in a more appropriate fashion than less effective learners. A global list of strategies that will benefit students can be found in Appendix E of this document.

Strategies should be introduced as they are needed. When strategies are introduced and explained in terms of their value to the learner and are demonstrated and practised over time, they can produce long-lasting, significant improvements in the students' ability to construct meaning, acquire language, and achieve the Spanish Language and Culture outcomes. All students benefit from strategic instruction, but individual students need varying degrees of support in learning and using strategies.

Inclusive Teaching Approaches

Every classroom is a diverse classroom. Students bring with them a rich array of cultural backgrounds, learning styles, personal interests, and characteristics. It is important for teachers to consider the needs of all the learners in the classroom. The charts that follow provide an overview of points to consider and useful strategies for adapting instruction for diverse students.

Balanced Instruction in Spanish Language and Culture

Planning for balance while ensuring sufficient instruction and practice in all the outcomes defined for a particular grade is a particularly challenging task. Teachers strive to incorporate a variety of instructional strategies and teaching and learning activities in their classrooms. This includes varying instructional groupings and methods to meet the learning needs of a wide range of students.

Teachers also strive to ensure balance in their delivery of the curricular outcomes. They are attentive to the need for integrating the Application, Language Competence, Strategies, and Global Citizenship outcomes to achieve balanced instruction. They are careful to provide instruction in linguistic elements, such as grammar or vocabulary, within the context of concrete applications.

Themes, integrated units, and learning sequences provide opportunities for explicit instruction in many outcomes. Instructional activities such as mini-lessons are necessary to introduce, develop, or reinforce particular skills. In every planning decision, reflective teachers ask:

- What is an appropriate balance for my students?
- Am I achieving that balance in my classroom, both in the short term and the long term?
- Is my instruction helping students to achieve the appropriate outcomes of the Spanish Language and Culture Program of Studies?

Teachers strive for balance in their classrooms. A communicative approach requires the teacher to be a guide and a language model. One of the main functions of the teacher is to discover or invent ways of encouraging students to communicate meaningfully with each other. Instead of actively directing and controlling all activities, the teacher will set up conditions for meaningful practice, and then take on roles such as observer, facilitator, resource person, catalyst, challenger, and encourager.

Teachers also endeavour to provide a range of learning materials and resources. It is important to provide many opportunities for students to interact with a wide range of oral, literary, and media texts, from varied sources. See Sample List of Text Forms in Appendix B.

A balance between classroom-centred experiences and real-life, authentic applications of the Spanish language focused outside the classroom is essential in preparing Spanish Language and Culture students for the world beyond the Spanish classroom. This can be achieved through a wide range of activities, such as interactions with guest speakers and other visitors from outside of the school community, pen pal experiences, exploring Internet sites, viewing Spanish television or film productions, etc. Similarly, students must be provided with a wide range of opportunities for using the Spanish language in meaningful ways.

Adaptation Strategies

“Differentiating the curriculum” refers to adjustments in content, teaching strategies, expectations of student mastery, and scope and sequence. The students work at different paces. Gifted students are more likely to develop study and production skills, experience success, and feel challenged by instruction that encourages learners to master information more quickly. General adaptation strategies to ensure success with these learners are found on page 35.

Strategies for the International Language Classroom

Suggested student adaptation strategies for the international language classroom may include, but are not limited to, the following:

- researching and discussing cultural issues/perspectives in more depth
- posing questions that involve inferencing and focusing on complex cross-curricular themes or global problems
- explaining reasons for taking a certain position or making a specific decision both orally and in writing in Spanish

- creating original songs, stories, short plays, poems, designs, etc., showing multicultural perspectives of a specific theme or having a futuristic twist
- being held accountable for additional listening comprehension tasks
- creating experiences and performances that reflect the results of research, interviews, or surveys in the target language
- retelling a story or experience from other content areas in the target language
- writing editorials, letters, etc. to Spanish newspapers in the United States
- emailing articles, commentaries, reviews, etc. to Spanish schools, publications, organizations, newspapers, or magazines
- being given assignments involving more sophisticated computer research and reporting in the target language
- receiving handouts, information for web searches, etc. in the target language
- processing a greater volume of any given print material
- being given the option of independent world language projects of choice

Adaptation Strategies For Selected Scenarios

“Making Connections”

- Based on the scenario interview, write an essay in Spanish projecting the guest speaker’s future. Focus on further development of vocabulary related to that career. Present orally as a commentary on the guest’s class visit.
- Write a prospective business plan for the guest based on knowledge of the speaker’s current business and the Spanish-speaking culture. Email the plan to the speaker.

“You Are What You Eat”

- Create a catering business in a Spanish-speaking country. Plan meals for business conferences and typical celebrations in the Spanish culture. Include prices and optional services offered.
- Create a new recipe for a Spanish-speaking culture that satisfies certain criteria (e.g., seasonal dishes, diet dishes, or a dish that might appeal to target culture teens).
- Do an independent project in related areas (e.g., manners for a changing society, diseases related to food consumption, or emotions associated with certain foods in a Spanish-speaking culture/ country).

“Dare to Say No”

- Create a perfect teen/parent for a Spanish-speaking culture. The “ideals” will be based on what the student considers to be the best resolutions to the problems identified as a result of the scenario activity.
- Create a support group for teens based on problems identified and act as “facilitator” for the group.
- Direct and produce a TV talk show entitled “Parents & Teens Around the Globe.” Students role-play parent and teen guests.

Types of Adaptations

Three types of adaptations for exceptionally able learners—acceleration, enrichment, and grouping—are described in this section.

Acceleration

Acceleration involves grade-skipping or changing the rate of presentation of the general curriculum to enable the student to complete the program in less time than usual. Prescribed seat-time is not necessary for achievement of the outcomes. Acceleration can occur in any subject area. Middle school students should be able to take high school courses; high school students take college courses with appropriate credit accrued. Some provision must be made for continued acceleration or high-level enrichment. Unless the student has a pre-identified problem, social or emotional development should not inhibit acceleration.

The following are some examples of accelerated types of programs:

- **Flexible Pacing:** Assignment to classes should be based on the ability to be challenged and handle the work, not on age.
- **Content Acceleration:** Superior performance in some areas may be addressed with placement in a higher grade level for the areas warranting it.
- **Multi-Age Classes:** Classes can be formed in which two or more grade levels are combined. Students can accelerate through self-pacing.
- **Compacting** (also known as telescoping): This refers to a form of acceleration in which part of the curriculum is addressed in a shorter period of time than is usual. Previously mastered content material is determined through pre-evaluation and eliminated.

- **College Course Work:** Qualified students take college courses for college credit while completing high school requirement (concurrent enrollment). College courses may be taken in the summer.
- **Early College Admission:** Once all high school graduation requirements are met, early admission to college is an option.
- **Advanced Placement:** The advanced placement program (APP), administered by the College Entrance Examination Board, enables high school students to obtain both high school and college credit for demanding course work offered as part of the school curriculum.

Enrichment

Enrichment is another way to meet the differentiated needs of exceptionally able students. Well-articulated assignments that require higher cognitive processing, in-depth content, and alternate modes of communication can be effective and stimulating.

The following are some examples to consider when differentiating classroom instruction to meet the needs of academically or artistically talented students:

- **Alternate Learning Activities/Units:** Opportunities to pursue alternate activities permit students to engage in new learning and avoid the boredom of repeating instruction or unnecessary practice in skills already mastered.
- **Independent Study:** Students conduct well planned, self-directed research projects carefully monitored by the teacher. Prerequisites include instruction in field-based and library research skills, the scientific method, and other authentic types of inquiry.
- **Advanced Thinking Processes:** Assignments in all curriculum areas should emphasize higher-level thinking skills such as synthesis, analysis, and evaluation.
- **Guest Speakers:** University faculty, parents, business and industry leaders, or other teachers in specific fields can provide information on topics beyond the teacher's expertise.
- **Mentors/Internships:** Both mentors and internships allow students to interact with adult experts in fields of mutual interest and increase awareness of potential careers. Mentors act as role models.
- **Alternate Resources:** This category may include materials from a higher grade level or access to business, university, and community resources such as laboratories, libraries, and computer facilities.

- **Exchange Programs:** Students attend schools in a different community or country to enrich educational experiences.

Grouping

Grouping involves placing students of like ability together in homogeneous arrangements such as special classes or clustering in the same classroom. Grouping allows for more appropriate, rapid, and advanced instruction and challenges students without isolating them.



Students may be grouped using the following arrangements:

- **Pullout Programs:** These programs combine regular class integration and homogeneous grouping on a part-time, regular basis. Pullout programs require careful coordination and communication between the teachers of both classes.
- **Cluster Grouping in the Regular Classroom:** This type of grouping permits homogeneous and heterogeneous grouping according to interests and achievement.
- **Cluster Scheduling:** Schedules are arranged so that exceptionally able students can take their required core courses together to enhance rapid pacing and provide greater depth and breadth to course content.
- **Honours and Enriched Classes:** These classes provide opportunities for practising higher-level thinking skills, creativity, and exploration of in-depth course content.
- **Seminars:** Aimed at research, interdisciplinary studies, visual and performing arts, academic subjects, or other areas of interest, seminars provide interaction with specialists who can give guidance in specific areas.
- **Resource Centres:** A district can establish a resource centre available to all students, but reserve it at times for exceptionally able students from a broader geographical area (e.g., inter-district).

Additional Adaptations



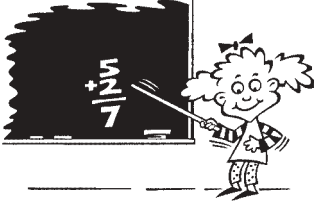

The following charts outline various strategies for adapting learning activities to accommodate students with diverse talents, exceptionally able students, and students with specific learning needs. Teachers may wish to refer to these during their instructional planning and as a check to be sure that they are using inclusive classroom practices.

STRATEGIES FOR STUDENTS WITH DIVERSE TALENTS

Intelligence	Students learn best by	Planning questions for teachers	Learning activities
<p>Linguistic</p> 	<p>Verbalizing, hearing, and seeing words</p>	<p>How can I use the spoken or written word?</p>	<p>Creative writing Formal speech Humour or telling jokes Impromptu speaking Journal or diary keeping Oral debate Poetry Storytelling Words—used in reading, writing, speaking</p>
<p>Logical-Mathematical</p> 	<p>Conceptualizing it, quantifying it, thinking critically about it</p>	<p>How can I bring in numbers, calculations, logic, classifications, or critical-thinking skills?</p>	<p>Abstract symbols, formulas Calculation Counting Deciphering codes Finding patterns Forcing relationships Graphic organizers Number sequences Outlining Problem solving Syllogisms</p>
<p>Spatial</p> 	<p>Drawing it, sketching it, visualizing it</p>	<p>How can I use visual aids, visualization, colour, art, or metaphor?</p>	<p>Active imagination Colour schemes Designs and patterns Drawing guided imagery Mind mapping Painting pictures Pretending Sculpture/models</p>
<p>Bodily-Kinesthetic</p> 	<p>Dancing it, building a model of it, doing a hands-on activity related to it</p>	<p>How can I involve the whole body or use hands-on experience?</p>	<p>Body language Dancing—folk or creative Drama/acting Inventing Martial arts Mime Physical gestures Physical exercises Playing sports and games Role-playing</p>

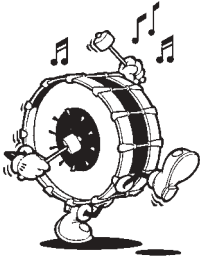
Adapted from the *Nebraska K-12 Foreign Language Frameworks*

STRATEGIES FOR STUDENTS WITH DIVERSE TALENTS (CONTINUED)

Intelligence	Students learn best by	Planning questions for teachers	Learning activities
<p style="text-align: center;">Music</p> 	<p>Singing it, chanting it, finding music that illustrates it, putting on background music while learning it</p>	<p>How can I bring in music or environmental sounds, or set key points in a rhythmic or melodic framework?</p>	<p>Creating music Environment sounds Humming Listening to music Music performance Music composition, creation Percussion vibrations Rhythmic patterns Singing Tonal patterns Vocal sounds and tones</p>
<p style="text-align: center;">Interpersonal</p> 	<p>Working on it with another person or group of people</p>	<p>How can I engage students in peer-sharing, cooperative learning, or large-group simulation?</p>	<p>Collaboration skills Cooperating Cooperative learning Empathy practices Giving feedback Group projects Intuiting others' feelings Listening Person-to-person communication Receiving feedback Sensing others' motives Talking to others Teamwork/division of labour</p>
<p style="text-align: center;">Intrapersonal</p> 	<p>Relating to a personal feeling or inner experience</p>	<p>How can I evoke personal feelings or memories, or give students choices?</p>	<p>Being alone Complex guided imagery "Centring" practices Emotional processing Focusing/concentration skills Higher-order reasoning "Know thyself" practices Metacognition techniques Mindfulness practices Silent reflection methods Telling about feelings Telling about thinking Thinking strategies</p>
<p style="text-align: center;">Naturalist-Physical World</p> 	<p>Observing it, classifying it, appreciating it</p>	<p>How can I relate the student's learning to the physical world?</p>	<p>Discovering, uncovering Observing, watching Forecasting, predicting Planting Comparing Displaying Sorting and classifying Photographing Building environments</p>

Adapted from the *Nebraska K-12 Foreign Language Frameworks*

STRATEGIES FOR STUDENTS WITH DIVERSE TALENTS

Multiple Intelligences Grid of Ideas The Olympic Games or Games of Life							
Verbal	Logical	Spatial	Bodily	Musical	Interpersonal	Intrapersonal	Naturalist
Biographies	Graphic arts	Greek architecture	Fitness	National songs	Teamwork	Individual achievement	Nutrition
Writing about heroes	Biochemistry	Pottery	Sports	Raps	Cooperation	Pride	Health
Historical fiction	Laws of physics	Painting	Practice	Practising music	Competition	Sense of accomplishment	Wellness
Myths	Statistics	Posters	Routines	Relaxation music	Sportsmanship	Logs	Biochemistry
Literature	Percentages	Photos	Regimens	Mediation	Coaching	Journals	Climate
News reporting	Logical thinking	Graphic organizers	Physical therapy	Composing	Mentoring	Psychology of peak performance	Culture
Expository writing	Sequences	Graphs	Conditioning	Performing	Global relationships		Biofeedback
Features	Cause/effect	Visualization techniques	Experiences	Selecting appropriate music	Conflict management	Endurance	Attitudes

Multiple Intelligences Grid of Life (Fogarty)

**STRATEGIES FOR STUDENTS WITH DIVERSE TALENTS
PLANNING MODEL USING BLOOM’S TAXONOMY**

Bloom’s Taxonomy is a model that focuses on six levels of thinking. The six levels roughly form a two-tiered arrangement that represents levels of complexity in thinking. Knowledge and comprehension are the lower or more concrete levels of thinking. Analysis, evaluation, and synthesis represent higher or more complex levels of thinking. The application level, which falls between the lower and higher levels, can be very complex depending on the task.

A variety of instructional strategies and products may be categorized for each level of thinking. Teachers who design a variety of learning activities that require different levels of thinking will provide appropriate opportunity for the diverse number of students whose thinking levels range throughout the spectrum.

The following chart provides a model for instructional planning based on Bloom’s taxonomy of thinking. Also see International Languages and Bloom’s Taxonomy on page 34.

Level		Definition	Instructional Strategies	Activities, Tasks, & Products
Lower, less complex, more concrete levels	Knowledge	Students recall information, recite, or write	<ul style="list-style-type: none"> • ask • define • describe • discover • identify • label • list • listen • locate • match • memorize • name • observe • recite • recognize • remember • research • select • state • tell 	<ul style="list-style-type: none"> • books • diagrams • events • exams • facts in isolation • films • film strips • magazine articles • models • newspapers • people • plays • quiz • radio • recordings/records • tapes • tape reading • vocabulary • workbook pages
	Comprehension	Students restate the information in their own words	<ul style="list-style-type: none"> • ask • change • compare • convert • defend • discover • distinguish • edit • explain • express • extend • generalize • give example • identify • illustrate • infer • interpret • listen • locate • match • observe • paraphrase • predict • relate • research • restate • rewrite • show symbol • summarize • transform • translate 	<ul style="list-style-type: none"> • causal relationship • comparison of like/unlike items • conclusion/implication based on data • diagrams • films • filmstrips • graph • magazines • models • newspapers • outline • own statement • people • photograph • radio • response to questions • revisions • skit • speech • story • summary • tape recording • television

Adapted from the *Nebraska K-12 Foreign Language Frameworks*

STRATEGIES FOR STUDENTS WITH DIVERSE TALENTS (CONTINUED)
 PLANNING MODEL USING BLOOM'S TAXONOMY

Level	Definition	Instructional Strategies	Activities, Tasks, & Products	
Higher, more complex, more abstract levels	Application	Students apply the information in one or more contexts	<ul style="list-style-type: none"> • apply • build • change • choose • classify • construct • cook • demonstrate • discover • dramatize • experiment • interview • list • manipulate • modify • paint • prepare • produce • record • report • show • sketch • solve • stimulate • teach • use guides, charts, maps 	<ul style="list-style-type: none"> • artwork • collection • crafts • demonstration • diagram • diorama • diary • drama • forecasts • illustration • list • map • meeting • mobile • model • paint • photographs • project • puzzle • question • recipe • scrapbook • sculpture • shifting smoothly from one gear into another • solution • stitchery
	Analysis	Students understand component parts to be able to compare and contrast or categorize information	<ul style="list-style-type: none"> • advertise • analyze • categorize • classify • compare • contrast • differentiate • dissect • distinguish • infer • investigate • point out • select • separate • solve • subdivide • survey 	<ul style="list-style-type: none"> • argument broken down • chart • commercial • conclusion • checked • diagram • graph • parts of propaganda statement identified • plan • prospectus • questionnaire • report survey • report • solution • survey • syllogism broken down • word defined
	Synthesis	Students judge what they have analyzed and support their opinions	<ul style="list-style-type: none"> • combine • compose • construct • create • design • estimate • forecast • hypothesize • imagine • infer • invent • predict • produce • rearrange parts • role-play • write 	<ul style="list-style-type: none"> • advertisement • article • book • cartoon • experiment • formation of a hypothesis or question • game • invention • lesson plan • machine • magazine • new game • new product • new color, smell, taste • news article • pantomime • play • poem • puppet show • radio show • recipe • report • set of rules, principles, or standards • song • speculate on or plan alternative courses of action • story structure • television show
	Evaluation	Students create and/or gather pieces of information to form a novel thought, idea, product, or perspective	<ul style="list-style-type: none"> • appraise • choose • compare • consider • criticize • critique • debate • decide • discuss • editorialize • evaluate • give opinion, viewpoint • judge prioritize • recommend • relate • summarize • support • weigh 	<ul style="list-style-type: none"> • conclusion • court trial • critique • debate • decision • defense/verdict • discussion • editorial • evaluation • group discussion • group • letter • news item • panel • rating/grades • recommendation • self-evaluation • standard compared • standard established • survey • valuing

Adapted from the *Nebraska K-12 Foreign Language Frameworks*

STRATEGIES FOR STUDENTS WITH DIVERSE TALENTS
INTERNATIONAL LANGUAGES AND BLOOM'S TAXONOMY

Knowledge/ Comprehension	Application	Analysis	Synthesis	Evaluation
<p><i>What students will do:</i></p> <ul style="list-style-type: none"> • Write telegrams • Arrange lines of dialogues • Fill out authentic forms for the target country • Explain proverbs, slang • Listen for sequence • Explain the "What? Who? Where? How? Why?" • Give description of scenes from a video presentation • Describe pictures from the target country • Define words • Listen and paraphrase in English a conversation heard in the target language • Draw picture from verbal information of a target culture's scene or object 	<p><i>What students will do:</i></p> <ul style="list-style-type: none"> • Dub cartoons, TV shows • Command others step-by-step to prepare a typical cultural dish • Produce questions with correct pronunciation • Apply a cultural custom to a real-life situation in the target country • Interview classmates on their daily activities • Plan a menu for occasions typical of the target culture • Make shopping lists for various cultural, social events • Apply rules of correct cultural protocol while dining in the target country • Classify words, poems, authentic materials, genre • Apply gestures learned to an authentic situation • Apply reading strategies to understand authentic texts 	<p><i>What students will do:</i></p> <ul style="list-style-type: none"> • Identify elements of a particular literary form • Analyze the lyrics of popular songs to compare both cultures' perspectives • Compare points of view found in two editorials • Analyze a story, poem, and other authentic materials • Analyze a scene in the target culture • Find evidence to support opinion • Compare students' customs with the target culture's • Conduct a survey and analyze the results • Analyze the typical foods of the target country for nutritional value • Identify the best route to a historic site in the target country • Play the role of a tourist who bargains for merchandise in the target country 	<p><i>What students will do:</i></p> <ul style="list-style-type: none"> • Write an alternative ending to a story • Predict consequences if other historical events would have resulted differently • Write titles for a play, story, or article • Write headlines in newspaper style on current issues in the target country • Predict future events • Write a diary of an imaginary trip • Extend a story • Hypothesize the reaction to different situations based on the cultural beliefs • Compose a poem, skit, role play, advertisement • Create hypothetical real-world situations found in the target culture • Create an infomercial 	<p><i>What students will do:</i></p> <ul style="list-style-type: none"> • Prioritize solutions to cultural dilemmas • Express and justify opinions on creative products of the culture • Give and support opinions about issues • Evaluate TV shows, movies, cartoons • Write an editorial giving and supporting own opinion • Express the pros and cons of policies • Give and support the decision in a mock trial • Write an ambassador with suggestions for the resolution of a real-world problem • Justify decisions of sites to visit in the target culture • Read an editorial in a target-country newspaper; respond and send response • Evaluate best World Wide Web pages for source of current events in the target country

Adapted from the *Nebraska K-12 Foreign Language Frameworks*

STRATEGIES FOR EXCEPTIONALLY ABLE (GIFTED) STUDENTS

To ensure success *with exceptionally able students* ...

- ◆ allow for choice within assignments and projects.
- ◆ use compacting.
- ◆ allow students to make independent plans for independent learning.
- ◆ provide mentoring or apprenticeship with professionals.
- ◆ teach entrepreneurship.
- ◆ use theory of multiple intelligences.
- ◆ use tiered assignments which are more complex or abstract.
- ◆ use Socratic questioning.
- ◆ use critical and creative questioning strategies.
- ◆ use open-ended questioning strategies.
- ◆ use interdisciplinary units.
- ◆ allow in-depth enrichment learning.
- ◆ allow time with like-intellectual peers.
- ◆ use accelerated pace of instruction.
- ◆ allow dual enrollment or early admission opportunities.
- ◆ remove time and space restrictions to allow for a long-term integrated plan of study.
- ◆ provide more difficult or abstract resources.
- ◆ allow for concrete or real-life investigations and explorations.
- ◆ teach coping skills.
- ◆ allow students to suggest modifications in the content of their learning, the process which they use to learn, and the product they produce to show their learning.
- ◆ clearly communicate criteria and parameters to avoid students taking unacceptable risks or creative detours.

Adapted from the *Nebraska K-12 Foreign Language Frameworks*

STRATEGIES FOR STUDENTS WITH SPECIFIC LEARNING NEEDS
CONSIDERATIONS FOR MEETING SPECIFIC LEARNING NEEDS
IN SKILL AND INSTRUCTIONAL AREAS

To ensure success *with speaking* ...

- | | | |
|---|--|--|
| ◆ give sentence starters. | ◆ use cues and prompts to help the student know when to speak. | ◆ use choral reading or speaking. |
| ◆ use graphic organizers to organize ideas and relationships. | ◆ use partners. | ◆ use rhythm or music. |
| ◆ use visuals. | ◆ phrase questions with choices embedded in them. | ◆ allow practice opportunities for speaking. |
| ◆ allow extra response time for processing. | | ◆ practice role-playing activities. |

To ensure success *with assessment* ...

- | | | |
|---|--|---|
| ◆ use a variety of authentic assessments. | ◆ allow adequate time for test taking. | ◆ give choices. |
| ◆ establish criteria and expectations prior to instruction. | ◆ allow paper-and-pencil tests to be taken in a different space. | ◆ assess learning continuously over time, not just at the end of a unit of study. |
| ◆ teach test-taking strategies. | ◆ allow a variety of ways to respond (e.g., orally, pictorially, tape recordings). | ◆ use rubrics. |
| ◆ teach the format of an upcoming test. | | ◆ use self-assessment tools. |

To ensure success *when working in groups* ...

- | | | |
|--|--|---|
| ◆ teach group rules and expectations. | ◆ post rules and expectations. | ◆ teach a signal for getting attention of all groups. |
| ◆ teach skills of independence (e.g., bridging phrases, disagreeing agreeably, voice level). | ◆ give adequate time but not "fooling around" time. | ◆ practice and assess students' behaviors in small-group settings. |
| ◆ teach manageable strategies for moving in and out of groups within the classroom setting. | ◆ be in close proximity to groups as they work. | ◆ use cooperative learning strategies. |
| | ◆ teach students to self-monitor group progress. | ◆ use a wide variety of groupings (e.g., flexible, cluster, skill). |
| | ◆ assign student roles or responsibilities in the group. | |

Adapted from the *Nebraska K-12 Foreign Language Frameworks*

STRATEGIES FOR STUDENTS WITH SPECIFIC LEARNING NEEDS (CONTINUED)
 CONSIDERATIONS FOR MEETING SPECIFIC LEARNING NEEDS
 IN SKILL AND INSTRUCTIONAL AREAS

To ensure success *with reading* ...

- | | | |
|--|---|--|
| <ul style="list-style-type: none"> ◆ use pre-reading and post-reading activities to pre-teach or reinforce main ideas. ◆ use before, during, and after reading strategies (e.g., before—preview questions; during—pausing to reflect; after—self-evaluation, summary). ◆ provide advanced organizers when showing videos. ◆ use peer tutoring. ◆ provide audiotaped materials (text or study guides). | <ul style="list-style-type: none"> ◆ teach self-questioning. ◆ paraphrase key points and/or have students paraphrase key points. ◆ summarize key points and/or have students summarize key points. ◆ label main ideas. ◆ label 5Ws—Who? What? When? Where? Why? ◆ allow highlighting of texts, passages, key words, or concepts. ◆ use visual imagery. | <ul style="list-style-type: none"> ◆ explain idioms that appear in reading passages. ◆ allow silent pre-reading. ◆ allow partner reading. ◆ use computer programs or games. ◆ allow students to quietly read aloud (subvocalization). ◆ use graphic organizers. ◆ use preparatory set (i.e., talk through what a reading passage is about using new vocabulary and concepts). |
|--|---|--|

To ensure success *with writing* ...

- | | | |
|---|--|--|
| <ul style="list-style-type: none"> ◆ shorten writing assignments. ◆ require lists instead of sentences. ◆ dictate ideas to peers. ◆ provide note takers. ◆ allow students to use a tape recorder to dictate writing. ◆ allow visual representation of ideas. ◆ provide a fill-in-the-blank form for note taking. ◆ allow students to use a computer for outlining, wordprocessing, spelling, and grammar check. | <ul style="list-style-type: none"> ◆ provide a structure for the writing. ◆ allow collaborative writing. ◆ provide a model of the writing. ◆ allow use of different writing utensils and paper. ◆ use a flow chart for writing ideas before the student writes. ◆ brainstorm a word bank of possible words that would be needed prior to the writing activity. | <ul style="list-style-type: none"> ◆ narrow the choice of topics. ◆ grade on the basis of content; do not penalize for errors in mechanics and grammar. ◆ allow choices of manuscript, cursive, keyboarding. ◆ allow different positions of writing paper and/or surfaces. |
|---|--|--|

Adapted from the *Nebraska K-12 Foreign Language Frameworks*

STRATEGIES FOR STUDENTS WITH SPECIFIC LEARNING NEEDS (CONTINUED)
CONSIDERATIONS FOR MEETING SPECIFIC LEARNING NEEDS
IN SKILL AND INSTRUCTIONAL AREAS

To ensure success *with visually-impaired learners* ...

- ◆ describe what you are doing.
- ◆ provide preferential seating.
- ◆ provide material in large or braille print.
- ◆ give student an individual copy of visual information presented to the group.
- ◆ use black-and-white printed hand outs.
- ◆ use audiotaped books.
- ◆ use tactual materials to represent concepts—contact a vision consultant to assist with the design.
- ◆ be aware of lighting requirements.
- ◆ stand away from window glare when talking to the student.
- ◆ allow extra time to complete a task.

To ensure success *with hearing-impaired learners* ...

- ◆ provide preferential seating.
- ◆ use visual cues (overheads, drawings maps, demonstrations, visual samples of new vocabulary).
- ◆ face student directly when speaking.
- ◆ emphasize key points; don't overload with information.
- ◆ repeat or rephrase what other students say—hearing what other students say is often difficult for hearing-impaired students.
- ◆ highlight text and study guides.
- ◆ provide note-taking assistance during lectures to allow hearing-impaired student to concentrate on the teacher.
- ◆ use peer tutoring.
- ◆ use study sheets to organize information.
- ◆ pre-teach vocabulary.
- ◆ use captioned videos, films, etc.
- ◆ show videos or visuals before presenting information to provide a knowledge base for students.
- ◆ use alternative testing methods.
- ◆ minimize background noise.
- ◆ simplify vocabulary.
- ◆ use preprinted outline of materials.

To ensure success *when working in groups* ...

- ◆ use multi-modalities (visual, auditory, tactile) to teach the same concept.
- ◆ teach vocabulary in context.
- ◆ use cues, prompts.
- ◆ use graphic organizers.
- ◆ use frequent repetition of key points.
- ◆ break down instructional units into smaller steps.
- ◆ show relationships among concepts through graphs, outlines, and webbing.
- ◆ use color coding to show concepts and relationships.
- ◆ use peer tutors.
- ◆ highlight important information.
- ◆ teach mnemonics as a memory tool.
- ◆ teach visual imagery.
- ◆ use rhythm, music, and movement.
- ◆ use lists.
- ◆ use matrix to organize information; allow students to construct some of their own.
- ◆ use pictographs

Adapted from the *Nebraska K-12 Foreign Language Frameworks*

STRATEGIES FOR STUDENTS WITH SPECIFIC LEARNING NEEDS (CONTINUED)
CONSIDERATIONS FOR MEETING SPECIFIC LEARNING NEEDS
IN SKILL AND INSTRUCTIONAL AREAS

To ensure success *with understanding new concepts ...*

- | | | |
|--|---|---|
| <ul style="list-style-type: none"> ◆ pre-teach new concepts. ◆ identify priority learning from less important material. ◆ provide adequate time. ◆ provide meaningful practice, review, repetition. ◆ use flow charts. ◆ connect previous learning to new information. | <ul style="list-style-type: none"> ◆ use multiple means of learning the same material (visual, auditory, tactile). ◆ have student set personal goals. ◆ use peer tutors. | <ul style="list-style-type: none"> ◆ use multiple intelligences information to deliver material in a variety of ways. ◆ use cooperative learning and small groups. ◆ provide cues. |
|--|---|---|

Adapted from the *Nebraska K-12 Foreign Language Frameworks*

To ensure success *with attention deficit learners ...*

- ◆ surround students with peers who are good role models. Encourage peer tutoring and cooperative, collaborative learning.
- ◆ maintain eye contact with students during verbal instruction.
- ◆ make directions clear and concise. Be consistent with daily instructions.
- ◆ simplify complex directions. Avoid multiple commands.
- ◆ make sure that students comprehend before beginning the task.
- ◆ repeat in a calm, positive manner, if needed.
- ◆ help students to feel more comfortable seeking assistance. (Most ADD students won't ask for help.)
- ◆ assign only one task at a time.
- ◆ monitor frequently. Use a supportive attitude.
- ◆ modify assignments as needed. Special education personnel can identify specific strengths and weaknesses of students.
- ◆ make sure you test knowledge and not attention span.
- ◆ give extra time for certain tasks. Students with ADD may work more slowly. Don't penalize for needed extra time.
- ◆ require a daily assignment notebook if necessary. Make sure students write down all assignments each day. Parents and teachers may sign the notebook on a daily basis and use this as an additional form of communication with one another.

Adapted from the list compiled by members of CH.A.D.D. (Children with Attention Deficit Disorders) in *Meeting The Special Needs of Students*. Mission Hills, CA: Glencoe/McGraw-Hill 1997, p. 10.

Developing Intercultural Competence

Intercultural competence is a combination of knowledge, skills, and attitudes which enable individuals to communicate and interact across cultural boundaries. In the Spanish Language and Culture program, these include the skills of finding information about Spanish-speaking cultures, interpreting it in order to understand the beliefs, traditions, and cultural values of Hispanic people, relating one's own culture to cultures of Spanish-speaking peoples, and interacting with members of these cultures. In the process of developing these skills, language learners will acquire knowledge of various aspects of these cultures, a heightened awareness of their own, as well as knowledge of the processes of interaction between the two cultures. They will also work towards an attitude of increased openness, curiosity, and willingness to look at the world from the point of view of others.

Culture in this program is broadly defined as the general context and way of life, the behaviours and beliefs of a community of people whose history, geography, institutions, and commonalities are distinct and distinguish them to a greater or lesser degree from all other groups (Leblanc 44). The historical and contemporary elements of the culture from which the content is drawn may include

- historical and contemporary events
- significant individuals
- emblems or markers of national identity such as myths, cultural products, significant sites, and events in the collective memory
- public institutions
- geographical space (regions, landmarks, borders, climate)
- social distinctions
- conventions of behaviour
- beliefs, taboos, perceptions, and perspectives

Choices about which elements to include should reflect the importance of the element within the culture, and the interests and developmental level of the students.

Although cultures exert pressure on their members to conform to a variety of norms, most cultures are not homogeneous. Within each one, there are groups of people who have beliefs, values, and practices that are different from the majority or mainstream culture. These differences may be based on religion, national or ethnic origin, social class, race, or colour. A number of outcomes in this program are aimed at making students aware of the diversity within a particular culture in the Spanish-speaking world as well as differences between them and Canadian cultures.

The development of intercultural competence can take place in three contexts: in the classroom, as fieldwork, or as an independent experience. In the **classroom**, activities are planned and structured by the teacher and usually take the form of a rehearsal for interaction in real time. In the classroom, students have the opportunity for discovery and analysis of the culture along with reflection on their learning without the pressure of real time. In other words, they do not have to respond immediately. In **fieldwork**, activities are still planned and structured, but the interaction is now in real time. **Independent experiences** are those carried out by students outside of the structure of the course. This curriculum guide will deal principally with classroom activities, but with some comments on fieldwork.

Resources

Finding resources for students at a beginner level of second language learning is a challenge. Authentic documents, in other words, documents created for native speakers of Spanish and not for language learning, are useful in that they provide students with actual contact with the culture. However, finding authentic documents in which the language is appropriate for beginners can be difficult. Documents that have a high level of visual support (pictures, charts, maps, etc.) and a minimum of text are the easiest to use. Students can be taught interpretation strategies for dealing with so-called “difficult” texts. See the Sample List of Text Forms in Appendix B for ideas on the kinds of documents to look for.

Other kinds of resources are also useful for different kinds of activities. Outdated textbooks with stereotyped representations of the culture, for example, can be used to make students aware of such stereotypes. Resources can also take the form of cultural artifacts (costumes, food, music, everyday objects, crafts, etc.). These materials, which are concrete and appeal to the physical senses, are especially useful for younger students as a bridge to more abstract ideas. The greater the variety of resources, the more the students will become aware that culture is expressed through various forms, not just classical literature and fine arts.

Discovery

Students at the middle level may be very diverse in their level of cognitive and affective development. Some may be ready to handle abstract concepts such as “culture” while others are not. Some may be able to take another’s perspective, while others may be very ethnocentric in their attitudes. For this reason, initial experiences should be concrete and should involve as many of the physical senses as possible.

Interpretation

As students begin to use authentic texts, they will need to be taught skills for delving beyond the literal meaning.

Relating

“Whenever we encounter the unknown we attempt to understand it in terms which are part of our familiar world and our understanding of it. [...] Comparison therefore needs to be part of the teacher’s explicit methods...” (Byram and Zarate). By exposing students to experiences of other modes of behaviour, either in the form of real-life experiences (e.g., food) or through media (e.g., television programs), and then having them compare these experiences with their own modes of behaviour, they will begin to understand that their own way is not the only way, but just one of many ways that are influenced by culture. If students in the class are from a variety of cultural backgrounds, this understanding will be reinforced even more.

Reflection

Personal experience of elements of another culture is not, in itself, enough to counteract the tendency to reject that which is different. It is through a process of reflection and discussion following the experience that students can become aware of the process of socialization, of the natural tendency to stereotype, to reject that which is different and to see it as a threat to one’s identity. In early stages of learning, this discussion may take place in English until students have the vocabulary and structures to begin to express their feelings and thoughts in Spanish.

The experience of contact with a new cultures, reflection on that experience, and the varied responses of other students in the class who may be from different cultural backgrounds can take students one step further than just knowledge of that culture. Ideally they will come to understand the concept of culture and the phenomena (e.g., ethnocentrism, empathy, stereotyping, exoticism, discrimination, culture shock) that are characteristic of the relationship with other cultures.

Integration with Other Subjects

Intercultural competence can be developed in courses other than second language courses. Social studies and language arts are the subject areas where integration is most easily achieved. A process of collaborative planning between the Spanish teacher and the social studies or language arts teachers can be fruitful for both. In addition, students benefit from seeing the links between areas of study, transferring knowledge from one domain to another, and making connections that might otherwise have gone unnoticed.

The collaborative planning can take a variety of forms, from simply keeping each other informed of units of study that might provide opportunities for reinforcement of learning, to actually planning units together.

A Model for Spanish Language and Culture Courses at the Secondary Level

As the preceding discussion demonstrates, there are many factors and aspects of teaching and learning that must be considered in developing an effective instructional program and classroom. We can conceptualize this as being the interplay of six factors: learner, teacher, course content, learning environment, pedagogy, and assessment.

A MODEL FOR EFFECTIVE TEACHING AND LEARNING
(SECONDARY LEVEL)



Adapted from *New Jersey World Languages Curriculum Framework*, Winter 1999

Teaching and Learning in the Spanish Classroom

Instructional Strategies

Effective teachers know they are teaching students as well as content. They also know that, in every class, there will be a diversity of students, each of whom will bring to the activity environment different perceptions, prior knowledge, attitudes, and learning styles. It is the teacher's responsibility to make use of a variety of instructional approaches to ensure that all types of students and their various needs are being met.

Decision-making regarding instructional strategies requires teachers to focus on curriculum, the prior experiences and knowledge of students, learner interests, student learning styles, and the developmental levels of the learner. Such decision-making relies on ongoing student assessment that is linked to learning objectives and processes.

The following diagram shows the five instructional strategies that are most effective in developing communicative competence in second language classrooms. They have been grouped according to the categories outlined in *Instructional Approaches: A Framework for Professional Practice* (Saskatchewan Education, available online at <<http://www.sasked.gov.sk.ca/docs/policy/approach/index.html>>). A more detailed description of some of these strategies follows.

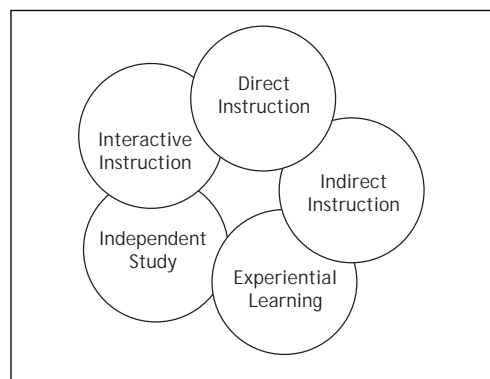

Figure 3. Instructional Strategies

Direct Instruction

Direct instruction is highly teacher-directed and is historically one of the strategies most commonly used. It is used for providing information or developing step-by-step skills. This strategy works well for introducing other teaching methods or actively involving students in knowledge construction.

Direct instruction is usually deductive; that is, the rule or generalization is presented and then illustrated with examples. While this strategy may be considered easy to use, effective direct instruction is often more complex than it would first appear.

Indirect Instruction

Indirect instruction is mainly student-centered and seeks a high level of student involvement in observing, investigating, drawing inferences from data, or forming hypotheses. It takes advantage of students' interest and curiosity, often encouraging them to generate alternatives or solve problems. It is flexible, in that it frees students to explore diverse possibilities and reduces the fear associated with the possibility of giving incorrect answers. Indirect instruction also fosters creativity and the development of interpersonal skills and abilities.

Interactive Instruction

Interactive instruction relies heavily on discussion and sharing among participants. Discussion and sharing provide learners with opportunities to "react to the ideas, experience, insights, and knowledge of the teacher or of peer learners and to generate alternative ways of thinking and feeling" (Seaman and Fellenz 119). Students can learn from peers and teachers to develop social skills and abilities, to organize their thoughts, and to develop rational arguments. The interactive instruction strategy allows for a range of groupings and interactive methods.

Experiential Learning

Experiential learning is inductive, learner-centred, and activity-oriented. Personalized reflection about an experience and the formulation of plans to apply learning to other contexts are critical factors in effective experiential learning. The emphasis in experiential learning is on the process of learning, and not on the product. Experiential learning occurs when learners

- participate in an activity and critically look back on the activity to clarify learning and feelings
- draw useful insights from such analysis and put learning to work in new situations

Independent Study

Independent study refers to the range of instructional methods which are purposefully provided to foster the development of individual student initiative, self-reliance, and self-improvement. While independent study may be initiated by student or teacher, the focus here will be on planned independent study by students under the guidance or supervision of a classroom teacher.

In addition, independent study can include learning in partnership with another individual or as part of a small group. Independent study encourages students to take responsibility for planning and pacing their own learning.

After deciding on appropriate instructional strategies, a teacher must make decisions regarding instructional methods. As is the case with strategies, the distinctions between methods are not always clear-cut, although they are categorized for the purpose of this document. The following checklist illustrates how various methods relate to the five broad categories of strategies. It should be noted that the methods appearing in the checklist are examples only, and are not intended to be inclusive of all instructional methods.

Instructional Methods Checklist

Direct Instruction

- Compare and Contrast
- Demonstration
- Didactic Questions
- Drill and Practice
- Guides for Listening, Reading, and Viewing
- Mini-lecture
- Password/Language Ladders
- Read and Retell
- Structural Exercises

Indirect Instruction

- Author's Chair
- Case Studies
- Cloze Procedure
- Graphic Organizers
- Discussions
- Grammatical Problem Solving
- Reflective Discussions

Interactive Instruction

- Brainstorming
- Categorizing
- Circle of Knowledge
- Cooperative Learning
- Cultural Presentations
- Information Gap
- Interactive Language Tasks
- Language Experience
- Learning Cycle
- Surveys and Interviews
- Debate
- Problem Solving

Experiential Learning

- Field Trips
- Focused Imaging
- Games
- Role Play

Independent Study

- Computer-Assisted Instruction
- Logs and Journals
- Free Writing
- Personal Dictionaries
- Learning Contracts
- Research Projects

Direct Instruction Methods

Direct instruction methods are highly teacher-centered. They are often used in the following situations:

- daily, weekly, and monthly review
- presenting new material
- conducting guided practice
- providing feedback and correctives

Compare and Contrast

This method involves looking for similarities and differences, for example, between an aspect of a Spanish-speaking culture and the students' own culture.

Students

- observe details and develop criteria
- identify similarities
- search and sort out differences based on criteria
- summarize

The four components of compare and contrast, as listed above, can be used in assessment as criteria in the templates for anecdotal records, checklists, and rating scales.

Demonstration

This method refers to teacher activities and talk that show students how. Demonstrations apply primarily to skills and processes, and are useful for helping students acquire procedural knowledge. Teachers might, for example, take students step by step through the writing process, or demonstrate a particular learning strategy.

Didactic Questions

These are questions that tend to be convergent (they tend to focus on one topic) and factual. They often begin with "*qué*," "*dónde*," "*cuándo*," "*adónde*," or "*cómo*."

The teacher is able to observe the degree of student acquisition of knowledge of content and process through this activity. A written assignment or an oral presentation or interview (live or taped) may be the ongoing student activity used for assessment. The teacher will record student progress using a rating scale, checklist, or anecdotal records.

Drill and Practice

This method refers to the structured, repetitive review of previously learned concepts to a predetermined level of mastery. It tends to focus on skills. Care should be taken to ensure that these exercises are directly related to the context in which the student will use the language being practised and that they require the student to focus on the meaning as well as on the form. To assess the level of skill, teachers will need to use performance assessments or performance tests. Teachers need to establish criteria indicating what students are to do. The criteria are inserted into the templates for anecdotal records, rating scales, and checklists.

Guides for Listening, Reading, and Viewing

Students' comprehension of a selection is guided and developed by teacher-prepared questions or graphic organizers. As students gain practice and confidence in using this method, the teacher will monitor or confer with small groups or individuals.

Mini-lecture

The mini-lecture is a one-way type of communication. It is an efficient way of providing a small amount of information in a short period of time. The purpose of a mini-lecture is to impart knowledge about an aspect of culture, for example, or a grammatical structure.

Mini-lectures are effective when they are

- 10–15 minutes in duration, and never longer than 20 minutes
- mixed with group discussion and demonstrations
- accomplished with such visual aids as overhead transparencies and posters.

The most appropriate way of assessing understanding is a combination of test items such as essay, short-answer, multiple-choice, and true/false.

Password/Language Ladders

This is a method in which students learn to speak sentences or phrases ("passwords") that are associated with desired activities.

The teacher introduces a series of phrases in Spanish that the students must speak in order to do a desired activity, such as "*¿Puedo ir al baño?*" "*¿Puedo sacarle punta a mi lápiz?*" "*¿Puede ayudarme?*" The students learn new passwords of increasing complexity in subsequent classes.

Password/language ladders are effective when they

- engage students' active participation
- give an authentic experience of using Spanish
- develop oral comprehension as a continuum within authentic situations

Read and Retell

This all-purpose method involves students retelling a passage in Spanish as they remember it.

The teacher asks the students to read a passage. Students can be working together as a class, in small groups, in pairs, or working alone with the teacher. Then, the teacher asks the students to retell the passage as they remember it, either orally or in writing using Spanish.

Read and retell is effective when it

- provides practice in a range of literacy skills in the target language including listening, speaking, reading, writing, interacting, comparing, matching, selecting, remembering, comprehending, and organizing the information
- provides an index of growth and development in a wide range of literacy learning
- provides opportunities to use the target language

Structural Exercises

Definition

Structural exercises are exercises that focus the attention of the students on the form or structure of the language. Research has shown that students learn better from these kinds of exercises if there is a direct connection with their own productions. Structural exercises can take a variety of forms depending on the structures and vocabulary that need to be practiced. Some examples are

- adding words or phrases to a short sentence
- taking words or phrases out of a long sentence
- substituting words or phrases for other ones in a sentence
- moving words or phrases around in a sentence
- changing elements of a sentence.

Procedure

The basic procedure is similar for all types of exercises.

1. Begin with sentences taken from texts written by the students. Choose structures that are giving problems to a number of students.
2. Write the sentences on strips of paper and cut them up. When doing this for the first time with students, write on large strips so that the whole class can see what you are doing. Later, when students are able to do these exercises on their own or in small groups, the sentences can be written on smaller strips of paper. Have some blank strips of paper ready for new words.

3. Ask students for suggestions depending on the type of exercise you have chosen (add, take away, substitute, move, change, etc.). Analyze the new sentence that is formed, by asking questions such as, "Does this new sentence make sense?", "How has the meaning changed?", "Do we have to make any other changes so that the sentence is still grammatically correct?"
4. Repeat these steps a number of times as a whole group, then have students do more individually or in small groups.
5. Students should have opportunities to use the same structures and vocabulary in their own speech or writing as soon as possible after doing the exercises.

Tips

The analysis and discussion that follow each change in the sentence is particularly important to make students aware of changes in the meaning. Exercises where students make changes to sentences without having to reflect on the meaning are not effective in teaching and reinforcing structures.

In some cases structural exercises can be based on or can be transformed into songs or cumulative stories (stories in which a part of the story is repeated with a new element added on each time).

Applications

1. Add a word or phrase. Use this exercise to encourage students to expand their vocabulary, to provide more detail and to use more complex sentence structures. An example follows:

Aquí está mi casa.

Aquí está mi casa pequeña.

Aquí está mi casa pequeña y blanca.

Aquí está mi casa pequeña y blanca de ladrillo.

2. Take away a word or phrase. This exercise helps students understand which elements are necessary for the syntax of the sentence. An example follows:

Las/os niñitos aprenden poemas infantiles de su madre.

Las/os niños aprenden poemas infantiles de su madre.

Los niños aprenden poemas infantiles de su madre.

Los niños aprenden rimas de su madre.

Los niños aprenden rimas.

3. Substitute one word or phrase for another in the sentence. This form of exercise helps students understand which elements in the sentence perform the same function. The following exercise focuses attention on the possessive pronouns as per the following chart.

Singular	Plural	Singular	Plural
<i>el mío la mía</i>	<i>los míos las mías</i>	<i>el nuestro la nuestra</i>	<i>los nuestros las nuestras</i>
<i>el tuyo la tuya</i>	<i>los tuyos las tuyas</i>	<i>el vuestro la vuestra</i>	<i>los vuestros las vuestras</i>
<i>el suyo la suya</i>	<i>los suyos las suyas</i>	<i>el suyo la suya</i>	<i>los suyos las suyas</i>

Este es tu coche/carro.

Este es el tuyo.

Este es nuestro coche/carro.

Este es el nuestro.

Aquí está la tarea.

Aquí está la mía.

Aquí están sus deberes.

Aquí están los suyos.

4. Move a word or phrase to another place in the sentence. Moving elements around in the sentence encourages students to use a variety of different sentence structures and to recognize the limits imposed by normal word order. It also sensitizes students to subtle changes in meaning communicated by changes in word order. An example follows:

Rápidamente cruzó la calle corriendo.

Ella cruzó la calle rápidamente corriendo.

Ella cruzó la calle corriendo rápidamente.

Students may find another way of changing the sentence.

5. Change an element of the sentence. Once again, this type of exercise encourages students to vary their sentence structure and to practise different sentence types. Examples follow:

Me gustan los perros calientes. → No me gustan los perritos calientes.

Use the same words to present different ways to structure language:

noun — pronoun

statement to question

Isabel va a la escuela. → ¿Va Isabel a la escuela?

Language Development

Specific exercises can be devised to work on the most common errors that students make. For example, take sentences from the rough drafts of student writings, do appropriate structural exercises, and then have students correct their own productions. The repetition involved in doing the exercises helps to make common structures automatic for second language students.

Indirect Instruction Methods

Indirect instructional methods are student-centered. These methods are very effective when the instructional goals include

- thinking outcomes
- attitudes, values, or interpersonal outcomes
- process as well as product
- personalized understanding and long-term retention of concepts or generalizations
- lifelong learning capability

Author's Chair

During this procedure, students read aloud their written drafts or compositions to others. Listeners provide positive comments and constructive feedback to the "author" to assist future writing efforts. Writing is usually shared with the entire class, but occasionally authors could read to small groups. One particular chair or area of the classroom may be designated for this activity.

Case Studies

Case studies are usually descriptions of real or imaginary situations that are either unresolved or have a controversial theme. They are used for group discussion and for the generation of ideas and solutions. Case studies are a useful strategy for looking at misunderstandings between people of different cultural groups. They can be used as individual assignments or as small group assignments. Discussion of what has been learned is a valuable follow-up to a case study approach.

Cloze Procedure

The Cloze Procedure is an open-ended method in which a selected word or phrase is eliminated from a written or oral sentence or paragraph.

The teacher eliminates a word or phrase from the sentence. Students complete the sentence with a word that “makes sense.” The teacher may select random words or a specific part of speech. This can be expanded to the more difficult task of finding a word that makes sense when only the initial letter of the word is provided.

Cloze is effective when it

- provides opportunities for creativity
- develops the use of precise vocabulary
- focuses on the use of precise and correct communication
- increases comprehension skills
- provides opportunities to use Spanish

Procedure

The cloze procedure is most often used with written texts and is particularly effective if done with groups of students rather than individually.

1. Choose a written text (or write a text) appropriate to the students' level. Leave the first sentence untouched, then delete a number of words from the rest of the text, leaving the last sentence untouched as well. There are a number of ways of deciding which words to delete:
 - delete every seventh word (fewer for beginner level students, more for more advanced students)
 - delete key words related to the topic of the sentence
 - delete words that have a particular grammatical function (such as all the adjectives, or all the pronouns).

Replace the words with blanks of equal length so that there is no clue as to the length of the words that have been deleted.

2. Ask the students to read the text and try to fill in the missing words. They can use any clues they can find in the text, or any knowledge they have of the topic or the language to try to discover what the missing words might be. The text must make sense when it is complete.
3. Ask the students to explain why they think a particular word fits the blank in the sentence. If there is more than one suggestion, the students can discuss their reasons for each choice and decide which is the best. The sharing of ideas and interpretation strategies is an important aspect of this instructional method.

Tips

If the students have never done this kind of exercise before, do several together with the whole class before having them work independently in small groups. Model the process of looking for clues in the text by “thinking aloud” as you go through the text with the students.

The object of the activity is not necessarily to find the original word. If the students are able to fill the blank with a word that makes sense and fits the sentence grammatically, it does not need to be the word originally in the text.

Make a list of the strategies used to fill in the missing words and post it in the classroom. Add to the list as new strategies are introduced.

Applications

The cloze procedure can be used on the opening paragraphs of a longer text that the students will be reading to help them focus on key words for the reading and to encourage them to use their background knowledge of the topic to improve comprehension.

This procedure can also be used orally to encourage students to predict what is to come. While reading aloud, stop and have students listen carefully to predict the next word or phrase in the sentence.

The cloze procedure can also be employed to assess the students’ use of a variety of interpretation strategies and their awareness of particular language patterns and structures.

Language Development

The cloze technique helps students become aware of interpretation strategies they are using and learn new strategies by listening to the explanations of their fellow classmates. It helps them learn to use the context and their prior knowledge to make intelligent guesses about unknown words they may encounter in their reading.

Graphic Organizers

Definition

Graphic organizers are visual representations of texts or groups of related ideas, words or thoughts. They can take a variety of forms, some of which have a specific name, depending on what they are representing and how they will be used. Some examples are frames, mind maps, webs, concept or semantic maps, story maps, Venn diagrams, and flow charts.

The teacher provides a specific format for learning, recalling, and organizing linguistic or cultural concepts learned through Spanish.

Graphic organizers are beneficial when they are used to

- help students visualize abstract concepts
- help learners organize ideas
- provide a visual format for study

Consequence Diagram/Decision Trees—A graphic organizer method in which students use diagrams or decision trees to illustrate real or possible outcomes of different target cultural actions or situations.

Students visually depict outcomes for a given problem by charting various decisions and their possible consequences.

Consequence diagrams/decision trees are effective tools to

- help in transferring Spanish-language learning to application
- aid in predicting with accuracy
- develop the ability to identify the causes and effects of decisions
- aid in clarifying positive and negative statements

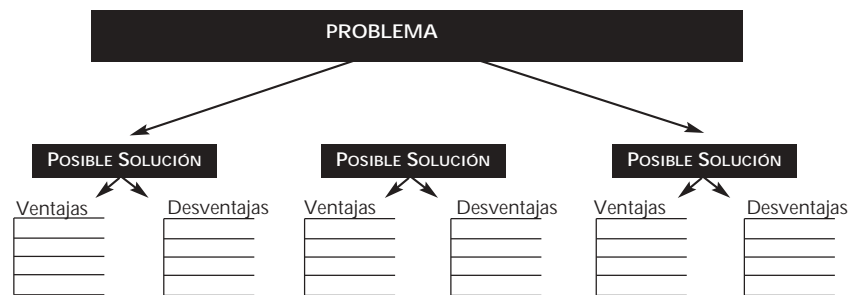

Concept Mapping—A graphic organizer method that shows the relationships among concepts. Usually the concepts are circled and the relationships are shown by connecting lines with short explanations in Spanish or graphical depictions of the objects or concepts.

The teacher selects a main idea. Using Spanish, the teacher and students then identify a set of concepts associated with a main idea. Concepts are ranked in related groups from most general to most specific. Related concepts are connected and the links labeled with words, pictures, or short phrases.

Concept mapping is an effective tool to

- help students visualize how ideas are connected, and understand linguistic relationships and how knowledge is organized
- improve oral communication, comprehension, and problem-solving skills

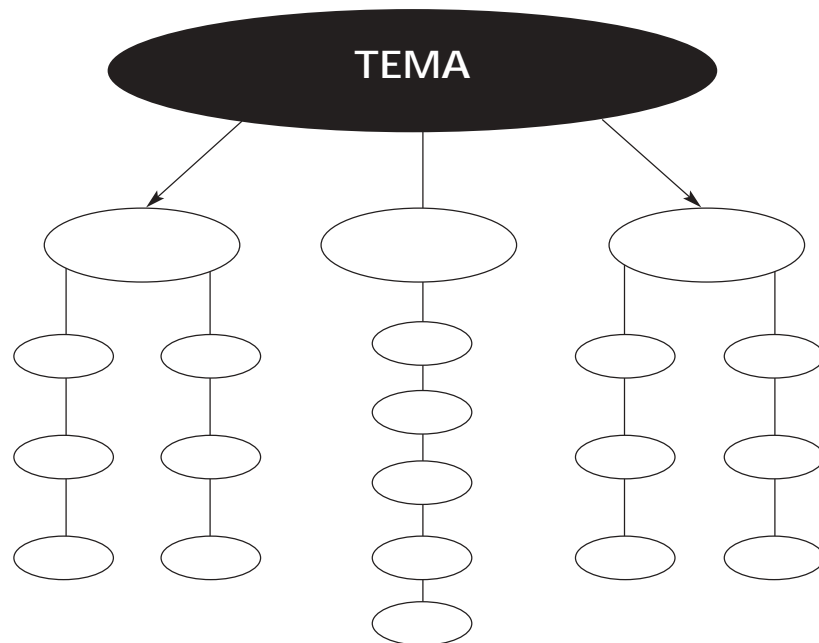

K-W-L (Know-Want to Know-Learned)—An introductory method that provides a structure for recalling what students know regarding a target language or cultural topic, noting what students want to know, and finally listing what has been learned and is yet to be learned.

Before engaging in an activity, reading a chapter, listening to a lecture, or watching a film or presentation, the teacher lists on the board under the heading **What We Know** all the information students know or think they know about a topic. Then, the teacher lists all the information the students want to know about a topic under **What We Want to Know**.

While engaging in the planned activity, the students research and read about the topic, keeping in mind the information they had listed under **What We Want to Know**.

After completing the activity, the students confirm the accuracy of what was listed and identify what they learned, contrasting it with what they wanted to know. The teacher lists what the students learned under **What We Learned**.

K-W-L strategies are effective tools to

- build on prior knowledge
- develop predicting skills
- provide a structure for learning
- develop research skills
- develop communication skills in cooperative groups
- strengthen teamwork skills
- provide opportunities to use Spanish reading, writing, listening, speaking, and viewing

S	Q	A
<i>Lo</i>	<i>Lo que</i>	<i>Lo</i>
<i>que</i>	<i>queremos</i>	<i>que</i>
<i>sabemos</i>	<i>saber</i>	<i>aprendimos</i>

Learning Log—A method to develop structured writing in Spanish. An excellent follow-up to K-W-L.

During different stages of the language learning process, students respond in written form under three columns:

What I Think/Lo que pienso

What I Learned/Lo que aprendí

**How My Thinking Has Changed/
Cómo ha cambiado mi opinión**

Learning logs are effective tools to

- bridge the gap between prior knowledge and new content
- provide a structure for translating target language concepts into written form.

Webbing—A graphic organizer method that provides a visual picture of how target language words or phrases connect to a content-based or cultural topic.

The teacher lists a topic and builds a web-like structure of target language words or phrases that students call out as being connected to a topic. Students can also use this method individually in planning, writing, or in studying for a test.

Webbing is an effective tool to

- provide opportunities for the visual learner to “recall” the connections for later use
- help students use and share their prior linguistic knowledge
- help students identify patterns of information

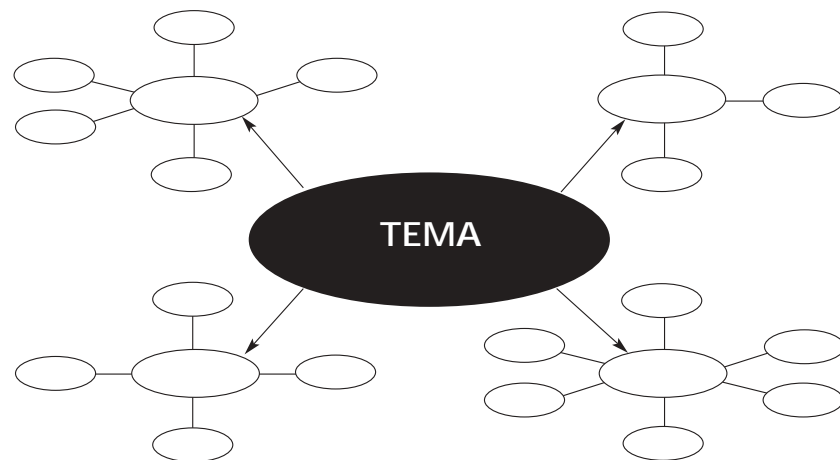

Venn Diagram—A graphic organizer method, derived from mathematics, for creating a visual analysis of information representing the similarities and differences among, for example, Spanish language concepts or Spanish culture objects, events, animals, and people.

Using two overlapping circles, students list unique characteristics of two items or concepts (one in the left part of circle and one in the right); in the middle they list shared characteristics. More than two circles can be used for a more complex process.

Venn Diagrams are effective tools to

- help students organize ideas, and Spanish language and culture concepts
- help students develop a plan for writing
- allow students to focus on the similarities and differences within and among languages and cultures
- develop the ability to draw conclusions and synthesize
- stimulate higher cognitive thinking skills

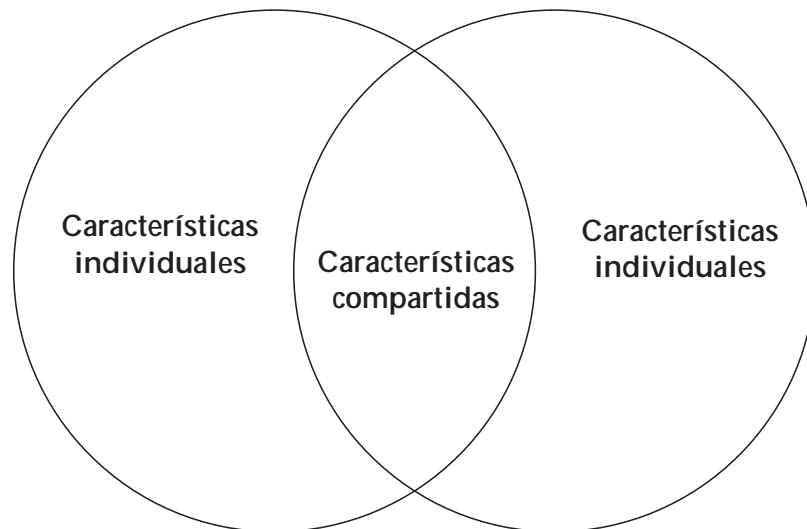

Flowchart—A graphic organizer method used to depict a sequence of events, actions, roles, or decisions.

Students structure a sequential flow of events, actions, roles, or decisions graphically on paper.

Flowcharts are effective tools to

- foster logical and sequential thinking
- focus on cultural connections
- develop the ability to identify details and specific points
- develop organizational skills
- aid in planning
- provide an outline for writing in the target language

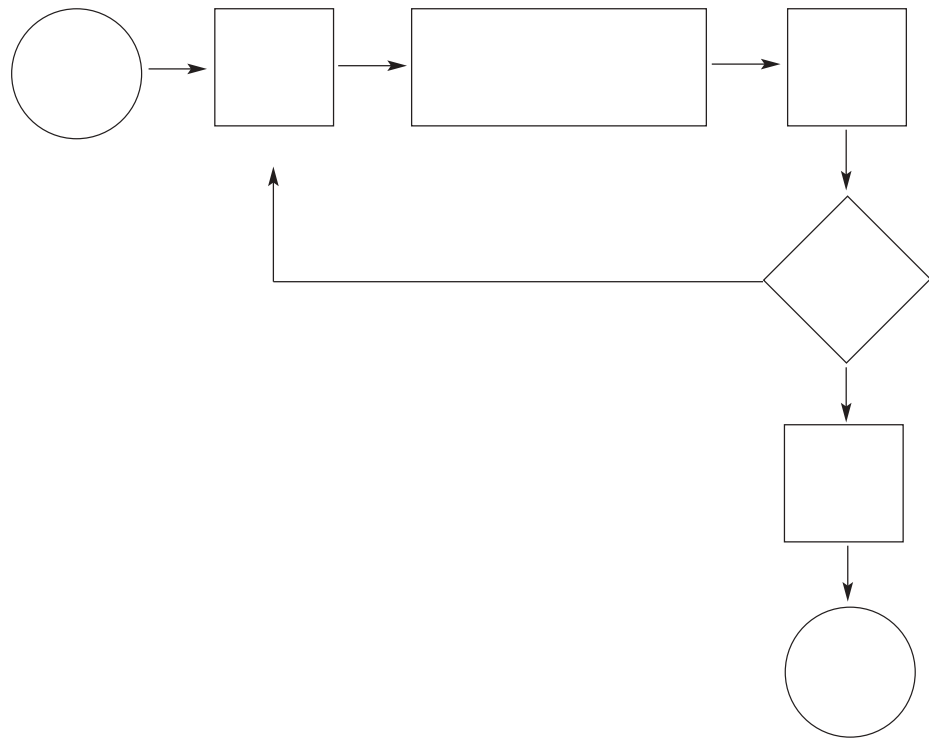

*T-Chart**

Purpose: To clarify central concepts or ideas; to collect specific examples for an idea or behavior.

Thinking Skills: Specifying, categorizing

How to use: In the **Looks Like** column, list all the behaviors or observable characteristics related to a topic; in the **Sounds Like** column, list all the sounds or audible characteristics, including possible verbal messages.

*As described and illustrated in Bellanca

ACUERDO	
<p><i>Looks Like / Se ve como</i></p> <p>nodding head / <i>asentir con la cabeza</i> eye contact / <i>contacto visual</i> smile / <i>sonrisa</i> attention / <i>atención</i></p>	<p><i>Sounds Like / Parece como</i></p> <p>"I can live with it." / <i>"Puedo vivir con ello."</i> "Good idea." / <i>"Buena idea."</i> "That will help us." / <i>"Eso nos ayudará."</i> "I see your point." / <i>"Te entiendo."</i></p>

Name(s) / Nombre(s) _____ Topic / Tema _____	
T-CHART / CUADRO T	
Title / Título _____	
<i>Looks Like / Se ve como</i>	<i>Sounds Like / Parece como</i>

Procedure

When introducing graphic organizers for the first time, model their use in a simple situation, going step by step through the process, explaining what you are doing at each step and why. Use the same graphic organizer on several occasions, getting more and more student input each time. As students gain more understanding and skill, they can be given more opportunity for discussion about how different elements should be represented and what they should be linked to. Once students are accustomed to using a particular type of graphic organizer, they can begin to use it independently in small groups. The form of familiar graphic organizers can be posted in the classroom as a resource for students as they work.

Second language learners may need some preparation before working on a graphic organizer to build their vocabulary on the topic. They might watch a short film, read a text (or listen to someone else read), or brainstorm ideas and categorize them. Throughout the preparatory activity and the development of the graphic organizer, the teacher can supply any vocabulary that the students are lacking.

Tips

For beginners or younger students, pictures can be used instead of, or in addition to, words.

Use different colours and shapes to add more meaning to the graphic organizer. For example, use wool or string of different colours to show links between words or ideas.

Prepare labels of the words associated with a theme or topic and have students organize them, showing the connections they think are important. When they are happy with their arrangement, they can glue the labels on a large sheet of paper or attach them to a bulletin board with tacks or staples.

Applications

People construct knowledge based on what they already know. Graphic organizers are used to organize and represent knowledge, and help the learner construct new meanings in a subject. The goal of this method is not to find the "right answer" or the "correct" graphic organizer. It is to improve understanding of texts or to explore how ideas or words relate to each other.

Understanding can be expanded by discussing different visual representations and seeing how others' interpretation is different from one's own.

The following is a partial **concept map** based on weather which could be used to summarize vocabulary introduced in a unit on that topic or to prepare for a listening activity using weather reports.

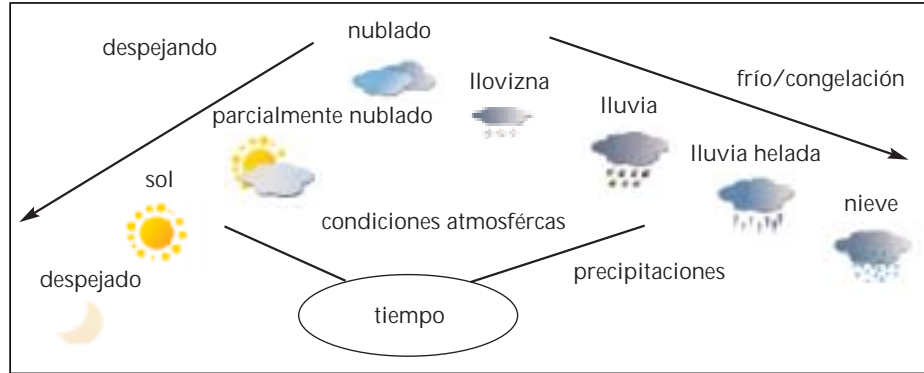

The following graphic organizer is a story map that shows the principal elements that are present in most fiction. Story maps can be used to help students understand the structure of a story, to see common patterns from one story to another, to assess their understanding of a specific story, to make predictions before beginning to read or listen to a story, or as a planning tool when preparing to write a story.

¿Quién? (¿Quiénes son los personajes?) _____

¿Cuándo? (¿Cuándo ocurre la historia?) _____

¿Dónde? (el escenario) _____

Al comienzo/principio (¿Cuál es la situación?)

La parte principal (¿Cuáles son los acontecimientos?)

El fin/la conclusión (¿Cómo termina el cuento/la novela/la historia?)

Different kinds of graphic organizers can be used to represent expository texts. The most common structures for these kinds of texts are

- description
- enumeration or listing
- comparison and contrast
- cause and effect
- problem and solution

At the same time as students are made aware of how these different kinds of texts are organized, they can learn the key words and phrases used to structure the texts. A **Venn diagram** is an example of a graphic organizer for comparison and contrast. Differences are recorded in the outer parts of the circles, similarities in the area where they overlap.

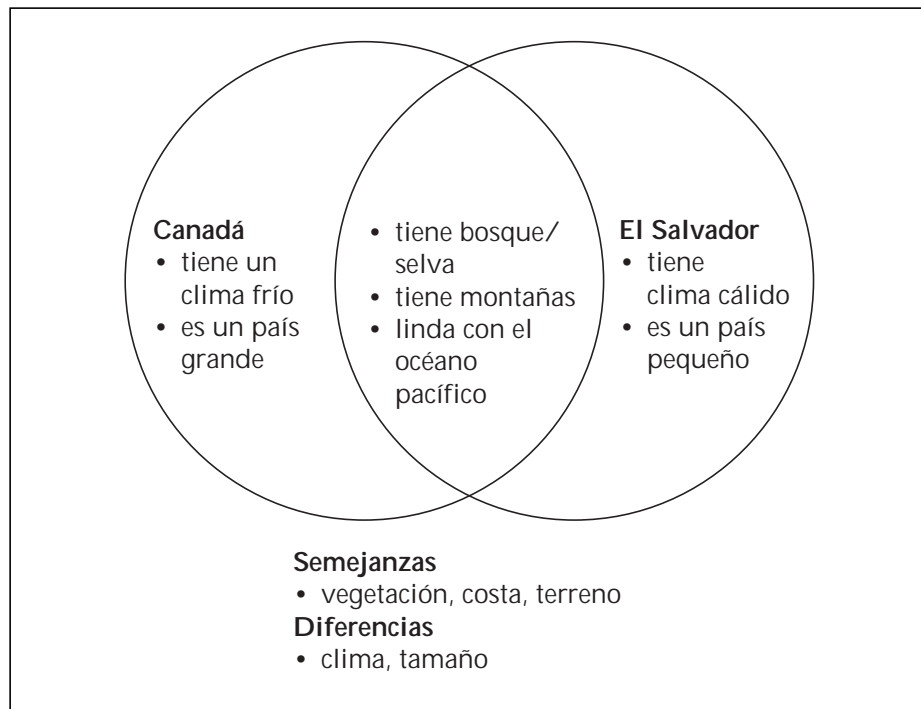

Language Development

Graphic organizers are used for a wide variety of purposes in the second language classroom. They can help students

- organize information they have heard, viewed, or read
- remember vocabulary by making connections with words or phrases they already know
- plan an oral or a written text
- better understand the way texts of different types are structured and organized
- prepare for a listening, reading, or viewing activity by anticipating what they might hear or see
- learn new concepts by relating them to what they already know
- represent what they know about a topic.

Discussions

A discussion is an oral exploration of a topic, object, concept, or experience. All learners need frequent opportunities to generate and share their questions and ideas in small and whole class settings. Teachers who encourage and accept students' questions and comments without judgement and clarify understandings by paraphrasing difficult terms motivate students' interest in using the Spanish language and the exchange of ideas.

The teacher or student initiates the discussion by asking a question that requires students to reflect upon and interpret films, experiences, read or recorded stories, or illustrations. As students question and recreate information and events in a film or story, they clarify their thoughts and feelings. The questions posed should encourage students to relate text content to life experiences and to other text. Interpretations will vary, but such variances demonstrate that differences of opinion are valuable.

Grammatical Problem Solving

Definition

A method often used to teach grammar is to present students with a rule, provide them with examples, and then have them do exercises to determine if they understand the rule and to help them learn through repetitive drill. Grammatical problem solving involves having students use deductive reasoning to discover rules and understand grammatical concepts on their own. Instead of working from the rule to the examples, students work from the examples to the rule.

Procedure

1. Provide students with a number of examples that illustrate a particular grammar rule that you want them to learn. Ask them to look at the examples and try to determine what the rule might be. It is useful for students to work in pairs or small groups, and discuss their reasoning.
2. If their first attempt at deducing the rule is not successful, provide more examples that are designed to lead them in the right direction. It is also helpful to provide contrasting examples to guide the thinking of students. Continue in this way until they have discovered what the rule is.
3. Once students have figured out the rule, ask them to provide their own examples to check for understanding.

Tips

It is not important that students use the proper grammatical terminology as long as they are able to explain what they mean. Often if students formulate the rule in their own words, they will be able to remember it better.

Start with a fairly simple rule if students are not used to this method. It may take some practice for them to be able to formulate rules of their own.

Applications

This method can be used to teach almost any language rule. Here are some examples:

1. Pronunciation (hard sound versus soft)

<u>c</u> ien	casa	gana	gira
	cuenta	guante	general
<u>c</u> irco	cola	gol	

2. Grammar (singular/plural)

el <u>libro</u>	los <u>libros</u>
la <u>casa</u>	las <u>casas</u>

3. Spelling

inte <u>l</u> igente	inte <u>ll</u> igent
artista <u>a</u>	artist
acc <u>í</u> ón	act <u>i</u> on

4. Verb Tenses

Ayer estudié	mañana estudiaré
hablé	
miré	

Language Development

Having students discover or deduce the rule themselves usually leads to a better understanding of the grammatical rule or concept. It also develops their ability to learn language independently. Being able to deduce rules from multiple examples is an effective language learning strategy.

Reflective Discussions

Reflective discussions encourage students to think and talk about what they have observed, heard, or read.

Reflective Thinking—A method in which students reflect on what was learned after a lesson is finished, either orally or in written form.

Two possible approaches to reflective thinking are (1) students can write in a journal in their own words: the concept learned, comments on the learning process, questions, and interest in further exploration; (2) students can answer an oral questionnaire addressing such questions as “Why did you study this? Can you relate it to real life?”

Reflective thinking strategy is an effective tool to

- help students assimilate what they have learned
- help students connect concepts to make ideas more meaningful
- foster additional opportunities to use the target language in a meaningful setting

Interactive Instruction Methods

Interactive instruction methods employ groups of learners. Before the group members get to work, it is important for them to be aware of what they are to accomplish, how much time they have, and what the recording or reporting procedures are.

Brainstorming

Brainstorming is a strategy for eliciting ideas from a group and communicating them in Spanish in oral or written form.

Students contribute ideas related to a topic. All contributions are accepted without initial comment. After the list of ideas is finalized, students categorize, prioritize, and defend selections.

Brainstorming is an effective tool to

- reveal background information and knowledge of a topic
- disclose misconceptions
- help students relate existing knowledge to content
- strengthen Spanish communication skills
- stimulate creative thinking

Brainstorming is a technique for producing the greatest possible number of ideas around a question or a topic. Originally developed to stimulate creativity, this technique is now commonly used in classrooms to encourage students to explore what they know or want to know about a topic.

Brainstorming is most effective when

- all statements are accepted
- quantity rather than quality is emphasized
- no criticism is given, anything goes (no matter how outrageous or far-fetched)
- no discussion or judgments except for clarification purposes
- people can build on other ideas
- a fixed time is allocated
- once ideas have been generated, they can be combined or ordered

Teachers may decide to assess brainstorming when it is used in the context of cooperative learning groups. Anecdotal records may be the preferred method of recording data.

Brainstorming is particularly useful in the following situations:

- to explore possible solutions to a problem
- to get ideas for a writing project
- to explore what students know about a topic
- to explore questions or topics for further research

This technique may not seem well suited to the second language classroom at first, since students will sometimes have difficulty expressing their ideas in the second language. It is, however, very useful for developing vocabulary and structures at the beginning of a unit. Here are a few ideas to make it more successful in second language classrooms:

- Before using brainstorming on a topic that is unfamiliar to students, have them read a text, view a film, or do an activity that will introduce them to some of the vocabulary and expressions they will need.
- Encourage students to use gestures, illustrations, and paraphrasing if they cannot think of the exact word they need.
- If students use English to express their idea, give them the equivalent word or expression in the second language and write it down with the other ideas, adding a drawing or brief explanation so that they can remember what it means.
- If you can't think of the word, do not be afraid to admit it and use a dictionary to find the correct term or spelling.

Categorizing

Categorizing involves grouping objects or ideas according to criteria that describe common features or the relationships among all members of that group.

This procedure enables students to see patterns and connections; it develops students' abilities to manage or organize information. Categorizing is often used to organize the information produced during a brainstorming activity.

Assessment might include monitoring students' ability to understand relationships among items, categorize items using more than one criteria or category, and categorize items independently.

Circle of Knowledge

This method involves each student in thinking and discussing a topic with peers before sharing ideas with a large group. Students take turns going around the circle. The circle of knowledge method is used in the same manner as reflective discussion.

Cooperative Learning

Cooperative learning is a method in which students work together in small groups to achieve a common goal, while communicating in Spanish. Cooperative learning involves more than simply putting students into work or study groups. Teachers promote individual responsibility and positive group interdependence by making sure that each group member is responsible for a given task. Cooperative learning can be enhanced when group members have diverse abilities and backgrounds.

After organizing students into groups, the teacher thoroughly explains a task to be accomplished within a time frame. The teacher facilitates the selection of individual roles within the group and monitors the groups, intervening only when necessary, to support students working together successfully and accomplishing the task.

Cooperative learning is an effective tool to

- foster interdependence and pursuit of mutual goals and rewards
- develop leadership skills
- increase the opportunities to use Spanish in authentic, communicative situations
- increase participation of shyer students
- produce higher levels of student achievement, thus increasing self-esteem
- foster respect for diverse abilities and perspectives

Cooperative learning embraces a number of interactive instruction methods that involve students working in small groups to complete a task or project. The task is structured in such a way that involvement of each group member contributes to completion of the task. Success is based on the performance of the group rather than on the performance of individual group members.

Cooperative learning stresses interdependence and promotes cooperation rather than competition. Establishing and maintaining cooperative group norms develops the concept of a community of learners. Cooperative learning activities are carefully structured to include five basic elements:

Positive Interdependence: Each member of the group is concerned about the performance of other group members as well as their own. All individuals must succeed for the group to succeed.

Individual Accountability: Each member of the group is responsible for the work of the group.

Face-to-face Interaction: Students work in environments that facilitate communication and cooperation.

Social Skills: Students are directly taught the human interaction skills that enable groups to function effectively.

Group Processing: Group members have opportunities to receive feedback on how their group has been functioning and make plans to improve.

Cooperative learning activities can be structured in many ways (see applications below), but these five elements should be present in some form or other.

Procedure

1. **Positive interdependence** can be structured into group activities in a number of ways:

- Students have a common goal (e.g., every member must contribute to making a single product or all members of the group must improve their score on a quiz).
- Students receive the same reward for completing the task (e.g., their group project is displayed in the school or each group member receives bonus points to add to their individual score).
- Students share one set of materials or information (e.g., the group gets one large sheet of paper, one set of coloured pencils, one ruler, and one eraser to produce a map).
- Each member of the group is assigned a complementary and interconnected role (e.g., in a group of two, one person cuts and the other glues; or in a group of four, students share the roles of reader, writer, timekeeper, and noise monitor). Direct teaching of different roles within the group may be necessary. Rotate the roles so that all students have the opportunity to develop their skills in different roles.
- Each member of the group is responsible for carrying out one step of an overall task that needs to be done in step-by-step order (e.g., when preparing a dish, one group member is responsible for gathering ingredients, another for measuring, another for mixing; or when producing the final copy of a letter, one student checks the spelling, another checks the grammar, another checks the page layout, and another checks for capitalization and punctuation).
- Students work together against an outside force or constraint (e.g., team members try to beat their previous team score on a quiz or they try to find the most words related to food in a set period of time).
- Members of the group choose a group name, motto, logo, flag, song, or chant to help establish a feeling of identification with the group.

2. **Individual accountability** is created when any member of the group may be called upon to present the work of the group, defend a decision taken by the group, or answer questions about the project the group has been working on.
3. **Face-to-face interaction** is facilitated when the conditions of work allow the students to work together easily. They can, for example, be grouped around a small table if they need a work surface, or on chairs in a circle if they are just talking. Sometimes pulling desks together means that students are too far apart to talk in soft voices and still be heard by each other.
4. **Learning social skills** is essential if cooperative learning activities are to work well. There are basically two kinds of cooperative skills, those which students use to complete the task (e.g., asking questions, listening actively, staying on task), and those they use to build and maintain the working relationship of the group (e.g., disagreeing in an agreeable way, encouraging others, keeping things calm). Students need to be taught specific skills before they begin their group activity:
 - Decide which skills to work on. Concentrate on one or two at a time, depending on the age of the students and their previous experience in cooperative groups.
 - Help students understand why they are learning the skill, what the skill is (by modelling it, for example), how they can practise it, how well they use the skill, and how they can improve.
 - Students learning a second language, in particular, need to be taught specific vocabulary and structures for working in groups. For this reason, some of the specific outcomes deal with language functions involved in managing group actions.
 - Students need a variety of opportunities to practise the skill. This encourages them to transfer the skill to new situations.
 - In addition to providing feedback yourself, ensure that students evaluate their use of the skill both individually and as a group.
 - Assessment of the social skill should be part of the overall assessment of the activity.
 - Monitoring the groups as they work will show which cooperative skills are lacking and might become the focus in future lessons.

5. Group processing usually takes place at the end of the activity. Students discuss how well their group is functioning and how they may improve the group's effectiveness. This self-assessment may be done individually (e.g., "How did I contribute to the effectiveness of the group?") as well as in the group, and then shared with the rest of the class. Alternatively, one of the roles assigned in the group can be to monitor the use of a specific skill and report back to the group.
6. The kinds of roles assigned to group members depend on the task they are doing and on the skills they have already developed. Individual role cards, outlining the specific behaviours of each role, may be prepared as references for students while working in groups. Some examples of general roles are facilitator, recorder, encourager, observer, and summarizer. Some examples of roles that might be needed for specific tasks are materials handler, timekeeper, reader, and summarizer.

Tips

If students have little experience working in cooperative groups, start small with groups of two or three students. As they gain more experience and skill, they will be able to handle larger groups. The size of the group will also depend on the nature of the task.

When introducing cooperative learning, begin with a clear, concise task, simple roles, and basic social skills like talking with quiet voices.

It is usually better to group students with different levels of ability, different aptitudes, or different backgrounds. Each student's strong points will be different and each will be able to make a contribution to the group as well as learn from the others.

Students can stay in the same group for varying amounts of time, sometimes for only a few minutes, sometimes for a whole unit if they are working together on a particular task.

The teacher's role while groups are working is to observe student progress, record observations to provide feedback, and to intervene if necessary. When intervening, try to find ways to turn the problem back to the group members for a solution.

Students need time, practice, and explicit instruction to become good at working together cooperatively. Don't expect students to develop interpersonal skills automatically.

Applications

1. **Informal Groups**

Informal groups are usually small (two or three students) and short-term (a single activity or class). Groups can be formed very quickly by asking students to turn to their neighbour and do something together for a few minutes. Some examples of what students can do in informal groups are

- guided exercises such as practising dialogues and cloze activities
- brainstorm or come up with lists of words, ideas, and so on
- express a personal opinion on a film, a song, a current event
- give a brief report on strategies they have been trying, Internet sites they have visited, and so on

2. **Home Groups**

Home groups are often small as well, but are usually maintained for a long period of time, often throughout the whole course. It is important that members of a home group feel at ease with each other since they will be working together over an extended period of time. Students can be asked to name three or four other students they would like to work with and these suggestions can be used to constitute the home groups.

A home group provides on-going support, both socially and academically, for every member of the group. Learning a second language can be stressful for some students, but they will learn better if they are relaxed and confident.

Home groups can provide support to students in a number of ways:

- checking homework
- correcting notes
- studying for exams
- discussing strategies
- exchanging information about opportunities for using the language outside the classroom
- discussing problems

3. Jigsaw

The jigsaw method is a way of organizing cooperative learning groups to share the workload on larger projects. It involves several steps and two different kinds of groups.

- The students start in their home group or base group. The teacher explains how the project will be organized, outlines what the students' responsibilities are, teaches the social skills that will be worked on throughout the project, discusses assessment, and so on. Within the home groups, each student accepts to work on a particular aspect of the project, to become the "expert" on that part of the project for their group.

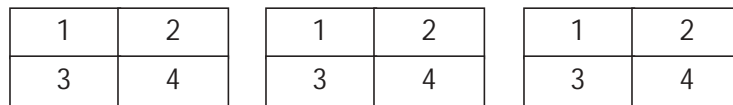

- Students from each home group who will be the "expert" for their group on the same topic come together to form expert groups. In their expert groups, they work on the particular aspect of the project they are responsible for, and decide how they will present this or teach it to the other members of their home group.

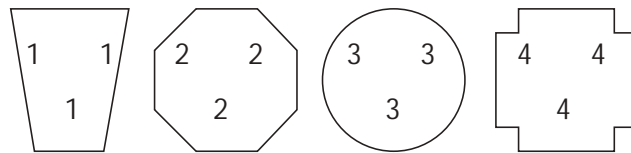

- Once students have finished the work in their expert groups, they return to their home groups, where they use what they have learned in their project, teach it to the others in the group, and remain the "expert" for their group on this particular topic.

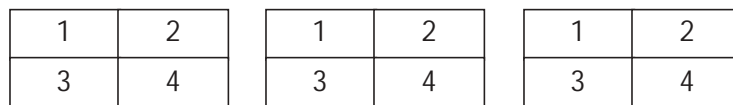

- The jigsaw technique is particularly useful for some of the tasks that students will be doing in a task-based language learning class.

Language Development

The language needed to work effectively in small groups can become an important component of a second language class, provided the time is taken to explicitly teach the vocabulary and structures necessary. Almost all of the functions set out in the Applications component of the curriculum guide will be necessary at some time or other in cooperative group activities.

It is important to make clear to students that communicating in Spanish is an expectation of their work in cooperative groups. Making it part of the assessment, assigning a language monitor as one of the roles, and teaching ways of helping each other are different ways of doing this.

Cultural Presentations

A cultural presentation is an exhibit that is focused on aspects of the target culture.

Students work in groups to create exhibits that represent a particular aspect of the target culture.

A cultural presentation is an effective tool to

- develop critical thinking skills
- develop the ability to select important high points
- encourage creativity and individuality
- deepen specific knowledge of the target culture

Ideas for Spanish Cultural Participation and Research Projects

If you like to draw, paint, build, cut, paste, or if you like the visual arts, consider the following:

- Make a map of a Spanish-speaking country or region. It should focus on a special topic such as agricultural products, manufactured items, costumes, geography, etc.
- Make a poster about a famous Spanish-speaking person (artist, scientist, political/historical person, athlete). Include a short biography and describe highlights of his/her career, when he/she lived, why important, etc.
- Imitate a famous Hispanic artist's painting or style in a painting of your own creation. Include a paragraph about the artist, which highlights his or her style of art and time period (Picasso, Velazquez, Goya, Miró, Rivera, Zurbarán are just a few starters).
- Make your own reproduction of a painting by a famous Hispanic artist. Include a paragraph about the artist, which highlights his or her style of art and time period (Picasso, Velazquez, Goya, Miró, Botero are just a few starters).

- On a map of North America, find concentrations of cities or natural features with Spanish names. Make a map, research the Spanish history of the area and include translations of names.
- Visit an online art museum (see web resources in the Appendices), and document Hispanic artists on display, giving titles of works, and writing your reactions to them. (If you like to sketch, quick sketches of a couple of the pieces you view would make great evidence!)
- Draw a comic strip to tell about an important historical event, famous person, or cultural practice.
- Visit a local or online gallery or exhibit featuring Hispanic artists, and document the art you saw there. Ideas for how to document the art include your own sketch of a piece of art which you like, videos, or photos (if you get permission from the exhibit managers before going there), a critique of what was good, bad, or interesting about the art you viewed, etc. (Check the entertainment sections of local newspapers and magazines to see what exhibits are available.)

If you like to cook or eat, consider the following:

- Go to a Spanish (or Guatemalan, or Peruvian, etc.) restaurant or café and order in Spanish. (Make sure someone speaks Spanish! Call to ask before you go!!) Get a signature on the menu or a business card. Document with video or photographs. Sample Spanish food you've never tasted before.
- Research what a typical dinner would be in a Spanish-speaking country. Make at least three courses for your family and/or friends. Document with copies of the recipes, and you **must have** photos or video.
- Cook a typical **main dish** of a Spanish-speaking area and bring samples to class. **Remember to bring utensils, napkins, etc.** (You'll bring this on a pre-arranged day and present it to the class.) You will need to sign up with the instructor prior to your presentation day. **Just salsa and chips is not acceptable.**
- Interview a Spanish speaker about customs at table such as how to hold utensils while eating, where to place hands while eating, what it's okay to eat with fingers, etc. Demonstrate to class.

If you can sew or use your hands well, consider the following:

- Sew a regional or historic Spanish costume. Document when and where the costume is from and who would wear this type of clothing. Model the costume for the class if it's full size. Bring the doll if you dress a doll.
- Build (using kits if you like) models of a famous building or monument of a Spanish-speaking country. Include a brief report about the monument or building. What is it called? When was it built? What was its purpose? Who had it built? What is it used for today if it has changed from its original purpose?

If you like to read or write, consider the following:

- Read a Spanish magazine or newspaper article (Yes, in Spanish!). Summarize the main points you learned in an outline or a graphic organizer. (See your teacher for magazines you can use. You can also find newspapers and magazines online.)
- Read a Spanish novel in translation.
- Read a Spanish children's book. Write a short plot summary in English and a list of new words learned. (There are lots in the library!)
- Read up on some aspect of Spanish culture (e.g., family, table manners, manners when visiting someone else, participating in sports, etc.), and then write a letter to a friend as though you were living in a particular Spanish-speaking culture and describing to your friend what life was like for you living there. There are great books available to use as resources. See your teacher for ideas.
- Read up on an aspect of a Spanish-speaking country's history and write a series of journal entries as though they were written by a person who had lived through them.
- Write to the tourist offices of various cities in a Spanish-speaking country requesting information. Submit a copy of your letter, materials received, and a write-up. Use these materials to decide where you would go on your ideal Spanish vacation, and present it visually (e.g., in a poster, an ad campaign to convince someone else to visit there, an "infomercial" video to be used as advertising for the area, etc.). Let your creativity be your guide for how to present what you learn.

- Using tourist resources such as guidebooks, travel agencies, and the Internet, plan your ideal vacation in Spanish-speaking parts of the world. Where would you go? What would you see? What kind of money would you pay in? What would there be to eat in the places you visit? What recreational activities? You may present this information as a travel journal pretending you've already completed the trip, as a travel agent's suggested itinerary for a customer, as though you're a travel writer telling people what to do, etc.
- After researching him or her, "become" a world leader of a Spanish-speaking country and tell the class who you are, why you're important, what you have accomplished, etc.
- Visit the Spanish section of an international bookstore. Describe what types of publications are available.
- Read up on an important event in the history of a Spanish-speaking country, and then write a news article as it might have appeared in the press at the time of the event. (This could be a scientific discovery, a battle, an invention, the defeat of the Spanish Armada, etc. Let your own interests be your guide.)
- Collect and read news articles about a Hispanic country in which you are interested, and then write an article yourself using the collected articles as resources.

If you like television, movies, or performing arts, consider the following:

- "Become" a famous Spanish speaker for the class. Wear an appropriate costume and introduce yourself to the class as that character. Explain what you did that caused you to become famous and when you did it, etc.
- Watch a Spanish movie with subtitles, summarize the plot, keep a list of words you figured out from the movie, and note the things you learned about Spanish culture from watching the movie.
- Memorize and perform a Spanish poem (or make a video of yourself performing the poem).
- Go see a Spanish play (classic or modern) or other musical or theatrical production. Summarize the plot, tell who the playwright or composer was, when (s)he wrote, etc.
- Learn to play or sing a Spanish song. Perform it, teach it to the class, or videotape it.
- Learn and teach a Hispanic dance to the class.
- Make a video to teach an aspect of the culture of a Spanish-speaking country or an aspect of Spanish grammar or vocabulary, or to reenact a scene from literature or history.

- Learn about various Spanish gestures and body language and make a video of yourself using those gestures with appropriate comments in appropriate situations or present them live to the class.
- Perform a scene from a Spanish play for the class in Spanish or English, but identify the playwright and time period.
- Read up on an important event in the history of a Spanish-speaking country, and then write a skit based on that event. (This could be a scientific discovery, a battle, a beheading, an invention, the defeat of the Spanish Armada, etc. Let your own interests be your guide.)
- Attend a concert or performance featuring Hispanic music or dancing.
- Visit a record store that carries a large selection of Hispanic music. Listen to songs available to listen to. Read about the songs. Report on what you learned, what you liked, etc.
- Listen to a mariachi band and talk to the band members. List the songs they played. Find out the names of their instruments in Spanish. Get an autograph from them.
- Watch MTV International with Daisy Fuentes, record or videotape songs in Spanish for the class, and complete a *teletarea* form (viewing log) for the viewing.
- Watch two hours of Spanish programming on local TV and fill out *teletarea* forms (viewing logs) for what you watched.
- Watch the news five times in Spanish and summarize the headlines on a *teletarea* form (viewing log).

If you like sports, consider the following:

- Learn the Spanish vocabulary for a sport commonly played in a Spanish-speaking region or country. Present your knowledge in a poster that includes illustrations and Spanish terms for key vocabulary, or teach the class the basics of the game in Spanish.
- Make a video for a sport with a narration in Spanish. (You may use a game from television and create your own narration for a five-minute period of the game.)
- Watch an hour of sports such as *lucha libre* or *boxeo* on Spanish-speaking TV, and complete a *teletarea* form (viewing log).
- Learn the Spanish vocabulary for a sport commonly played in Spanish-speaking countries. Teach the class the key vocabulary you learned.

Other possibilities include the following:

- Interview a native speaker about his or her country, using video or audiocassette.
- Make up a game for the class which requires the use of Spanish and knowledge of a Spanish-speaking country's culture for the game to be played. (Schedule a time with the teacher for it to be played in class.)
- Visit Hispanic stores in South Sacramento and summarize your activities, what you saw, what Spanish you got to speak, etc.

If you like computers, consider the following:

- Exchange five letters or emails with a native speaker of Spanish, and turn in copies of correspondence.
- Check out the weather on the Internet in several Spanish-speaking cities around the world. Show the locations of those cities on a map, and show what the weather was, using appropriate meteorological symbols and a map legend in Spanish.
- Make a list of cool Spanish-language websites you discover that can be duplicated for classmates. Give a brief description of what each site is about.
- Work with a language-learning program in Spanish and print out the lessons you have done as your evidence.
- Discover, read, interact with, and react to three Spanish-language web pages. (Include information you download from those pages as part of your documentation.) Your write-up will be crucial in convincing your teacher that you learned a lot and that this was a valid project.
- Design your own project based on something you discover on the Internet. Discuss your ideas in advance with your teacher to be sure it is acceptable. (The project must cause you to use Spanish and/or learn about a Spanish-speaking country's culture, not just print out what you find online).
- Visit a Spanish language catalog web site and put together your no-holds-barred holiday wish list. What are the names of the items you want? How much do they cost? In what currency? Is it something you'd find here?

If you are interested in business or in career opportunities using Spanish, consider the following:

- Interview a manager of a business operating locally that has its home or affiliated offices in a Spanish-speaking country. Learn what is involved in doing business between the two countries. Prepare your questions in advance and record your interview.
- Visit a local post-secondary institution offering Spanish courses, or a private Spanish-language institute where learning other languages to use in “the real world” is the focus.
- Research a career in which command of Spanish will be useful. (See your counsellor, a research librarian, or your teacher to discuss how to research this project.)
- Research a specific Hispanic business. In your write-up, profile the company (product, location, size of work force, gross sales, etc.) Try to contact someone working for the company you select (phone, email) and see whether he or she is willing to discuss with you how Spanish is useful to employees.
- Research the use of Spanish in an overseas business or nonprofit organization (e.g., health organizations, religious organizations, etc.) by interviewing someone who has used Spanish while living and working in a Spanish-speaking country. Also include questions to your interviewee about what it was like to live there and adjust to that culture.
- Job shadow someone who uses Spanish in the workplace for two hours.
- Interview Spanish translators who work for a translation company. (See the yellow pages to look for possibilities.)
- Visit the international sales department of a locally based export or international services business and learn how it conducts its international marketing and the steps and processes involved in international sales and in shipping product overseas.
- Interview an employee of a Spanish-speaking business about the challenges of doing business across cultures.
- Research and report on international management degree programs at schools such as the Monterey Language Institute, the American Graduate School of International Management, or the university of your choice. What career opportunities will such a degree bring you? What language requirements does the program have? What is their job placement rate for graduates, etc.?

- Interview people who use Spanish in their jobs, such as radio or television personalities, journalists (available through the *Bee* and *La Voz*), health care workers, law enforcement workers, etc. Find out why Spanish is useful to them. How good does their Spanish have to be to be helpful to them? How did they learn it? Why?

If you like to travel, consider the following:

- Photograph street and shop signs on a trip to Mexico; report on their significance. (You could do something similar with architecture, churches, types of stores, etc.)
- Visit Mexico and compare Spanish influences to Indian influences.
- Pretend to be a travel agent and plan an imaginary trip through a Spanish-speaking area. Use illustrations, maps, and texts to present this itinerary to your “client.”
- Visit a Spanish-speaking area and document your visit through videos or photographs to share with the class.
- Keep a travel log if you travel to a Spanish-speaking area.

If you like history and geography, consider the following:

- Visit a Spanish mission in California and learn about its history and architecture.

If you want to practice your Spanish, consider the following:

- Interview someone from a Spanish-speaking country about customs, traditions, holidays, attitudes, etc. in his/her country.
- Attend a *quinceañera*, *boda*, or *fiesta* in a Hispanic community.
- Attend a church service that is conducted in Spanish.
- Exchange three letters with a Spanish-speaking pen pal.
- Write a children’s book with illustrations and text in Spanish. The book should be based on something you have learned about Spanish culture, not American culture. (Alphabet and numbers books are not accepted.) See the teacher for ideas about an aspect of culture to incorporate into the story. It should be a story simple enough to tell in Spanish. (Don’t write it first in English!)

Information Gap

Definition

In an information gap activity, each person has certain information that must be shared with others in order to solve a problem, gather information, or make decisions.

Questions asked in second language classes are often “display” questions. In other words, the person asking the question already knows the answer and is, in effect, simply prompting his or her partner to demonstrate that they know the vocabulary in question. No real communication takes place. Information gap activities involve a real exchange of information, although the situation might be an artificial one.

Information gap activities are often done in pairs, although they can be teacher-led or involve groups of students.

Procedure

Information gap activities can be highly structured or fairly open-ended. In either case, they are most often used for reinforcement of previously learned vocabulary and structures.

- Explain the activity to the students. Make sure they understand that they cannot show the information to their partner. They must communicate verbally.
- If necessary, review the vocabulary and structures that will be needed to complete the activity.
- Once students have completed the activity, they can assess the accuracy of their communication by comparing the information they have.

Tips

When preparing the information gap activity, try to make the situation as realistic as possible so that the questions asked and the answers given are the same as or similar to what might happen in real-life situations.

Make sure that the students have a purpose for exchanging information, for example, a task to complete, a puzzle to solve, or a decision to make.

The first time you involve students in information gap activities, demonstrate in front of the whole class, so that students understand that they cannot just show their information to their partner.

Applications

Information gap activities can be organized in many different ways. The following are a few examples of activities involving pairs of students:

- Ask students to draw the same picture (e.g., a house) simultaneously. (Drawings may be done on adjacent computers using a drawing program.) Students must together choose where to draw the house, its size, what colour different parts are, and so on.
- Student A has a chart showing results of a survey (e.g., what time different people get up and go to bed), but some of the information is missing. He or she must ask student B, who has the missing information, in order to answer a question—who sleeps the longest?
- Student A has a map showing the location of a number of buildings. Student B must ask questions to find out how to get from where he or she is to the building they need to find (e.g., the post office [*el correo*]).

Communication gap activities can also involve groups of students:

- Students are asked to write a short text (e.g., a description of a family member). After they have gone through the usual process of drafting, writing, and editing, and the teacher has corrected the text, they rewrite the text with some information left out (e.g., Francisco has blue eyes and _____ hair. [*Francisco tiene los ojos azules y el pelo _____*]). Other students read the altered text and ask questions to fill in the missing information.
- Jigsaw activities are also information gap activities. For example, each student in the home group is given part of a text on the topic of the unit. The information in the text will usually be needed to complete a specific task. Together they have the whole text, but no single student has all the information. Students regroup with other students from different home groups who have the same part of the text, and they work together to understand all the information. They then return to their home group to share the information with the others and complete the task together.

Teacher-led information gap activities can involve the teacher asking questions for which he or she does not already know the answer. Alternatively, they might take the form of guessing games (e.g., Guess which classroom object is in the bag. Is it a pencil? Is it a notebook?).

Language Development

Information gap activities provide students with opportunities to practise vocabulary and grammar structures in more interesting ways. Motivation is usually high because forms and functions are used for a real, although contrived, exchange of information.

Interactive Language Tasks

In Interactive Language tasks, at least two students work together to accomplish a meaningful Spanish language activity.

The teacher organizes the class into small groups or pairs that then perform a specific task using language. Examples of tasks include finding differences and similarities, identifying objects or persons, arranging things, giving and following directions, interviewing, surveying, choosing, explaining, and solving problems.

Interactive language tasks are effective tools to

- foster interdependence and pursuit of mutual goals
- develop communication skills
- strengthen listening skills
- provide opportunities to use the target language

Language Experience

Definition

When using the Language Experience method, students experience something together, and have the opportunity to discuss it in detail. They then dictate sentences about the experience to the teacher who writes them down word for word. The text thus created is corrected, reread, and used for a variety of reading and writing activities.

Procedure

Begin with an activity or experience in which the students are all involved. It can be anything that the students do as a large group—a field trip, a shared story, baking something, doing a role play. Discuss the experience orally, encouraging students to recall and describe the event in as much detail as possible.

Then each student dictates a sentence about the common experience as the teacher writes it on large sheets of chart paper. The teacher models excellent writing skills, leaving space between the words, using upper and lower case letters appropriately and correct punctuation. It is helpful to go back frequently and reread what has been written. Ask students if there is anything they want to change. After everyone is happy with the content, go back and point out any errors and correct them together.

The text can then be used for a variety of reading and writing activities:

- The text can be typed and copies sent home to be shared with the family.
- The original text on chart paper can be posted in the classroom for the students to reread. It can also be rewritten as a book to be kept in the reading centre.

- Students can use words from the text in their own writing or to make personal dictionaries or word banks.
- Students can copy their own sentence or the whole text. They can add illustrations to help them recall the meaning.
- Cut the words apart and have the students put them back in the correct order.

Tips

It is important to accept the contributions of all students and to use their own words in the text. Errors can be corrected by the whole group together after the text is complete.

During the process of correcting the text, model the use of appropriate strategies such as using references to check spelling and grammar.

Keep the texts fairly short, especially for younger students.

This method can also be used with small groups or individuals, and is suitable for students of all ages.

Use this method to write texts of all kinds, including fiction.

Applications

This method is particularly effective for students who have some oral fluency, but have not learned to read or write the language. Students find the text easy to read because it is written in their own words. This, in turn, increases their self-confidence and their motivation to read more.

Students are motivated by this method because their own language and life experiences are valued. They can show the texts with pride because they have written them and are able to read them.

Use the Language Experience method to reinforce oral language and to teach reading. It is not suitable for introducing new concepts.

This method is also a way of producing texts for reading in situations where it is difficult to find texts that are at the appropriate level for students or on topics that are relevant and of interest to them.

Language Development

The Language Experience method is one of the most effective for teaching reading and for second language acquisition in general.

- It integrates listening, speaking, reading, and writing. The students are exposed to the vocabulary and structures in both written and oral form.
- By beginning with texts that the students themselves have composed, the reading and writing process is directly connected to the experiences and previous knowledge of the students.

- Students are able to build language skills such as word recognition using texts that are meaningful to them.
- Less proficient students benefit from working with texts that more proficient students have created about topics they are familiar with because they have shared in the experience.

The Learning Cycle

The Learning Cycle includes a sequence of lessons designed to have students engage in exploratory investigations, construct meaning out of their findings, propose tentative explanations and solutions, and relate Spanish language and culture concepts to their own lives.

The teacher engages the learners with an event or question to draw their interest, evoke what they know, and connect with new ideas. The students explore the concept, behaviour, or skill with hands-on experience. They explain the concept, behaviour, or skill and define the terms, then use the terms to explain their exploration. Through discussion, the students expand the concept or behaviour by applying it to other situations.

The Learning Cycle is an effective tool to

- encourage students to construct their own understanding of Spanish language and culture concepts
- promote empathy and understanding for people of other cultures
- provide hands-on experience to explore concepts, behaviours, and skills
- develop the ability to share ideas, thoughts, and feelings
- provide opportunities to use the target language

Surveys/Encuestas and Interviews/Entrevistas

Surveys and Interviews are methods for gathering information and reporting.

Students prepare a set of questions and a format for the interview. After conducting the interview, students present their findings to the class.

Surveys and interviews are effective tools to

- foster connections between ideas
- develop the ability to interpret answers
- develop organizational and planning skills
- develop problem-solving skills
- provide opportunities to use the target language

Definition

Students collect information from a sample of people to determine the frequency of particular responses. They then analyze the data and prepare a report on the results. Using surveys as an instructional method can also develop students' numeracy as well as their creative and critical thinking.

Procedure

The first time students do a survey, it is helpful to go through the procedure at least once as a whole class. After they have more experience, they will be able to plan and carry out a survey in small groups.

There are basically four steps to a survey: planning, collecting the data, organizing and displaying the data, and summarizing and interpreting the data.

1. The planning stage involves deciding which questions to ask, formulating the questions, deciding whether the questions will be asked orally (interview) or in writing (questionnaire), choosing the sample of people to survey, and dividing up the work among the students involved. It is at this step that explicit teaching or review of structures for asking questions may be needed.
2. The survey is then carried out in the agreed way. Students can survey other students in the class or school, people in the community, or even people in another community via email or telephone.
3. Once the data have been collected, they must be organized and displayed. The usual method for displaying survey results is some kind of graph. With a little planning in advance, a survey activity in the Spanish class can be integrated with what students are learning in mathematics class. Looking at a variety of different kinds of graphs and interpreting them will provide students with examples, ideas, and models of language to use.
4. Interpreting the findings of a simple factual survey is relatively easy. However, if the survey has gathered information about opinions or values, there is much more room for interpretation. Students may present their findings orally or in writing. In either case, they may benefit from analyzing other reports of the findings of surveys such as might be found in newspapers or magazines.

Tips

The language for reporting results of surveys is somewhat different from ordinary conversation. Students need to see and analyze reports on survey results to discover typical ways of organizing texts of this type, typical sentence patterns, as well as some specialized vocabulary.

Applications

A survey can be carried out on almost any topic. The information gathered can be strictly factual (e.g., month and year of birth, number of people in the family), or it can be more subjective (e.g., likes and dislikes, opinions on a specific topic).

The kind of graph used to represent the results can vary with the age and level of mathematical understanding of the students.

Language Development

Surveys are useful for language development because they provide an opportunity for repetition in an activity where there is a focus on meaning and a purpose. They also provide a natural context for asking questions, using numbers, and making comparisons. If graphs or other visual representations of the results are prepared by students, outcomes for viewing and representing can also be achieved.

Debate

A debate is a discussion in which arguments are presented for and against a statement or resolution. The debate topic begins with “*Que se tome la resolución de . . .*” Debates can take place between two people, or two teams, or can involve an entire class. One side defends the resolution by taking the affirmative view, while the other side (the opposition) argues against the resolution.

Problem Solving

Problem Solving is a learning method in which students apply knowledge to solve problems.

The students discover a problem; problems can be constructed by the teacher or can be real-world problems suggested by the students. The students define the problem, ask a question about the problem, then define the characteristics of possible solutions, which they research. They choose a promising solution that best fits the criteria stated in the definition of solutions, and then test the solution. Finally, they determine if the problem has been solved.

Problem solving is an effective tool to

- allow students to discover relationships that may be completely new to them
- adapt easily for all grade levels and special needs students
- develop the ability to construct new ideas and concepts from previously learned information, skills, and strategies
- promote communicative competence in Spanish

Independent Study

Students should be able to continue to learn after they have left the structured learning environment of the school. If the knowledge, abilities, attitudes, and processes associated with independent learning are to be acquired, they must be taught and enough time must be provided for students to practise.

Independent study is very flexible. It may be initiated by student or teacher; it can include learning in partnership with another individual or as part of a small group. It can be used as the major instructional strategy with the whole class, in combination with other strategies, or it can be used with one or more individuals while another strategy is used with the rest of the class.

It is important to assess the abilities students already possess. Specific skills and abilities may then be incorporated into assignments tailored to the capabilities of individual students.

Computer-Assisted Instruction

This method refers to any instructional program in which the computer performs, manages, or supports some or all of the teacher functions.

Logs and Journals/Diarios de registro o Diarios

Logs and journals can be used as a way to hold private conversations in Spanish with the teacher. Dialogue journals are vehicles for sharing ideas and receiving feedback in Spanish. This dialogue can be conducted by email where it is available.

Students write on topics on a regular basis, and the teacher responds with oral or written advice, comments, and observations in a conversation. In the early stages of learning a language, students can begin by adding a few words and combining them with pictures.

Logs and journals are effective tools to

- develop communication and writing skills
- create a positive relationship between the teacher and the student
- increase student interest and participation
- allow the student to direct his or her own learning
- provide opportunities to use Spanish

Definition

A journal is a notebook in which students record their personal reflections, questions they are wondering about, ideas, words or expressions they want to remember, or feelings they have about experiences in class. Logs are usually more objective, for example, observations on learning activities, lists of books read or films watched, notes on learning strategies, and so on.

Procedure

If students have little or no experience using a log or journal, it is a good idea to model the process by doing a collective journal on large chart paper. Begin by discussing the reasons for keeping a journal and ways it can be used, so that they can better understand the process and the purpose.

- Always begin by noting the date of the entry.
- Specific questions can be asked, especially when students are new to journal writing, to give them some guidance about the kinds of things to write about.
- Provide regular opportunities for students to write in their journals, for example, a few minutes before or after an activity depending on what they are writing about.
- Students choose whether or not to share their journal entries with the teacher or their fellow students.
- If students do decide to share parts or all of their journal, teachers can respond individually with questions or comments to extend thinking. Since the primary purpose of the journal is not to practise writing, teachers should not correct the grammar, spelling, or punctuation in student journals.
- Encourage students to regularly reread what they have written in their journals and reflect on it.

Tips

When doing a collective journal, be sure to go through all the steps of journal writing, including reflection on previous entries, so that students have a model at all stages.

Some students need more guidance in journal writing. They can be given specific questions to answer or sentence stems (e.g., *Mi parte favorita del día es ...*) to get them started.

Although journals are not usually evaluated, they can be a source of useful information and can help the teacher guide the student's learning.

If students are having difficulty expressing their thoughts in words, suggest that they add drawings or other visual representations to express their meaning.

Applications

The different types of journals and logs have different purposes and are used in different contexts.

1. **Personal Journals/*Diario personal***

- Personal journals are often used for students to record their emotional reactions to learning the language and experiencing the culture, and to note their aspirations for travel, education, or other personal uses of their knowledge about the language and culture.
- Students should be reassured that their writing will remain private if they so wish.
- The personal journal can be particularly effective for reflection on experiences with a new culture, since reactions to different ways of doing things are often of an emotional nature rather than intellectual.

2. **Dialogue Journals/*Diario comunicativo***

- Dialogue journals are for journal writing in situations where another person, often the teacher, responds to what the student has written. The resulting journal resembles a conversation in written form.
- The teacher's response to what the student has written should focus on the content rather than the language. The response can be in the form of comments or questions which encourage the student to extend their thinking or reflect on their experience.
- Respond regularly to journals. Other students, parents, or other interested persons can also respond to dialogue journals. Make sure they understand the purpose of the journal and are able to respond in a respectful and thoughtful manner.

3. **Learning Logs/*Diario de aprendizaje***

- Learning logs are very useful for increasing the students' awareness of how they learn (metacognitive learning strategies) and thus developing their strategic competence.
- Students benefit from discussion about what they are learning, why they need to know specific aspects of the language or culture, and how they are learning. The discussion helps them develop the language they need to write effectively about their learning and problem-solving processes.

- Some questions that might be used include the following: What do you know now that you did not know before? What was most difficult about today's class? Why was it difficult? Have you had this problem before? If so, what did you do to resolve it last time? What could you try in future? What do you want to concentrate on in the next class? / *¿Qué sabes ahora que no sabías antes? ¿Qué fue lo más difícil en la clase de hoy? ¿Por qué fue difícil? ¿Antes tenido este problema antes? Si es así, ¿qué hiciste para resolverlo la última vez? ¿Qué podrías tratar de hacer en el futuro? ¿En qué quieres concentrarte la próxima clase?*

4. Reading Logs/*Diario de lectura*

- Reading logs are used to help students learn to think about and respond to what they are reading, make connections between their own experience and the story, and generally develop a love of reading.
- Beginners or young readers may simply draw a picture of one of their favorite scenes from the story and add a simple caption.
- As students become more skilled readers and writers, they can write about what they think the story will be about, based on the cover and illustrations, their first impressions when they start reading, and then their reactions as they discover whether or not their hypotheses were correct.
- They can also comment on the language, for example, new words, things they do not understand, interesting words or phrases, aspects of the style (figurative speech, colloquial expressions, etc.).
- Some questions that might be asked include the following:
 - *Si tú hubieras escrito esta historia, ¿hay algo que cambiarías?*
 - *¿Qué te gustó más de este libro?*
 - *¿Te ha sucedido algo parecido alguna vez?*
 - *¿Has leído alguna vez otros libros sobre el mismo tema (por el mismo autor)? ¿Cuál prefieres?*

Language Development

Although the primary goal of journal writing is not to teach the language directly, there can be many benefits of this method for language development. In their journals and logs, students have an opportunity to use language in a different context, as a personal tool for learning. It is also very useful for developing strategic competence and intercultural competence.

Free Writing

Free Writing is a method for encouraging students to express ideas by writing in Spanish.

After reflecting on a topic, students respond in writing for a brief time to a Spanish prompt, a quote, or a question.

Free writing is an effective tool to

- develop the ability to link previous knowledge and experience to a topic
- develop creative and critical thinking skills
- provide opportunities to express and share ideas in written form
- encourage students to value writing in the target language

Personal Dictionaries/Diccionarios personales

Personal dictionaries consist of words that are familiar and significant to students. These words, which students use frequently in oral contexts, can form the basis of reading and writing vocabularies. Word sources included dictated stories and captions, journals and other writing efforts, as well as students' own oral vocabulary. For language learning, personal "banks" or collections of key words are valuable resources. Students may compile word collections to expand their reading and writing vocabularies.

Learning Contracts/Contratos de aprendizaje

Students and teacher work together during the designing, running, and evaluation of personal contracts. Learning contracts may be used to guide students as they work towards outcomes related to using Spanish for fun and personal enjoyment, for example, or the development of metacognitive strategies.

Research Projects/Proyectos de búsqueda

Students may be involved in research projects individually, as partners, or as members of small groups. Research projects are effective in developing and extending language skills. While doing research, students practise reading for specific purposes, recording information, sequencing and organizing ideas, and using language to inform others.

A research model provides students with a framework for organizing information about a topic. Research projects frequently include these four steps:

- determining the purpose and topic
- gathering the information
- organizing the information
- sharing knowledge

Experiential Learning Methods

Experiential learning methods are student-centered. The emphasis is on process, not product.

Experiential instruction strategies are very useful because

- they greatly increase understanding and retention
- students are more motivated because they actively participate and teach one another by describing what they are doing
- they are inductive—illustrations or examples are given and a rule, concept, or generalization is then formulated
- they are activity oriented
- students reflect about an experience, and apply what they have concluded to other contexts

There are five phases:

- experiencing (an activity occurs)
- sharing (reactions and observations are shared)
- analyzing (patterns are determined)
- inferring (concepts are developed)
- applying (plans are made to use learning in new situations)

TPR Storytelling

Based on the Natural Approach, TPR Storytelling combines the effectiveness of TPR with the power of storytelling. TPR Storytelling teaches students to use the vocabulary they have learned in the context of entertaining, content-rich stories. Language production goes beyond the imperative into the narrative and descriptive modes.

The following is a brief outline of the sequence of steps for TPR Storytelling:

Step One: Use TPR Practice and Scenarios to Teach Vocabulary

The teacher uses TPR to teach a small group of words. After introducing a word and its associated action, she “plays with” the vocabulary in TPR practice to provide more comprehensible input. Using gestures, manipulatives, pictures, and familiar vocabulary, she then further reinforces new vocabulary by giving students a series of commands to execute and short scenarios to act out.

For example, in a beginning-level story from textbook *¡Cuéntame más!* (Marsh and Anderson), the following vocabulary items are taught via TPR: the coyote, sees, the bird, wants to eat, grabs, offers. Sample commands might include the following:

Come.

Come un plato grande de espinacas. (¡Aj!)

Come cuatro barquillos de helado. (¡Oh, qué rico!)

Come un pájaro pequeño y un coyote grande.

Agarra al coyote.

Ofrécelo a los estudiantes a tu derecha.

Ofrece un pájaro grande a ese estudiante.

Agarra un coyote y ponlo encima de la cabeza de ese estudiante.

Etc.

After practice with short commands, a sample scenario, which students act out while the teacher narrates, might look like this:

There is a tiny bird. (*El “estudiante pájaro” hace una reverencia y saluda “pío, pío.”*) There is a big coyote. (*El “estudiante coyote” hace una reverencia y “aulla.”*) The big coyote had four sandwiches. The tiny bird wants to eat the sandwiches, so the coyote offers the bird two sandwiches. Yum!

Step Two: Students Produce and Practise Vocabulary Words

Once students have internalized vocabulary words through TPR practice and scenarios, the class divides into student pairs to practice the words. One student in the pair reads the word and the other gives the corresponding gestures, then vice versa. Next, one student does the gesture and the other says the corresponding word.

Step Three: Teacher Presents a Mini-Story that Students Then Retell and Revise

Using student actors, puppets, or pictures from the text, the teacher then narrates a mini-story containing the targeted vocabulary words.

The mini-story and illustrations corresponding to the above vocabulary words are as follows:

There is a big coyote. There is also a tiny bird. The coyote sees the bird. The coyote wants to eat the bird. The coyote grabs the bird. Oh no! But the bird offers the coyote a peanut butter sandwich. What a relief! The teacher uses a variety of techniques to increase exposure to the story and to help the students start telling it:

1. She pauses in the story to allow students to fill in words or act out gestures.
2. She makes mistakes and lets the students correct her.
3. She asks short-answer and open-ended questions. (Is the coyote long or little? Who does the coyote grab? What is the coyote's name? Where does he live?)

Once the story is internalized, students then retell it to a partner. Students may tell the story from memory or may use illustrations or guide words written up on the board as cues. The class then reconvenes and student volunteers retell the story for other students to act out. The teacher may also help the class revise the story, changing a few details about the plot or characters to create a new revision to the original story line.

Step Four: Teacher Presents a Main Story that Students Retell and Revise

Small groups of mini-stories are designed to prepare students to narrate, read, and write a larger main story that uses the vocabulary from the mini-stories. When the entire group of mini-stories has been mastered by the class, the teacher then repeats Step Three to introduce the main story. Once the main story has been presented and acted out, it is reinforced with readings and exercises from the textbook. As with mini-stories, students build upon the main story, using their existing language skills to embellish the plot, personalize the characters, and create revisions.

Step Five: Students Use New and Old Vocabulary to Create Original Stories

Capitalizing on their creativity, students are given opportunities to write, illustrate, act out, and share original stories. Activities may include drama, essays, videotaping, creating student booklets, contests, group/pair work, illustration exercises, back-to-back communication activities, etc.

These are the simple steps at the heart of a complete and comprehensive methodology that allows students to rapidly acquire, internalize, and produce sophisticated language in a fully communicative approach.

Field Trips/Excursiones

This activity allows students to use their language skills in a realistic setting outside the classroom.

A field trip is a planned learning experience for students to observe, study, and participate in expressions of the target culture(s) in a setting off the school grounds, using the community as a laboratory.

Before the field trip, teachers and students plan and structure communicative activities to engage in during the visit and engage in follow-up activities after the trip.

Field trips are an effective tool to

- develop organizational and planning skills
- develop observational skills
- give students an authentic experience of communicating in a foreign language

Focused Imaging/Enfoque imaginativo

This method is the process of internally visualizing an object, event, or situation. It enables students to relax and allow their imaginations to take them on journeys, to experience situations vicariously, and to respond with their senses to the mental images formed.

Games/Juegos

Games are structured or contrived learning or training activities that include conflict, control, and rules for winning and terminating the activities.

Role Play and Simulation/Dramatizaciones y simulaciones

Definition

Children naturally use make-believe to explore a whole variety of roles and situations that, as children, they cannot experience directly. Role play and simulation are methods that use this natural learning strategy to explore different aspects of school subjects. Role play and simulation are both related to drama, but they resemble improvisation more than play-acting or other theatrical performances. Students assume a role (a character, a real-life or imaginary person, sometimes even an animal) and are put in a situation or context. When they assume roles, they are acting “as if” they are someone else. They are experimenting with what it feels like to be in someone else’s shoes and developing empathy with those other lives.

Although some props may be used, generally there is no set, no costumes or makeup, and no script. Students do not try to physically resemble the person they are playing, but they do behave the way they think that person would behave. Role play does not involve writing a skit, and then reading or memorizing it and performing it before an audience. Students are given a role, placed in a situation, and required to act as that person would act in real life. Simulation differs from role play in that it is a more extended and more complex activity and may involve a variety of activities including role-play.

Procedure

Although the kinds of situations used in role plays and simulations are very diverse, the basic procedure is the same. This method is best used at the reinforcement or review stage of learning, when students have a fairly good command of the vocabulary and structures, but need some practice using them in relatively unstructured situations.

Begin by outlining the situation. As students gain more experience in role play, they can take a more active role in planning and guiding the situation. There is usually a problem of some kind that needs to be solved, a conflict that needs to be resolved, or a situation that involves an unforeseen element.

Students may need a period of time for research before they actually do the role play in order to properly play their role. This does not mean writing out a dialogue to deliver. It simply means knowing the background, experiences, beliefs, and opinions of the characters they are playing.

During the role play itself, sometimes everyone is in role, even the teacher. The role assumed by the teacher will vary depending on the amount of guidance the students need. At first, assuming roles such as chairperson of a committee or meeting, spokesperson for a group of protesters, or chief investigator for an enquiry will allow the teacher to guide the role play and encourage students to participate. As the students become more familiar with this method, they can take on some of the more dominant roles in the situation. There should be a clear distinction between being "in role" and "out of role." A signal can be pre-arranged (for example, the teacher puts on and takes off a hat) to indicate the beginning and the ending of the role play.

The period of reflection which follows the role play is just as important as the role play itself. At this stage students describe what they experienced and how they felt. The teacher guides the discussion by asking questions and making comments, encouraging the students to think about their experience. Students may also respond by drawing pictures to express their experience.

Tips

Students need to do a variety of activities before the role play in order to acquire the vocabulary and structures they will need to communicate in the situation they are given. The role play itself provides an opportunity to practise using this vocabulary and these structures in realistic situations, in other words, to bring together and fine tune their previously acquired knowledge.

It is often helpful to incorporate an element of tension into the situation. This “pressure for response” can take the form of a challenge, a surprise, a time constraint, or the suspense of not knowing. Tension is what works in a drama to impel the students to respond and take action.

Applications

Role play is a natural extension of the traditional methods of reading or memorizing dialogues, or of writing skits consisting of short conversations. The advantage of role play is that it places students in a situation which more closely resembles real life, situations where they do not know exactly what the other person is going to say. Role play also provides opportunities to develop other knowledge, skills, and attitudes, depending on the situation. The following examples are only meant to suggest some of the possibilities:

- Begin by role-playing fairly routine situations like asking for directions using a map, ordering a meal in a restaurant from a menu, or buying something in a store. The students must play their roles without a script or a pre-determined dialogue. Gradually introduce variations into the situations; for example, the customer in the restaurant wants something that is not on the menu, or the store clerk is very insistent.
- Students work in pairs, one playing the role of interviewer, the other the person being interviewed. The person being interviewed may be a real person, a character from a story, or a person in a particular role such as the mayor of a large city. The interviewer should have a specific focus for the interview, a particular event to discuss, or a point of view on a particular topic. Both students will need time to prepare for the role play, but they should not write out the interview in advance.
- Imagine a situation, typical of those experienced in the country of origin, which provided the impetus to emigrate to Canada. Role-play a family discussion where some members of the family want to leave and others want to stay. This could be followed by another role play of the same family five years later, after they have moved to Canada. Is the experience what they expected?

- Present students with a case study of a cultural misunderstanding. The source of the misunderstanding could be anything from misinterpretations of gestures, inappropriate use of informal forms of address, or politeness conventions to more fundamental differences based on underlying values or common experiences. Have students role-play the situation, trying to find ways to resolve the misunderstandings. It is also useful for students to experience the same situation more than once but in different roles.
- Situations can be purely whimsical, for example, a meeting to plan for the first voyage to colonize the moon. Students would play the role of colonists, each with individual characteristics, and would have to decide what to take with them, given specific restrictions for volume and weight.

Language Development

Role play is an interactive instructional method and is very effective in developing interactive fluency. Simulation, because it is a more extended and more complex activity, can also involve oral and written interpretation and production. Part of the development of interactive fluency is the acquisition of interactive language use strategies. Discussion of the use of strategies can form part of the reflection process that follows the role play.

Role play allows students to use the Spanish language in a variety of sociocultural contexts that they would not normally encounter in the classroom. This would provide practice interpreting and using language in different registers (different levels of formality), incorporating appropriate methods of non-verbal communication and different social conventions.

The situations and functions (applications) that students can experience during role play and simulation can include conflict situations, problem solving, expressing strong emotions, and other situations that may not arise naturally in classroom interaction. Students have the opportunity to practise their ability to deal with these situations in a safe environment.

Role play and simulation also offer unique opportunities for developing intercultural competence if the situations involve exploring cultural differences, adapting to new situations and ways of doing things, and taking a variety of perspectives. Students can, for example, experience the same situation several times, playing a different role each time.

Combined Grades in the Second Language Classroom

Combined grades is defined as grouping more than one grade level at the same time with one teacher. This situation in the second language classroom is common, especially when the program is new and becoming established within a school program. The term “split grade” is sometimes used interchangeably with “combined grade” or “multigrade.” It is important to note, though, that the term split grade implies separate grades which are taught separately without a connection to the other grade. In a combined grade classroom it is possible for the students to be taught parts of the curriculum together.

Are There Benefits to a Combined Class?

Teachers may feel uncomfortable with teaching a combined class. However, there are many benefits to teaching a combined grade class. There have been educational studies done documenting combined grade classrooms. Studies consistently show that there is no significant achievement difference between students in a one grade classroom and students in a combined grade classroom.

There are other benefits to combined grade classrooms:

- There is social interaction between students of different ages. Through this, the older students develop a sense of responsibility, and the younger students can be challenged and given the opportunity to move ahead.
- It enables students to work at different levels in a way that is not obvious to the other students. For example, an older student with weaker skills can participate effectively and contribute to the group.
- It helps develop independent learning skills and self motivation in students.
- Older students are able to review and internalize their learning through participation in cooperative learning groups.
- The curriculum is taught in a more contextual and thematic manner. This gives the students a more wholistic approach to language learning.
- It increases student confidence in their abilities.
- When a new concept is introduced to one grade level, it is practised or reinforced by the other grade level.

Planning for the Combined Grade

The key to a successful combined grade experience is the process of using effective strategies for instruction and effective planning. The following are successful strategies which will effectively organize planning for instruction.

Thematic Planning

For thematic planning strategies see Planning for Instruction and Assessment, pages 9–11.

Cycling Areas of Experiences

Cycling areas of experiences means that the teacher covers different areas of experience each year for the class as a whole. For example, the Grade 8 and 9 Spanish class will cover certain themes one year and different ones the following year. This will work well if you know that your combined grade class will continue together for a few years.

Combining Concepts

This strategy means that the teacher will combine areas of the curriculum which have similarities and overlap from one grade to the other. The students work together in a variety of activities because curricular outcomes are combined.

When the grammatical elements or certain concepts do not match and the teacher needs to spend time with a particular group there are certain modifications in instructions which may be done. For example, one group may be given a task to do while the teacher is focused on instructing the other grade. The teacher may have a long term project for each grade which may be worked on independently while the teacher instructs the other grade.

Organizational Strategies for the Combined Grade Classroom

Use Cooperative Learning Groups

A combined grade classroom lends itself very well for cooperative learning groups. When organizing these groups the teacher will often put the different grades together (i.e., Grade 8/9 students will sit together in a group). This way the students work together in a mutually beneficial manner. It is this interdependence that is the key to success in a cooperative learning group.

For interactive instruction methods that involve students working in small groups, see pages 76–77 of this section.

Build an Inviting and Positive Atmosphere

The teacher will create a learning environment which is accepting of differences. Students of all levels need to feel that their opinions are valued and that they have an important place in the class. One way the teacher builds a sense of community in the class is through activities which help students work as a team and encourage student participation.

See pages 72–78 of this section.

Assessment and Evaluation in the Combined Grade Classroom

Whether it be in a single grade or a combined grade class, effective assessment practices do not differ. When evaluating a student, it is vitally important that the teacher understand the outcomes and the philosophy of the curriculum. When assessing and evaluating students in a combined grade the teacher may need to adapt certain methods used. The teacher will still need to teach concepts separately and monitor student progress accordingly. Also, the teacher will need to evaluate each student according to the particular curricular outcome for the student's grade.

See Classroom Assessment, pages 9–26, for Assessment and Evaluation strategies.

The situation of having different levels in one classroom is not new. Every teacher has this situation in the classroom. Therefore, effective teaching strategies in the single grade classroom are not different from these strategies in a combined grade classroom.

However, it is critical that that the teacher have access to resources for the range of students in the classroom. The teacher needs appropriate planning time to adapt lessons or units in cases where the concepts are similar to the different grades in the class.

Notes